

Keysight PP0001 A/2A/3A Hi-Z+ Passive Probes and PP0004A Hi-Z+ Adapter

User's Guide



Distributed by:

Sie haben Fragen oder wünschen eine Beratung? Angebotsanfrage unter **07121 / 51 50 50** oder über **info@datatec.de**

dataTec

Notices

© Keysight Technologies, 2021

No part of this manual may be reproduced in any form or by any means (including electronic storage and retrieval or translation into a foreign language) without prior agreement and written consent from Keysight Technologies, Inc. as governed by United States and international copyright laws.

Manual Part Number

PP0002-97000

Edition

First Edition, January 2021

Published by:
Keysight Technologies, Inc.

1900 Garden of the Gods Road
Colorado Springs, CO 80907 USA

Warranty

The material contained in this document is provided “as is,” and is subject to being changed, without notice, in future editions. Further, to the maximum extent permitted by applicable law, Keysight disclaims all warranties, either express or implied, with regard to this manual and any information contained herein, including but not limited to the implied warranties of merchantability and fitness for a particular purpose. Keysight shall not be liable for errors or for incidental or consequential damages in connection with the furnishing, use, or performance of this document or of any information contained herein. Should Keysight and the user have a separate written agreement with warranty terms covering the material in this document that conflict with these terms, the warranty terms in the separate agreement shall control.

Technology Licenses

The hardware and/or software described in this document are furnished under a license and may be used or copied only in accordance with the terms of such license.

U.S. Government Rights

The Software is "commercial computer software," as defined by Federal Acquisition Regulation ("FAR") 2.101. Pursuant to FAR 12.212 and 27.405-3 and Department of Defense FAR Supplement ("DFARS") 227.7202, the U.S. government acquires commercial computer software under the same terms by which the software is customarily provided to the public. Accordingly, Keysight provides the Software to U.S. government customers under its standard commercial license, which is embodied in its End User License Agreement (EULA), a copy of which can be found at

<http://www.keysight.com/find/sweula>. The license set forth in the EULA represents the exclusive authority by which the U.S. government may use, modify, distribute, or disclose the Software. The EULA and the license set forth therein, does not require or permit, among other things, that Keysight: (1) Furnish technical information related to commercial computer software or commercial computer software documentation that is not customarily provided to the public; or (2) Relinquish to, or otherwise provide, the government rights in excess of these rights customarily provided to the public to use, modify, reproduce, release, perform, display, or disclose commercial computer software or commercial computer software documentation. No additional government requirements beyond those set forth in the EULA shall apply, except to the extent that those terms, rights, or licenses are explicitly required from all providers of commercial computer software pursuant to the FAR and the DFARS and are set forth specifically in writing elsewhere in the EULA. Keysight shall be under no obligation to update, revise or otherwise modify the Software. With respect to any technical data as defined by FAR 2.101, pursuant to FAR 12.211 and 27.404.2 and DFARS 227.7102, the U.S. government acquires no greater than Limited Rights as defined in FAR 27.401 or DFAR 227.7103-5 (c), as applicable in any

technical data. 52.227-14 (June 1987) or DFAR 252.227-7015 (b)(2) (November 1995), as applicable in any technical data.

Safety Notices

CAUTION

A **CAUTION** notice denotes a hazard. It calls attention to an operating procedure, practice, or the like that, if not correctly performed or adhered to, could result in damage to the product or loss of important data. Do not proceed beyond a **CAUTION** notice until the indicated conditions are fully understood and met.

WARNING

A **WARNING** notice denotes a hazard. It calls attention to an operating procedure, practice, or the like that, if not correctly performed or adhered to, could result in personal injury or death. Do not proceed beyond a **WARNING** notice until the indicated conditions are fully understood and met.

Contents

1 Overview

Introduction **6**

PP0001A/2A/3A Probes 6

PP0004A Hi-Z+ Adapter for PP0001A/2A/3A Probes 7

Compatibility with Keysight Oscilloscopes **8**

Standard Accessories **9**

Orderable Accessories **10**

2 Characteristics and Specifications

Electrical Characteristics **12**

Environmental Characteristics **13**

Mechanical Characteristics **14**

Accessories Dimensions 14

PCB Adapters Footprints and Solder Layouts 15

3 Setting up and Using PP0001A/2A/3A Probes

Adjusting the Probe for Frequency Compensation **20**

Connecting the Probe to an Oscilloscope **22**

Using Channel Identification Rings 22

Making DUT Connections using Probe Accessories **23**

DUT Connectivity Options for PP0001A and PP00002A Probes 24

DUT Connectivity Options for PP0003A Probe 29

4 Safety and Regulatory Information

Safety Checks and Warnings **32**

Instrument Markings and Symbols **34**

Cleaning the Probe **35**

5 Performance Plots

Derating Curve **38**

Input Impedance **39**

6 Returning the Probe for Repair/Service

Contacting Keysight Technologies for Technical Assistance 44

Index



1 Overview

Introduction	6
PP0001A/2A/3A Probes	6
PP0004A Hi-Z+ Adapter for PP0001A/2A/3A Probes	7
Compatibility with Keysight Oscilloscopes	8
Standard Accessories	9
Orderable Accessories	10

Introduction

PP0001A/2A/3A Probes

The following three passive probes and their standard and orderable accessories are described in this guide.

PP0001A	PP0002A	PP0003A
		
1 GHz, 300 Vrms Hi-Z+ passive probe	800 MHz, 1200 Vrms Hi-Z+ passive probe	1 GHz, 30 Vrms Hi-Z+ passive probe
Comes with a replaceable probe tip cartridge as displayed in the above figure	Comes with a replaceable probe tip cartridge as displayed in the above figure	Comes with a fixed pre-installed probe tip as displayed in the above figure
BNC output connector	BNC output connector	BNC output connector
Requires the use of the PP0004A adapter to connect to the compatible Keysight oscilloscopes (see page 8) (The adapter's AutoProbe interface provides the probe power, probe offset, and auto configuration of probe type and attenuation setting on connection.)		
-	-	Supports MMCX connection directly
Low capacitance	Low capacitance, high voltage	Low capacitance
Provides a simplified software-controlled frequency compensation procedure (see page 20)		
A variety of accessories including different probe tip adapters are available for these probes to suit different types of target boards and to make connections to compact probing locations (see page 9 for supplied and orderable accessories).		
Additional accessories kits are also available that you can order separately (see page 10)		

CAUTION

Before using these probes, refer to **"Safety and Regulatory Information"** on [page 31](#).

PP0004A Hi-Z+ Adapter for PP0001A/2A/3A Probes

The PP0004A adapter is also described in this guide.

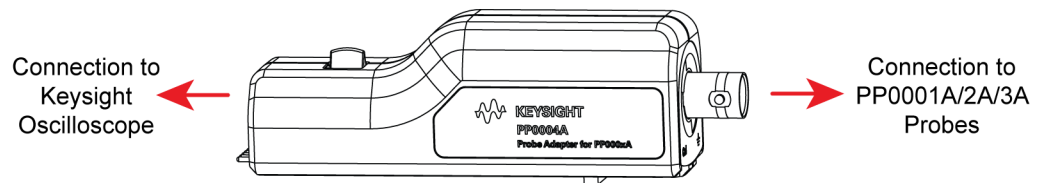

CAUTION

Always use the PP0004A adapter when connecting the PP0001A/2A/3A probes to a compatible Keysight oscilloscope.

Do NOT use the PP0004A adapter with any probe other than PP0001A/2A/3A probes. The PP0004A adapter has been specifically designed for the PP0001A/2A/3A probes to work with the compatible Keysight oscilloscopes.

Compatibility with Keysight Oscilloscopes

Compatible Oscilloscopes	Adapter(s) Required	Required Software Version
Infiniium Oscilloscopes		
UXR-Series (with AutoProbe II interface)	PP0004A + N5442A	11.10 or higher
MXR-Series	PP0004A	11.10 or higher
EXR-Series	PP0004A	11.10 or higher
S-Series	PP0004A	6.60 or higher
90000 Q, V, Z-Series	PP0004A + N5442A	6.60 or higher
InfiniiVision Oscilloscopes		
3000T X-Series	PP0004A	7.40 or higher
4000 X-Series	PP0004A	7.40 or higher
6000 X-Series	PP0004A	7.40 or higher

Is your oscilloscope software up-to-date?

Keysight periodically releases software updates to support your probe, fix known defects, and incorporate product enhancements. To download the latest firmware, go to www.Keysight.com and search for your oscilloscope's model number. Click the "Drivers, Firmware & Software" tab under the **Technical Support** link.

Standard Accessories

PP0001A Probe - Standard Accessories

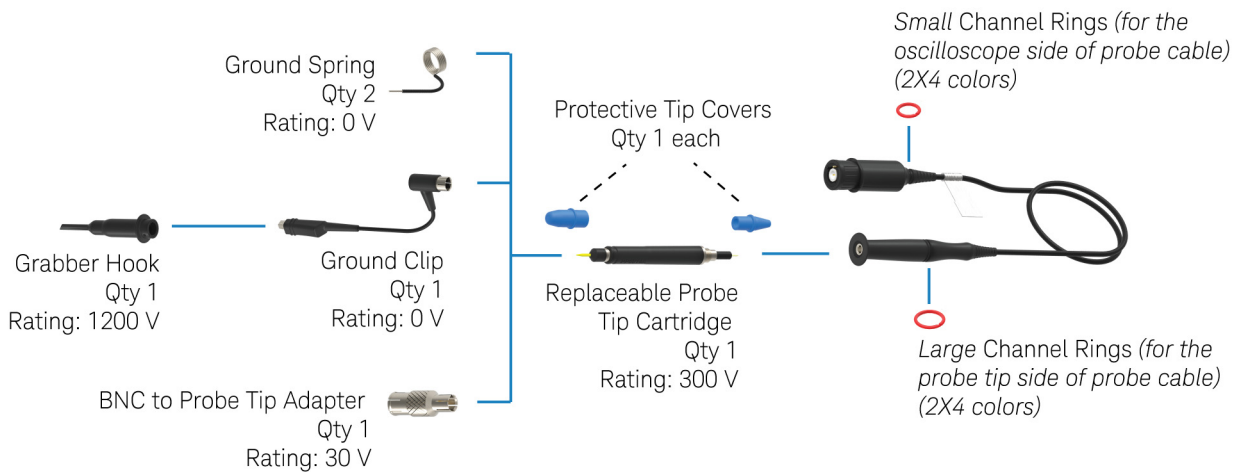

PP0002A Probe - Standard Accessories

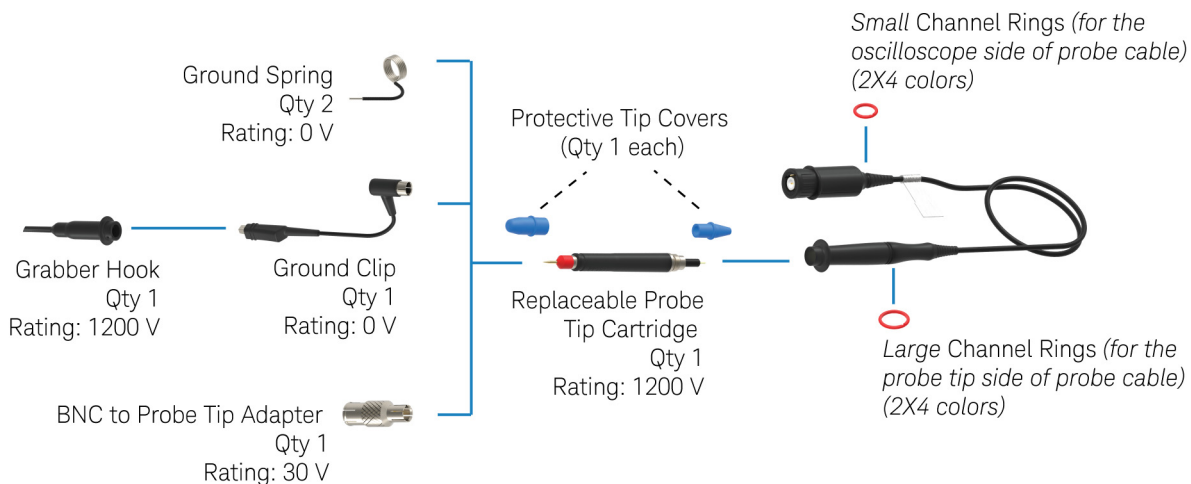

PP0003A Probe - Standard Accessories

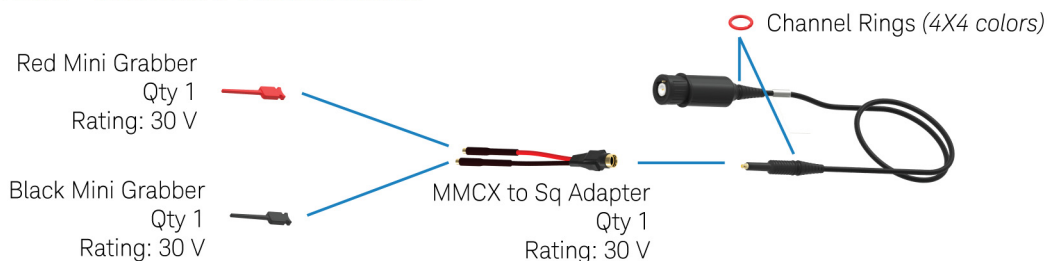

Orderable Accessories

Besides the standard accessories that are shipped with these probes, replacement and additional accessories are also available that you can order separately as the following accessory kits.

PP0011A Accessory Kit

(For use with PP0001A and PP0002A probes only)

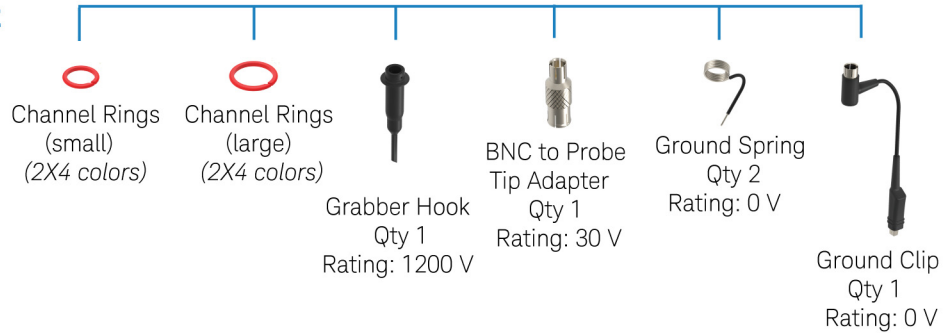

PP0013A Accessory Kit

(For use with PP0003A probe only)

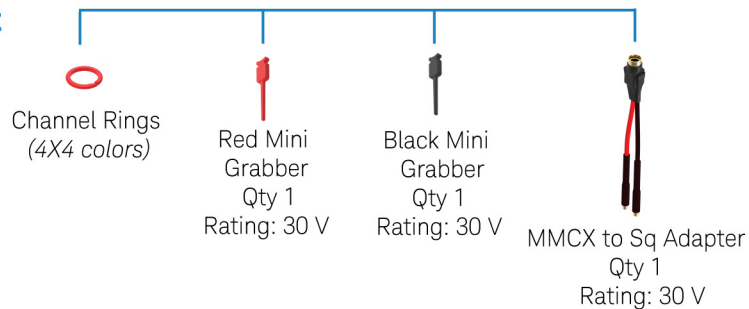

PP0014A Fixed Cartridge Accessory Kit

(For use with PP0001A probe only)

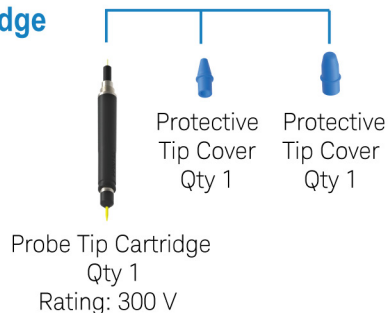

PP0017A Adapter Kit

(For use with PP0001A probe only)

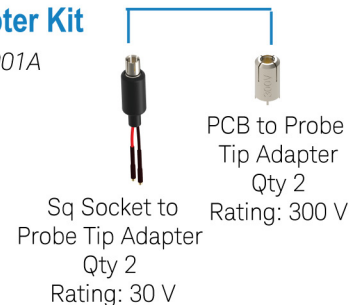

PP0018A Fixed Cartridge Accessory Kit

(For use with PP0002A probe only)

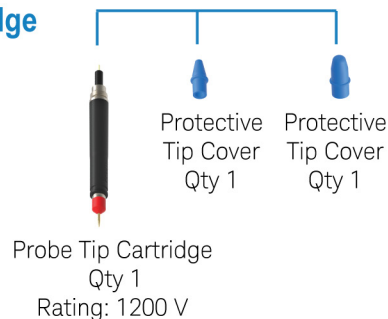

PP0019A Adapter Kit

(For use with PP0002A probe only)

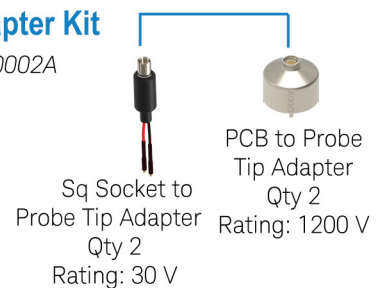

2 Characteristics and Specifications

Electrical Characteristics	12
Environmental Characteristics	13
Mechanical Characteristics	14
Accessories Dimensions	14
PCB Adapters Footprints and Solder Layouts	15

The tables in this chapter list the characteristics for the PP0001A/2A/3A probes and their supported accessories.

NOTE

All entries included in this chapter are characteristics unless otherwise noted. These are the typical performance values of the PP0001A/2A/3A probes with supplied/orderable accessories.

Electrical Characteristics

These electrical characteristics values are applicable when the PP0001A/2A/3A probes are used in conjunction with the PP0004A adapter.

Characteristic	PP0001A	PP0002A	PP0003A
Bandwidth (-3 dB)	1 GHz	800 MHz	1 GHz
Rise Time (10%-90%)	400 psec	500 psec	400 psec
Max Input Voltage 	300 Vrms	1200 Vrms	30 Vrms
Transient Voltage (1.2 x 50 us impulse) ^a	1500 Vpk	3000 Vpk	42.4 Vpk
Overvoltage and Measurement Category per IEC -61010-031		CAT OTHER (Mains isolated) ^b	
Input Resistance @DC Capacitance	10 MΩ 4.0 pF	40 MΩ 2.0 pF	10 MΩ 4.0 pF
Derating Bandwidth Point	3 MHz	2 MHz	30 MHz
Propagation Delay (probe only)		~6.4 nsec	
Voltage Ratings of Supplied and Orderable Accessories		See page 9 and page 10	
Safety Conformance to		IEC/EN61010-031:2015 UL 61010-031 Edition 2 CAN/CSA-C22.2 No.61010-031:17	

a Short duration overvoltage of a few msec or less

b Mains isolated is for measurements performed on circuits not directly connected to a mains supply.

NOTE

In a classic high impedance passive probe, the attenuation factor allows you to calculate the max input by multiplying the oscilloscope's available sensitivity settings by the attenuation factor.

The PP0001A/2A/3A probes are a new generation of Hi-Z+ probes for which the probe is to be viewed as a combination of the "probe and probe adapter (PP0004A)". This combination does not have a fixed attenuation ratio but rather has multiple available attenuation ratios per given V/div settings to accommodate a very large dynamic range and flat frequency response. That's why, the attenuation ratio values are not included in the above table.

Environmental Characteristics

(For probe only)

Environmental Condition	Operating	Non-Operating
Temperature	-15 °C to +65 °C	-65 °C to +70 °C
Humidity	5% to 90% RH	5% to 90% RH
Altitude	3,000 m (9,842 feet)	15,300 m (50,196 feet)
Pollution Degree	2 ^a (rated for indoor use only)	

a Normally only non-conductive pollution occurs. Occasionally, however, a temporary conductivity caused by condensation must be expected.

Mechanical Characteristics

Characteristic	PP0001A	PP0002A	PP0003A
Probe Cable Length		1.3 m	
Ground Barrel Diameter	5 mm	5 mm	Not applicable

Accessories Dimensions

Dimensions for standard and orderable additional accessories are displayed below. All dimensions are in millimeters.

Grabber Hook

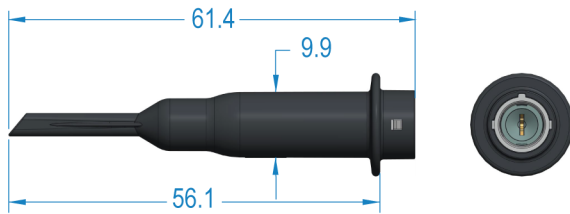

300 V PCB Adapter

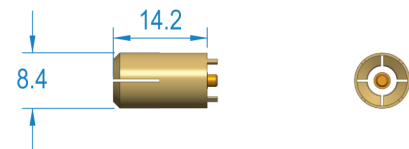

BNC Adapter

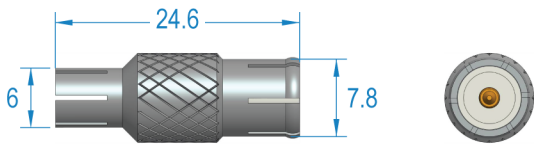

1200 V PCB Adapter

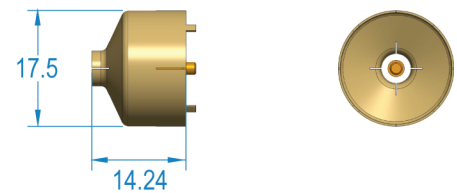

Insulated Ground Spring

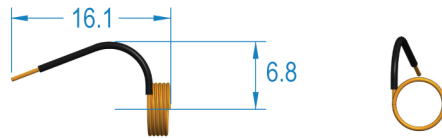

Sq Socket Adapter

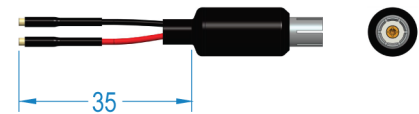

Ground Clip

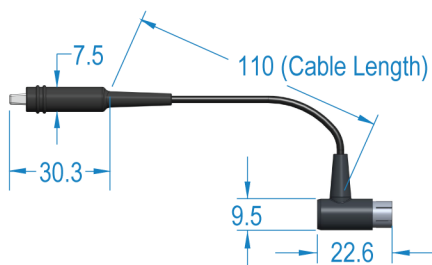

MMCX to Sq Adapter

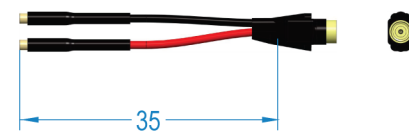

Mini Grabber

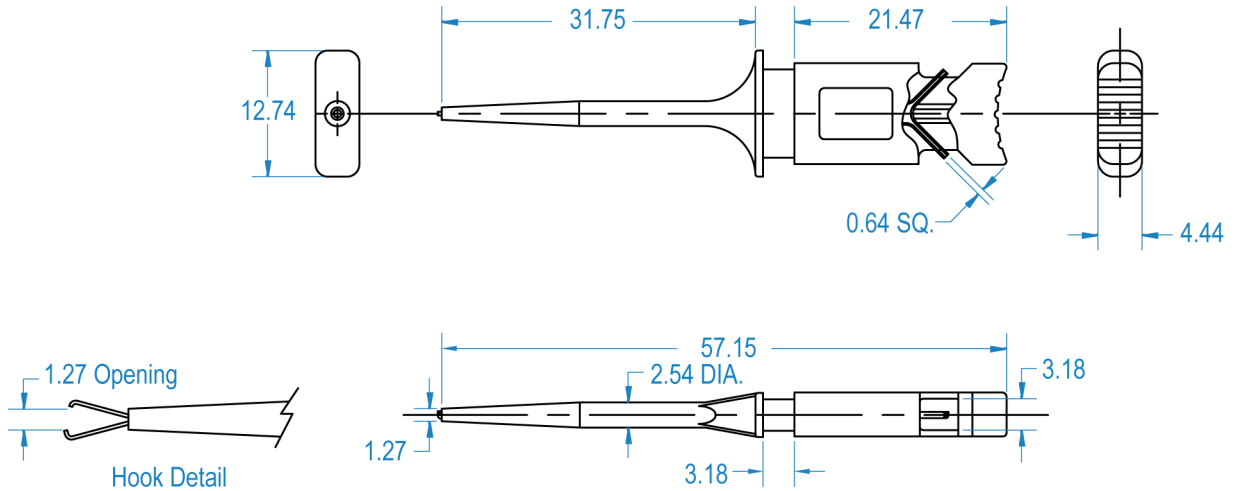

PCB Adapters Footprints and Solder Layouts

NOTE

The 300 V and 1200 V PCB adapters are for use with the PP0001A and PP0002A probes respectively. These are not provided as standard accessories with these probes but are available as separately orderable accessories. Order the *PP0017A Adapter Kit* for PP0001A probe and the *PP0019A Adapter Kit* for PP0002A probe.

300 V PCB Adapter

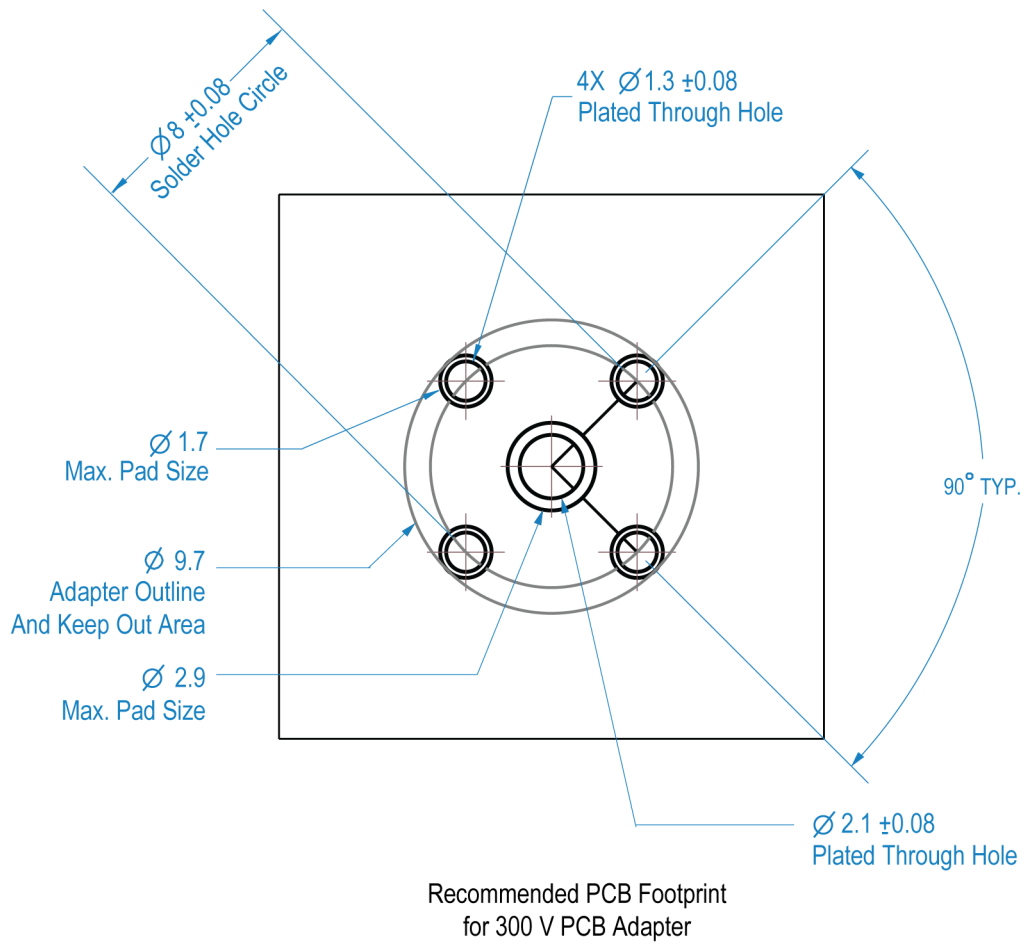
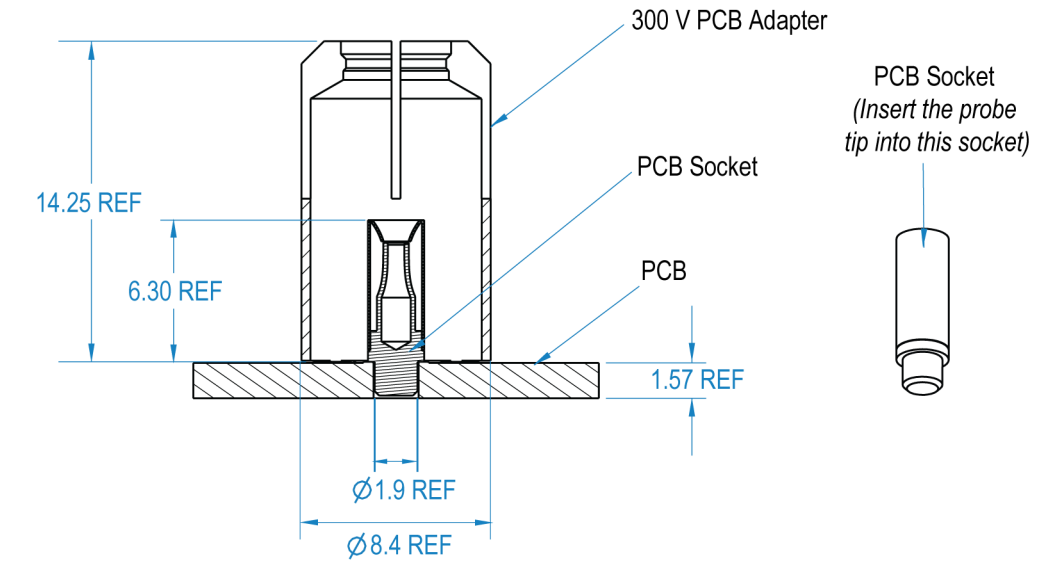

1200 V PCB Adapter

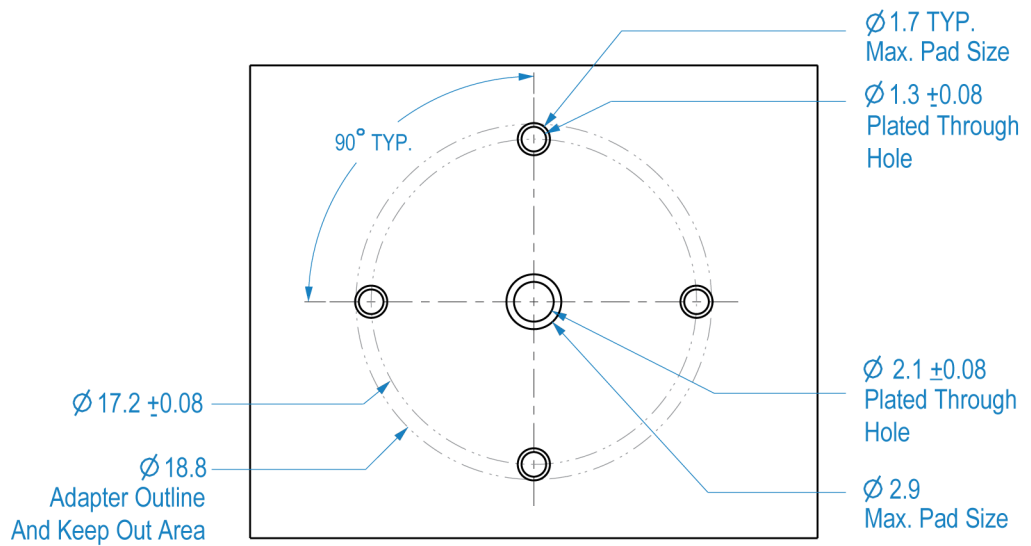
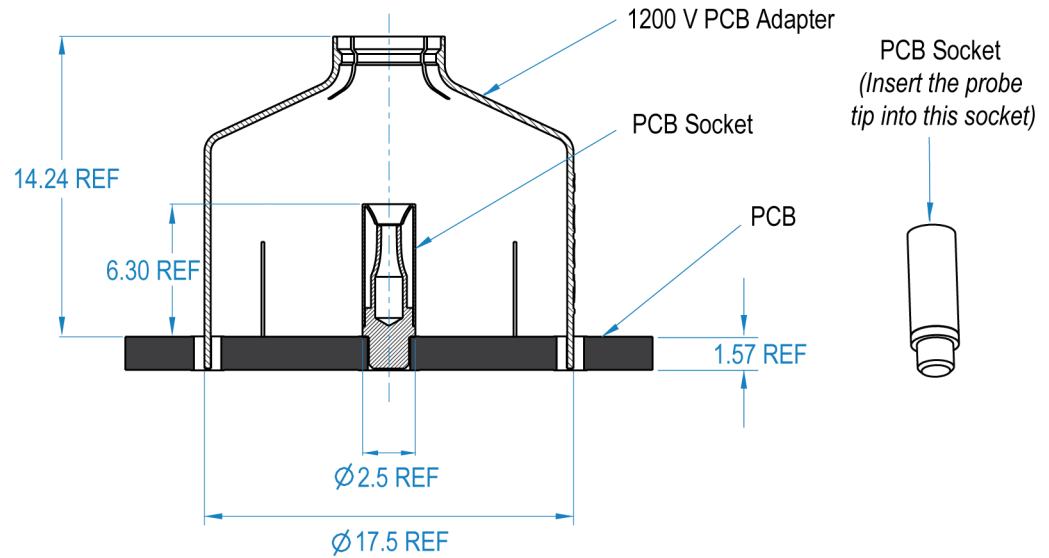

Recommended PCB Footprint
for 1200 V PCB Adapter

2 Characteristics and Specifications

3 Setting up and Using PP0001A/2A/3A Probes

Adjusting the Probe for Frequency Compensation	20
Connecting the Probe to an Oscilloscope	22
Making DUT Connections using Probe Accessories	23
DUT Connectivity Options for PP0001A and PP00002A Probes	24
DUT Connectivity Options for PP0003A Probe	29

Adjusting the Probe for Frequency Compensation

NOTE

You should adjust the PP0001A/2A/3A probes for frequency compensation before you make a measurement with the probe for the first time.

Compensation is an adjustment process that increases the accuracy of your measurements. A poorly compensated probe clearly influences the overall system performance (probe and oscilloscope) and introduces measurement errors resulting in inaccurate readings and distorted waveforms.

To perform frequency compensation

- 1 Connect the PP0004A adapter to an input channel of the oscilloscope and then connect the probe to this adapter.
- 2 Connect the probe's signal and ground to the **Probe Compensation** and **Ground** lugs on the PP0004A adapter.
Use appropriate accessories supplied with the probe to make these connections. For instance, you can use the Grabber Hook and Ground Clip supplied with the PP0001A and PP0002A probes to connect the probe's signal and ground respectively to the adapter.

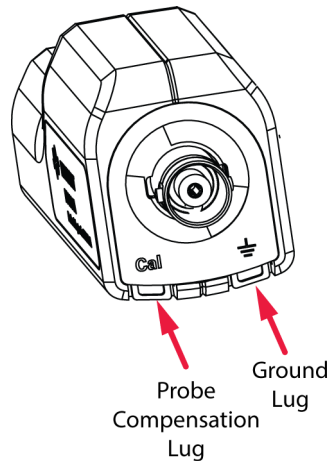
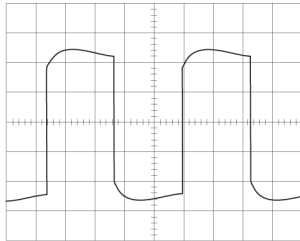

Figure 1 PP0004A Adapter Lugs

- 3 Perform compensation using the oscilloscope software until you see the optimally compensated square waveform.

The following images show examples of undercompensated waveform, overcompensated waveform, and optimum waveform.



Undercompensated

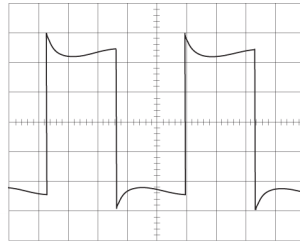

Overcompensated

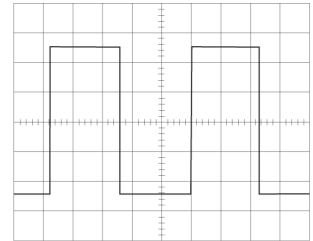

Optimum

Connecting the Probe to an Oscilloscope

- 1 Connect the PP0004A adapter to an input channel of a compatible Keysight oscilloscope by gently pushing the adapter onto the connector on the oscilloscope's input channel. As the adapter is pushed, the lever on top of the adapter moves to the left. When the adapter is fully seated, the lever returns to the locked position.
- 2 Connect the probe to the BNC connector on the PP0004A adapter.

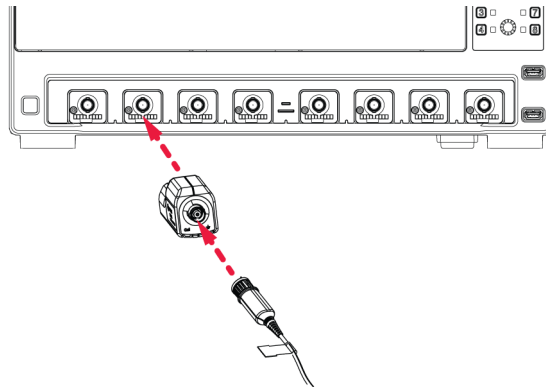
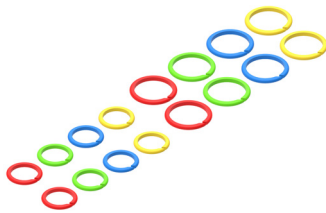

Figure 2 PP0001A probe connected to the PP0004A adapter and MXR-series oscilloscope

Using Channel Identification Rings



When multiple probes are connected to the oscilloscope, you can quickly identify which probe is connected to each oscilloscope channel by using the supplied channel identification rings.

Place rings of the same color on each end of the probe's cable. For the PP0001A and PP0002A probes, place the smaller ring on the oscilloscope side of the probe cable and the larger ring on the probe tip side of the probe cable.

Using these rings ensures that you can pick up a probe and immediately know which channel it is connected to without having to track the cable back to the oscilloscope channel input.

NOTE

These probes can accommodate two rings on each end of the probe cable. This allows you to create color combinations with two rings of different colors on each end of the probe cable. This is particularly useful when you are using more than four channels of an oscilloscope.

Making DUT Connections using Probe Accessories

Once the probe is connected to the oscilloscope, you can connect it to the DUT using appropriate probe accessories that suit your specific probing and DUT connectivity requirements.

This section provides information on the recommended DUT connectivity options available for each of these probes using their supplied and orderable accessories.

CAUTION

The accessories are unique to the probe model with which these are supplied. These cannot be used interchangeably with other probe models.

WARNING

The ground connection is critical to the safe operation of the probe. Failure to make the ground connection when making high voltage measurements may result in personal injury or damage to the probe or oscilloscope. This connection must always be made BEFORE the probe tip/probe accessory comes in contact with the high voltage and must NOT be removed until the probe tip/probe accessory has been removed from the high voltage source.

NOTE

Prior to probing, ensure that the probe tip cartridge is fully seated on the probe handle.

DUT Connectivity Options for PP0001A and PP00002A Probes

Browsing with Ground Connected

Accessories Used - Ground Spring and Probe Tip Cartridge

The ground spring offers great flexibility when making a ground connection. It is mainly used for browsing as it is flexible and snaps back to original orientation which allows you to connect it to your grounding location and then conveniently move the probe tip around.

The ground spring improves measurement performance by providing a short ground connection. The shorter lead reduces the inductance in the ground return path which corresponds to higher performance than using the ground clip.

1 Attach the ground spring to the probe.

- a Insert the ground spring over the probe tip as shown in the following figure. The spring must make contact with the metallic band on the probe's tip.

2 Connect the ground spring to the grounding location and then make a contact between the probe tip and probing location.

WARNING When the ground spring accessory is in use with the probe, the spacing between the ground spring tip and probe tip must be a minimum of: **1.5 mm** for PP0001A probe and **6.05 mm** for PP0002A probe.

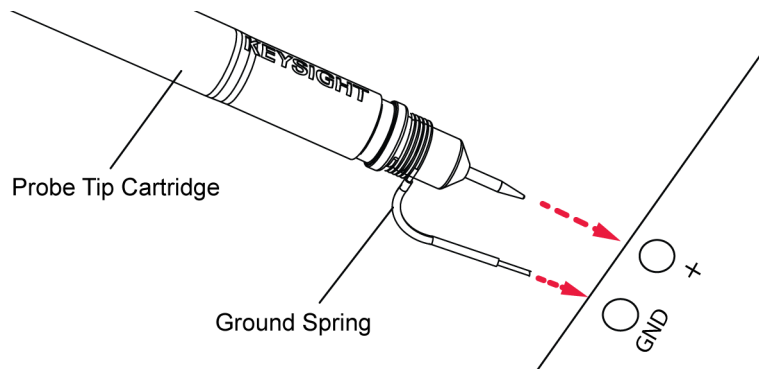

See [page 14](#) for Ground Spring dimensions.

WARNING

The ground spring is only rated for connection to earth ground (0V) and may only be used when measuring signals ≤ 30 Vrms.

Connecting to a Test Point with Ground Connected

Accessories Used - Ground Clip, Grabber Hook, and Probe Tip Cartridge

In this scenario, you can use:

- the grabber hook to connect to the probing test point.
- the ground clip to connect to the grounding location.

The advantage of using ground clip is that it allows you to reach grounding locations that are farther away from the probing location than can be reached by the ground spring. However, the longer lead results in a larger inductance in the ground return path when compared to the ground spring which corresponds to a slightly lower performance than the ground spring.

1 Attach the ground clip to the probe.

- Connect the probe tip cartridge to the probe handle.
- Insert the ground clip over the probe tip and continue pushing it over the probe tip cartridge until it reaches the probe barrel.
- Gently push to insert the ground clip into the probe barrel.

2 Attach the grabber hook to the probe.

NOTE Firmly push the grabber hook onto the probe tip until you hear a “click” sound. If you do not push the grabber hook completely so it can fully engage and “lock on” to the probe tip, the accessory may fall off or suffer a decrease in performance.

3 Connect the ground clip to the grounding location and then clamp the grabber hook to the probing test point.

WARNING The ground clip is only rated for connection to earth ground (0V).

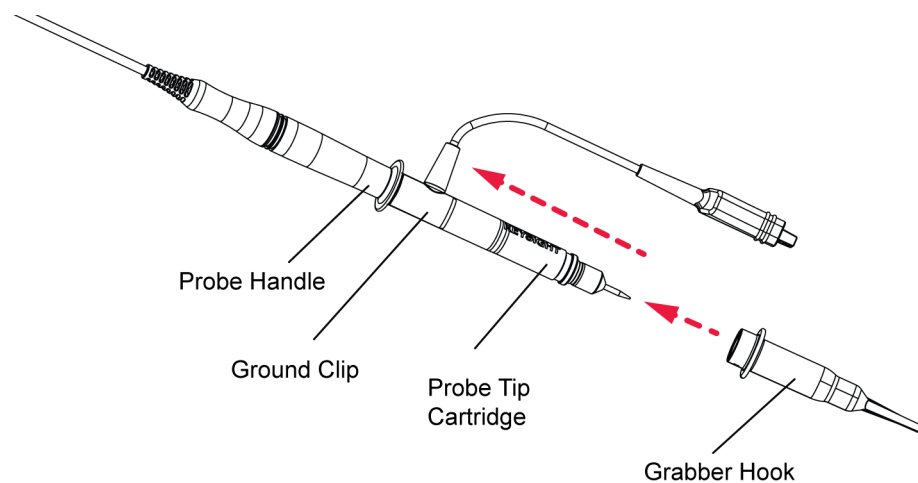

See [page 14](#) for Ground Clip and Grabber Hook dimensions.

Connecting to a BNC (f) Connector on Test Board

Accessories Used - BNC to Probe Tip Adapter and Probe Tip Cartridge

The BNC adapter connects the PP0001A/2A probes to a BNC (female) connector on the test board.

- 1 Attach the BNC adapter to BNC connector on test board.**
- 2 Insert the probe tip into the BNC adapter.**

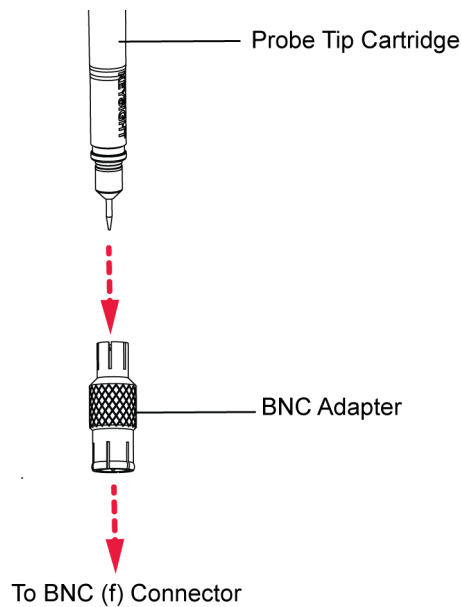

See [page 14](#) for BNC Adapter dimensions.

Connecting to Square Pin Connectors on Test Board

Accessories Used - Sq Socket to Probe Tip Adapter and Probe Tip Cartridge

The Sq Socket to Probe Tip Adapter offers a convenient and reliable method to connect both the probe signal and ground to probe points on the test board. The sockets of this adapter accept 0.64 mm (0.025 inch) square pins.

- 1 **Connect the Sq socket adapter to the square pin connectors on board.**
- 2 **Insert the probe tip into the Sq socket adapter.**

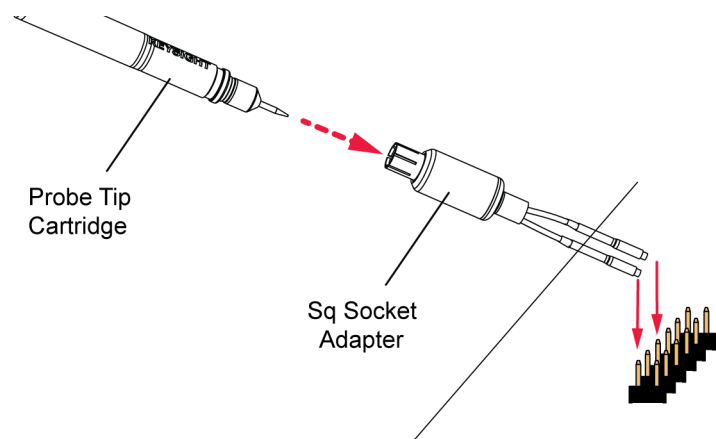

See [page 14](#) for Sq Socket Adapter dimensions.

Connecting Directly to a PCB

Accessories Used

- Probe Tip Cartridge
- 300 V PCB to Probe Tip Adapter (for PP0001A probe)
- 1200 V PCB to Probe Tip Adapter (for PP0002A probe)

The PCB Adapter sockets are designed to solder into a printed circuit board (PCB) as test points to minimize ground inductance and maximize signal fidelity. These PCB adapters provide a robust connection to signals in tight spaces.

The PCB socket is compatible with hand soldering and reflow processes.

- 1 Solder the PCB socket (signal contact and ground contact) to the PCB.**
See [page 15](#) and [page 17](#) for the recommended PCB footprints and solder layouts for these PCB adapters.
- 2 Insert the probe tip into the soldered PCB socket on the board.**

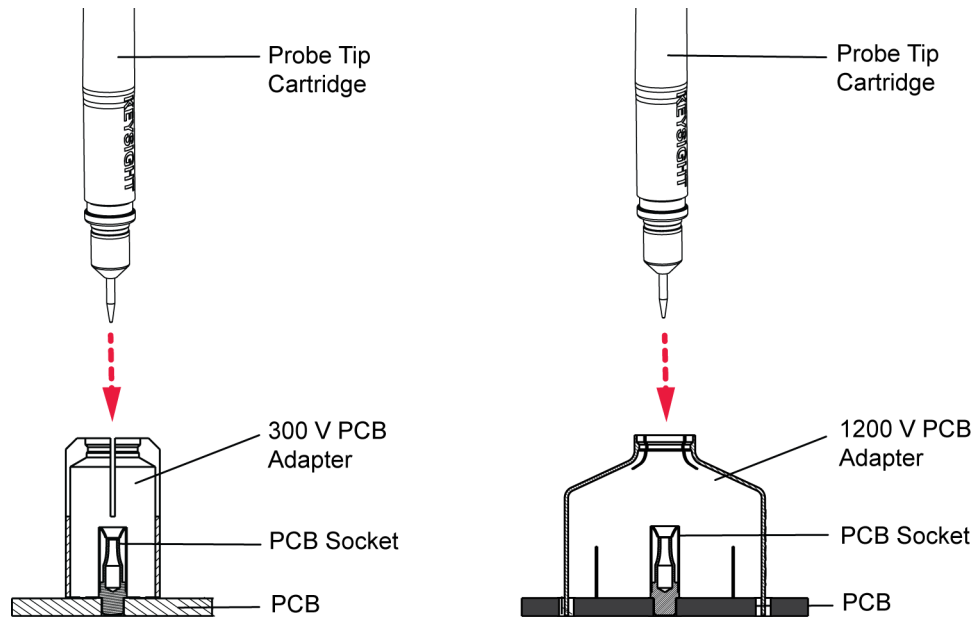

See [page 14](#) for PCB Adapter dimensions.

DUT Connectivity Options for PP0003A Probe

Option 1 - Connecting Directly to an MMCX Connector on Test Board

The PP0003A probe tip supports direct connection to MMCX connector on test board.

Option 2 - Connecting to Square Pin Connectors on Test Board

If your test board has square pin connectors, you can use the MMCX to Sq Adapter supplied with the probe. Using this adapter, you can connect both the probe signal and ground to probe points on the test board. The sockets of this adapter accept 0.64 mm (0.025 inch) square pins.

- 1 **Connect the MMCX to Sq adapter to the square pin connectors on board.**
- 2 **Insert the PP0003A probe tip into the MMCX to Sq adapter.**

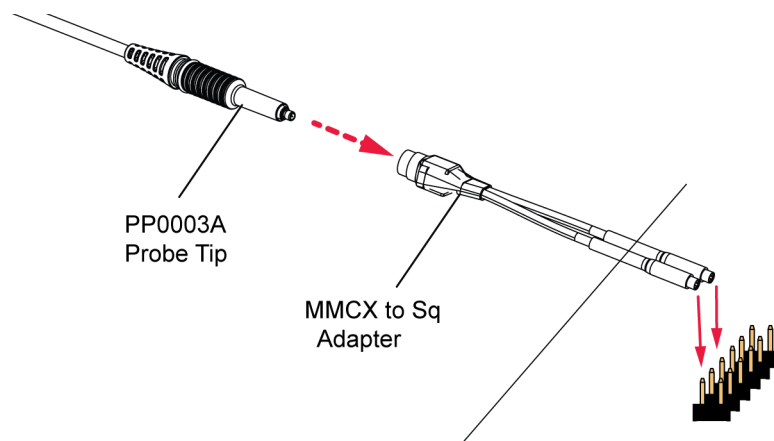

See [page 14](#) for MMCX to Sq Adapter dimensions.

Option 3 - Connecting to Miniature IC and Components on Test Board

Use the red and black mini grabbers along with the MMCX to Sq adapter supplied with the PP0003A probe.

- 1 **Press the mini grabbers onto the MMCX to Sq Adapter's leads. Connect the red mini grabber to the red lead of the adapter and black mini grabber to the black lead of the adapter.**
- 2 **Push the back of the mini grabbers to extend their pincers.**
- 3 **Extend the pincers around the circuit component to be probed. These pincers can open and grab onto conductors up to 1.27 mm.**

See [page 14](#) for Mini Grabbers dimensions.

3 Setting up and Using PP0001A/2A/3A Probes

4 Safety and Regulatory Information

Safety Checks and Warnings	32
Instrument Markings and Symbols	34
Cleaning the Probe	35

Safety Checks and Warnings

These products have been designed and tested in accordance with accepted industry standards, and have been supplied in a safe condition. The documentation contains information and warnings that must be followed by the user to ensure safe operation and to maintain these products in a safe condition.

WARNING

If the probe assembly is used in a manner not specified by the manufacturer, the protection provided by it may be impaired.

WARNING



These probes are for use only on circuits that are NOT directly connected to mains. These are NOT intended for measurements on CAT II, CAT III, or CAT IV circuits.

For accessories listed in this guide, the probe assembly-accessory combination is rated for measurements on mains isolated circuits only, not CAT II, III, or IV circuits.

WARNING



Be careful when applying high voltage to the inputs of PP0001A/ 2A probes. Follow all pertinent safety rules and guidelines for elevated voltage measurements. Only qualified personnel should perform any testing with voltage levels exceeding 30 Vrms.

WARNING

Do not apply any electrical potential to the probe input which exceeds the maximum rating of the probe. Make sure to comply with the voltage versus frequency derating curve on [page 38](#).

WARNING

Periodically inspect the probe wires and cables. When the insulation of the probe's cable deteriorates, the wear indicator becomes visible. Do not use the probe if the wear indicator is visible through the cable jacket. Using a product with a worn cable may result in electric shock, fire, or equipment failure.

If you suspect a damage, have it inspected by a Keysight authorized service personnel.

WARNING

Do not install substitute parts or perform any unauthorized modification to the probe / accessory.
Do not attempt internal service or adjustment. Service should be carried out by a Keysight Technologies authorized service personnel. For any service needs, contact Keysight Technologies. See [page 43](#) to know more.

WARNING

Handle probe tips/accessories carefully to avoid personal injury. Some of the probe tips/accessories are sharp.

CAUTION

Probe must be fully connected to the oscilloscope prior to connection to the device under test.
Probe must be disconnected from the device under test prior to disconnecting from the oscilloscope.
Use Only Grounded Instruments. Do not connect the probe's ground lead to a potential other than earth ground. Always make sure the probe and oscilloscope are grounded properly. Before making connections to the input of this probe, ensure that the probe's output connector is attached to the channel input of the oscilloscope via the PP0004A adapter and the oscilloscope is properly grounded.

WARNING

The ground clip and ground spring are only rated for connection to earth ground (0V).

WARNING

Indoor Use Only.
Do not operate in wet/damp environments. Keep product surfaces dry and clean.



WARNING

Do not operate the probe or oscilloscope in the presence of flammable gasses or fumes. Operation of any electrical instrument in such an environment constitutes a definite safety hazard.

CAUTION

Do not twist, tightly bend, or kink the probe cable to avoid degrading the probe's performance.

Instrument Markings and Symbols

Symbol	Description
	<p>This symbol indicates the Environmental Protection Use Period (EPUP) for the product's toxic substances for the China RoHS requirements.</p>
	<p>Notice for the European Community: This product complies with the WEEE Directive (2002/96/EC) marking requirements. The affixed label indicates that you must not discard this electrical/electronic product in domestic household waste.</p> <p>Product Category: With reference to the requirement types in the WEEE Directive Annex I, this product is classed as a "Monitoring and Control Instrumentation" product.</p> <p>Do not dispose in domestic household waste.</p> <p>To return unwanted products, contact your local Keysight office.</p>
	<p>The product is marked with this symbol when it is necessary for the user to refer to the instructions in the documentation.</p>

Cleaning the Probe

If the probe requires cleaning:

- 1** Disconnect the probe from the oscilloscope and device under test.
- 2** Wipe it with a soft cloth dampened with mild soap and water solution. Do not use too much liquid or any chemicals.
- 3** Make sure the probe is completely dry before reconnecting it to the oscilloscope.

4 Safety and Regulatory Information

5 Performance Plots

Derating Curve	38
Input Impedance	39

Derating Curve

The following figure shows the derating curve for PP0001A/2A/3A probes.

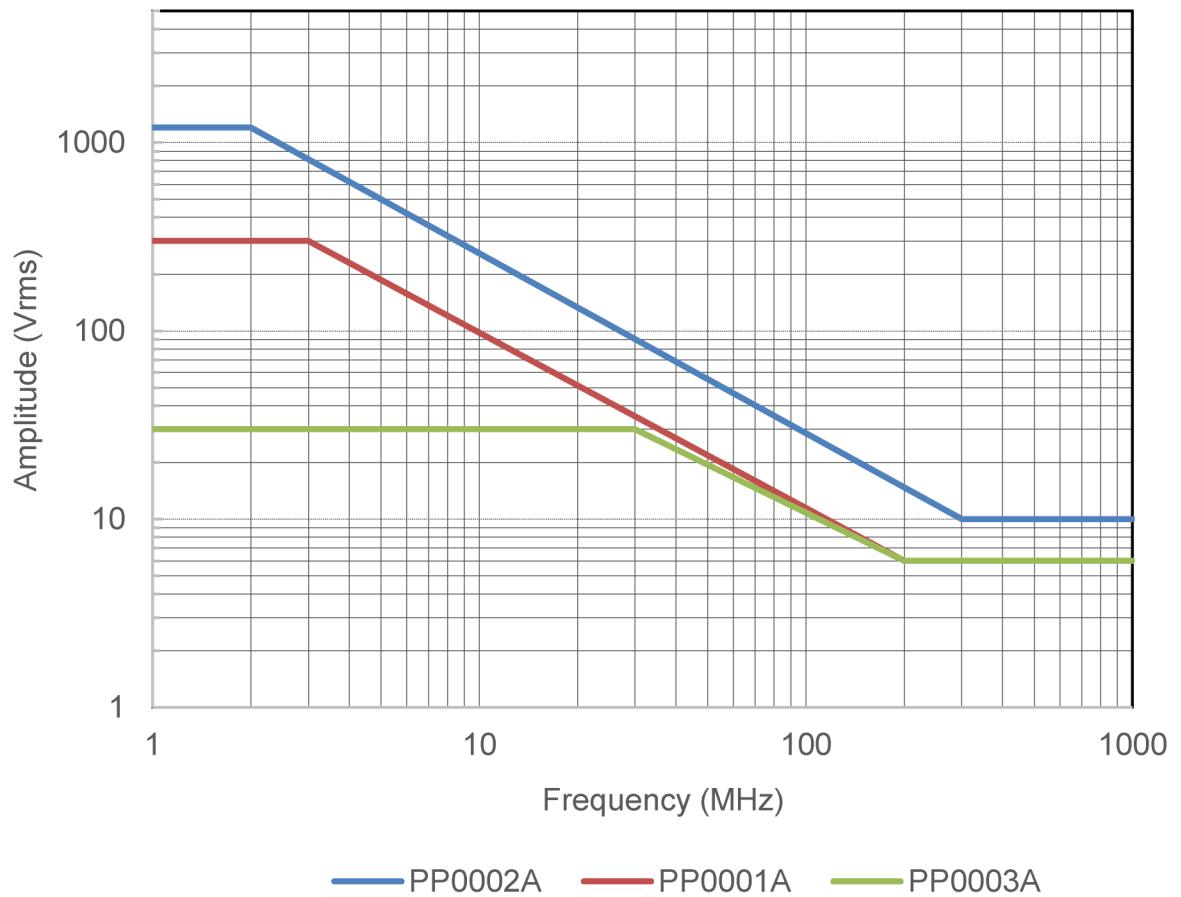

Input Impedance

This section includes the input impedance plots and SPICE Deck for PP0001A/2A/3A probes to show the matching of the measured data to the modeled data.

PP0001A Input Impedance

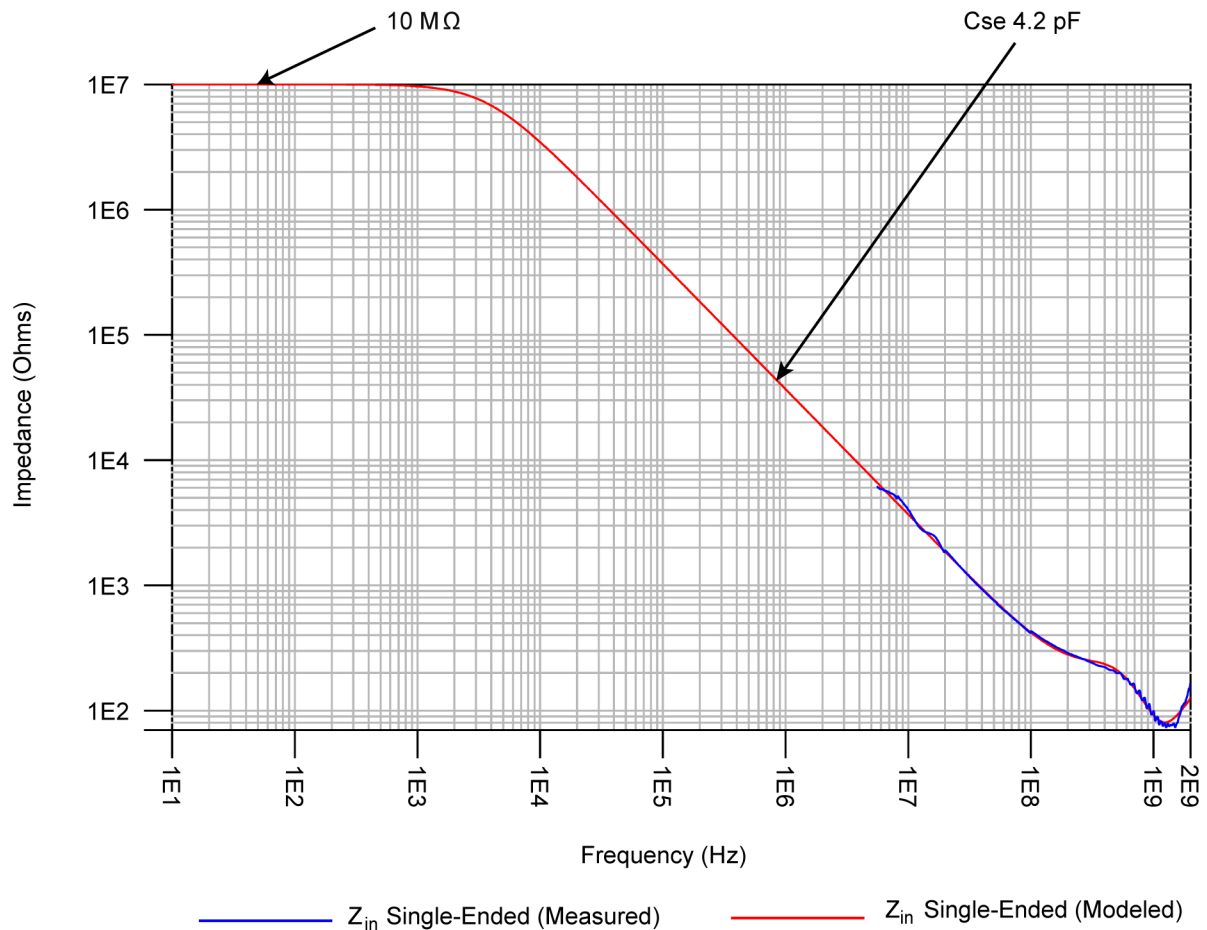

SPICE Deck for PP0001A

```
* Input impedance SPICE subckt for probe listed
.subckt PP0001A 1
r1 1 2 10.75
r2 2 0 10e6
r3 4 0 73.83
r4 6 0 356.9
c1 2 3 1.262p
c2 2 5 3.053p
l1 3 4 13.70n
l2 5 6 87.16n
ends
```

PP0002A Input Impedance

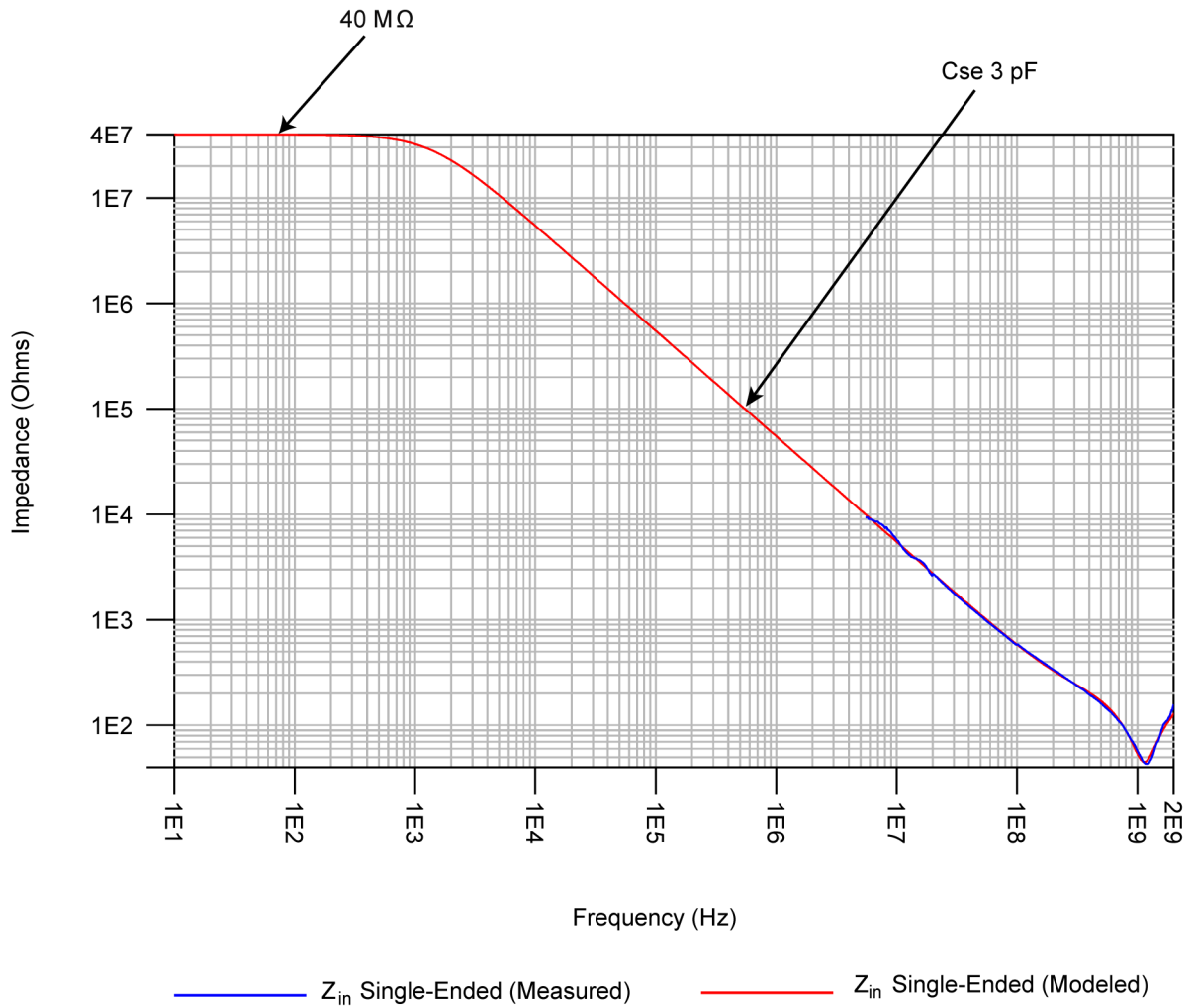

SPICE Deck for PP0002A

```
* Input impedance SPICE subckt for probe listed
.subckt PP0002A 1
r1 1 2 28.43
r2 2 0 40e6
r3 4 0 17.26
r4 6 0 370.8
c1 2 3 1.264p
c2 2 5 1.632p
l1 3 4 15.30n
l2 5 6 10.04n
ends
```

PP0003A Input Impedance

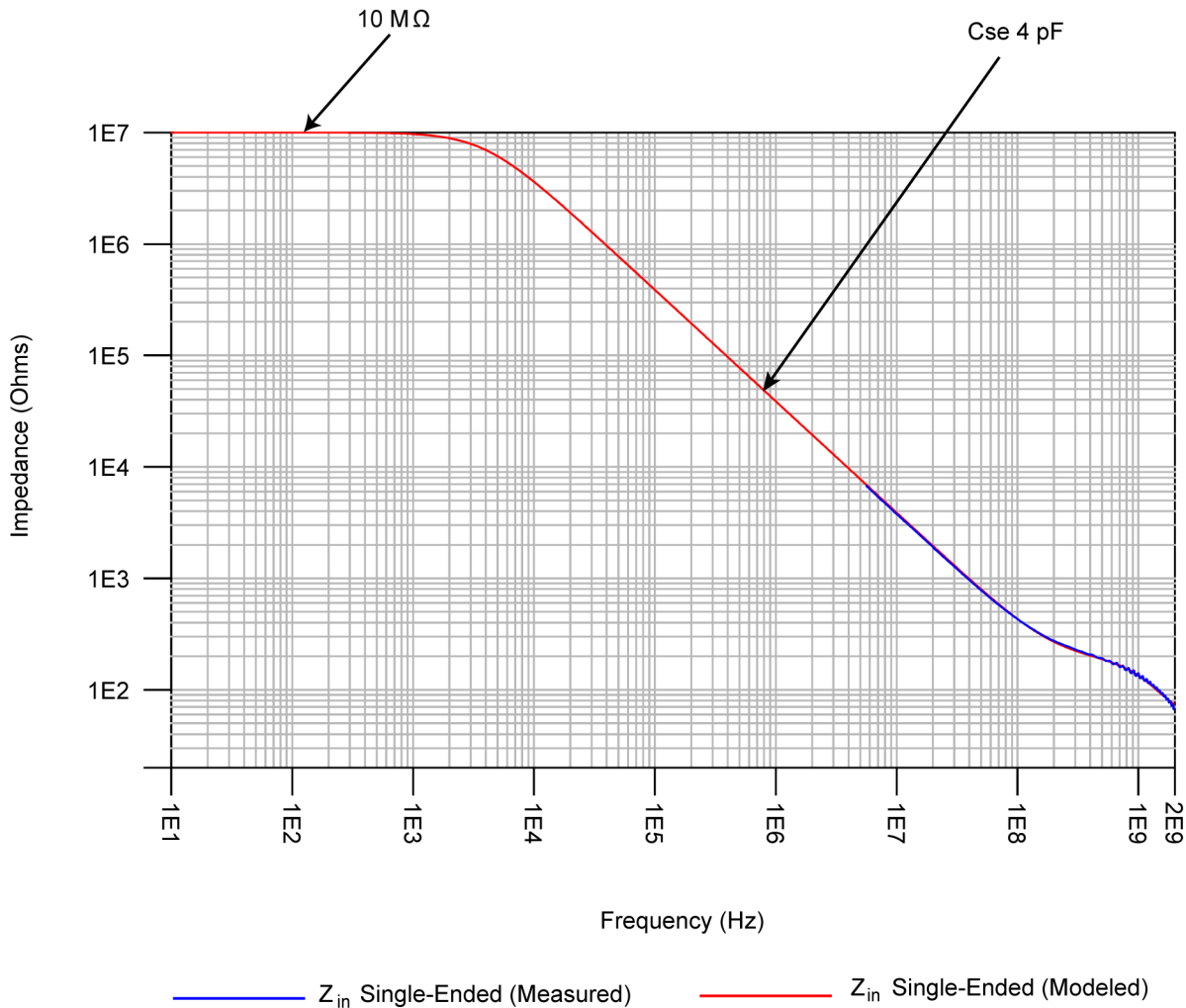

SPICE Deck for PP0003A

```
* Input impedance SPICE subckt for probe listed
.subckt PP0003A 1
r1 1 2 32.55
r2 2 0 10e6
r3 4 0 38.48
r4 6 0 250.2
c1 2 3 1.093p
c2 2 5 3.008p
l1 3 4 3.826n
l2 5 6 16.74n
ends
```

6 Returning the Probe for Repair/Service

WARNING

Do not install substitute parts or perform any unauthorized modification to the probe. Only Keysight service centers should perform repair/maintenance on the equipment.

Only Keysight approved accessories should be used.

NOTE

PP0001A/2A/3A passive probes

- 90-day standard warranty
 - No extended warranty
 - Not serialized
-

PP0004A adapter

- 1 year standard warranty
 - Full unit exchange
 - 3- or 5-year extended warranty (available as an option)
 - Serialized
-

Perform the following steps before shipping the probe back to Keysight Technologies for repair / service.

- 1 Contact your nearest Keysight sales office for any additional details.
- 2 Write the following information on a tag and attach it to the malfunctioning equipment.
 - Name and address of owner
 - Product model number (for example, PP0001A)
 - Product Serial Number (for example, MYXXXXXXXX)
 - Description of failure or service required

NOTE

Include accessories shipped with the probe.

- 3 Protect the probe by wrapping in plastic or heavy paper. Use original packaging or comparable.

4 Pack the probe in the original carrying case or if not available, use bubble wrap or packing peanuts.

5 Place securely in a sealed shipping container and mark container as "FRAGILE".

If any correspondence is required, refer to the product by serial number and model number.

Before returning an instrument for service, you must first call the Keysight Call Center.

Contacting Keysight Technologies for Technical Assistance

For technical assistance, contact your local Keysight Call Center.

- In the Americas, call 1 (800) 829-4444
- In other regions, visit <http://www.keysight.com/find/assist>

Index

A

accessories, 23
accessory kits, 10
adapter, 7, 8
adapter kit, 15
attenuation factor, 12

B

BNC adapter, 26

C

cleaning, 35

D

dimensions, 14

F

frequency compensation, 20

G

grabber hook, 25
ground clip, 25
ground connection, 24
ground spring, 24
ground spring tip spacing, 24
grounding location, 25

I

Infiniium oscilloscopes, 8
Infiniium software version, 8
input impedance, 39

M

mini grabbers, 29
MMCX, 6
MMCX connector, 29
MMCX to Sq Adapter, 29
MMCX to Sq adapter, 29

P

PCB, 28
PCB footprint, 16, 17
PP0004A, 6, 7, 12, 20, 22, 33
PP0017A, 15
PP0019A, 15

S

safety conformance, 12
safety information, 32
solder, 28
Sq socket adapter, 27

V

voltage rating, 12