

PicoScope® 4444

See the difference: high-resolution differential USB oscilloscope



Flexible 12- or 14-bit resolution
20 MHz bandwidth
Up to 400 MS/s sampling rate
256 MS capture memory

Four true differential inputs
High common-mode rejection ratio
Intelligent probe interface

Choice of accessories for multiple applications
Low-level electronic and biomedical signal analysis
Mobile and IoT device design
General electronic test and measurement
1000 V CAT III voltage and current measurement

The PicoScope 4444 with PicoConnect® probes: a new standard in differential measurement

With four true differential inputs, 12- to 14-bit resolution and wide differential and common-mode voltage ranges, the PicoScope 4444 and its accessories offer accurate and detailed measurement for a multitude of applications. The 9-pin D-type connectors provide a true differential probe interface, and also allow the PicoScope 6 software to automatically identify the probe and select the appropriate display settings.

1:1 differential probes

With most oscilloscopes, just connecting to the signal of interest can be very frustrating when one of the connection points has to be grounded. With the **PicoConnect® 441 1:1 differential voltage probe**, the PicoScope 4444 high-resolution differential oscilloscope allows you the freedom to connect to and visualize signals that are off-limits to a grounded-input oscilloscope. Connect directly to current-sensing resistors and differential signals, or across non-grounded components in a signal path.

The PicoConnect 441 probe does not attenuate your signal and is well suited to numerous electronics applications, as well as biomedical and other scientific research, as it allows high-speed high-resolution measurements on signals between ± 10 mV and ± 50 V in the presence of common-mode voltages and noise.

Supplied with detachable black and red sprung hook probe tips.

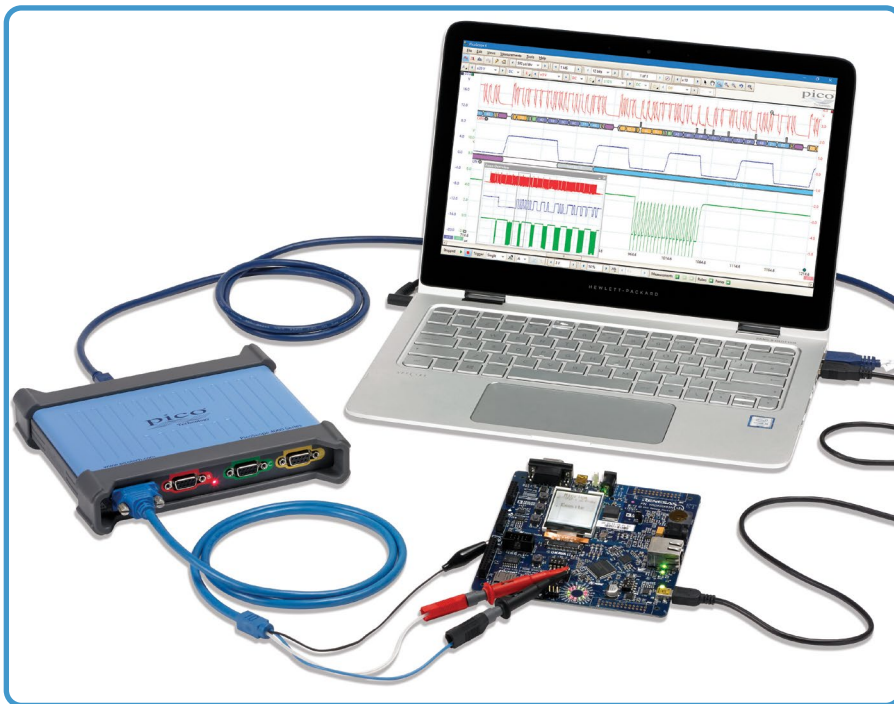

Embedded system design and test

1000 V CAT III differential probes

Testing and characterization of power supplies can present the oscilloscope user with many challenges, such as hazardous voltages (often floating without reference to ground), feedback circuitry with electrical isolation, and a wide range of signal levels. One wrong connection of a ground lead and sparks can fly! Using the **PicoConnect 442 1000 V CAT III differential voltage probe** with the PicoScope 4444, you can easily connect to and visualize the wide range of signals that need to be characterized.

The PicoConnect 442 probe has a 25:1 attenuation ratio and is suitable for testing in a range of applications, including distribution boards, circuit breakers, junction boxes, switches, fixed socket outlets and industrial equipment such as permanently connected stationary motors.

Supplied with detachable shrouded black and red sprung hook probe tips.

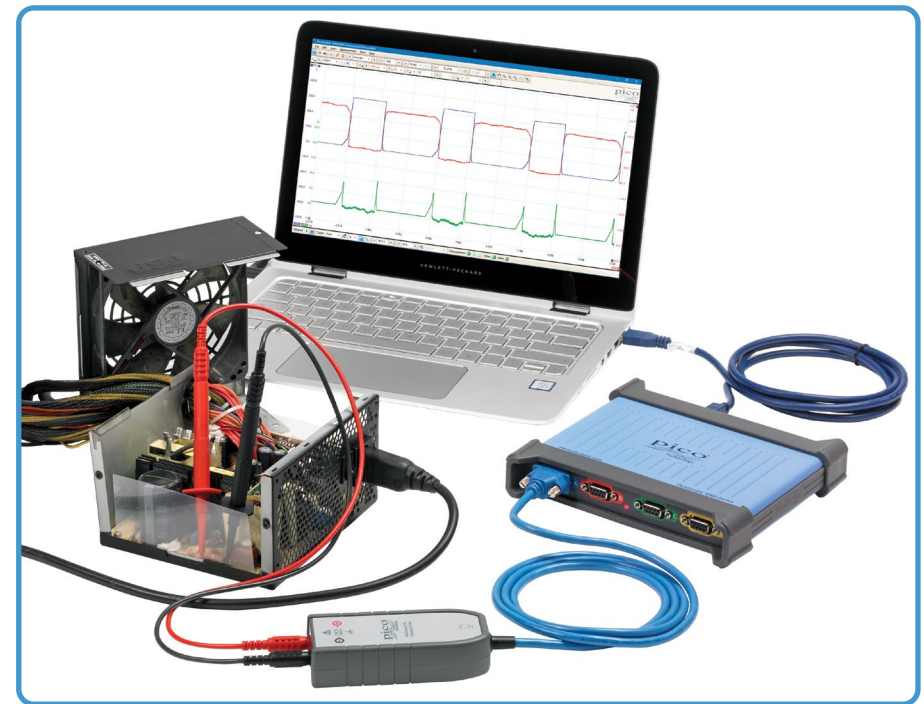

Power supply design and test

Why make differential measurements?

While you can make a wide variety of measurements with an ordinary ground-referenced scope, there are some circumstances where that just won't work.

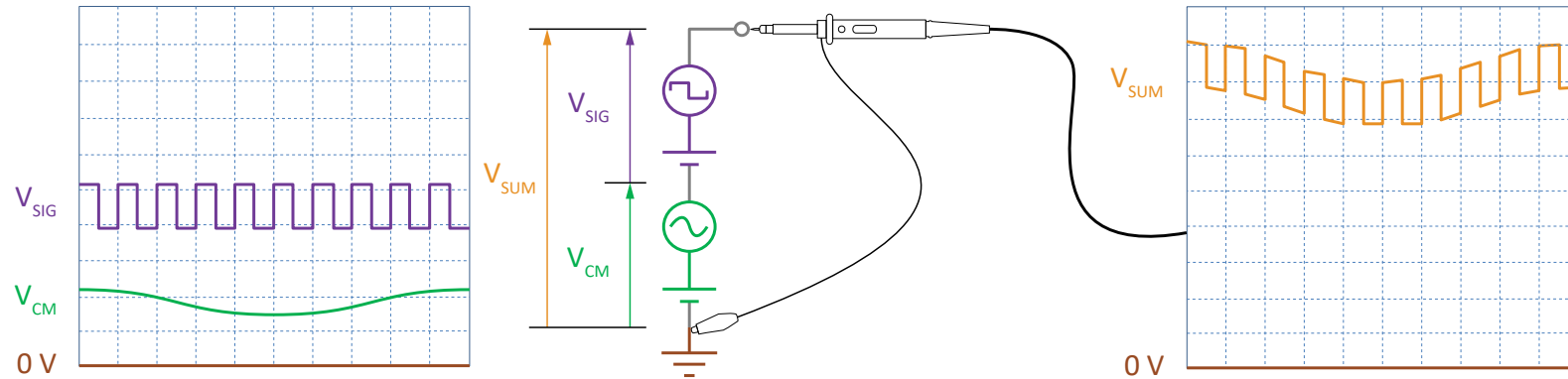

Common-mode voltages are unwanted signals that are applied equally to both measurement terminals in your probing system. The circuit above consists of a signal source (purple) with AC and DC components producing a total output of V_{SIG} , which we wish to measure. However, the circuit also contains an unwanted voltage source (green) that also has AC and DC components adding up to V_{CM} , a common-mode voltage. This situation is quite common, for example when probing high-side drivers in amplifiers and power supplies.

As the diagram above shows, probing this circuit with a single-ended scope results in a distorted waveform (V_{SUM}) on the display. We cannot simply connect the probe ground to the negative terminal of V_{SIG} , as that would short-circuit V_{CM} to ground through the oscilloscope, possibly causing a circuit malfunction or damage to the instrument. We need a measuring system that can safely detect V_{SIG} and ignore V_{CM} .

The solution, as shown below, is to connect a differential scope input across the positive and negative terminals of the signal source. The differential input does not measure V_{CM} , only V_{SIG} , so V_{SIG} is what you see on the oscilloscope display.

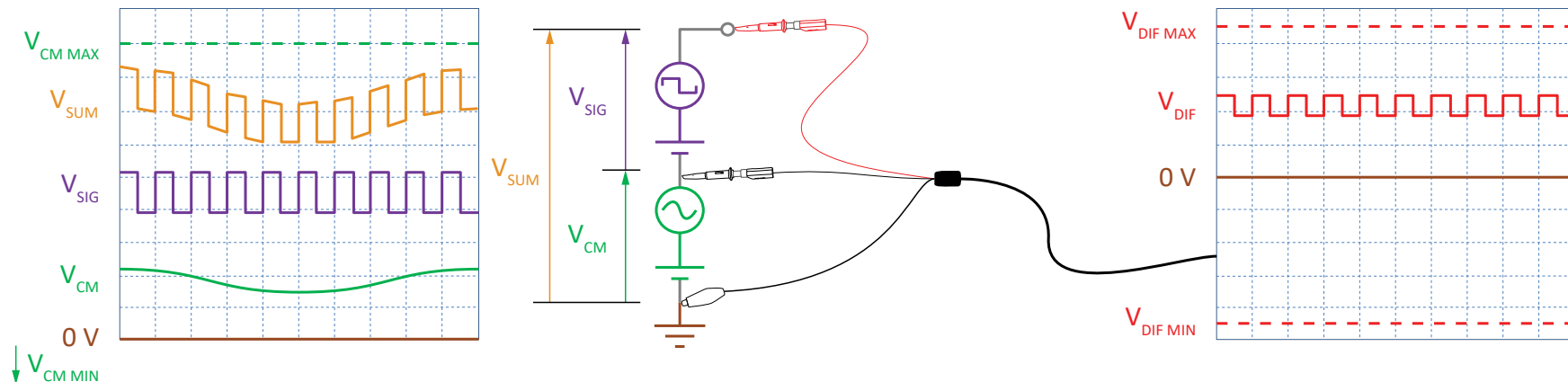

Differential scopes can measure the AC or DC voltage between two points connected to the positive and negative leads, when neither of the points is grounded. This enables them to take measurements where single-ended scopes can't, for example at voltages that are much higher than ground potential. The resulting measurements focus exclusively on the potential difference between the probes.

Why use the PicoScope 4444 differential oscilloscope?

There are, of course, plenty of differential probes available, all with similar inconveniences: bulky interface boxes, missing or flat batteries, snaking power leads... The PicoScope 4444 uses specially designed passive voltage probes that have smaller and lighter (or no) interface boxes. The PicoScope 4444 has high resolution and deep memory and lets you make multiple differential measurements at the same time, while never occupying more than one power socket. Its intelligent probe interface automatically configures the PicoScope display to your probes, so you don't have to.

True differential measurements in high resolution

The PicoScope 4444's four Pico D9 inputs allow you to make true differential measurements. The maximum input range at full scale is ± 50 V (± 1000 V using the PicoConnect 442 1000 V CAT III probe), and the maximum common-mode range is also ± 50 V (also ± 1000 V with the PicoConnect 442 probe). You can set the scope to measure at resolutions of 12 or 14 bits, far better than the 8-bit resolution typical of many oscilloscopes. The deep capture memory (up to 256 million samples shared by the active channels) is another advantage, allowing you to carry out long captures without lowering the sampling rate.

The two images below show a sine wave with a sawtooth interference pattern, displayed on an 8-bit PicoScope 2208B (left) and a PicoScope 4444 in 12-bit mode (right). The PicoScope 2208B has greater bandwidth and a faster sampling rate than the PicoScope 4444, but fails to resolve the fine detail of the signal. The 12-bit resolution of the PicoScope 4444 offers 16 times as much vertical detail, and its deeper capture memory of 256 MS gives it greater horizontal resolution, too.

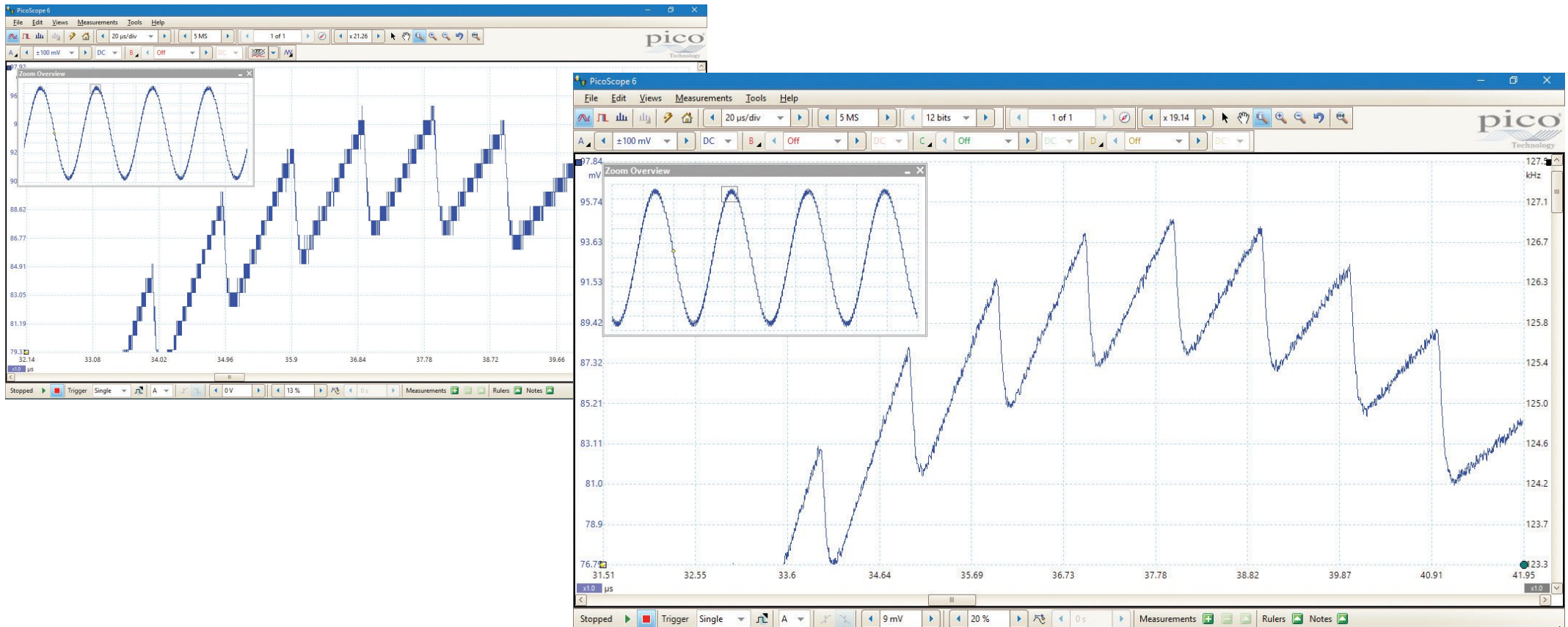

Deep memory

The PicoScope 4444 oscilloscope offers a large capture memory of 256 MS, allowing it to sustain high sampling rates across long timebases. Running at 12-bit resolution, it can sample at 400 MS/s all the way down to 50 ms/div giving a 500 ms total capture time.

Powerful tools are included to allow you to manage and examine all of this data. As well as functions such as mask limit testing and color persistence mode, the PicoScope 6 software enables you to zoom into your waveform by several million times. The Zoom Overview window allows you to easily control the size and location of the zoom area.

The image below shows how deep memory allows us to zoom in on an individual color burst in an NTSC signal, while preserving the detail of the signal.

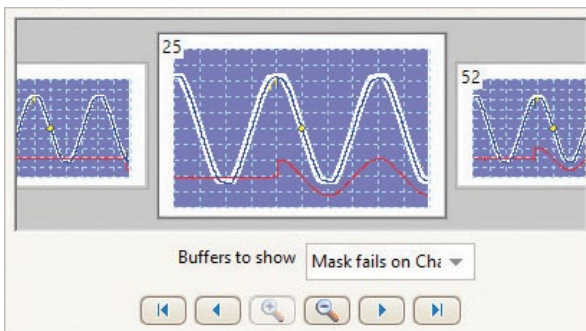
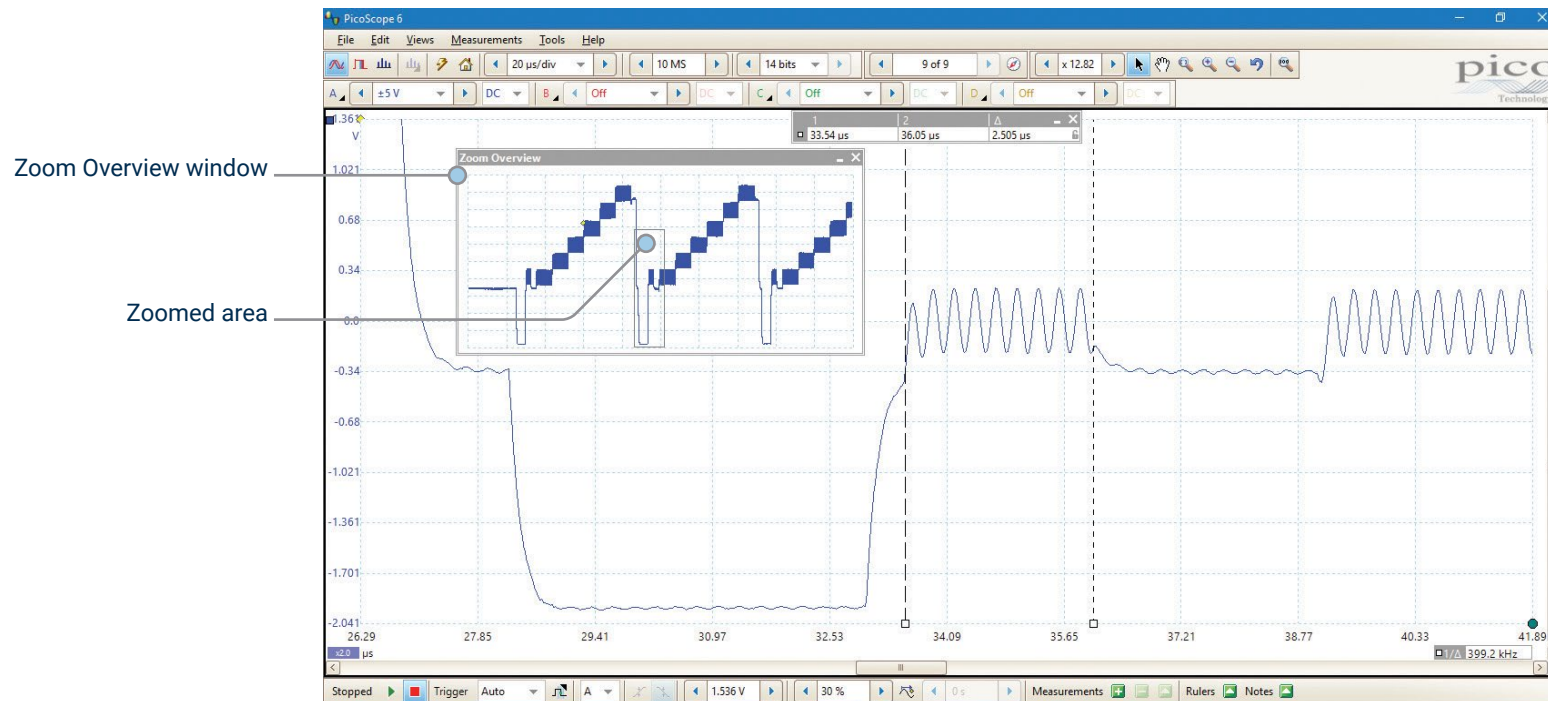

Up to 10 000 waveforms can be stored in the segmented waveform buffer. The Buffer Overview window then allows you to rewind and review the history of your waveform.

You can also use it to view mask limit test failures, making it far easier to spot infrequent glitches.

When the trace length is set to be shorter than the scope's memory, the PicoScope 4444 will automatically configure the memory as a circular buffer, recording recent waveforms for review. For example, if 1 million samples are captured, up to 250 waveforms will be stored in oscilloscope memory. Tools such as mask limit testing can then be used to scan through each waveform to identify anomalies.

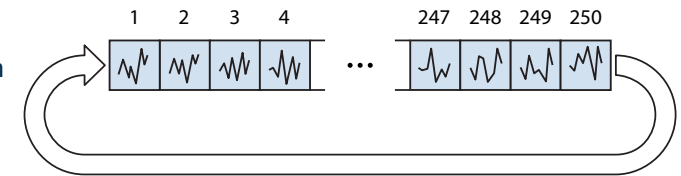

Unique intelligent probe interface

When you connect any Pico Technology probe with D9 connection to the PicoScope 4444, the PicoScope 6 software will detect, identify and, where necessary, power it. This means you spend less time setting up and don't have to worry about battery packs or power supplies. The software automatically sets up the display and controls to match your probe.

A notification appears in the bottom right corner of the PicoScope display whenever you connect or remove a probe.



Probe connected

Channel A - PicoConnect 441 1:1 probe



Probe removed

Channel A - PicoConnect 441 1:1 probe



Signal integrity

Careful front-end design and shielding reduces noise, crosstalk, and harmonic distortion. Years of oscilloscope design experience can be seen in improved bandwidth flatness, low distortion, and excellent pulse response. We are proud of the dynamic performance of our products, and publish their specifications in detail.

The result is simple: when you probe a circuit, you can trust in the waveform you see on the screen.

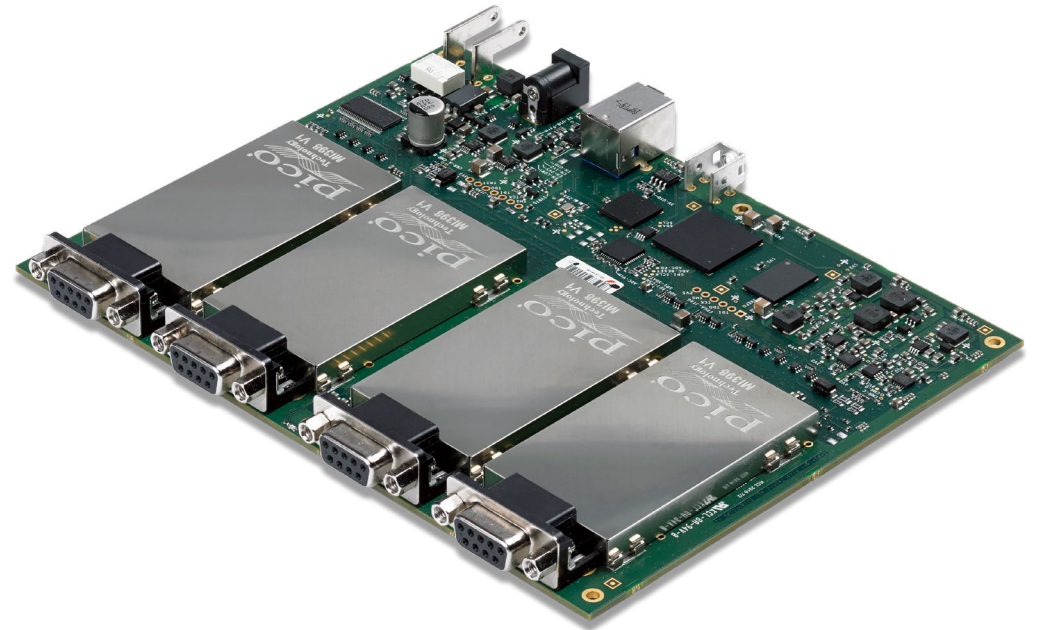

Excellent value and convenience

The PicoScope 4444 differential oscilloscopes and their accessories are highly cost-effective, compact and convenient, especially compared to combining a traditional single-ended oscilloscope with the same number of differential probes.

Oscilloscope kits

We and our distributors supply three preconfigured kits with everything you need to get started with differential measurement. Each kit includes a PicoScope 4444 high-resolution differential oscilloscope and three differential voltage probes with Pico D9 connectors. The kits also come with a TA271 D9-BNC adaptor, which lets you use traditional oscilloscope voltage probes and current probes, to make single-ended measurements with a ground-referenced probe. Finally, all three kits are delivered in a sturdy carry case, as shown below.

These and a range of other accessories are also available separately.

Extra low voltage differential kit



- PicoScope 4444 differential oscilloscope
- 3× PicoConnect 441 1:1 passive differential voltage probes
- 1× TA271 single-ended D9-BNC adaptor

The extra low voltage kit is ideal for use in non-ground-referenced measurements, including lower-amplitude, precision measurements in a wide range of applications. You can also use it to measure the signals on differential serial buses such as CAN and RS-485.

1000 V CAT III mains voltage kit



- PicoScope 4444 differential oscilloscope
- 3× PicoConnect 442 1000 V CAT III passive differential voltage probes
- 1× TA271 single-ended D9-BNC adaptor

The 1000 V CAT III mains voltage kit enables you to make non-ground-referenced measurements, safely probe single phase and 3-phase voltages and measure power drawn by mobile and IoT devices. It also has applications for hybrid and electric vehicle design, motor drives and inverters.

1000 V CAT III mains voltage and current kit



- PicoScope 4444 differential oscilloscope
- 3× PicoConnect 442 1000 V CAT III passive differential voltage probes
- 3× TA368 2000 A AC flex current probes (rated for 1000 V CAT III and 600 V CAT IV)
- 1× TA271 single-ended D9-BNC adaptor

Similar to the 1000 V CAT III mains voltage kit, but with three additional current probes, allowing safe measurement of currents up to 2000 A on uninsulated mains conductors.

Accessories

A number of accessories are available for the PicoScope 4444. These are available to purchase individually or in addition to a kit. Alternatively, you can design your own kit configuration on our website, www.picotech.com.

Remember: all accessories marked with the  symbol use Pico D9 connectors and our unique intelligent probe interface, so can only be used with the PicoScope 4444.

Differential voltage probes

PicoConnect 441 probe: measure from millivolts to ± 50 V

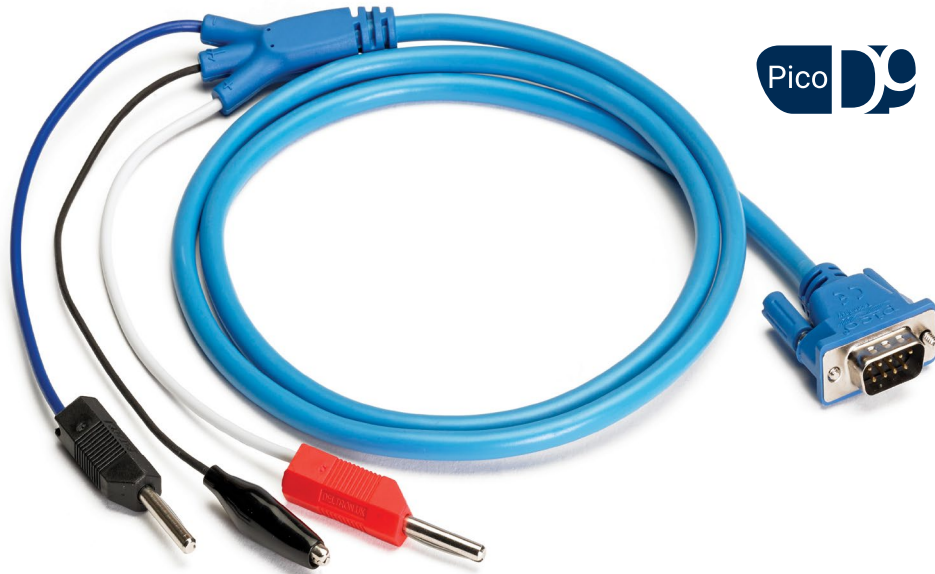

The PicoConnect 441 is a general-purpose passive differential probe with no attenuation and 15 MHz bandwidth, precisely measuring voltages on ranges from ± 10 mV to ± 50 V. The probe is fitted with a ground reference clip, as well as the usual positive and negative leads, to eliminate unknown common mode voltage differences between the probe and the device under test (DUT). It uses unshrouded 4 mm banana leads, so is compatible with a wide range of test probes: it comes with a pair of sprung hook probes.

This probe is ideal for anyone needing to make lower-amplitude, precision measurements in a wide range of applications. You can also use it to measure the differential outputs of differential serial buses such as CAN or RS-485.

PicoConnect 442 probe: 1000 V CAT III test leads

The PicoConnect 442 is a passive differential voltage measurement probe with 25:1 attenuation and 10 MHz bandwidth. It is rated for use up to 1000 V CAT III, and using this probe with the PicoScope 4444 is the most cost-effective way to make these measurements safely on multiple channels. With no need for a battery pack, the PicoConnect 442 is suitable for short- and longer-term voltage measurements.

The probe is double-insulated to eliminate the need for a safety ground. It is fitted with shrouded 4 mm banana leads and comes with a selection of suitable test probes.

Applications for this probe include testing the equipment listed for Overvoltage Category III under EN 61010-1:2010, such as measuring voltages on distribution boards, circuit breakers, and fixed socket outlets.



Current measurement probes (Pico D9)

The TA300 and TA301 both use the Hall effect to measure AC and DC currents, while the TA368 uses the Rogowski coil principle to measure AC current without saturation. The intelligent probe interface means that the probes are powered directly by the PicoScope 4444, so you can use them to measure current for extended periods of time without worrying about flat batteries. It also means that when you connect any of these probes, the PicoScope 6 software automatically configures itself to display your signal.

TA300 current probe



The TA300 current probe is a 40 A AC/DC probe with 100 kHz bandwidth. It is a precision probe for smaller currents, rated for use up to 300 V CAT III on uninsulated conductors.

TA301 current probe



The TA301 current probe is a switched-range 200/2000 A AC/DC probe with 20 kHz bandwidth, rated to 150 V CAT II on uninsulated conductors.

TA368 flexible current probe



The TA368 is a 2000 A AC RMS probe with 10 Hz to 20 kHz bandwidth, rated to 1000 V CAT III and 600 V CAT IV on uninsulated conductors. It has a flexible sensor coil, enabling you to measure currents on hard-to-reach conductors.

OVERVOLTAGE CATEGORIES EXPLAINED

CAT II

Overvoltage Category II is for equipment powered by wiring within the building, whether it is plugged in at a socket or permanently connected.

CAT III

Overvoltage Category III covers the equipment forming the electrical wiring installation of a building, including the circuit breakers, socket outlets and some industrial equipment.

CAT IV

Overvoltage Category IV covers the equipment at the source of the installation, such as electricity meters and primary overcurrent protection devices.

Flexible AC current probes (BNC)

The TA326 and TA325 current probes use the Rogowski coil principle to measure AC currents up to 3000 A, without suffering from saturation. These probes have flexible sensor coils, enabling you to measure currents on conductors that clamp-type current probes just can't get to, while the long battery life means you can leave them connected for longer-term measurements.

Both of these probes are fitted with BNC connectors, so you will need to use TA271 single-ended D9-BNC adaptors to connect them to the PicoScope 4444.

TA326 flexible current probe



The TA326 is a switched-range 30/300/3000 A AC RMS probe with 10 Hz to 20 kHz bandwidth, rated to 1000 V CAT III on uninsulated conductors. Typical battery life is 2000 hours.

You will need one TA271 D9-BNC adaptor in order to use this probe with the PicoScope 4444.

TA325 flexible 3-phase current probe



The TA325 is a switched-range 30/300/3000 A AC RMS probe with 10 Hz to 20 kHz bandwidth, rated to 1000 V CAT III on uninsulated conductors. Suitable for measuring 3-phase AC current, it has three sensor coils and scope connection leads, color-coded to match Channels A, B and C in the PicoScope software. Typical battery life is 1000 hours.

You will need three TA271 D9-BNC adaptors in order to use this probe with the PicoScope 4444.



D9-BNC adaptors: use BNC accessories with the PicoScope 4444

The TA271 D9-BNC adaptor lets you use traditional differential voltage probes and current probes, and make single-ended measurements with a ground-referenced probe. It is also essential when using the TA325 and TA326 current probes.

The TA299 D9-dual BNC adaptor allows you to make differential measurements by connecting two ground-referenced passive probes or cable pairs to one scope input.



PicoScope 6 software

The PicoScope software display can be as basic or as detailed as you need. Begin with a single view of one channel, and then expand the display to include up to four live channels, plus math channels and reference waveforms. Display multiple scope and spectrum views in a configurable grid.

Tools menu: Set up custom probes, serial decoding, reference waveforms, mask tests, alarms and macros from the Tools menu.

Touchscreen controls: Handy buttons make fine adjustments easy on touchscreen devices.

Flexible resolution: Choose between 12- and 14-bit resolution.

Toolbars: Quickly access all the most frequently-used controls from toolbars, leaving the display clear for your waveforms.

Buffer Navigation toolbar: PicoScope can record up to 10 000 of your most recent waveforms. Click through the buffer to look for intermittent events, or use the Buffer Overview thumbnails.

Zooming and Scrolling toolbar: PicoScope makes it easy to zoom in on waveforms, with straightforward zoom-in, zoom-out and pan tools.

Channel options: Adjust settings specific to each channel here.

Auto Setup button: Let PicoScope configure the collection time and input range for a correctly scaled display.

Trigger marker: Drag the marker to adjust the trigger threshold and pre-trigger time.

Adjustable axes: Move the vertical axes up and down the display and vary their scale and offset. PicoScope can also rearrange the axes automatically.

Trigger toolbar: Quick access to the main controls, with advanced triggers in a pop-up window.

Automatic measurements: Add as many calculated time- and frequency-domain measurements as you need, along with statistical parameters showing their variability.

Spectrum view: View frequency-domain data alongside time-domain waveforms or in the dedicated spectrum mode.

Zoom Overview window: Click and drag for quick navigation and adjustment of zoomed views.

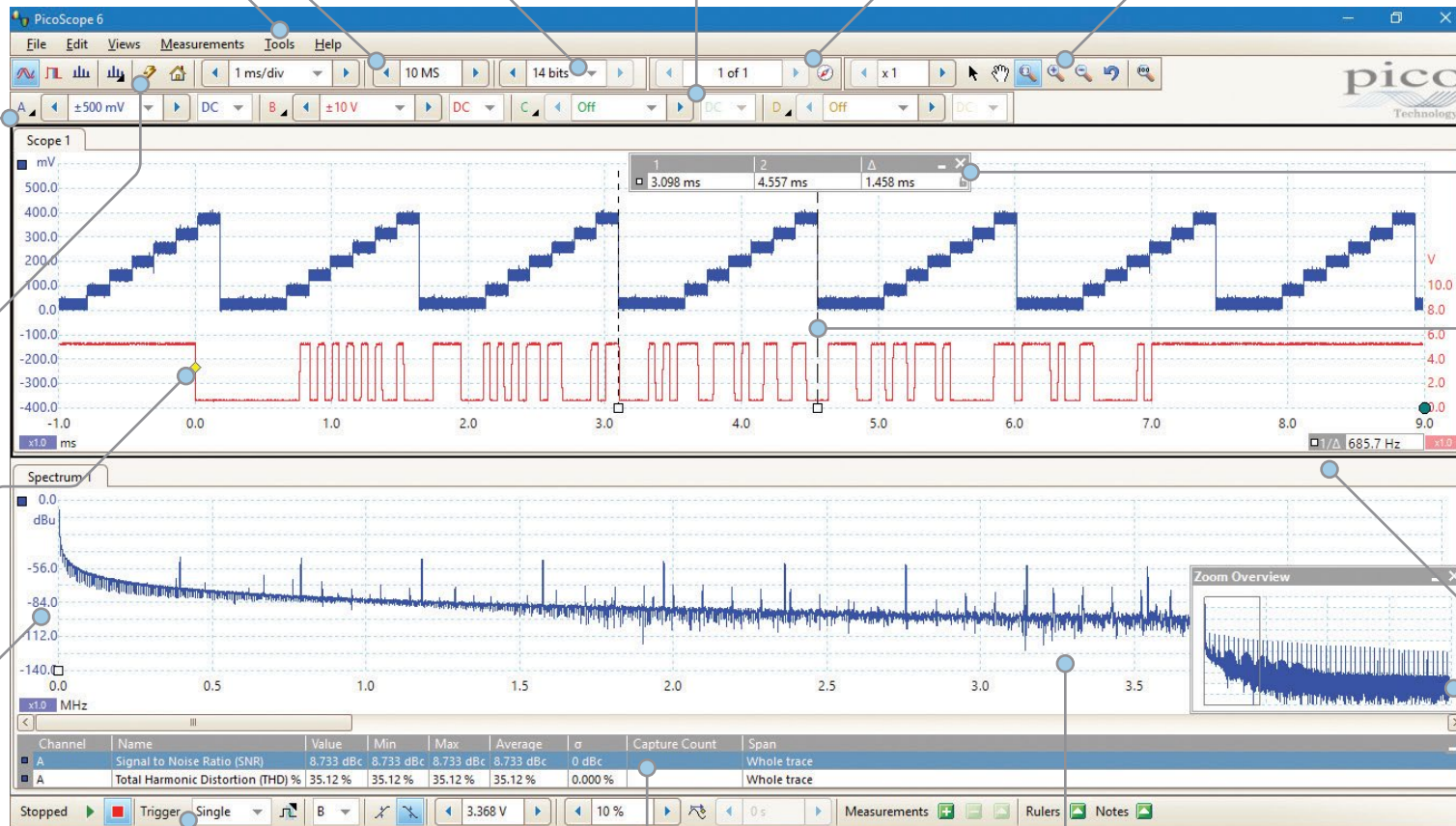

Ruler legend: Absolute and differential ruler measurements are listed here.

Rulers: Each axis has two rulers that you can drag across the screen to make quick measurements.

Views: Add new scope and spectrum views with automatic or custom layouts.

Advanced display

PicoScope 6 software dedicates the majority of the display area to the waveform, ensuring that the maximum amount of data is visible at all times. The size of the display is only limited by the size of your computer's monitor, so even with a laptop, the viewing area is much bigger, with much higher resolution, than that of a benchtop scope.

With such a large display area available, you can create a customizable split-screen display and view multiple channels or different views of the same signal at the same time – the software can even show multiple oscilloscope and spectrum analyzer views at once. Each view has separate zoom, pan and filter settings for ultimate flexibility.

You can control the PicoScope 6 software using a mouse, touchscreen or customizable keyboard shortcuts.

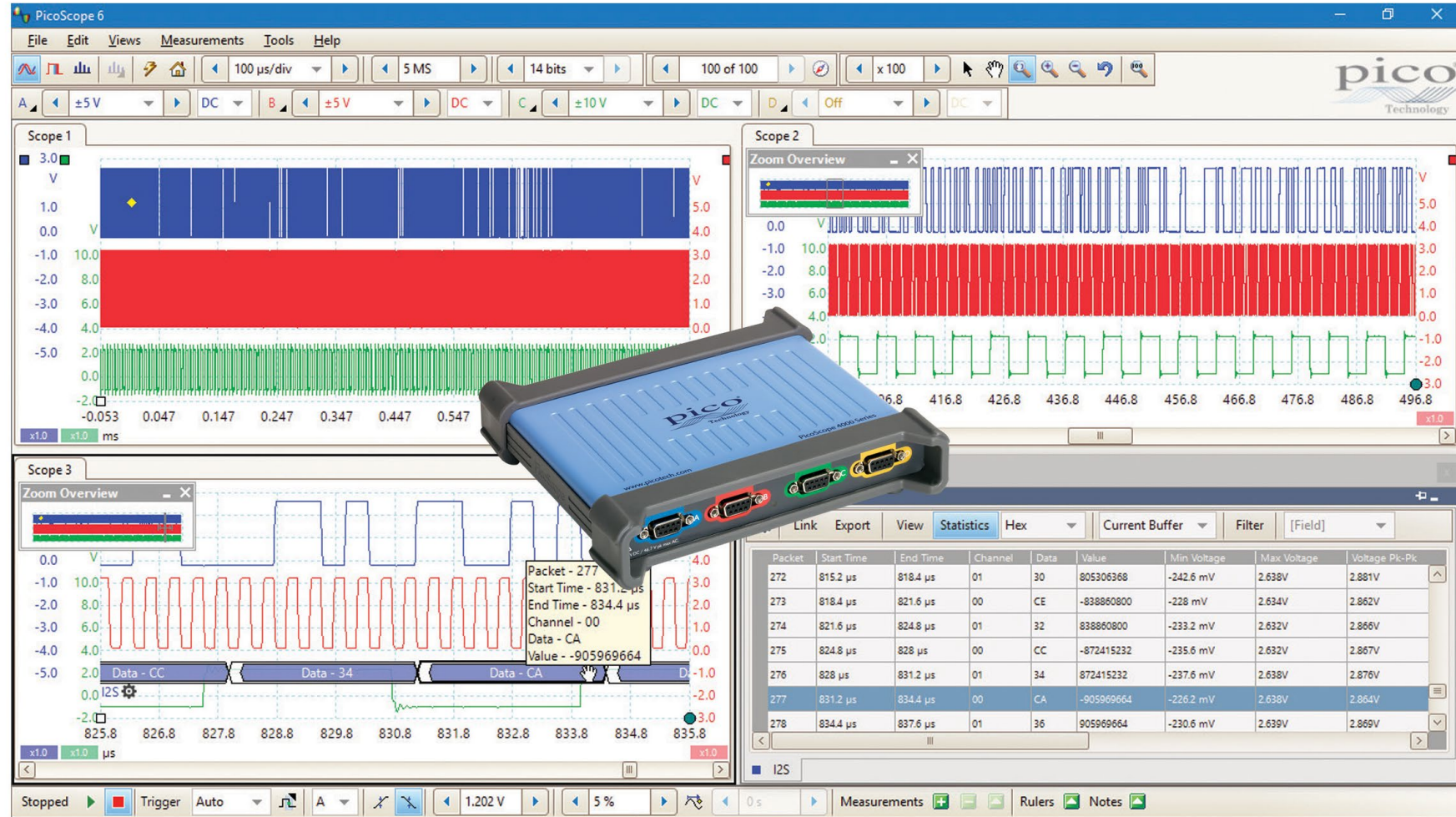

DeepMeasure

The PicoScope 6 DeepMeasure tool uses deep memory to analyze every cycle contained in each triggered waveform acquisition. It displays the results in a table, with the parameter fields shown in columns and waveform cycles shown in rows: you can easily sort the results by any parameter and correlate them with the waveform display.

The current version of the tool includes sixteen parameters per cycle, and can display up to a million cycles.

Parameters include cycle time, frequency, pulse width, duty cycle, rise and fall time, overshoot, undershoot, max voltage and min voltage. Start and end times relative to the trigger are given for each cycle.

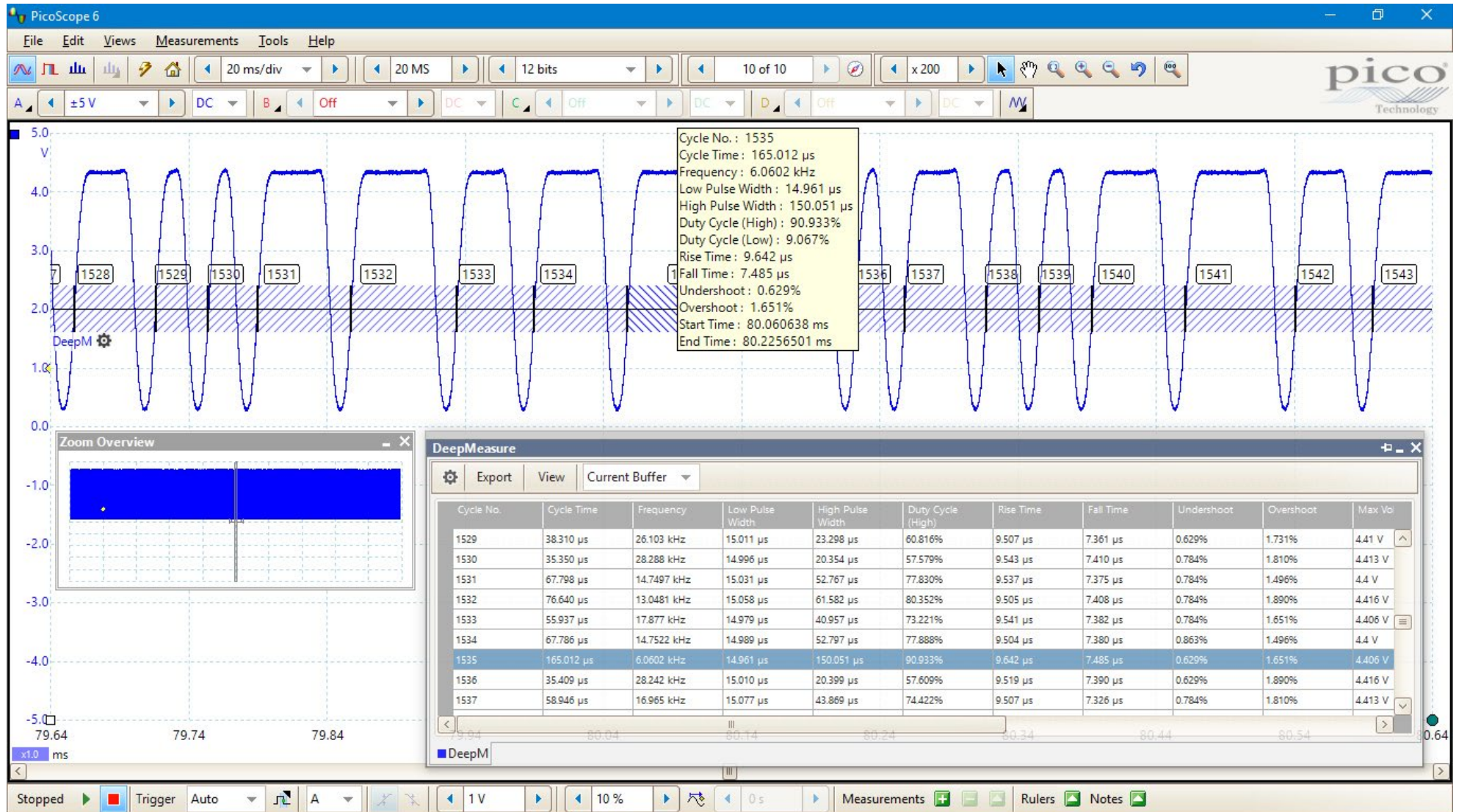

Spectrum analyzer

The spectrum view plots amplitude against frequency and is ideal for finding noise, crosstalk or distortion in signals. PicoScope 6 uses a fast Fourier transform (FFT) spectrum analyzer, which (unlike a traditional swept spectrum analyzer) can display the spectrum of a single, non-repeating waveform.

With a click of a button, you can display a spectrum plot of the active channels, with a maximum frequency of up to 200 MHz. A comprehensive range of settings gives you control over the number of spectrum bins, window functions, scaling (including log/log) and display mode (instantaneous, average or peak-hold).

Display multiple spectrum views with different channel selections and zoom factors, and place these alongside time-domain views of the same data. Choose from a number of automatic frequency-domain measurements to add to the display, including THD, THD+N, SNR, SINAD and IMD. You can apply mask limit testing to a spectrum and can even use the AWG and spectrum mode together to perform swept scalar network analysis.

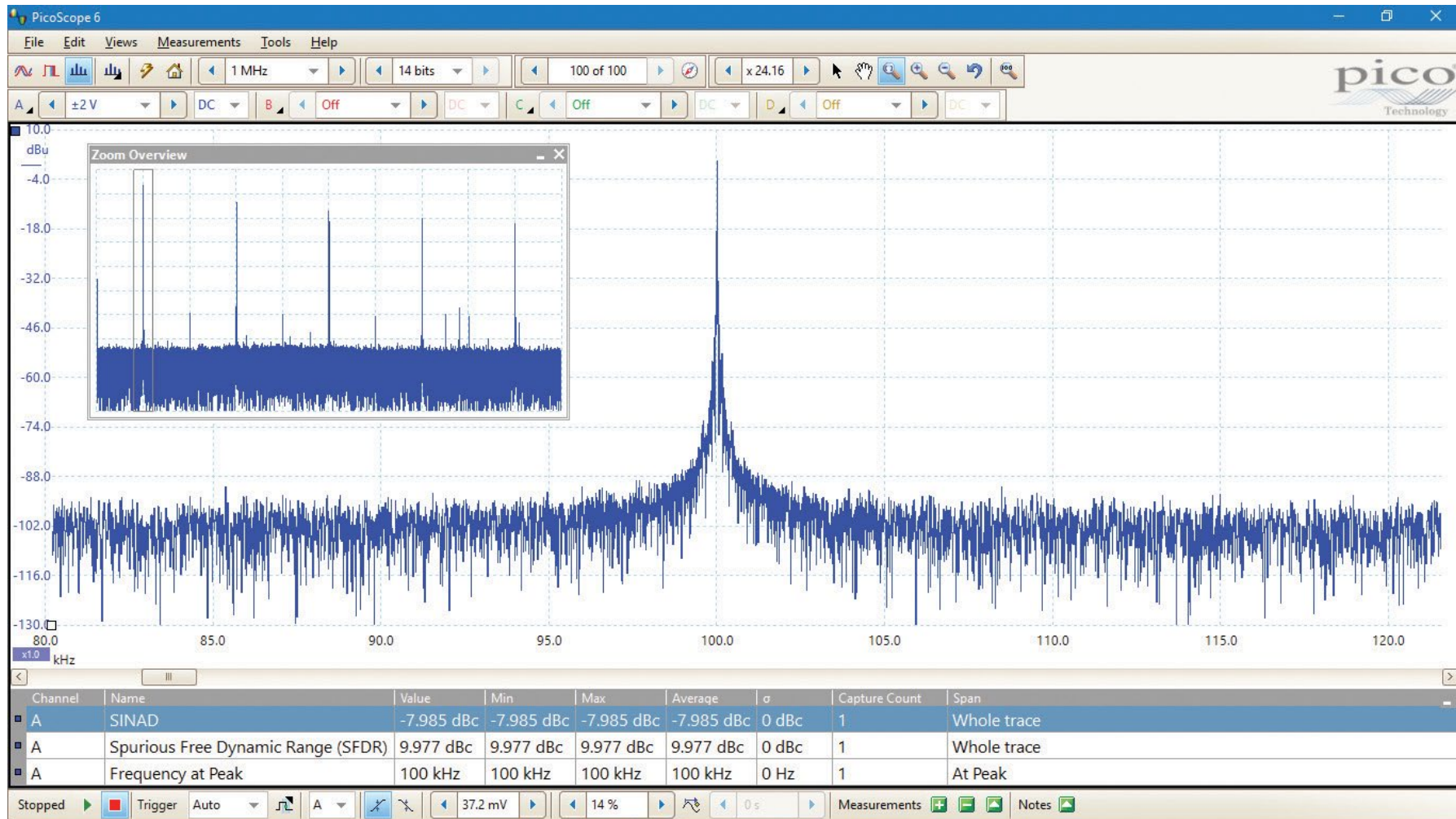

Serial decoding

All PicoScope oscilloscopes include serial decoding and analysis as standard. The PicoScope 6 software has support for 20 protocols including I²C, SPI, CAN, RS-232, Manchester and DALI.

Decoding helps you see what is happening in your design to identify programming and timing errors and check for other signal integrity issues. Timing analysis tools help to show the performance of each design element, identifying parts of the design that need to be improved to optimize overall system performance.

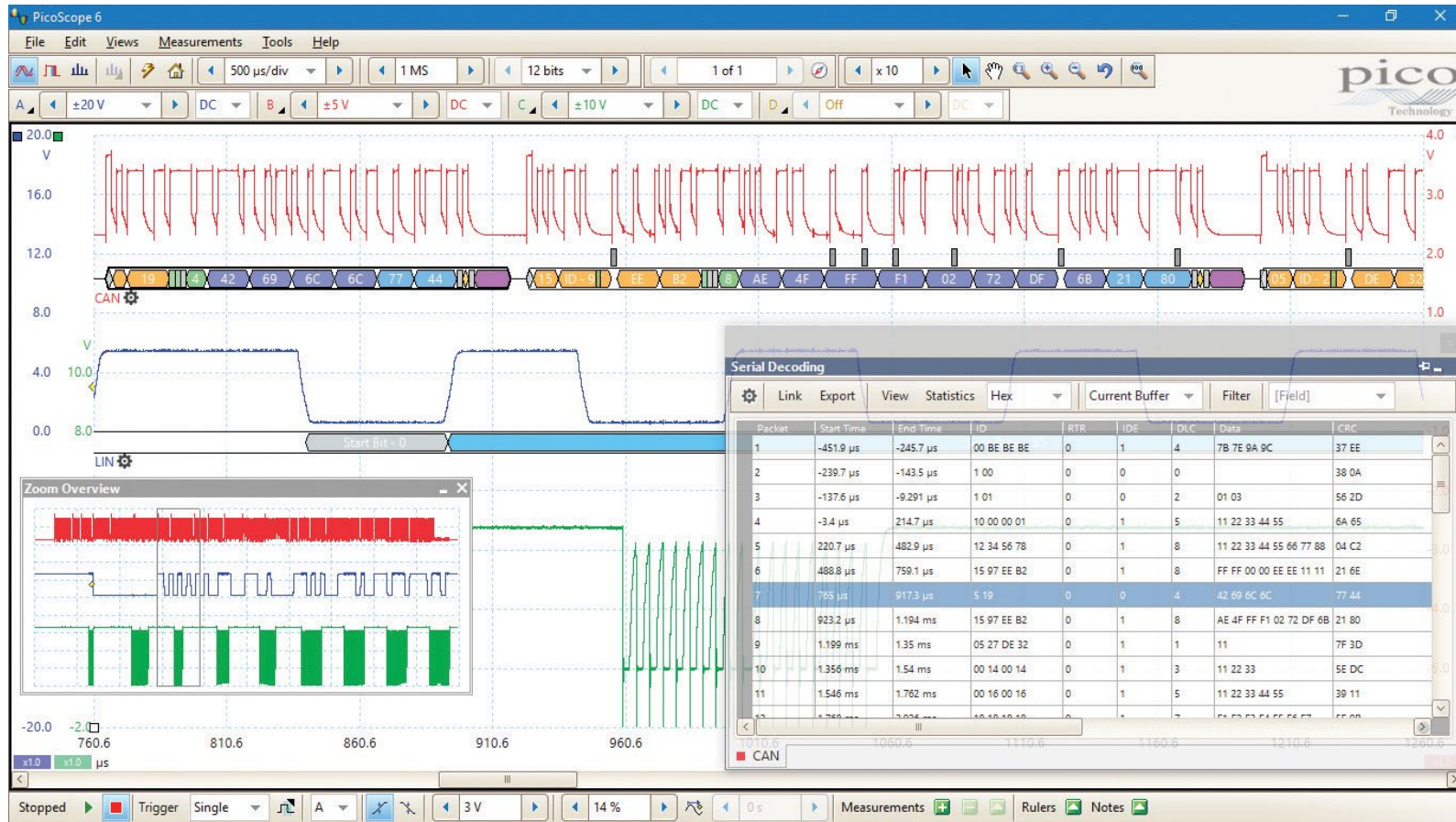

Graph format shows the decoded data (in hex, binary, decimal or ASCII) in a timing diagram format, beneath the waveform on a common time axis, with error frames marked in red.

You can zoom in on these frames to investigate noise or distortion, and each packet field is assigned a different color, so the data is easy to read.

Table format shows a list of the decoded frames, including the data and all flags and identifiers. You can set up filtering conditions to display only the frames you are interested in or search for frames with specified properties.

The statistics option reveals more detail about the physical layer such as frame times and voltage levels. PicoScope 6 can also import a spreadsheet to decode the data into user-defined text strings.

Advanced digital triggers

In 1991, Pico Technology pioneered the use of digital triggering and precision hysteresis using the actual digitized data. Traditionally, digital oscilloscopes have used an analog trigger architecture based on comparators, which can cause time and amplitude errors that cannot always be calibrated out. Additionally, the use of comparators can often limit the trigger sensitivity at high bandwidths and can create a long trigger rearm delay.

Pico's technique of fully digital triggering reduces trigger errors and allows our oscilloscopes to trigger on the smallest signals, even at the full bandwidth, so you can set trigger levels and hysteresis with high precision and resolution.

The digital trigger architecture also reduces the rearm delay. Combined with the segmented memory, this enables you to use rapid triggering to capture 10 000 waveforms in under 12 ms in 8-bit mode.

The PicoScope 4444 offers an industry-leading set of advanced triggers including:

- **Pulse-width trigger:** allows you to trigger on either high or low pulses which are shorter or longer than a specified time or which fall inside or outside a range of times.
- **Interval trigger:** measures the time between subsequent rising or falling edges. This allows you to trigger if a clock signal falls outside of an acceptable frequency range, for example.
- **Dropout trigger:** fires when a signal stops toggling for a defined interval of time, functioning as a watchdog timer.

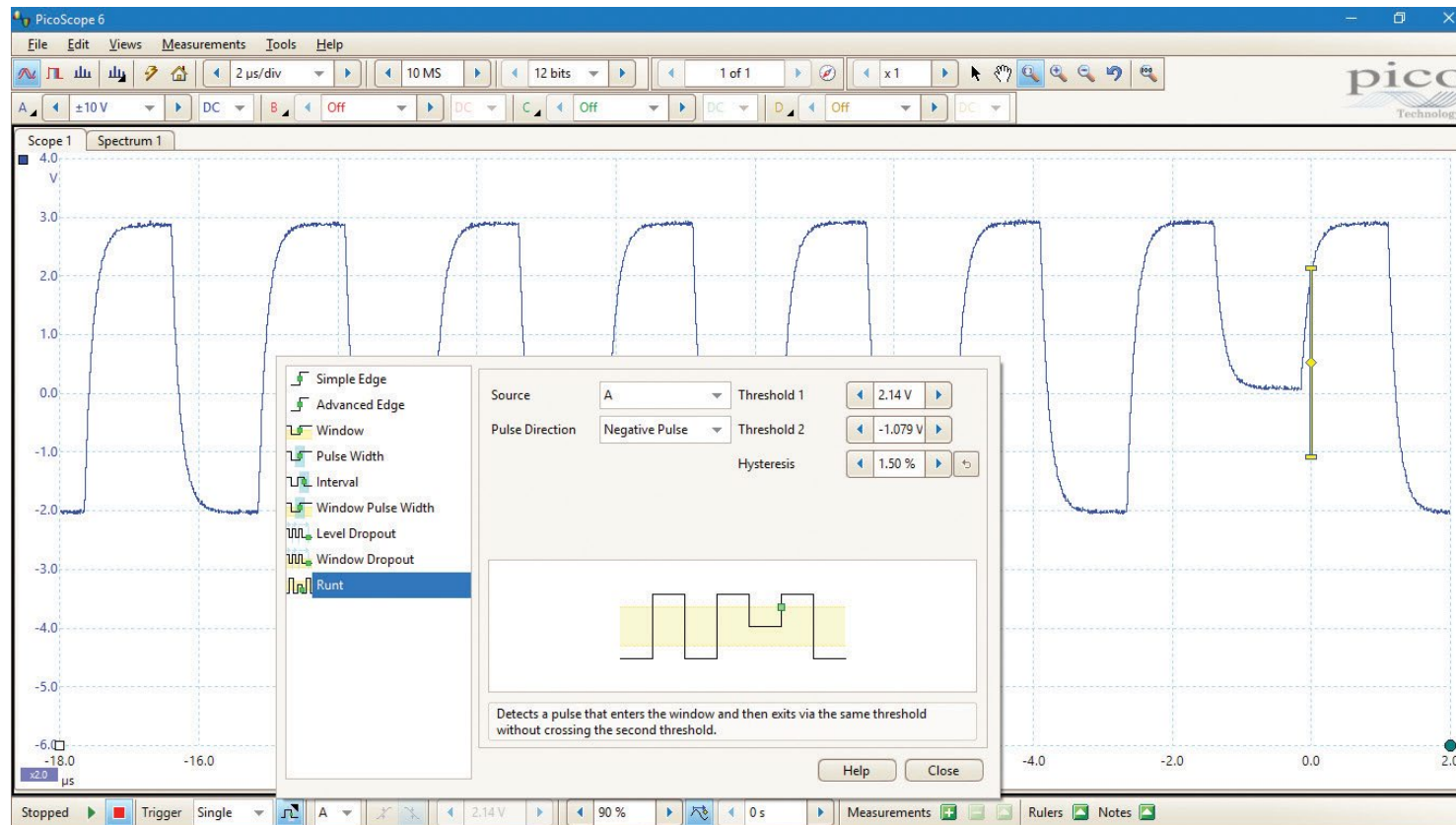

Mask limit testing

Mask limit testing allows you to compare live signals against known good signals, and is designed for production and debugging environments. Simply capture a known good signal, generate a mask around it, and then use the alarms to automatically save any waveform (complete with a time stamp) that violates the mask. PicoScope will capture any intermittent glitches and show a failure count and other statistics in the Measurements window (which you can still use for other measurements). You can also set the waveform buffer navigator to show only mask fails, enabling you to find any glitches quickly. Mask files are easy to edit (numerically or graphically), import and export, and you can simultaneously run mask limit tests on multiple channels and in multiple viewports.

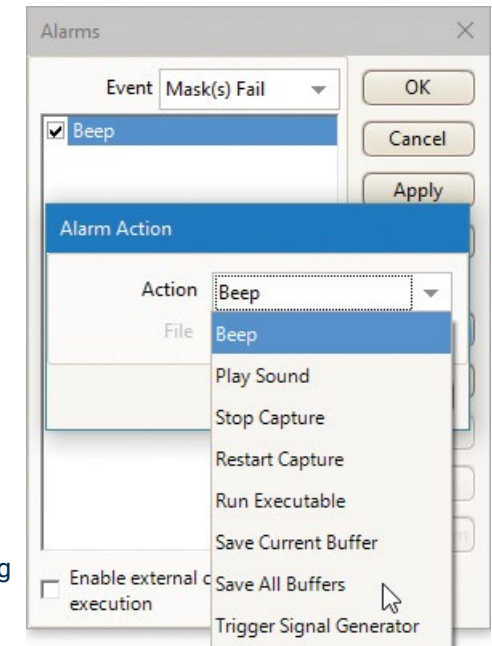
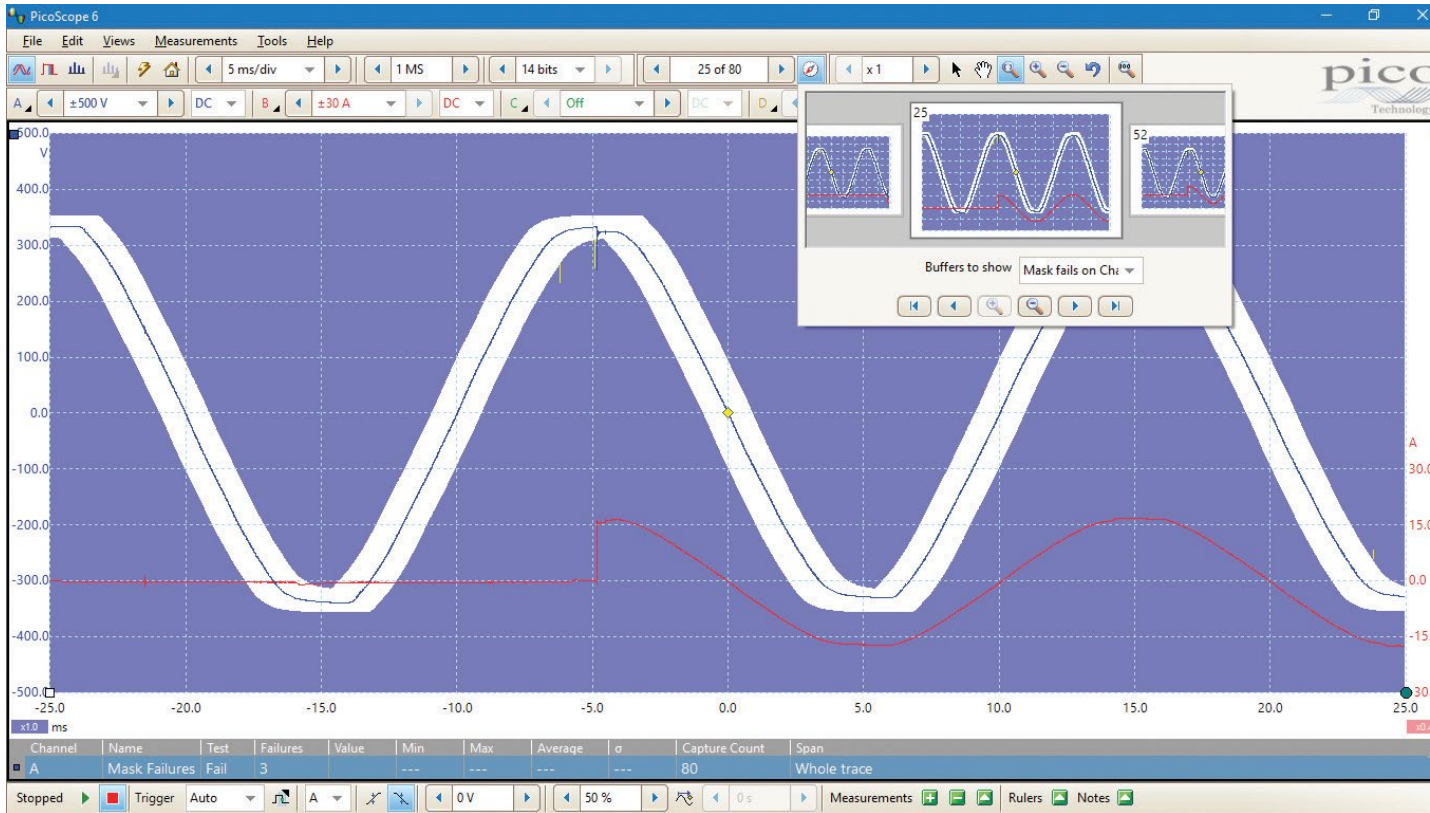

Alarms

You can program PicoScope 6 to execute actions when certain events occur. These events include mask limit fails, trigger events and buffers full.

PicoScope 6 actions include saving a file, playing a sound, executing a program and triggering the arbitrary waveform generator.

Plot frequency against time with PicoScope 6

All oscilloscopes can measure the frequency of a waveform, but often you need to know how that frequency changes over time, which is a difficult measurement to make.

The **freq** math function can do exactly this: in this example, it is being used to plot the frequency of the top waveform, revealing that it is exponentially modulated. Adding time and signal rulers allows measurement of the period and range of this modulation.

You can also use the **duty** function to plot duty cycle in a similar way.

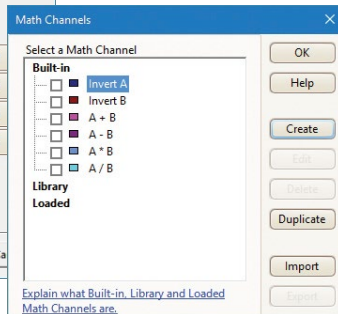
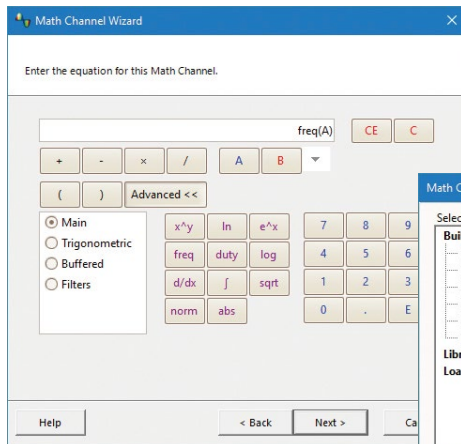
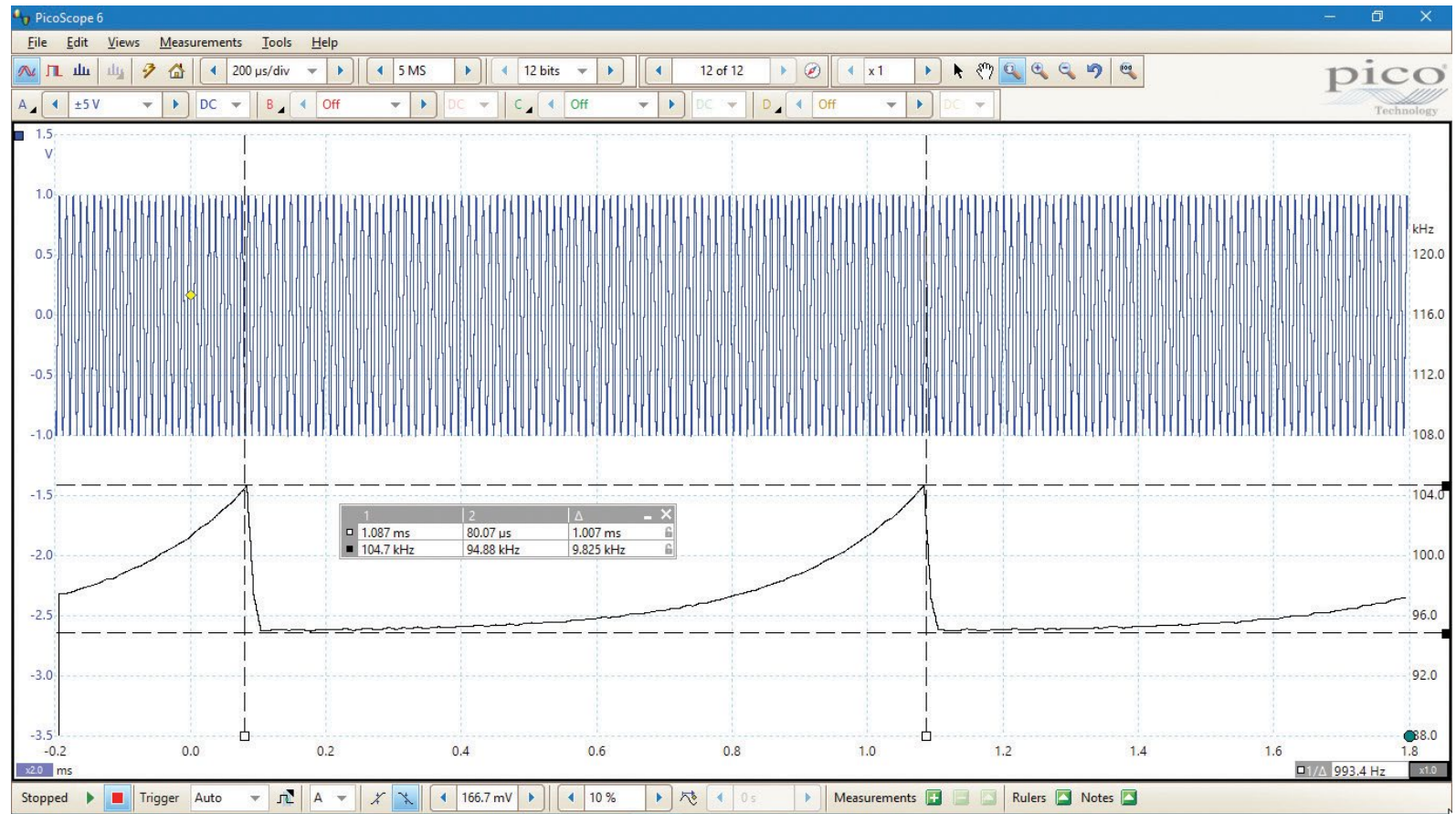

Math channels

With PicoScope 6 you can perform a variety of mathematical calculations on your input signals and reference waveforms.

Use the built-in list for simple functions such as add and invert, or open the wizard and create complex functions involving trigonometry, exponentials, logarithms, statistics, integrals and derivatives.

PicoLog® 6 support

The PicoScope 4444 is now supported in PicoLog 6, allowing you to use multiple units simultaneously, so it is possible to view and record 3-phase voltage and 3-phase current on one capture with two PicoScope 4444s.

PicoLog 6 allows sample rates of up to 1 kS/s per channel, and is ideal for long-term observation of parameters such as phase, voltage and current levels on several channels at the same time, such as when monitoring building and HVAC power usage. It is less suitable for waveshape or harmonic analysis: use the PicoScope 6 software for these tasks.

You can also use PicoLog 6 to view data from oscilloscope alongside a data logger or other device. In the example below, for instance, a PicoScope 4444 is logging 3-phase current alongside a [PicoLog CM3 current data logger](#).

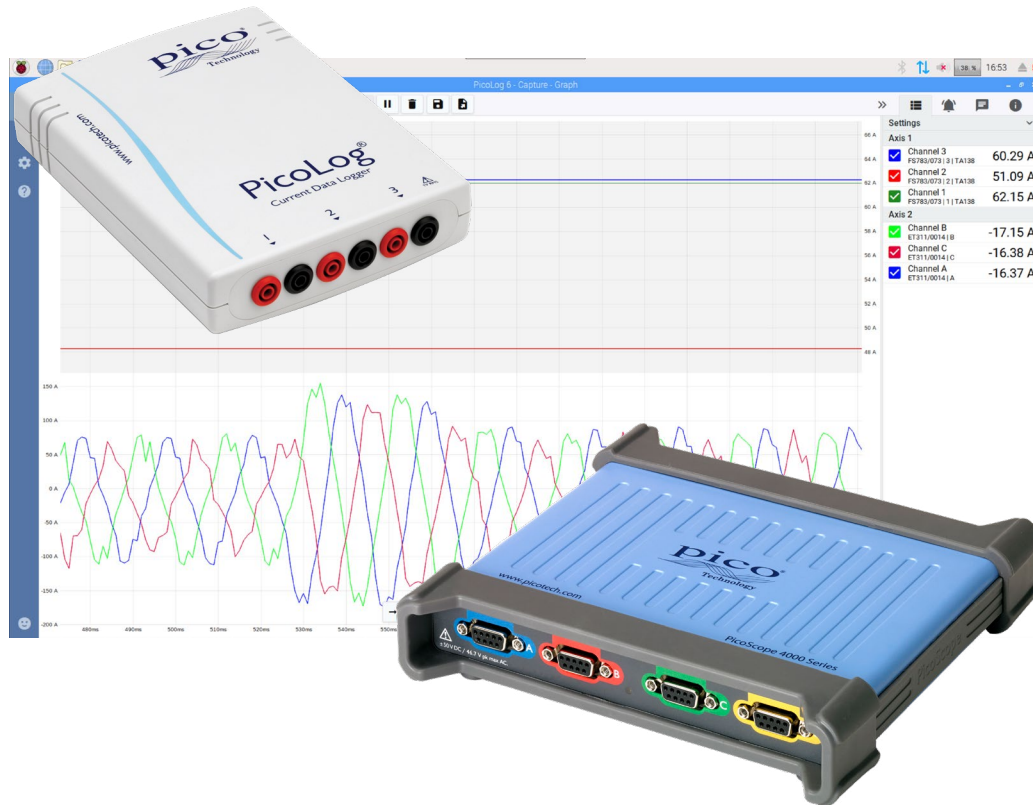

PicoSDK® – write your own apps

Our software development kit, PicoSDK, allows you to write your own software and includes drivers for Windows, macOS and Linux. Example code supplied on our [GitHub](#) organization page shows how to interface to third-party software packages such as National Instruments LabVIEW, and how to use our MathWorks MATLAB instrument drivers.

Amongst other features, the drivers support data streaming, a mode that captures continuous gap-free data directly to your PC at rates of up to 50 MS/s, so you are not limited by the size of your scope's capture memory. Sampling rates in streaming mode are subject to PC specifications and application loading.

There is also an active community of PicoScope 6 users who share both code and whole applications on our [Test and Measurement Forum](#) and the [PicoApps](#) section of the website.



Specifications

VERTICAL	OSCILLOSCOPE SPECIFICATIONS	SPECIFICATIONS WITH PICOCONNECT 442 1000 V CAT III PROBE
Input channels	4 channels	One differential pair per connected probe
Analog bandwidth (-3 dB)	20 MHz with D9-BNC adaptors 15 MHz with PicoConnect 441 probe	10 MHz
Rise time (calculated)	17.5 ns with D9-BNC adaptors 23.3 ns with PicoConnect 441 probe	35 ns
Bandwidth limiter	100 kHz or 1 MHz (selectable)	100 kHz or 1 MHz (selectable)
Vertical resolution, 12-bit mode	12 bits on most input ranges 11 bits on ± 10 mV range	12 bits
Vertical resolution, 14-bit mode	14 bits on most input ranges 13 bits on ± 20 mV range 12 bits on ± 10 mV range	14 bits
Enhanced vertical resolution (PicoScope 6 software), 12-bit mode	Up to 16 bits on most input ranges Up to 15 bits on ± 10 mV range	Up to 16 bits
Enhanced vertical resolution (PicoScope 6 software), 14-bit mode	Up to 18 bits on most input ranges Up to 17 bits on ± 20 mV range Up to 16 bits on ± 10 mV range	Up to 18 bits
Input type	Differential 9-pin D-subminiature, female	Differential 2 x 4 mm sockets, shrouded
Input characteristics	1 M Ω $\pm 1\%$, in parallel with 17.5 pF ± 1 pF (each differential input to scope ground). <1 pF difference between ranges.	16.7 M Ω $\pm 1\%$, in parallel with 9.3 pF ± 1 pF (each differential input to scope ground)
Input coupling	AC or DC (selectable)	AC or DC (selectable)
Input sensitivity	2 mV/div to 10 V/div	± 0.5 V/div to ± 200 V/div
Input ranges (full scale)	± 10 mV, ± 20 mV, ± 50 mV, ± 100 mV, ± 200 mV, ± 500 mV, ± 1 V, ± 2 V, ± 5 V, ± 10 V, ± 20 V, ± 50 V	± 2.5 V, ± 5 V, ± 12.5 V, ± 25 V, ± 50 V, ± 125 V, ± 250 V, ± 500 V, ± 1000 V
Input common mode range	5 V on ± 10 mV to ± 500 mV ranges 50 V on ± 1 V to ± 50 V ranges	125 V on ± 2.5 V to ± 12.5 V ranges 1000 V on ± 25 V to ± 1000 V ranges
DC accuracy (DC to 10 kHz)	$\pm 1\%$ of full scale, ± 500 μ V	$\pm 3\%$ of full scale, ± 12.5 mV
Analog offset range	± 250 mV on ± 10 mV to ± 500 mV ranges ± 2.5 V on ± 1 V to ± 5 V ranges ± 25 V on ± 10 V to ± 50 V ranges	± 6.25 V on ± 2.5 V to ± 12.5 V ranges ± 62.5 V on ± 25 V to ± 125 V ranges ± 625 V on ± 250 V to ± 1000 V ranges
Analog offset accuracy	1% of offset setting in addition to basic DC accuracy	1% of offset setting in addition to basic DC accuracy
Overvoltage protection	± 100 V DC + AC peak (any differential input to ground) ± 100 V DC + AC peak (between differential inputs)	1000 V CAT III (any differential input to ground) 1000 V CAT III (between differential inputs)

HORIZONTAL	
Maximum sampling rate (real time) 12-bit mode	1 channel: 400 MS/s 2 channels: 200 MS/s 3 or 4 channels: 100 MS/s
Maximum sampling rate (real time) 14-bit mode	1 channel: 50 MS/s 2 channels: 50 MS/s 3 or 4 channels: 50 MS/s
Maximum sampling rate (USB streaming)	16.67 MS/s
Capture memory (real time)	256 MS shared between active channels
Capture memory (USB streaming)	100 MS (shared between active channels)
Maximum duration of capture at fastest sampling rate (real time), 12-bit mode	500 ms
Maximum duration of capture at fastest sampling rate (real time), 14-bit mode	5 s
Maximum waveform buffer segments	10 000
Fastest real-time collection time, 12-bit mode	50 ns (5 ns/div)
Fastest real-time collection time, 14-bit mode	200 ns (20 ns/div)
Slowest real-time collection time	50 000 s (5000 s/div)
Collection time accuracy	±50 ppm (5 ppm/year aging)
Sample jitter	3 ps RMS typical
ADC sampling	Simultaneous sampling on all enabled channels

DYNAMIC PERFORMANCE (TYPICAL)		
	OSCILLOSCOPE SPECIFICATIONS	SPECIFICATIONS WITH PICOCONNECT 442 1000 V CAT III PROBE
Crosstalk	2000:1 DC to 20 MHz	2000:1 DC to 10 MHz
Harmonic distortion at 100 kHz, 90% of full scale	< -70 dB on ±50 mV ranges and higher < -60 dB on ±10 mV and ±20 mV ranges	< -70 dB
SFDR	> 70 dB	> 70 dB
ADC ENOB, 12-bit mode	10.8 bits	10.8 bits
ADC ENOB, 14-bit mode	11.8 bits	11.8 bits
Noise	< 180 µV RMS on ±10 mV range	< 5 mV RMS on ±2.5 V range
Bandwidth flatness	(+0.1 dB, -3 dB) DC to full bandwidth	(+0.1 dB, -3 dB) DC to full bandwidth
Common mode rejection ratio	60 dB typical, DC to 1 MHz	55 dB typical, DC to 1 MHz

TRIGGERING	
Source	Any channel
Trigger modes	None, auto, repeat, single, rapid
Trigger types	Edge, window, pulse width, window pulse width, dropout, window dropout, interval, runt pulse, logic
Trigger sensitivity	Digital triggering provides up to 1 LSB accuracy up to full bandwidth
Maximum pre-trigger capture	100% capture length
Maximum trigger time-delay	4 billion samples
Trigger rearm time	< 2 μ s on fastest timebase
Maximum trigger rate	10 000 waveforms in a 12 ms burst
PROBE COMPENSATION PINS	
Output level	4 V peak
Output impedance	610 Ω
Output waveforms	Square wave
Output frequency	1 kHz
Overvoltage protection	\pm 10 V
MATH CHANNELS	
Functions	-x, x+y, x-y, x*y, x/y, x^y, sqrt, exp, ln, log, abs, norm, sign, sin, cos, tan, arcsin, arccos, arctan, sinh, cosh, tanh, freq, derivative, integral, min, max, average, peak, delay, duty, highpass, lowpass, bandpass, bandstop
Operands	A, B, C, D, T (time), reference waveforms, constants, pi
AUTOMATIC MEASUREMENTS	
Scope mode	AC RMS, true RMS, frequency, cycle time, duty cycle, DC average, edge count, falling edge count, rising edge count, falling rate, rising rate, low pulse width, high pulse width, fall time, rise time, minimum, maximum, peak to peak
Spectrum mode	Frequency at peak, amplitude at peak, average amplitude at peak, total power, THD %, THD dB, THD+N, SFDR, SINAD, SNR, IMD
Statistics	Minimum, maximum, average and standard deviation
SERIAL DECODING	
Protocols	1-Wire, ARINC 429, CAN, CAN FD, DALI, DCC, DMX512, Ethernet 10Base-T, FlexRay, I ² C, I ² S, LIN, Manchester, Modbus ASCII, Modbus RTU, PS/2, SENT, SPI, UART (RS-232 / RS-422 / RS-485), USB 1.0/1.1
MASK LIMIT TESTING	
Statistics	Pass/fail, failure count, total count
SDK/API DETAILS AND SPECIFICATIONS FOR USERS WRITING THEIR OWN SOFTWARE (see "HORIZONTAL" above for details when using PicoScope 6 software)	
Supplied drivers	32- and 64-bit drivers for Windows 7, 8 and 10 Linux drivers (including armhf drivers) macOS drivers
Example code	C, C#, Excel VBA, VB.NET, LabVIEW, MATLAB
Maximum sampling rate (USB streaming)	50 MS/s
Capture memory (USB streaming)	Up to available PC memory
Segmented memory buffers	> 1 million

GENERAL SPECIFICATIONS

Connectivity	USB 3.0, USB 2.0
Device connector type	USB 3.0, Type B
Power requirements	USB port or external DC PSU, depending on connected accessories
Dimensions	190 x 170 x 40 mm including connectors
Weight	< 0.5 kg
Temperature range, operating	0 °C to 45 °C
Temperature range, operating, for quoted accuracy	15 °C to 30 °C
Temperature range, storage	-20 °C to 60 °C
Humidity range, operating	5% to 80% RH non-condensing
Humidity range, storage	5% to 95% RH non-condensing
Altitude	Up to 2000 m
Pollution degree	Pollution degree 2
Safety approvals	Designed to EN 61010-1:2010
EMC approvals	Tested to EN 61326-1:2013 and FCC Part 15 Subpart B
Environmental approvals	RoHS and WEEE compliant

SOFTWARE AVAILABILITY AND REQUIREMENTS (HARDWARE REQUIREMENTS AS OPERATING SYSTEM)

Windows software	PicoScope 6, PicoLog 6, PicoSDK See PicoScope and PicoLog release notes for supported OS versions
macOS software	PicoScope 6 Beta (including drivers), PicoLog 6 (including drivers) See PicoScope and PicoLog release notes for supported OS versions
Linux software	PicoScope 6 Beta software and drivers, PicoLog 6 (including drivers) See PicoScope and PicoLog release notes for supported distributions See Linux Software and Drivers to install drivers only
Raspberry Pi OS for 3B and 4B	PicoLog 6 (including drivers) See PicoLog release notes for supported OS versions See Linux Software and Drivers to install drivers only
Languages supported, PicoScope 6	Simplified Chinese, Czech, Danish, Dutch, English, Finnish, French, German, Greek, Hungarian, Italian, Japanese, Korean, Norwegian, Polish, Portuguese, Romanian, Russian, Spanish, Swedish, Turkish
Languages supported, PicoLog 6	Simplified Chinese, English (UK), English (US), French, German, Italian, Japanese, Korean, Russian, Spanish
Users writing their own apps can find example programs for all platforms on the Pico Technology organization page on GitHub .	

Ordering information

Oscilloscope kits

Order code	Product name	Description
PQ073	Extra low voltage differential kit	PicoScope 4444 plus 3× PicoConnect 441 probes and 1× TA271 D9-BNC adaptor
PQ074	1000 V CAT III mains voltage kit	PicoScope 4444 plus 3× PicoConnect 442 probes and 1× TA271 D9-BNC adaptor
PQ167	1000 V CAT III mains voltage and current kit	PicoScope 4444 plus 3× PicoConnect 442 probes, 3× TA368 flex current probes and 1× TA271 D9-BNC adaptor
PQ088	PicoScope 4444 oscilloscope	Oscilloscope only. Must be purchased with at least one of the Pico D9 accessories listed below.

Accessories

Order code	Product name	Description	Connector
PQ098	PicoConnect 441 probe*	Passive differential 1:1 15 MHz voltage measurement probe.	Pico D9
PQ087	PicoConnect 442 probe*	1000 V CAT III, passive differential 25:1 10 MHz voltage measurement probe.	Pico D9
TA300	TA300 AC/DC current probe	40 A AC/DC, 300 V CAT III, 100 kHz current measurement probe	Pico D9
TA301	TA301 AC/DC current probe	200/2000 A AC/DC, 150 V CAT II, 20 kHz current measurement probe	Pico D9
TA368	TA368 flex current probe	Flexible single-phase 2000 A AC RMS, 1000 V CAT III, 600 V CAT IV, 10 Hz to 20 kHz current probe	Pico D9
TA325	TA325 flex current probe 3-phase	Flexible 3-phase switched-range 30/300/3000 A AC RMS, 1000 V CAT III, 10 Hz to 20 kHz current probe. Requires 3x TA271 D9-BNC adaptor (sold separately).	3x BNC
TA326	TA326 flex current probe	Flexible single-phase switched-range 30/300/3000 A AC RMS, 1000 V CAT III, 10 Hz to 20 kHz current probe. Requires 1x TA271 D9-BNC adaptor (sold separately).	BNC
TA271	TA271 D9-BNC adaptor	D9-BNC adaptor suitable for ground-referenced measurements using a single probe	Pico D9
TA299	TA299 D9-dual BNC adaptor	D9-dual BNC adaptor suitable for differential measurements using two single-ended probes	Pico D9
PA149	Carry case	Portable carry case to hold the PicoConnect 4444 and its accessories	N/A

Calibration service

Order code	Model name	Description
CC045	Calibration certificate CC045	Calibration certificate for PicoScope 4444 differential oscilloscope

* Additional accessories are available for the PicoConnect 441 and 442 probes: see online for details.

More products in the Pico Technology range...

PicoLog CM3 Current Data Logger



3-channel data logger using industry-standard AC current clamps.

Ideal for measuring the current consumption of buildings and machinery.

USB and Ethernet interfaces for local or remote data logging.

PicoScope 4824



8-channel, 12-bit oscilloscope with 20 MHz bandwidth and 256 MS capture memory, plus function generator and AWG.

Ideally suited to power measurement, or for debugging complex embedded systems.

PicoScope 5000 Series



Why choose between fast sampling and high resolution? PicoScope 5000 Series FlexRes® scopes let you choose the resolution, from 8 to 16 bits.

Up to 200 MHz bandwidth and 512 MS capture memory, with mixed-signal models available.

PicoScope 9400 Series SXRTOs



4-channel, 12-bit, 5 and 16 GHz sampler-extended real-time oscilloscopes. Capture pulse and step transitions down to 22 ps and clocks and data eyes to 8 Gb/s.

Comprehensive RF, microwave and gigabit visualization and measurement in a compact, portable and affordable instrument.

Deutschlands größter B2B-Onlineshop für Mess- und Prüftechnik.

dataTec

Mess- und Prüftechnik. Die Experten.

Ihre Vorteile:

- > Eine unschlagbare Auswahl namhafter Hersteller
- > Hohe Lagerkapazität und kurze Wege
- > Bundesweite Lieferung und schnelle Zustellung meist innerhalb eines Tages
- > Mehrere tausend Mess- und Prüfgeräte
- > Tagesaktuelle Preise und Promotions
- > Warenkorbrabatt bei Online-Bestellung
- > Versandkostenfrei ab € 50,-
- > Dokumenten-Download u. v. m.

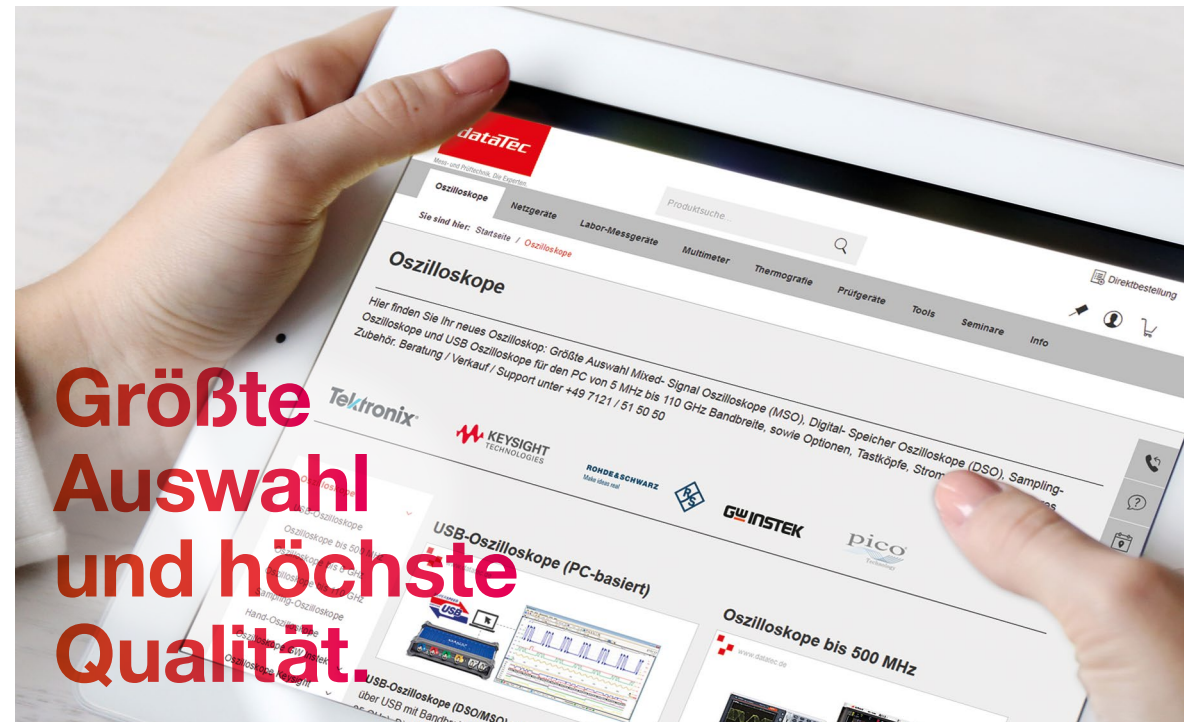

Wir haben die Lösungen für Ihre Messaufgaben.

dataTec

Mess- und Prüftechnik. Die Experten.

Ihre Vorteile:

- > Diplom-Ingenieure, Elektronik- und Elektrotechniker
- > Langjährige Praxiserfahrung und hohe Kompetenz
- > Bundesweit über 20 praxiserfahrene und herstellerzertifizierte Vertriebsingenieure im Außendienst bei Ihnen vor Ort

Experten für:

- > Oszilloskope
- > Spektrum- / Netzwerkanalysatoren
- > Netzgeräte / Stromversorgungen
- > Thermografie / Temperatur
- > Prüfgeräte VDE / Netzanalyse u. v. m.



Mit unserer Akademie kommen Sie weiter.

dataTec

AKADEMIE

Ihre Vorteile:

- > Wissenstransfer zu sämtlichen Bereichen der Messtechnik, immer auf dem neuesten Stand
- > Vielfältiges Seminarangebot mit renommierten Dozenten, in Theorie und Praxis
- > Modernste Räumlichkeiten mit bester technischer Ausstattung

Seminarthemen:

- > Prüfgeräte VDE
- > Oszilloskope
- > Labormesstechnik
- > EMV- / HF-Messtechnik u. v. m.

Alle aktuellen Preise und Termine unter:
>>> www.datatec.eu/akademie

