B2900B/BL Series

Precision Source/Measure Unit



dataTec

Mess- und Prüftechnik. Die Experten.

**Ihr Ansprechpartner /
Your Partner:**

dataTec AG

E-Mail: info@datatec.eu

>>> www.datatec.eu



KEYSIGHT

Authorized Premium
Distributor

Notices

Copyright Notice

© Keysight Technologies 2020, 2023

No part of this manual may be reproduced in any form or by any means (including electronic storage and retrieval or translation into a foreign language) without prior agreement and written consent from Keysight Technologies as governed by United States and international copyright laws.

Manual Part Number

B2910-90110

Edition

Edition 2, May 2023

Published by:

Keysight Technologies Japan K.K.
9-1, Takakura-machi, Hachioji-shi, Tokyo
192-8550 Japan

Technology Licenses

The hardware and/or software described in this document are furnished under a license and may be used or copied only in accordance with the terms of such license.

U.S. Government Rights

The Software is “commercial computer software,” as defined by Federal Acquisition Regulation (“FAR”) 2.101. Pursuant to FAR 12.212 and 27.405-3 and Department of Defense FAR Supplement (“DFARS”) 227.7202, the U.S. government acquires commercial computer software under the same terms by which the software is customarily provided to the public. Accordingly, Keysight provides the Software to U.S. government customers under its standard commercial license, which is embodied in its End User License Agreement (EULA), a copy of which can be found at <http://www.keysight.com/find/sweula>. The license set forth in the EULA represents the exclusive authority by which the U.S. government may use, modify, distribute, or disclose the Software. The EULA and the license set forth therein, does not require or permit, among

other things, that Keysight: (1) Furnish technical information related to commercial computer software or commercial computer software documentation that is not customarily provided to the public; or (2) Relinquish to, or otherwise provide, the government rights in excess of these rights customarily provided to the public to use, modify, reproduce, release, perform, display, or disclose commercial computer software or commercial computer software documentation. No additional government requirements beyond those set forth in the EULA shall apply, except to the extent that those terms, rights, or licenses are explicitly required from all providers of commercial computer software pursuant to the FAR and the DFARS and are set forth specifically in writing elsewhere in the EULA. Keysight shall be under no obligation to update, revise or otherwise modify the Software. With respect to any technical data as defined by FAR 2.101, pursuant to FAR 12.211 and 27.404.2 and DFARS 227.7102, the U.S. government acquires no greater than Limited Rights as defined in FAR 27.401 or DFAR 227.7103-5 (c), as applicable in any technical data.

Warranty

THE MATERIAL CONTAINED IN THIS DOCUMENT IS PROVIDED “AS IS,” AND IS SUBJECT TO BEING CHANGED, WITHOUT NOTICE, IN FUTURE EDITIONS. FURTHER, TO THE MAXIMUM EXTENT PERMITTED BY APPLICABLE LAW, KEYSIGHT DISCLAIMS ALL WARRANTIES, EITHER EXPRESS OR IMPLIED, WITH REGARD TO THIS MANUAL AND ANY INFORMATION CONTAINED HEREIN, INCLUDING BUT NOT LIMITED TO THE IMPLIED WARRANTIES OF MERCHANTABILITY AND FITNESS FOR A PARTICULAR PURPOSE. KEYSIGHT SHALL NOT BE LIABLE FOR ERRORS OR FOR INCIDENTAL OR CONSEQUENTIAL DAMAGES IN CONNECTION WITH THE FURNISHING, USE, OR PERFORMANCE OF THIS DOCUMENT OR OF ANY INFORMATION CONTAINED HEREIN. SHOULD KEYSIGHT AND THE USER HAVE A SEPARATE WRITTEN AGREEMENT WITH WARRANTY TERMS COVERING THE MATERIAL IN THIS DOCUMENT THAT CONFLICT WITH THESE

TERMS, THE WARRANTY TERMS IN THE SEPARATE AGREEMENT SHALL CONTROL.

Open Software License

A portion of the software in this product is licensed under terms of the General Public License Version 2 (“GPLv2”). The text of the license and source code can be found at:

www.keysight.com/find/GPLV2

Declaration of Conformity

Declarations of Conformity for this product and for other Keysight products may be downloaded from the Web. Go to <http://www.keysight.com/go/conformity>. You can then search by product number to find the latest Declaration of Conformity.

Latest Information

To get the latest firmware/software/electronic manuals/specifications/support information, go to www.keysight.com and type in the product number in the Search field at the top of the page.

COMPLIANCE WITH GERMAN NOISE REQUIREMENTS

This is to declare that this product is in conformance with the German Regulation on Noise Declaration for Machines (Lärmangabe nach der Maschinenlärminformation-Verordnung -3.GSGV Deutschland).

- Herstellerbescheinigung
GERÄUSCHEMISSION
Lpa < 70 dB
am Arbeitsplatz
normaler Betrieb
nach DIN 45635 T. 19
- Manufacturer's Declaration
ACOUSTIC NOISE EMISSION
Lpa < 70dB
operator position
normal operation
per ISO 7779

South Korean EMC declaration

Information to the user:

This equipment has been conformity assessed for use in business environments. In a residential environment this equipment may cause radio interference.

(*) This EMC statement applies to the equipment only for use in business environment.

사용자안내문
이 기기는 업무용 환경에서 사용할 목적으로 적합성평가를 받은 기기로서 가정용 환경에서 사용하는 경우 전파간섭의 우려가 있습니다.

(*) 사용자 안내문은 “업무용 방송통신기자재”에만 적용한다.

Safety Summary

The following general safety precautions must be observed during all phases of operation, service, and repair of this instrument. Failure to comply with these precautions or with specific warnings elsewhere in this manual may impair the protections provided by the instrument. In addition, it violates safety standards of design, manufacture, and intended use of the instrument. Keysight Technologies assumes no liability for customer's failure to comply with these requirements.

Product manuals may also be available on the Web. Go to www.keysight.com and type the product model number in the Search field at the top of the page. Manuals provided on CD-ROM or in printed form are an option for many products.

NOTE

Do not use this instrument in any manner not specified by the manufacturer. The protective features of this instrument may be impaired if it is used in a manner not specified in the operation instructions.

This instrument is an INDOOR USE product.

This instrument complies with OVERVOLTAGE CATEGORY II for mains input and POLLUTION DEGREE 2 defined in IEC 61010-1.

If an instrument is marked CAT I (IEC Measurement Category I), or it is not marked with a measurement category, its measurement terminals must not be connected to line-voltage mains.

Safety of any system incorporating the equipment is the responsibility of the assembler of the system.

WARNING

Hazardous voltage of up to the instrument's maximum voltage may appear at High Force, Guard, and High Sense terminals if Interlock terminal is closed. Open the Interlock terminal when the High Force, Guard, and High Sense terminals are accessible. Voltage applied to the terminals will be limited up to ± 42 V.

Do not work the interlock function intentionally in order to bring the output voltage to the safe level. While the high voltage indicator is lit, the dangerous voltage by the output voltage or the residual charge appears on the measurement terminal.

- *DANGEROUS PROCEDURE WARNINGS*

Warnings, such as WARNING on the previous page, shall be complied. Procedures throughout in this manual prevent you from potentially hazard. Their instructions contained in the warnings must be followed.

- *BEFORE APPLYING POWER*

Verify that all safety precautions are taken. Make all connections to the instrument before applying power. Note the instrument's external markings described under "Safety Symbols".

- *GROUND THE INSTRUMENT*

This is Safety Class I instrument. To minimize shock hazard, the instrument chassis and cabinet must be connected to an electrical ground. The power terminal and the power cable must meet International Electrotechnical Commission (IEC) safety standards.

- *DO NOT OPERATE IN AN EXPLOSIVE ATMOSPHERE*

Do not operate the instrument in the presence of flammable gases or fumes. Operation of any electrical instrument in such an environment constitutes a definite safety hazard.

- *DO NOT REMOVE COVERS*

No operator serviceable parts inside. Refer servicing to qualified personnel. To prevent electrical shock do not remove covers.

- *IN CASE OF DAMAGE*

Instruments that appear damaged or defective should be made inoperative and secured against unintended operation until they can be repaired by qualified service personnel. Return the instrument to a Keysight Technologies sales or service office for services and repair to ensure that safety features are maintained.

- *USE ONLY THE SPECIFIC ACCESSORIES*

Specific accessories satisfy the requirements for specific characteristics for using the instrument. Use the specific accessories, cables, adapters, and so on for safety reasons.

Safety Symbols

The general definitions of safety symbols used on equipment or in manuals are listed below.

 Direct current.

 Alternating current.

 Earth ground terminal.

 Protective conductor terminal. For protection against electrical shock in case of a fault. Used with field wiring terminals to indicate the terminal which must be connected to ground before operating equipment.

 Frame or chassis terminal. A connection to the frame (chassis) of the equipment which normally includes all exposed metal structures.

 Grounded terminal which indicates the earth potential.

 On supply.

 Off supply.

 Standby supply. The equipment will be marked with this symbol is not completely disconnected from AC mains when power switch is in the standby position.

 In position of a bi-stable push switch.

 Out position of a bi-stable push switch.

 Hazardous voltage and potential for electrical shock. Do not touch terminals that have this symbol when the equipment is on.

 Hot surface. Avoid contact. Surfaces are hot and may cause personal injury if touched.

 Caution, refer to accompanying documentation. The equipment will be marked with this symbol when it is necessary for the user to refer to the instruction manual.

 Read operator's manual. To indicate that the operator's manual or card should be read before continuing the operation.

CAT I IEC Measurement Category I

 The CE mark shows that the product complies with all applicable European Directives.

 The CSA mark is a registered trademark of the Canadian Standards Association.



The RCM mark is a registered trademark of the Australian Communications Authority. This signifies compliance with the Australian EMC Framework Regulations under the terms of the Radio communications Act.

ICES/NMB-001

This ISM device complies with Canadian ICES-001.
Cet appareil ISM est conforme à la norme NMB-001 du Canada.

CAN ICES/NMB-001(A)

This ISM device complies with Canadian ICES-001 Class A.
Cet appareil ISM est conforme à la norme NMB-001 classe A du Canada.

ISM GROUP 1 CLASS A

This is the symbol for an Industrial, Scientific and Medical, Group 1 Class A product. (CISPR 11)



The UKCA mark shows that the product complies with all applicable UK regulations.



Korea's safety and EMC mark



China RoHS - Environmentally Green Product Label



China RoHS - Product with Toxic Substance 40 yr EPUP



The Chinese mark for paper-based packaging materials; Paperboard and Corrugated Fiberboard

CFB



Plastic Material Coding Identification

WARNING

A **WARNING** notice denotes a hazard. It calls attention to an operating procedure, practice, or the like that, if not correctly performed or adhered to, could result in personal injury or death. Do not proceed beyond a **WARNING** notice until the indicated conditions are fully understood and met.

CAUTION

A **CAUTION** notice denotes a hazard. It calls attention to an operating procedure, practice, or the like that, if not correctly performed or adhered to, could result in damage to the product or loss of important data. Do not proceed beyond a **CAUTION** notice until the indicated conditions are fully understood and met.

Power Supply and Measurement Safety

- Power Supply Safety

This instrument can output high currents and voltages. Make sure that the load or device under test can safely handle the output current and voltage. Also, make sure that the connection leads can safely withstand the expected currents and are insulated for the expected voltages.

The instrument outputs may be connected so as to float relative to earth ground. Isolation or floating voltage ratings are indicated on the instrument, near the output terminal or the Chassis ground terminal. There is the danger of electric shock by touching the floated measurement terminals. Keep in mind it to protect yourself. And it is a reason of using the recommended accessories.

- Voltage/Current Measurement Safety

Multimeters and other instruments capable of measuring high voltages and currents are subject to specific safety concerns because of the circuits to which they may be connected. To safely use these instruments, you need to understand the markings on the instrument near the input terminals, which include the Protection Limits and the IEC Measurement Category.

- Protection Limits

Keysight multimeters and other voltage measurement instruments provide protection circuitry to prevent damage to the instrument and to protect against the danger of electric shock, provided the Protection Limits are not exceeded. To ensure safe operation of the instrument, do not exceed the Protection Limits shown on the input terminals.

- Source/Measure Terminals

Source/measure unit, SMU, can simultaneously perform DC voltage or current output and measurement. Typical SMU has the Force, Sense, and Guard terminals as shown below. Normally the Force, Sense, and Guard are the same potential. Voltage marked around the terminals indicates the Protection Limits.

Force and Sense must be connected to a terminal of a device under test (DUT) for the 4-wire connection (Kelvin connection) which is effective for high current measurement and low resistance measurement. For the 2-wire connection to ease the connections, connect Force only. Do not connect Sense. It must be opened.

Guard should be connected to the guard shield which covers the DUT high side wiring for reducing leakage current caused by the wire. Or else, the Guard must be opened.

Chassis ground (green terminal) should be connected to the ground shield which covers the DUT including the guard shield to minimize the affect of noise. Or else, the chassis ground should be opened.

The following image is the source and measurement terminals of Keysight B2900. For the B2900, the High Force, High Sense, and Guard are the same potential. And the Low Force and Low Sense are the same potential.

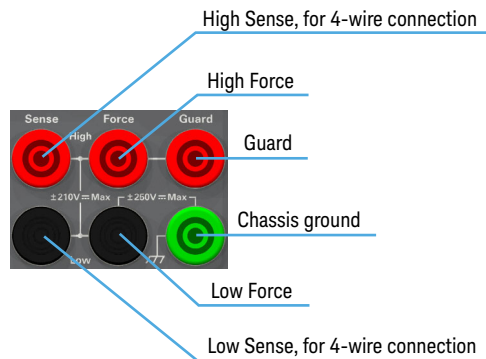



High Voltage Shock Hazard

Keysight B2900 can force dangerous voltages (± 210 V) at the High Force, Guard, and High Sense terminals. To prevent electric shock hazard, the following safety precautions must be observed during the use of Keysight B2900.

- Use a three-conductor AC power cable to appliance coupler (inlet) and the instrument to an electric ground (safety ground).
- Prepare shielding box which covers interface to a device under test and equipped with interlock circuit that opens when the door is opened.
- Before performing measurement, connect the interlock circuit to the Interlock terminal of this instrument.
- Confirm periodically that the interlock function works normally.
- Before touching the connections of the High Force, Guard, and High Sense terminals, turn the instrument off and discharge any capacitors of the measurement path. If you do not turn the instrument off, complete “all” of the following items, regardless of any instrument’s settings.
 - Terminate source output by pressing the On/Off switch, confirm that the On/Off switch turns off.
 - Confirm that the HV (high voltage) status indicator is not lit.
 - Open the shielding box access door (open the Interlock terminal).
 - Discharge any capacitors if the capacitance is connected to this instrument.
- Warn workers in the vicinity of the instrument about hazardous conditions.



Gefahr durch Hochspannung

Von den Geräten Keysight B2900 können Spannungen an den Anschlüssen "High Force", "Guard" und "High Sense" von bis zu 210 V ausgehen. Um elektrischem Schlag vorzubeugen, ist bei der Benutzung der Geräte Keysight B2900 folgendes zu beachten.

- Verwenden Sie ein dreiphasiges AC-Stromkabel für die Gerätsteckvorrichtung (Eingang) und schließen Sie das Instrument an eine Erdung an (Sicherheitserdung).
- Bereiten Sie das Abschirmungsgehäuse vor, dass die Oberfläche eines zu testenden Geräts abdeckt und mit einem Verriegelungsstromkreis ausgestattet ist, der bei geöffneter Tür unterbrochen wird.
- Vor der Messung verbinden Sie den Verriegelungsstromkreis mit dem Interlock-Anschluss dieses Instruments.
- Prüfen Sie in regelmäßigen Abständen, dass die Verriegelungsfunktion ordnungsgemäß funktioniert.
- Bevor Sie die Verbindungen zu den Anschlüssen "High Force", "Guard" und "High Sense" berühren, schalten Sie das Instrument aus und entladen alle Kondensatoren des Messwegs. Wenn Sie das Instrument nicht ausschalten, führen Sie, unabhängig von den Instrumenteinstellungen, alle folgenden Schritte durch.
 - Beenden Sie die Messung, indem Sie auf die Taste "On/Off" drücken. Stellen Sie sicher, dass die Statusanzeige "On/Off" nicht leuchtet.
 - Stellen Sie sicher, dass die Anzeige "HV" nicht leuchtet.
 - Öffnen Sie die Tür des Abschirmungsgehäuses (öffnen des Interlock-Anschlusses).
 - Entladen Sie alle Kondensatoren, wenn die Kapazität mit das Instrument verbunden ist.
- Warnen Sie Mitarbeiter in der Umgebung des Instruments vor den Gefahren.



Danger de choc dû à une haute tension

Une tension dangereuse (max. \pm pour; 210 Vdc) émanant du dispositif Keysight B2900 peut être sortie aux bornes High Force, Guard et High Sense, d'appareil de protection ou de détection. Les précautions suivantes doivent être observées contre commotion électrique accidentelle.

- Utilisez un câble d'alimentation CA à trois conducteurs vers le coupleur secteur (entrée) et branchez l'instrument sur une mise électrique à la terre (prise de terre de sécurité).
- Préparez le boîtier de protection qui couvre l'interface avec le dispositif à tester et équipez-le d'un circuit de sécurité qui s'ouvre lors de l'ouverture d'une porte.
- Avant de procéder aux mesures, connectez le circuit de sécurité à la borne Interlock de l'instrument.
- Vérifiez régulièrement le bon fonctionnement de la fonction de sécurité.
- Avant de toucher les connexions des bornes High Force, Guard et High Sense, mettez l'instrument hors tension et déchargez tout condensateur du chemin de mesure. Si vous ne mettez pas l'instrument hors tension, effectuez « toutes » les opérations ci-dessous, quels que soient les paramètres de l'instrument.
 - Terminez les mesures en appuyant sur la touche On/Off ; vérifiez que l'indicateur d'état On/Off est éteint.
 - Vérifiez que le témoin HV est éteint.
 - Ouvrez la trappe d'accès au boîtier de protection (ouvrez la borne Interlock).
 - Déchargez les éventuels condensateurs si la capacité est connectée à l'instrument.
- Informez les personnes travaillant à proximité de l'instrument des conditions.



高電圧感電注意

Keysight B2900 の High Force、Guard、High Sense 端子には、危険電圧が出力されることがあります（最大 ± 210 Vdc）。感電事故防止のため、必ず以下の事柄を守ってください。

- 3 極電源ケーブルを使用して本器を接地してください。
- ドアを開くことによって開放されるインターロック回路を装備し、被測定デバイスとのインタフェースを覆うことのできるシールド・ボックスを用意してください。
- 測定を開始する前にはインターロック回路を本器の Interlock 端子に接続してください。
- インターロック機能が正常であることを定期的に確認してください。
- High Force、Guard、High Sense 端子に繋がる接続部に触れる前には、本器の電源を切断してください。また、測定系のキャパシタを放電してください。電源を切らない場合は、以下の事項を全て実施してください。
 - On/Off スイッチを押して On/Off スイッチが消灯したことを確認してください。
 - 高電圧警告インジケータ (HV) が消灯していることを確認してください。
 - シールド・ボックスのドアを開けてください (Interlock 端子を開放してください)。
 - 本器にキャパシタが接続されているならば、キャパシタを放電してください。
- 周囲のほかの作業者に対しても、高電圧危険に対する注意を徹底してください。

Product Stewardship



- Waste Electrical and Electronic Equipment (WEEE)

The crossed out wheeled bin symbol indicates that separate collection for waste electric and electronic equipment (WEEE) is required, as obligated by the EU DIRECTIVE and other National legislation.

Please refer to <http://keysight.com/go/takeback> to understand your Trade in options with Keysight in addition to product takeback instructions.

- LCD Fluorescent Lamp

Certain products sold by Keysight contain a liquid crystal display (LCD); backlighting for the LCD is provided by a fluorescent lamp which contains mercury, and must be managed, recycled, and/or disposed in accordance with all applicable laws, ordinances and regulations.

For information on how to recycle or dispose of the fluorescent lamp contained in your own product, visit the following website.

http://about.keysight.com/en/quality/env_compliance.shtml

If you live in the U.S., also visit the following websites.

<http://www.lamprecycle.org>

<http://www.eiae.org>

If you have additional questions, please visit the following website.

<http://www.keysight.com/go/contactus>

- Perchlorate Information

Perchlorate Material - special handling may apply. Visit the following website.

<http://www.dtsc.ca.gov/hazardouswaste/perchlorate/>

Equipment's real-time clock battery or coin cell battery may contain perchlorate and may require special handling when recycled or disposed of in California.

In This Manual

This manual describes the front panel operation, installation, and functions of the Keysight Technologies B2900 Precision Source/Measure Unit, SMU. This manual consists of the following chapters.

1. "Getting Started"

This chapter briefly explains how to use the Keysight B2900 by the front panel operation.

2. "Introduction"

This chapter describes overview, accessories, and options of the Keysight B2900.

3. "Installation"

This chapter explains how to install the Keysight B2900, and how to connect the device under test to a test fixture.

4. "Front Panel Reference"

This chapter provides the reference information of the Keysight B2900 front panel keys and graphical user interface.

5. "Front Panel Operations"

This chapter explains how to use the Keysight B2900 in the local mode.

6. "Function Details"

This chapter explains the several functions and initial settings of the Keysight B2900.

NOTE

For the specifications of the B2900, see Data Sheet.

To get the latest Data Sheet, go to www.keysight.com/find/b2900 and click "Technical Support" and "Specifications".

NOTE

The information is subject to change without notice due to the future enhancement.



The actual screen image on the B2900 may be different from the image shown in this manual.

Contents

1 Getting Started

Applying DC Output	27
Performing Spot Measurement	29
Performing Sweep Measurement	30
Operation Tips	32
Operation Summary	34

2 Introduction

Keysight B2900 Series	42
 Front View	43
 Rear View	47
Source/Measure Unit	49
Measurement Parameters	50
Limit/Compliance	50
Output and Measurement Ranges	51
Operation and Functions	59
Front Panel Interface	59
Source/Measurement Capabilities	61
Program and Interface Capabilities	62
Software and Drivers	64
Accessories	65
Furnished Accessories	65
Available Accessories	65
Options	66

3 Installation

	67
---	----

	68
⚠	Inspecting the Shipment	70
	Checking the Operation of Keysight B2900	70
	Checking for Errors	71
	Installing the Keysight B2900	72
	Safety Considerations	72
⚠	Environment	72
⚠	Connecting the Power Cord	73
	Setting the Power Line Frequency	76
	Setting Date and Time	76
	Bench Installation	76
	Rack Installation	77
	Maintenance	78
⚠	Cleaning	78
	Self-test	78
	Self-calibration	79
	Calibration	80
⚠	Connecting a DUT	81
	2-Wire Connections or 4-Wire Connections	82
⚠	Floating	83
	Using Test Leads	85
⚠	Using the N1295A Test Fixture	86
⚠	Using the 16442B Test Fixture	87
	Guarding	90
	Performing Low Current Measurements	90
⚠	Installing the Interlock Circuit	91
	Connecting to the Interfaces	94
	GPIB/USB Interfaces	94
	LAN Interface	96
	Communicating Over the LAN	98

Using the Graphical Web Interface98
Using Telnet99
Using Sockets99
Using Digital I/O	101
Accessory for Digital I/O Connector	103

4 Front Panel Reference

Hard Keys and Rotary Knob	106
Display and Assist Keys.	109
Dual View	110
Single View.	113
Graph View.	124
Roll View	126
Status Information	129
Function Keys	130
Config Key Group	132
Output Filter Dialog Box	133
Output Connection Dialog Box	134
Sweep Dialog Box	135
Ranging Dialog Box	136
Wait Control Dialog Box	137
Function Key Group.	138
Math Expression Dialog Box	138
Composite Limit Test Setup Dialog Box	139
Limit Test Setup Dialog Box	140
Trace Buffer Setup Dialog Box	141
Trigger Key Group	143
Trigger Configuration Dialog Box	144
Result Key Group	147

Measure Result Dialog Box	147
Limit Test Result Dialog Box	148
Trace Statistical Result Dialog Box	149
File Key Group	150
File Selection Dialog Box	150
Program Key Group	151
I/O Key Group	152
Data Output Format	153
Format (Measure) Dialog Box	154
Format (Math/Limit) Dialog Box	154
Format (Trace) Dialog Box	154
LAN Configuration Dialog Box	155
DIO Configuration Dialog Box	155
DIO Read/Write Dialog Box	156
Display Key Group	158
Display Preference Dialog Box	159
System Key Group	160

5 Front Panel Operations

Basic Operations	165
To Change the Setting in a Field	165
To Change the Settings on a Dialog Box	166
To Use Functions Other Than Measurement	167
To Set Power Line Frequency	168
To Return to Factory Shipment Condition	168
To Apply Initial Settings	168
To Set Beeper	168
To Set Date and Time	168
To Perform Self-Test	169

To Perform Self-Calibration	169
To Set Operations at Power On	169
To Display Error Message	169
To Clear Error Buffer	170
To Clear Timestamp	170
To Set Automatic Clear of Timestamp	170
To Display Firmware Revision	170
To Display License Information	170
To Set GPIB Address	171
To Set Remote Control Command Set	171
To Set Remote Display Mode	171
To Save/Recall All Setup Information	172
To Enable/Disable Media Transfer Protocol for Easy File Access	172
To Enable/Disable the Function to Restore the Trigger Mode Settings on the Local State	172
To Enable/Disable Source/Limit Real Time Update by Using Digit Pointer and Knob	173
To Set Source Output	174
To Set Source Output Mode	175
To Apply DC Voltage/Current	175
To Stop Source Output	175
To Set Limit (Compliance) Value	175
To Set Output Range	176
To Set Pulse Output	176
To Set Sweep Output	177
To Set List Sweep Output	178
To Set Source Output Trigger Parameters	179
To Set Source Wait Time	179
To Set Output Filter	180
To Set Connection Type	180
To Set Low Terminal State	180

To Enable or Disable High Capacitance Mode.	181
To Enable or Disable Over Voltage/Current Protection.	181
To Specify Output-Off Status	181
To Enable or Disable Automatic Output-On Function	182
To Enable or Disable Automatic Output-Off Function	182
To Set Ranging Mode of the Sweep Source.	183
To Set Sweep Direction	183
To Set Source Output Value after Sweep.	183
To Execute Measurement.	185
To Enable Resistance Measurement	185
To Set Measurement Mode.	186
To Perform Spot Measurement.	186
To Stop Measurement.	186
To Set Measurement Time	186
To Set Measurement Range	187
To Perform Sweep Measurement	187
To Set Measurement Trigger Parameters	188
To Set Measurement Wait Time	188
To Set Measurement Auto Range Operation	189
To Enable or Disable Resistance Compensation	189
To Use Math Function	191
To Execute Limit Test	192
To Set Composite Limit Test.	192
To Set Individual Limit Tests.	193
To Display Limit Test Result	195
To Use Trace Buffer	196
To Set Trace Buffer	196
To Display Statistical Data	197
To Use Program Memory	198
To Select a Program	198

To Control Program Operation	198
--	-----

6 Function Details

Limit/Compliance	200
To Set Compliance.	200
Ranging Mode	201
Setting the Ranging Mode.	201
Measurement Time	202
Aperture Time.	202
Overhead Time.	202
To Control Source/Measure Timing.	202
Pulse Output	204
To Control Pulse Output/Measure Timing.	204
To Set Pulse Output.	205
Sweep Output	206
To Set Sweep Output.	206
List Sweep	207
Output Filter	208
Over Voltage/Current Protection	209
Output-Off Status	210
Automatic Output-ON/OFF Function	211
High Capacitance Mode	212
Resistance Measurement	213
Resistance Compensation	213
Math Expression	214
Predefined Math Expressions.	214
Resources Used in the Expressions.	215

Limit Test	217
Trace Buffer	220
Program Memory	222
Channel Grouping	223
Trigger System	224
Trigger Source.....	227
Device Actions.....	227
Trigger Output.....	229
File Access Function (Easy File Access).....	230
 Interlock Function.....	231
Over Temperature Protection.....	232
Initial Settings	233

1 Getting Started

- Applying DC Output 27
- Performing Spot Measurement 29
- Performing Sweep Measurement 30
- Operation Tips 32
- Operation Summary 34

This chapter describes basic operations for Keysight B2900. Before learning the details of B2900, let us briefly cover the use of the B2900 source/measure unit. The operations require only B2900 and the power cord. To get started with the operations, open the measurement terminals.

NOTE

Turning B2900 on

1. Connect the power cord from the AC input connector (receptacle) on B2900's rear panel to an AC power outlet at your site.
2. Press the standby switch  on the front panel. When the power is on, the LED below the switch is turned green.

B2900 boots up and performs a self-test. After B2900 boots normally, the front panel LCD displays the following view. It will be the Single view for the 1-channel model or the Dual view for the 2-channel model.

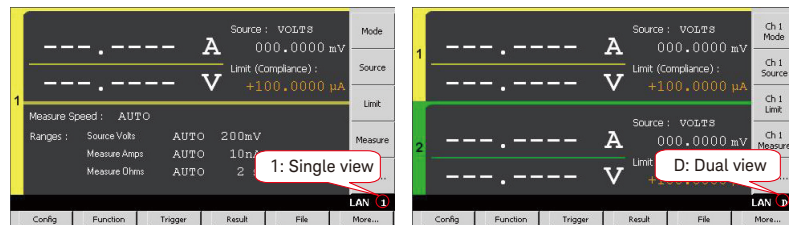

NOTE

Connecting your DUT

If you want to connect your device under test, see [“Connecting a DUT” on page 81](#).



Applying DC Output

B2900 can be used as a DC voltage or current source. The following procedure configures B2900 as a voltage source and applies a voltage of +500 mV.

Step 1. Setting the Source mode (voltage output)

1. Press the **Mode** assist key on a 1-ch model, or the **Ch1 Mode** assist key on a 2-ch model.

The field pointer appears on the Source mode, and the status changes to EDIT (green). The status information will show **EDIT**.

2. Press the **VOLTS (V)** assist key. Or use the rotary knob or arrow keys  and  to specify the mode, and press the knob to fix the setting.

The status changes to MOVE (blue). The status information will show **MOVE**.

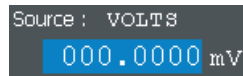

Source : VOLTS
000.0000 mV

Step 2. Setting the Source value (voltage output value)

1. Press the **Source** assist key on a 1-ch model, or the **Ch1 Source** assist key on a 2-ch model. Or, use the rotary knob or arrow keys to move the field pointer onto the Source value and press the knob. The field pointer appears on the Source value, and the status changes to EDIT (green).

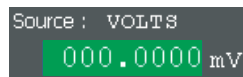

Source : VOLTS
000.0000 mV

2. Turn the rotary knob clockwise to increase the value, or counter clockwise to decrease the value. Set the desired value.

When you press an arrow key, a digit pointer will appear on a digit. Turning the knob will change the value of the digit, or move the decimal point if the pointer is on it.

3. Press the rotary knob to fix the value. The status changes to MOVE (blue).

Getting Started

Applying DC Output

The numeric/alpha keys and the unit assist keys are also available for setting the Source value in the same way as for setting the Limit value, shown in the next step.

This example sets the Source value to +500 mV.

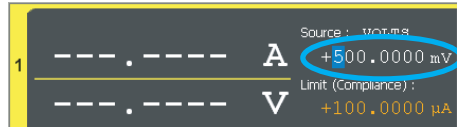

Step 3. Setting the Limit value (compliance current)

1. Press the **Limit** assist key on a 1-ch model, or the **Ch1 Limit** assist key on a 2-ch model. Or, use the rotary knob or arrow keys to move the field pointer onto the Limit value and press the knob. The field pointer appears on the Limit value, and the status changes to EDIT (green).



2. Use the rotary knob, arrow keys, or numeric/alpha keys to set the value.



3. Press one of the unit assist keys to set the unit and fix the value. The status changes to MOVE (blue).



This example sets the Limit value to 1 mA.

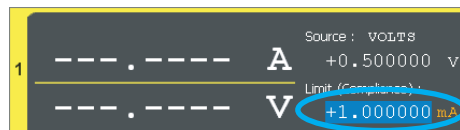

Step 4. Enabling the channel

Press the Ch 1  switch to enable channel 1. This turns the switch green. Channel 1 starts applying the voltage specified by the Source value.

Step 5. Disabling the channel

Press the Ch 1  switch to disable channel 1. This turns off the switch light.

Performing Spot Measurement

B2900 can be used as a DC voltage or current meter. The following procedure performs one point current measurement.

Step 1. Setting the measurement mode (current measurement)



Press the **Measure** assist key on a 1-ch model, or the **Ch1 Measure** assist key on a 2-ch model. And press the **AMPS (I)** assist key.

The rotary knob and arrow keys are also available for setting the measurement mode, in the same way as for setting the Source mode under “Applying DC Output”.

Step 2. Enabling the channel

Press the Ch 1  switch to enable channel 1. This turns the switch green. Channel 1 starts applying the voltage specified by the Source value.

Step 3. Starting measurement

- Press the  key to start a single (one shot) measurement. Spot measurement is performed once.
- Press the  key to start a repeat (continuous) measurement. Spot measurement is performed repeatedly.

The measurement results will be displayed in the left half of the LCD.

The following example shows the measurement results for a 1 k Ω resistor connected between the High Force and Low Force terminals of channel 1.

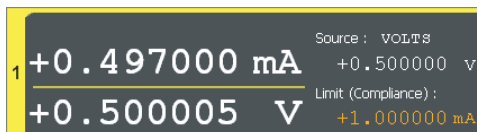

Step 4. Disabling the channel

Press the Ch 1  switch to disable channel 1. This turns off the switch light.

Performing Sweep Measurement

B2900 supports sweep measurements. The following example applies a staircase sweep voltage and measures the current at each step voltage.

Step 1. Press the **View** key to display the Single view.

Step 2. Set the Source mode, Limit value, and measurement mode as shown in “Applying DC Output” and “Performing Spot Measurement”.

This example sets the voltage output, a 10 mA limit value, and both current and voltage measurements.

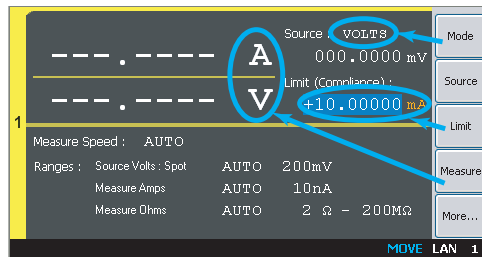

Step 3. Setting the Sweep parameters

1. Press the **More** assist key to change the assist keys.
2. Press the **Show Sweep** assist key to display the Sweep setup parameters.
3. Press the rotary knob to change the status to EDIT (green).
4. Press the **LINEAR SINGLE** assist key to set the linear single sweep mode.

The source shape indicator shows the staircase icon, and the status changes to MOVE (blue).

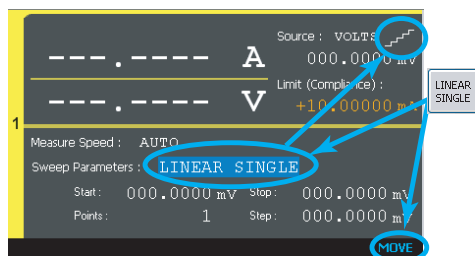

- Use the rotary knob, arrow keys, or numeric/alpha keys to set the Start (sweep start value), Stop (sweep stop value), and Step (sweep step value) or Points (number of sweep steps).

This example sets Start to 1 V, Stop to 2 V, and Points to 11.

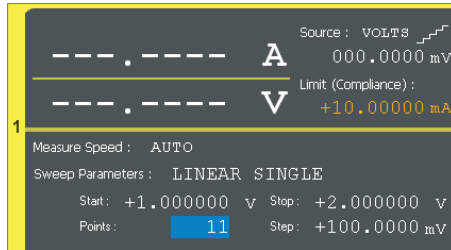

Step 4. Press the **View** key to display the Graph view.

Step 5. Enabling the channel

Press the Ch 1 **On/Off** switch to enable channel 1. This turns the switch green. Channel 1 starts applying the voltage specified by the Source value.

Step 6. Press the **Trigger** key to start a single (one shot) measurement. Sweep measurement is performed once. And the measurement results will be displayed on the graph.

Step 7. Press the **Auto Scale** assist key to fit the trace in the graph scale.

The following example shows the measurement results for a 1 k Ω resistor connected between the High Force and Low Force terminals of channel 1.

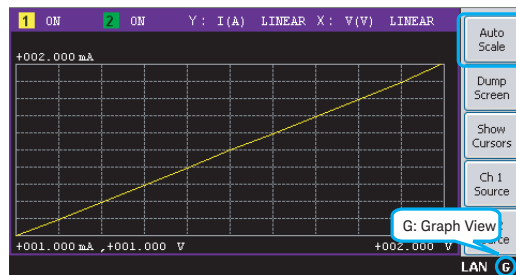

Step 8. Disabling the channel

Press the Ch 1 **On/Off** switch to disable channel 1. This turns off the switch light.

Operation Tips

This section introduces key operation and status information on B2900.

- “Changing the View Mode”
- “Editing the Setup”
- “Status Information”

Figure 1-1 Changing the View Mode

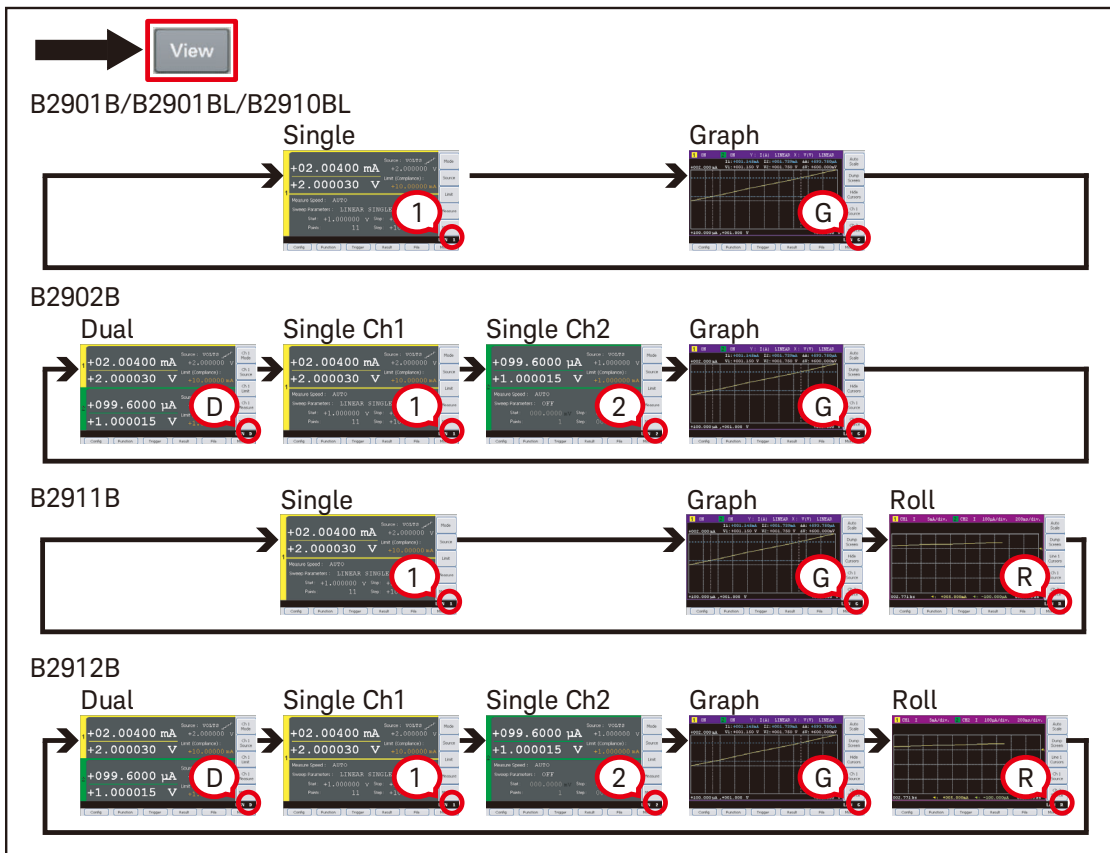

For details about the View mode, see “Display and Assist Keys” on page 109.

Figure 1-2 Editing the Setup

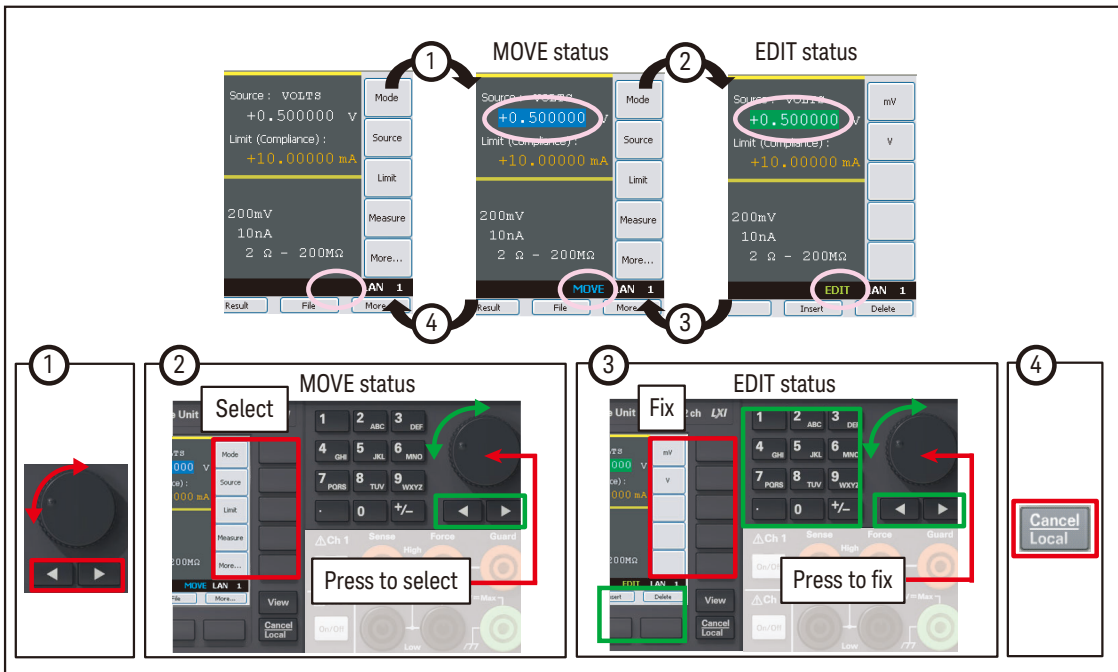

For more information about the front panel keys, see [“Hard Keys and Rotary Knob” on page 106](#).

If the field pointer is in the EDIT (green) status on the Source or Limit (Compliance) field, turning the knob changes the setting value of the source channel in real time.

Figure 1-3 Status Information

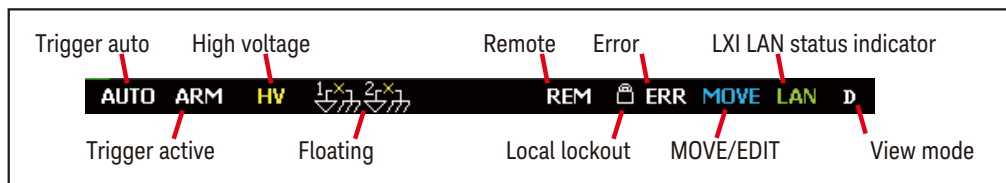

For details about the status information, see [“Status Information” on page 129](#).

Operation Summary

This section summarizes front panel operations on B2900.

- “Basic Operations”
- “Channel Setup”
- “Source Setup”
- “Measurement Setup”
- “Display Setup”
- “File Operations”
- “Miscellaneous Functions”
- “Interface Setup”
- “System Setup and Operations”

For details about front panel operations, see [Chapter 4, “Front Panel Reference.”](#)

Table 1-1 Basic Operations

Task	Relevant front panel key
To turn the B2900 on/off	Standby switch
To change the display mode	View key
To enable/disable the specified channel	Ch 1 On/Off switch or Ch 2 On/Off switch
To cancel the previous setup operation	Cancel/Local key
To return to the upper menu of a function key or softkey	Cancel/Local key
To return to the local status from the remote status	Cancel/Local key
To start a single (one shot) output/measurement	Trigger key
To start a repeat (continuous) measurement	Auto key
To move the field pointer	Rotary knob or arrow keys
To move the digit pointer	Rotary knob or arrow keys
To switch the EDIT/MOVE status	Rotary knob on a setup field
To select the setup value	Assist keys, rotary knob, or arrow keys
To save/recall all setup information of the B2900	Config > Save or Recall function keys

Table 1-2 Channel Setup

Task	Relevant front panel key
To enable/disable the specified channel	Ch 1 On/Off switch or Ch 2 On/Off switch
To select the sensing type: 2-wire or 4-wire	Config > Source > Connection function keys
To select the low terminal status; grounded or floating	Config > Source > Connection function keys
To enable/disable high capacitance mode	Config > Source > Connection function keys
To enable/disable over voltage/current protection	Config > Source > Connection function keys
To enable/disable resistance compensation	Config > Measure > R Compen function keys
To enable/disable 2-channel synchronous operation	Config > Common > Group function keys

Table 1-3 Source Setup

Task	Relevant front panel key
To enable/disable source output	Ch 1 On/Off switch or Ch 2 On/Off switch
To select source output mode	Mode, Ch1 Mode, or Ch2 Mode assist key
To set source output value	Source, Ch1 Source, or Ch2 Source assist key
To set limit/compliance value	Limit, Ch1 Limit, or Ch2 Limit assist key
To set constant source ranging mode	Speed assist key or Hide Sweep/Pulse/Trigger assist key on Single view
To set sweep source	Show Sweep assist key on Single view
To set list sweep source	Edit assist key in the EDIT status for the LIST sweep Start/Stop/Points field
To set sweep source ranging mode	Config > Source > Sweep function keys
To set sweep direction	Config > Source > Sweep function keys
To set source output value after sweep	Config > Source > Sweep function keys
To set pulse source	Show Pulse assist key on Single view
To set source wait time	Config > Common > Wait function keys
To set output filter	Config > Source > Filter function keys
To select output-off status	Config > Source > Connection function keys
To enable/disable automatic output ON	Config > Source > Connection function keys
To enable/disable automatic output OFF	Config > Source > Connection function keys

Table 1-4 Measurement Setup

Task	Relevant front panel key
To enable/disable the specified channel	Ch 1 On/Off switch or Ch 2 On/Off switch
To select measurement mode	Measure, Ch1 Measure, or Ch2 Measure assist key
To set measurement speed	Speed assist key on Single view

Task	Relevant front panel key
To set measurement ranging mode	Speed assist key or Hide Sweep/Pulse/Trigger assist key on Single view
To define automatic ranging operation	Config > Measure > Ranging function keys
To set measurement wait time	Config > Common > Wait function keys

Table 1-5 Display Setup

Task	Relevant front panel key
To change the display mode	View key
To change the color set	Display > Color function keys
To enable zoom-in	Display > Zoom > ON function keys
To disable zoom-in	Zoom Out assist key for the zoom-in display status
To change the data digits	Display > Digits function keys
To enable/disable the front panel display in the remote condition	Display > Remote function keys

Table 1-6 File Operations

Task	Relevant front panel key
To save a measurement result data to USB memory	File > Save > Measure function keys
To save a math result data to USB memory	File > Save > Math function keys
To save a limit test result data to USB memory	File > Save > Limit Test function keys
To save a trace buffer data to USB memory	File > Save > Trace function keys
To save a system setting data to USB memory	File > Save > Config function keys
To save a graph screen dump to USB memory	Dump Screen assist key on Graph or Roll view

Task	Relevant front panel key
To load a system setting data from USB memory	File > Load > Config function keys
To load a list sweep data from USB memory	Load assist key in the EDIT status for the LIST sweep Start/Stop/Points field

Table 1-7 Miscellaneous Functions

Task	Relevant front panel key
To enable/disable Limit (Compliance) for each polarity	Display > Pref. function keys
To enable/disable Source/Limit real time update by using digit pointer and knob	Display > Pref. function keys
To see measurement result	Result > Measure function keys
To use math expression	Function > Math function keys
To see math result	Result > Measure function keys
To set limit test	Function > Limit Test function keys
To see limit test result	Result > Limit Test function keys
To set trace buffer	Function > Trace function keys
To see trace statistical result	Result > Trace function keys
To select program memory	Program > Catalog function keys
To control program memory	Program > Control function keys
To set trigger parameters easily	Show Trigger assist key on Single view
To set trigger parameters in detail	Function > Trigger > Config function keys
To control trigger system	Function > Trigger > Initiate/Abort/Immediate function keys

Table 1-8 Interface Setup

Task	Relevant front panel key
To specify measurement data elements	I/O > Format > Measure function keys
To specify math and limit test data elements	I/O > Format > Math/Limit function keys
To specify trace statistical data elements	I/O > Format > Trace function keys
To select data output format	I/O > Format > Data Type function keys
To enable/disable byte swap of binary data	I/O > Format > Data Swap function keys
To set LAN configuration	I/O > LAN > Config function keys
To see status of LAN interface	I/O > LAN > Status function keys
To reset all of LAN connections	I/O > LAN > Reset function keys
To sets LAN settings to the default settings	I/O > LAN > Default function keys
To enable/disable Media Transfer Protocol for easy file access	I/O > USB function keys
To see status of USB interface	I/O > USB function keys
To set GPIB address	I/O > GPIB function keys
To see status of GPIB interface	I/O > GPIB function keys
To set configuration of Digital I/O	I/O > DIO > Config function keys
To read/write a value set to Digital I/O	I/O > DIO > R/W function keys

Table 1-9 System Setup and Operations

Task	Relevant front panel key
To set power line frequency	System > PLC function keys
To return to the factory shipment condition	System > More > Factory function keys
To apply initial settings	System > Reset function keys
To perform self-calibration	System > Cal/Test > Self-Cal function keys
To perform self-test	System > Cal/Test > Self-Test function keys

Getting Started
Operation Summary

Task	Relevant front panel key
To check errors	System > Error > Log function keys
To clear error log	System > Error > Clear function keys
To clear time stamp	System > Timestamp > Clear function keys
To set automatic clear of time stamp	System > Timestamp > Auto CLR function keys
To set start-up operation	System > More > Start-up function keys
To enable/disable beep and sound	System > More > Sound function keys
To select remote control command set	System > More > Language function keys
To enable/disable the function to restore the trigger mode settings on the local state	Display > Pref. function keys
To set date and time	System > More > Info. > Date/Time function keys
To perform firmware update	System > More > Info. > Update > Firmware function keys
To perform demonstration	System > More > Info. > Demo. function keys

2 Introduction

Keysight B2900 Series	42
Front View	43
Rear View	47
Source/Measure Unit	49
Operation and Functions	59
Software and Drivers	64
Accessories	65
Options	66

This chapter describes the basic functions and features of the Keysight B2900.

Keysight B2900 Series

Keysight B2900 is a series of precision SMU (source/measure unit, SMU). B2900 provides the LCD, front panel keys, and rotary knob for applying voltage/current or measuring voltage/current/resistance. B2900 also supports several functions, such as sweep output, pulse output, arbitrary waveform generation, limit test, trace buffer, math expressions, and graph plot. Hence, B2900 can be used as a DC (constant) voltage/current source, sweep voltage/current source, pulse generator, arbitrary waveform generator, and multimeter.

The product lineup of the Keysight B2900 series includes the following products.

Table 2-1 **Keysight B2900 Series**

Model No.	Number of SMU channels	Effective set and measure value			
		Minimum resolution		Maximum current	Maximum voltage
		Set	Measure		
B2901BL	1	1 pA, 1 μ V	1 pA, 0.1 μ V	DC: \pm 1.5A	\pm 21 V
B2910BL	1	0.1 pA, 1 μ V	0.01 pA, 0.1 μ V		\pm 210 V
B2901B	1	1 pA, 1 μ V	0.1 pA, 0.1 μ V	DC: \pm 3.03 A Pulse: \pm 10.5 A	
B2902B	2				
B2911B	1	0.01 pA, 0.1 μ V			
B2912B	2				

B2900 is a LAN eXtended Interface Core compliant instrument.

Front View

This section describes the front view of the Keysight B2900 series.



- Standby switch
Turns the instrument on or off. When the power is on, the LED below the switch is turned green.
- Display
Displays the source setup, measurement result, status information, etc. For details, see [Chapter 4, "Front Panel Reference."](#)
- Trigger key
Starts a single (one shot) output/measurement or initiates trigger system. If a repeat measurement is in progress, stops it.

The single measurement is performed with the DC bias output, staircase sweep output, pulsed bias output, or pulsed sweep output set to the channel. One single measurement can contain the maximum of 100000 measurement points.

Once a single measurement starts, the data buffer (maximum 100000 data) is cleared, and the last single measurement result is stored in the buffer. The measurement result is displayed on the Single view, Dual view, Graph view, or Roll view.

NOTE

If measurement is not performed properly, check the trigger setting. The trigger type must be set to AUTO, or the trigger count (Count) must be set properly. See [“Trigger parameters” on page 122](#).

- Auto key
Starts a repeat (continuous) measurement. If a repeat measurement is in progress, stops it.
The repeat measurement is performed with the DC bias output of the Source value. And the measurement result is displayed on the Single view, Dual view, or Roll view. The repeat measurement result is not stored in the buffer.
- USB-A connector
Used to connect a USB memory. After disconnecting the USB memory, wait 10 seconds before connecting it again or new one.

CAUTION

Turning the instrument off while the USB memory is being accessed may damage the device.

- Function keys
Six function keys are available below the display. They are assigned to the softkeys, Config, Function, Trigger, Result, File, Program, I/O, System, and More. For details, see [Chapter 4, “Front Panel Reference.”](#)
- Assist keys
Five assist keys are available to the right of the display. They are assigned to several softkeys, such as Mode, Source, Limit, Measure, and More. The softkey assignment depends on the display mode (Single, Graph, Roll, or Dual). For details, see [Chapter 4, “Front Panel Reference.”](#)
- View key
Changes the display mode. Pressing the key changes the mode as shown below.
 - B2901B, B2901BL, and B2910BL
Single → Graph → (return to Single)
 - B2902B

Dual → Single for channel 1 → Single for channel 2 → Graph → (return to Dual)

- B2911B

Single → Graph → Roll → (return to Single)

- B2912B

Dual → Single for channel 1 → Single for channel 2 → Graph → Roll → (return to Dual)

- Cancel/Local key

Cancels the setup operation if the instrument is in the local status. Returns the instrument to the local status if it is in the remote status.

- Numeric/alpha keys

Used to enter the value of setup parameters such as the source output value, limit (compliance) value, and message, specified by the field pointer.

- Rotary knob

If the field pointer is in the MOVE (blue) status, turning the knob moves the pointer. Pressing the knob fixes the pointer position and changes the pointer status to EDIT (green).

If the field pointer is in the EDIT (green) status, turning the knob changes the value of the setup parameter specified by the pointer. Pressing the knob fixes the value and changes the pointer status to MOVE (blue).

- Left and right keys

If the field pointer is in the MOVE (blue) status, pressing the key moves the pointer.

If the field pointer is in the EDIT (green) status, pressing the key changes the value of the setup parameter specified by the pointer.

If the field pointer is in the EDIT (green) status on a numeric value entry field, pressing the key changes the pointer to a digit pointer.



- On/Off switch(es)

Used to enable or disable the SMU channel. Turns the channel off if it is in the output status even if it is in the remote status. One switch on 1-channel models, and two switches on 2-channel models.

The switch turns green if the channel is enabled.

The switch turns red if the channel is in the high voltage state.



- Channel 1 source/measure terminals

Terminals for SMU channel 1. High Force, Low Force, High Sense, Low Sense, Guard, and chassis ground. For details, see [“Connecting a DUT” on page 81](#).

CAUTION

Never connect the Guard terminal to any output, including circuit common, chassis ground, or any other guard terminal. Doing so will damage the B2900.

CAUTION

Do not apply current to the chassis ground terminal. Doing so will damage the B2900.

Rear View

This section describes the rear view of the Keysight B2900 series.

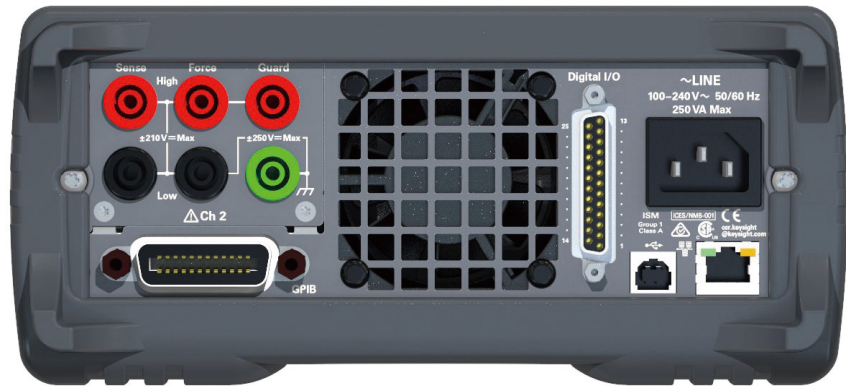

- Channel 2 source/measure terminals

Only on 2-channel models. Terminals for SMU channel 2. High Force, Low Force, High Sense, Low Sense, Guard, and chassis ground. For details, see [“Connecting a DUT” on page 81](#).

CAUTION

Never connect the Guard terminal to any output, including circuit common, chassis ground, or any other guard terminal. Doing so will damage the B2900.

CAUTION

Do not apply current to the chassis ground terminal. Doing so will damage the B2900.

- GPIB interface connector
Use a Keysight 82357A/B USB/GPIB interface or Keysight 10833A/B/C/D GPIB cable to connect to an external computer or equipment.
- Cooling fan
- AC input connector
AC power cord is connected to this receptacle.

- LAN interface connector
Connects to 10/100 Base-T interface. Left LED indicates activity. Right LED indicates link integrity.
- USB-B connector
Connects to USB interface.
- Digital I/O connector
D-sub 25 pin female connector for general purpose I/O (GPIO). Can be used as trigger input/output terminals or as an interface to a handler or the likes. For details, see [“Using Digital I/O” on page 101](#).

Pins 16 and 24 and pins 17 and 25 are reserved for the interlock function. If the terminals are open, the instrument output is limited to ± 42 V. Be sure to connect the terminals to the Keysight 16442B test fixture or another DUT interface before performing measurements. If you do not use 16442B, you need to install an interlock circuit. For details on how to install the interlock circuit, see [“Installing the Interlock Circuit” on page 91](#).

WARNING

Dangerous voltage, instrument maximum output voltage may appear at the High Force, High Sense, and Guard terminals if the Interlock terminal is closed.

Une tension dangereuse, une tension de sortie maximale de l'appareil peut apparaître aux bornes High Force, High Sense et Guard si la borne Interlock est fermée.

NOTE**Serial Number**

You will need the instrument's *serial number* when using the Keysight Technologies telephone assistance program. The serial number label is attached to the bottom of the instrument.

Source/Measure Unit

The source/measure unit (SMU) can apply voltage or current, and can measure current or voltage.

Figure 2-1 shows a simplified SMU circuit diagrams. The SMU can perform the following operations.

- Applies voltage and measures current
- Applies current and measures voltage
- Applies voltage and measures voltage
- Applies current and measures current

Figure 2-1 Simplified SMU Circuit Diagram

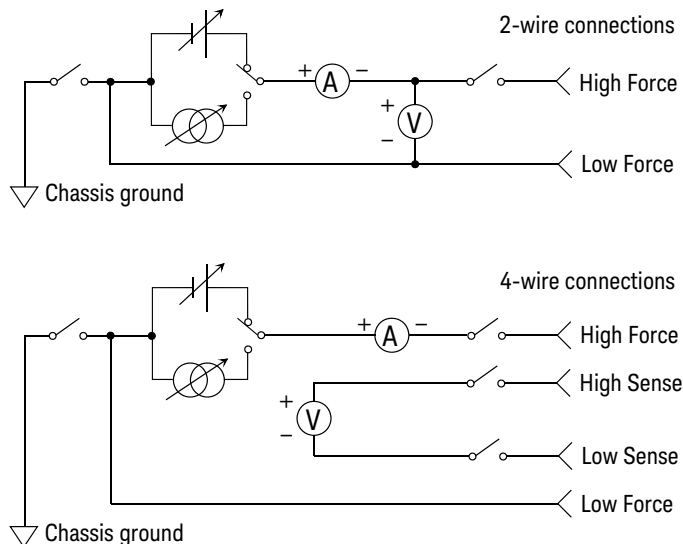

Measurement Parameters

B2900 supports the following measurement parameters.

- Current
- Voltage
- Resistance
- Power

Resistance data is given by $\text{Resistance} = V_{\text{meas}}/I_{\text{meas}}$.

Power data is given by $\text{Power} = V_{\text{meas}} \times I_{\text{meas}}$.

In the above formula, V_{meas} is the voltage measurement data, and I_{meas} is the current measurement data.

For using the resistance compensation, see [“Resistance Compensation” on page 213](#).

Limit/Compliance

B2900 has a compliance feature that limits the output voltage or current to prevent damage to the device under test. When the SMU applies voltage, you can specify the current limit/compliance. When the SMU applies current, you can specify the voltage limit/compliance. For details about limit/compliance, see [“Limit/Compliance” on page 200](#).

Output and Measurement Ranges

This section describes typical specifications of the Keysight B2900 series.

- Maximum voltage and current: see [Figures 2-2](#) and [2-3](#).
- Maximum power: 31.8 W
- Output/measurement value and resolution: see [Tables 2-2](#) to [2-9](#).

Figure 2-2 Maximum Voltage and Current (B2901B, B2902B, B2911B, and B2912B)

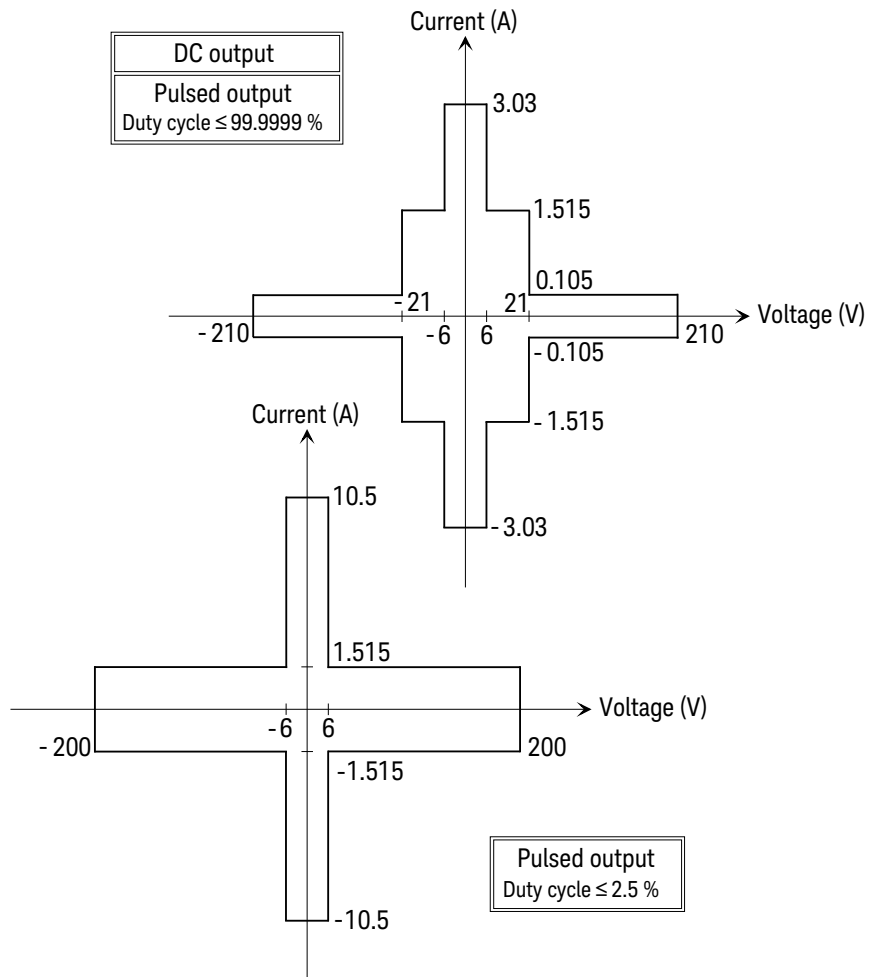

Figure 2-3 Maximum Voltage and Current (B2901BL and B2910BL)

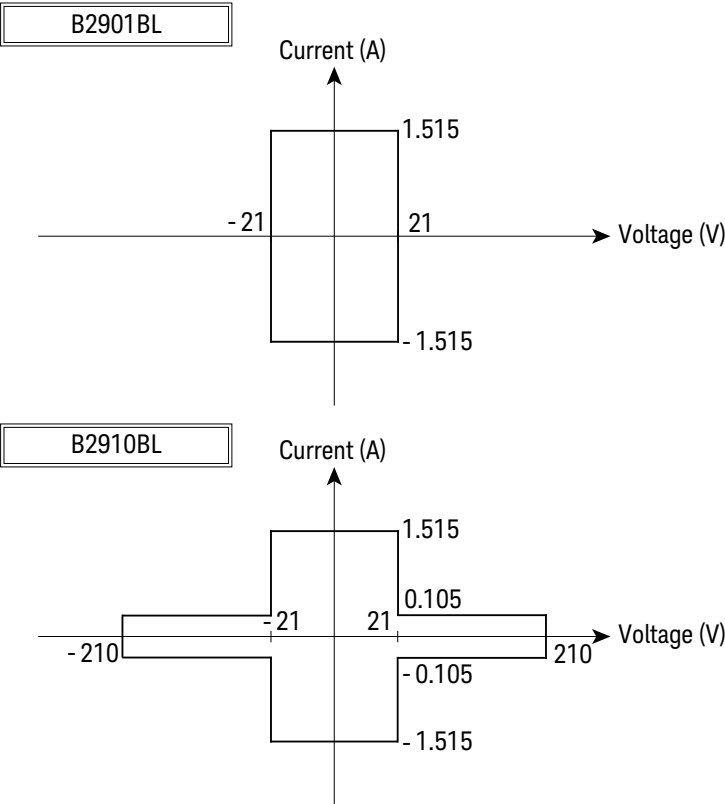

Table 2-2 Current Output Range (B2901B, B2902B, B2911B, and B2912B)

Range value	Setting resolution		DC output current or pulse peak/base current ^{a b}	Maximum voltage		Pulse width t ^c
	B2901B B2902B	B2911B B2912B		DC output	Pulsed output	
10 nA ^d	–	10 fA	$0 \leq \leq 10.5 \text{ nA}$	$\pm 210 \text{ V}$	$\pm 210 \text{ V}$	$50 \mu\text{s} \leq t \leq t_{\text{max}}$
100 nA	1 pA	100 fA	$0 \leq \leq 105 \text{ nA}$			
1 μA	10 pA	1 pA	$0 \leq \leq 1.05 \mu\text{A}$			
10 μA	100 pA	10 pA	$0 \leq \leq 10.5 \mu\text{A}$			
100 μA	1 nA	100 pA	$0 \leq \leq 105 \mu\text{A}$			
1 mA	10 nA	1 nA	$0 \leq \leq 1.05 \text{ mA}$			
10 mA	100 nA	10 nA	$0 \leq \leq 10.5 \text{ mA}$			
100 mA	1 μA	100 nA	$0 \leq \leq 105 \text{ mA}$			
1 A	10 μA	1 μA	$0 \leq \leq 105 \text{ mA}$			
			$105 \text{ mA} < \leq 1.05 \text{ A}$	$\pm 21 \text{ V}$	$\pm 21 \text{ V}$	
			$0 \leq \leq 1.05 \text{ A}$	–	$\pm 200 \text{ V}$	$50 \mu\text{s} \leq t \leq 2.5 \text{ ms}$
1.5 A			$0 \leq \leq 105 \text{ mA}$	$\pm 210 \text{ V}$	$\pm 210 \text{ V}$	$50 \mu\text{s} \leq t \leq t_{\text{max}}$
			$105 \text{ mA} < \leq 1.515 \text{ A}$	$\pm 21 \text{ V}$	$\pm 21 \text{ V}$	
			$0 \leq \leq 1.515 \text{ A}$	–	$\pm 200 \text{ V}$	$50 \mu\text{s} \leq t \leq 2.5 \text{ ms}$
			$0 \leq \leq 1.05 \text{ A}$	–	$\pm 180 \text{ V}$	$50 \mu\text{s} \leq t \leq 10 \text{ ms}$
3 A	100 μA	10 μA	$0 \leq \leq 105 \text{ mA}$	$\pm 210 \text{ V}$	$\pm 210 \text{ V}$	$50 \mu\text{s} \leq t \leq t_{\text{max}}$
			$105 \text{ mA} < \leq 1.515 \text{ A}$	$\pm 21 \text{ V}$	$\pm 21 \text{ V}$	
			$1.515 \text{ A} < \leq 3.03 \text{ A}$	$\pm 6 \text{ V}$	$\pm 6 \text{ V}$	
10 A			$0 \leq \leq 10.5 \text{ A}$	–	$\pm 6 \text{ V}$	$50 \mu\text{s} \leq t \leq 1 \text{ ms}$
			$0 \leq \leq 1.515 \text{ A}$	–	$\pm 200 \text{ V}$	$50 \mu\text{s} \leq t \leq 2.5 \text{ ms}$
			$0 \leq \leq 1.05 \text{ A}$	–	$\pm 180 \text{ V}$	$50 \mu\text{s} \leq t \leq 10 \text{ ms}$

Introduction
Source/Measure Unit

- a. Table 2-6 shows the limitations when using Channels 1 and 2 for DC output or Pulsed output with $50 \mu\text{s} \leq t \leq t_{\text{max}}$ ($=99.9999 \text{ ks}$).
 b. Maximum base current is 500 mA for the pulse with $50 \mu\text{s} \leq t \leq 1 \text{ ms}$, and 50 mA for the pulse with $50 \mu\text{s} \leq t \leq 2.5 \text{ ms}$ or $50 \mu\text{s} \leq t \leq 10 \text{ ms}$.
 c. Maximum duty cycle is 99.9999 % for the pulse with $50 \mu\text{s} \leq t \leq t_{\text{max}}$, and 2.5 % for the pulse with $50 \mu\text{s} \leq t \leq 1 \text{ ms}$, $50 \mu\text{s} \leq t \leq 2.5 \text{ ms}$, or $50 \mu\text{s} \leq t \leq 10 \text{ ms}$.
 d. Available for B2911B and B2912B. Not available for B2901B and B2902B.

Table 2-3 Current Output Range (B2901BL and B2910BL)

Range value	Setting resolution		DC output current	Maximum voltage	
	B2901BL	B2910BL		B2901BL	B2910BL
10 nA ^a	–	100 fA	$0 \leq \leq 10.5 \text{ nA}$	–	$\pm 210 \text{ V}$
100 nA ^a	–	1 nA	$0 \leq \leq 105 \text{ nA}$	–	
1 μA	10 pA	10 pA	$0 \leq \leq 1.05 \mu\text{A}$	$\pm 21 \text{ V}$	
10 μA	100 pA	100 pA	$0 \leq \leq 10.5 \mu\text{A}$		
100 μA	1 nA	1 nA	$0 \leq \leq 105 \mu\text{A}$		
1 mA	10 nA	10 nA	$0 \leq \leq 1.05 \text{ mA}$		
10 mA	100 nA	100 nA	$0 \leq \leq 10.5 \text{ mA}$		
100 mA	1 μA	1 μA	$0 \leq \leq 105 \text{ mA}$		
1 A	10 μA	10 μA	$0 \leq \leq 105 \text{ mA}$		
			$105 \text{ mA} < \leq 1.05 \text{ A}$		$\pm 21 \text{ V}$
1.5 A			$0 \leq \leq 105 \text{ mA}$		$\pm 210 \text{ V}$
			$105 \text{ mA} < \leq 1.515 \text{ A}$		$\pm 21 \text{ V}$

a. Available for B2910BL. Not available for B2901BL.

Table 2-4 Voltage Output Range (B2901B, B2902B, B2911B, and B2912B)

Range value	Setting resolution		DC output voltage or pulse peak/base voltage	Maximum current ^a		Pulse width t ^b
	B2901B B2902B	B2911B B2912B		DC output	Pulsed output	
0.2 V	1 μ V	0.1 μ V	$0 \leq V \leq 0.21$ V	± 3.03 A	± 3.03 A with $50 \mu\text{s} \leq t \leq t_{\text{max}}$	
2 V	10 μ V	1 μ V	$0 \leq V \leq 2.1$ V		± 10.5 A with $50 \mu\text{s} \leq t \leq 1$ ms	
20 V	100 μ V	10 μ V	$0 \leq V \leq 6$ V			
			$6 \text{ V} < V \leq 21$ V	± 1.515 A	± 1.515 A with $50 \mu\text{s} \leq t \leq t_{\text{max}}$	
200 V	1 mV	100 μ V	$0 \leq V \leq 6$ V	± 3.03 A	± 3.03 A with $50 \mu\text{s} \leq t \leq t_{\text{max}}$	
					± 10.5 A with $50 \mu\text{s} \leq t \leq 1$ ms	
			$6 \text{ V} < V \leq 21$ V	± 1.515 A	± 1.515 A	$50 \mu\text{s} \leq t \leq t_{\text{max}}$
			$21 \text{ V} < V \leq 210$ V	± 105 mA	± 105 mA	
			$0 \leq V \leq 180$ V	–	± 1.05 A	$50 \mu\text{s} \leq t \leq 10$ ms
			$0 \leq V \leq 200$ V	–	± 1.515 A	$50 \mu\text{s} \leq t \leq 2.5$ ms

a. Table 2-6 shows the limitations when using Channels 1 and 2 for DC output or Pulsed output with $50 \mu\text{s} \leq t \leq t_{\text{max}}$ (=99.9999 ks).

b. Maximum duty cycle is 99.9999 % for the pulse with $50 \mu\text{s} \leq t \leq t_{\text{max}}$, and 2.5 % for the pulse with $50 \mu\text{s} \leq t \leq 1$ ms, $50 \mu\text{s} \leq t \leq 2.5$ ms, or $50 \mu\text{s} \leq t \leq 10$ ms.

Table 2-5 Voltage Output Range (B2901BL and B2910BL)

Range value	Setting resolution		DC output voltage or pulse peak/base voltage	Maximum current	
	B2901BL	B2910BL		B2901BL	B2910BL
0.2 V	1 μ V	1 μ V	$0 \leq V \leq 0.21$ V	± 1.515 A	± 1.515 A
2 V	10 μ V	10 μ V	$0 \leq V \leq 2.1$ V		
20 V	100 μ V	100 μ V	$0 \leq V \leq 6$ V 6 V < $ V \leq 21$ V		
200 V ^a	–	1 mV	$0 \leq V \leq 6$ V 6 V < $ V \leq 21$ V 21 V < $ V \leq 210$ V	–	± 105 mA

a. Available for B2910BL. Not available for B2901BL.

Table 2-6 Limitations for using Channels 1 and 2

Channel 1 voltage V1	Channel 2 voltage V2	Current limit ^a
$0 < V1 \leq 6$ V	$0 < V2 \leq 6$ V	$I1 + I2 \leq 4$ A
	6 V < $ V2 \leq 21$ V	$I1 + I2 \times 1.6 \leq 4$ A
6 V < $ V1 \leq 21$ V	$0 < V2 \leq 6$ V	$I1 + I2 \times 0.625 \leq 2.5$ A
	6 V < $ V2 \leq 21$ V	$I1 + I2 \leq 2.5$ A

a. I1: Channel 1 current, I2: Channel 2 current

Table 2-7

Current Measurement Range

Range value	Current measurement value	Resolution
10 nA ^a	$0 \leq \leq 10.6 \text{ nA}$	10 fA
100 nA ^b	$0 \leq \leq 106 \text{ nA}$	100 fA
1 μA	$0 \leq \leq 1.06 \mu\text{A}$	1 pA
10 μA	$0 \leq \leq 10.6 \mu\text{A}$	10 pA
100 μA	$0 \leq \leq 106 \mu\text{A}$	100 pA
1 mA	$0 \leq \leq 1.06 \text{ mA}$	1 nA
10 mA	$0 \leq \leq 10.6 \text{ mA}$	10 nA
100 mA	$0 \leq \leq 106 \text{ mA}$	100 nA
1 A	$0 \leq \leq 1.06 \text{ A}$	1 μA
1.5 A	$0 \leq \leq 1.53 \text{ A}$	
3 A ^c	$0 \leq \leq 3.06 \text{ A}$	10 μA
10 A ^{b d}	$0 \leq \leq 10.6 \text{ A}$	

a. Available for B2910BL, B2911B, and B2912B. Not available for B2901BL, B2901B and B2902B.

b. Available for B2901B, B2902B, B2911B, B2912B, and B2910BL. Not Available for B2901BL.

c. Available for B2901B, B2902B, B2911B, and B2912B. Not available for B2901BL and B2910BL.

d. Available for pulse mode. Not available for DC mode.

Table 2-8 Voltage Measurement Range

Range value	Voltage measurement value	Resolution
0.2 V	$0 \leq V \leq 0.212 \text{ V}$	0.1 μV
2 V	$0 \leq V \leq 2.12 \text{ V}$	1 μV
20 V	$0 \leq V \leq 21.2 \text{ V}$	10 μV
200 V ^a	$0 \leq V \leq 212 \text{ V}$	100 μV

a. Available for B2910BL, B2901B, B2902B, B2911B, and B2912B. Not available for B2901BL.

Table 2-9 Resistance Measurement Range¹

Range value	Resistance measurement value	Display resolution	Test current
2 Ω	$0 < R \leq 2 \Omega$	1 $\mu\Omega$	1 A
20 Ω	$2 \Omega < R \leq 20 \Omega$	10 $\mu\Omega$	100 mA
200 Ω	$20 \Omega < R \leq 200 \Omega$	100 $\mu\Omega$	10 mA
2 k Ω	$200 \Omega < R \leq 2 \text{ k}\Omega$	1 m Ω	1 mA
20 k Ω	$2 \text{ k}\Omega < R \leq 20 \text{ k}\Omega$	10 m Ω	100 μA
200 k Ω	$20 \text{ k}\Omega < R \leq 200 \text{ k}\Omega$	100 m Ω	10 μA
2 M Ω	$200 \text{ k}\Omega < R \leq 2 \text{ M}\Omega$	1 Ω	1 μA
20 M Ω ^a	$2 \text{ M}\Omega < R \leq 20 \text{ M}\Omega$	10 Ω	100 nA
200 M Ω ^a	$20 \text{ M}\Omega < R \leq 200 \text{ M}\Omega$	100 Ω	10 nA

a. Available for B2910BL, B2901B, B2902B, B2911B, and B2912B. Not available for B2901BL.

1. The resistance measurement range is effective for the resistance measurements set to the AUTO mode which is selected by the :SENS:RES:MODE command.

Operation and Functions

Front Panel Interface

4.3 inch color TFT WQVGA (480x272, with LED backlight) provides a graphical user interface (GUI) with the following features.

- 4-view modes (Single, Dual, Graph, Roll view)
- Easy-to-use key operations
- Easy access to basic and advanced source/measurement capabilities

Single view

Single view provides basic and advanced settings and display capabilities for the selected channel from the front panel of the instrument. No additional controller or software is required.

Dual view

Dual view provides the basic settings and display capabilities for both channels 1 and 2. Up to 6½ digits can be displayed in the Dual view mode. This mode is available only for the B2902B and B2912B.

Graph view

Graph view displays measurement results on XY graphs (such as I-V and I-t/V-t curves) on up to 2 channels. This is useful for quick evaluation of device characteristics, especially those obtained from sweep measurements.

Roll view

Roll view draws I-t or V-t curves similar to the curves drawn by a strip chart recorder. Up to 1000 acquired data points can be displayed and updated while the measurement is still in progress. Roll view's continuous measurement capability is especially useful for monitoring low frequency phenomena. Roll view is available only for the B2911B and B2912B.

Easy-to-Use Key Operations

- Numeric/alpha keys, assist keys, and rotary knob for easy operation
- Numeric/alpha keys enable direct input of alphanumeric values.
- Assist key guides operation on the front panel.

Easy Access to Source/Masurement Capabilities

- Settings:
 - V/I source mode
 - Source value
 - Limit (Compliance) value
 - Sweep parameters
 - Pulse parameters
 - Measure speed
 - Range setting
 - Trigger setting
- Result Displays:
 - Numeric results fully up to 6½ digits both in Single and Dual view modes
 - Characterization in Graph view and Roll view
 - Data list
- Advanced Capabilities:
 - Limit testing by user definable limits working with component handlers
 - Trace memory for accumulating measurement (or math) result and collecting their statistics
- File Operations (USB memory):
Save:
 - System configuration
 - Measurement/Math result
 - Limit test result

- Trace data
- Graph screen dump

Load:

- System configuration
- List sweep data

Source/Measurement Capabilities

Sweep Measurement

- Number of sweep steps:
B2901BL: 1 to 10000
B2910BL, B2901B, B2902B, B2911B, and B2912B: 1 to 100000
- Sweep mode: linear, logarithmic (log), or list
- Sweep direction: single or double
- Type:
B2901BL and B2910BL: DC
B2901B, B2902B, B2911B, and B2912B: DC or pulse
- Minimum programmable value to create list sweep waveform:
B2901BL: 200 μs with 1 μs resolution
B2910BL: 50 μs with 1 μs resolution
B2901B and B2902B: 20 μs with 1 μs resolution
B2911B and B2912B: 10 μs with 1 μs resolution

Digitizing/Sampling Measurement

Digitizing or sampling measurement can be performed by appropriate setting of measure speed and trigger interval.

Minimum trigger interval (maximum speed of measurement):

B2901BL: 200 μs (5000 points/s)

B2910BL: 50 μs (20000 points/s)

B2901B and B2902B: 20 μs (50000 points/s)

B2911B and B2912B: 10 μ s (100000 points/s)

Data Buffers

Data buffers are array of measurement elements. Each elements hold the following values.

- Measured voltage
- Measured current
- Measured resistance
- Time stamp
- Measurement status
- Source setting

Maximum buffer size:

B2901BL: 10000 points/channel

B2910BL, B2901B, B2902B, B2911B, and B2912B: 100000 points/channel

Program and Interface Capabilities

Programming Language

The B2900 supports SCPI (Standard Commands for Programmable Instruments).

- Default command set: Supports all of the advanced features of the B2900.
- Conventional command set: Supports industry standard conventional SCPI command set for basic compatibility.

Program Memory

Program memory allows you to store long strings of SCPI command lines once into the built-in volatile memory and then recall those strings multiple times while the program is executing using a single SCPI command. By storing the command strings in memory, the time that would have been spent sending those same commands over a communication bus is eliminated. For tests that utilize lots of repeated code (such as subroutines), program memory can dramatically reduce test times.

- Maximum number of characters of program name: 32 with alphabets, numbers, hyphens, and underscores
- Maximum memory size: 100 KB (2500 lines typical)

LXI

LXI core conformant. The B2900 follows specified LAN protocols and adhere to LXI requirements such as a built-in Web control server and IVI-COM driver.

- Ethernet: 10/100Base-T
- USB2.0: USB-TMC488 protocol (rear × 1)
- GPIB: IEEE-488.2 compliant

USB File System

USB 2.0 high-speed mass storage (MSC) class device (front × 1)

Digital I/O Interface

- Connector: 25-pin female D
- Input/output pins: 14 open drain I/O bits
- Absolute maximum input voltage: 5.25 V
- Absolute minimum input voltage: -0.25 V
- Logic low maximum input voltage: 0.8 V
- Logic high minimum input voltage: 2.0 V
- Maximum source current: 1 mA, $V_{out} = 0$ V
- Maximum sink current: 50 mA, $V_{out} = 5$ V
- 5 V power supply pin:
Limited to 600 mA, solid state fuse protected
- Safety interlock pin:
One active high pin and one active low pin. Activation of both pin enables output voltage > 42 V.

Software and Drivers

- Graphical Web Interface

The Graphical Web Interface is a web browser based instrument control panel. It enables you to set up and perform a measurement easily and quickly from a web browser using the built-in web server. This allows you to control one B2900 over a LAN connection.

- IVI-C or IVI-COM drivers

Compatible with Windows 8 (64 bit/32 bit), 10 (64 bit/32 bit) IO Libraries 17.0 or later. Supports Keysight VEE, Microsoft Visual Studio (Visual Basic, Visual C++, Visual C#), National Instruments LabWindows and LabVIEW.

- LabVIEW driver (VI)

National Instruments LabVIEW 8.5/2010 or later. LabVIEW drivers are available at NI.COM.

NOTE

For the latest system requirements, go to www.keysight.com/find/b2900 and get the information.

Accessories

Furnished Accessories

The Keysight B2900B/BL is furnished with the following accessories.

- Quick Startup Poster, 1 ea.
- Quick Reference, 1 ea.
- License-to-use for EasyEXPERT
- Power cord, 1 ea.
- USB cable, 1 ea.

Available Accessories

For the available accessories for the Keysight B2900 series, see the catalog *Accessories for the B2900 Precision Instrument Family*.

To get the latest catalog, go to www.keysight.com/find/b2900.

Options

Table 2-10 lists the options for the Keysight B2900.

Table 2-10

Options

Option	Description
1A7	Calibration, uncertainties, and guardbanding (not accredited)
A6J	ANSI Z540 compliant calibration
UK6	Commercial calibration certificate with test data

3 Installation

Inspecting the Shipment	70
Installing the Keysight B2900	72
Maintenance	78
Connecting a DUT	81
Installing the Interlock Circuit	91
Connecting to the Interfaces	94
Communicating Over the LAN	98
Using Digital I/O	101

This chapter describes how to install Keysight B2900 and accessories.

WARNING

To avoid electrical shock and instrument damage, turn the instrument off before connecting or disconnecting measurement cable.



Mettez la machine hors tension pour fixer le connecteur ou pour retirer le connecteur de l'unité centrale.

WARNING



There are potentially hazardous voltages (± 210 V) present at the High Force, High Sense, and Guard terminals of this instrument. To prevent electrical shock, the following safety precautions must be observed during the use of the instrument.

- Use a three-conductor AC power cord to connect the cabinet (if used) and the instrument to an electrical ground (safety ground).
 - If an interlock circuit is not installed in your test fixture or connection interface, you must install and connect the interlock circuit that opens the interlock terminal when the shielding box access door is opened.
 - If you change the connection interface, test fixture, prober, and such, connect an interlock cable to the one actually used.
 - Confirm periodically that the interlock function works normally.
 - Before touching the connections on the High Force, High Sense, and Guard terminals, turn the instrument off and discharge any capacitors. If you do *not* turn the instrument off, complete *all* of the following items, regardless of the instrument settings.
 - Press the **On/Off** switch, and confirm that the switch turns off.
 - Confirm that the **On/Off** switch does not turn red.
 - Open the fixture cover or the shielding box access door (open interlock).
 - Discharge any capacitors connected to a channel.
 - Warn persons working around the instrument about dangerous conditions.
-

WARNING

Une tension dangereuse (max. \pm pour; 210 Vdc) émanant du dispositif l'instrument peut être sortie aux bornes High Force, High Sense et Guard. Les précautions suivantes doivent être observées contre commotion électrique accidentelle.

- Utilisez un cordon d'alimentation CA à trois connecteurs pour connecter la cabine (si utilisée) et l'instrument à la mise électrique à la terre (sol de sécurité).
- Si un circuit de sécurité n'est pas installé dans votre test d'installation ou dans votre interface de connexion, vous devez installer et connecter le circuit de sécurité qui ouvre la borne d'enclenchement lorsque la porte d'accès à la protection de la boîte est ouverte.
- Si vous changez l'interface de connexion, un test d'installation, la sonde, ou toute autre élément, connectez un cordon d'enclenchement à celui utilisé actuellement.
- Vérifiez régulièrement que la fonction de verrouillage fonctionne normalement.
- Avant de toucher les connexions des bornes High Force, High Sense et Guard, éteignez l'instrument et déchargez tous les condensateurs. Si vous n'éteignez pas l'appareil, complétez tous les éléments suivants, indépendamment des réglages de l'appareil.
 - Appuyez sur le bouton On/Off, et confirmez que le signal lumineux est éteint.
 - Vérifiez que le bouton On/Off ne devienne pas rouge.
 - Ouvrez le couvercle d'appareil ou la protection du boîtier de la porte d'accès (verrouillage ouvert).
 - Déchargez tous les condensateurs connectés au réseau.
- Informez les personnes se trouvant à proximité de l'appareil à propos des conditions dangereuses.

Inspecting the Shipment

Perform the following inspections when the Keysight B2900 and accessories arrive at your site.

1. Before unpacking any component, inspect all boxes for any signs of damage that might have occurred during shipment, such as:
 - dents
 - scratches
 - cuts
 - water marks

If you suspect any damage, contact your nearest Keysight Sales and Support Office.

2. When you open the boxes that contain the B2900 and accessories, check the components against the contents lists attached to the boxes.

If anything is missing, contact your nearest Keysight Sales and Support Office.

3. Verify the operation of B2900 as described in [“Checking the Operation of Keysight B2900”](#).

If any problem occurs, contact your nearest Keysight Sales and Support Office.

Checking the Operation of Keysight B2900

1. Make sure that the standby switch is set to off.
2. Connect the power cord from the B2900’s rear panel AC input connector (receptacle) to an AC power outlet at your site.
3. Press the standby switch to turn on the instrument.

The initialization screen will appear on the B2900’s front panel display, and the power-on self-test is automatically executed.

If the B2900 is operating normally, the front panel LCD displays as shown in [Figures 3-1](#) or [3-2](#).

Figure 3-1 Display Example for 1-ch Model

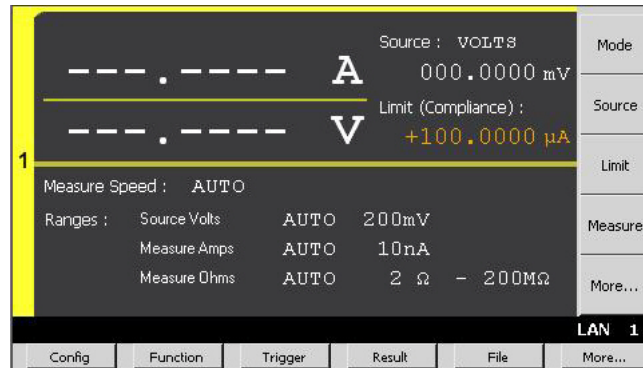
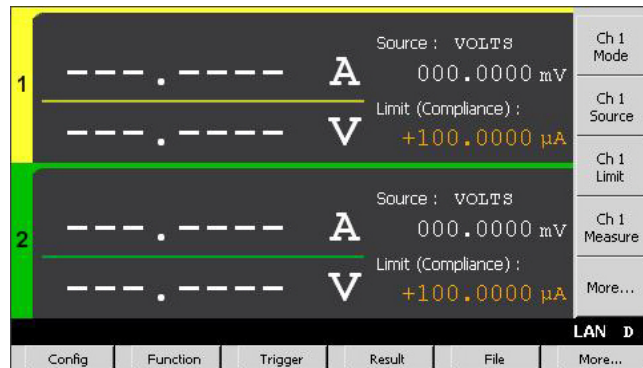

Figure 3-2 Display Example for 2-ch Model



Checking for Errors

Errors can be checked as described below.

1. Press the More > System > Error > Log function keys. This opens the Error Log dialog box.
2. Check the errors displayed on the dialog box.
If no error is detected, "0, No Error" is displayed.
3. Press the OK softkey to close the dialog box.

Installing the Keysight B2900

This section describes information you must pay attention to when installing the Keysight B2900.

- “Safety Considerations”
- “Environment”
- “Connecting the Power Cord”
- “Setting the Power Line Frequency”
- “Setting Date and Time”
- “Bench Installation”
- “Rack Installation”

Safety Considerations

Refer to the Safety Summary page at the beginning of this guide for general safety information. Before installation or operation, check the B2900 and review this guide for safety warnings and instructions. Safety warnings for specific procedures are located at appropriate places throughout this guide.

Environment

WARNING

Do not operate the instrument in dusty environment, or in the presence of flammable gases, corrosive gases, or fumes.



Ne pas utiliser l'appareil dans un endroit poussiéreux, ou en présence de gaz inflammables, corrosifs ou de fumée.

Environmental conditions for the B2900 are described below. The B2900 is designed for use in indoor facilities.

- Temperature range
 - Operating** 0 °C to +55 °C
 - Storage** -30 °C to +70 °C

- Humidity range
 - Operating** 30 % to 80 %RH, non-condensing
 - Storage** 10 % to 90 %RH, non-condensing
- Altitude
 - Operating** 0 m to 2,000 m (6,561 ft.)
 - Storage** 0 m to 4,600 m (15,092 ft.)
- Power requirement: 100-240 V (± 10 %), 50/60 Hz
- Maximum volt-amps (VA): 250 VA
- Dimensions
 - Without handle and feet: 88 mm (H) \times 213 mm (W) \times 450 mm (D)
 - Bench configuration (with handle and feet): 180 mm (H) \times 260 mm (W) \times 480 mm (D)

Fan cools the instrument by drawing air through the sides and exhausting it out the back. The instrument must be installed in a location that allows sufficient space at the sides and back of the instrument for adequate air circulation.

Connecting the Power Cord

WARNING

FIRE HAZARD: Use only the power cord supplied with your instrument. Using other types of power cord may cause overheating of the power cord, resulting in fire.



SHOCK HAZARD: The power cord provides the chassis ground through a third conductor. Be sure to connect to a three-conductor type power outlet with the correct pin grounded.







RISQUE D'INCENDIE : utilisez uniquement le câble d'alimentation fourni avec votre appareil. L'utilisation d'autres types de câble d'alimentation peut provoquer une surchauffe du câble d'alimentation et provoquer un incendie.

RISQUE DE CHOC ÉLECTRIQUE: le câble d'alimentation fournit la masse du châssis par le biais d'un troisième conducteur. Assurez-vous de connecter la prise d'alimentation de type trois conducteurs avec la broche correcte mise à la terre.

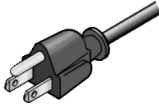
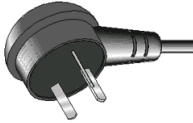
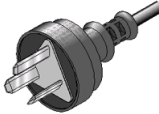
NOTE

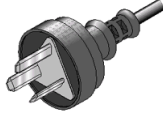
The detachable power cord may be used as an emergency disconnecting device. Removing the power cord will disconnect AC input power to the instrument.

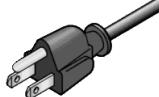
<p>Option 900</p>  <ul style="list-style-type: none"> • Plug: BS 1363/A, 250 V, 10 A • PN: 8120-4420 	<p>Option 901</p>  <ul style="list-style-type: none"> • Plug: AS/NZS 3112, 250 V, 10 A • PN: 8120-4419 	<p>Option 902</p>  <ul style="list-style-type: none"> • Plug: IEC 60277-1, 250 V, 10 A • PN: 8121-1226 	<p>Option 903</p>  <ul style="list-style-type: none"> • Plug: NEMA 5-15P, 125 V, 10 A • PN: 8121-3446
<p>Option 904</p>  <ul style="list-style-type: none"> • Plug: NEMA 6-15P, 250 V, 10 A • PN: 8120-3996 	<p>Option 906</p>  <ul style="list-style-type: none"> • Plug: SEV 1011, 250 V, 10 A • PN: 8120-4416 	<p>Option 912</p>  <ul style="list-style-type: none"> • Plug: SB 107-2-D1, 250 V, 10 A • PN: 8121-1655 	<p>Option 917</p>  <ul style="list-style-type: none"> • Plug: IS 1293 and IS 6538, 250 V, 10 A • PN: 8121-1690

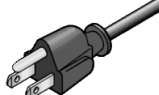
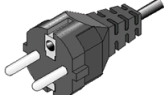
<p>Option 918</p>  <ul style="list-style-type: none"> • Plug: JIS C 8303, 125 V, 12 A • PN: 8121-0743 	<p>Option 919</p>  <ul style="list-style-type: none"> • Plug: Israel SI 32, 250 V, 10 A • PN: 8121-0724 	<p>Option 920</p>  <ul style="list-style-type: none"> • Plug: IRAM 2073, 250 V, 10 A • PN: 8121-0725 	<p>Option 921</p>  <ul style="list-style-type: none"> • Plug: CEI 23-16, 250 V, 10 A • PN: 8121-0722
<p>Option 922</p>  <ul style="list-style-type: none"> • Plug: GB 1002 figure 3, 250 V, 10 A • PN: 8120-8376 	<p>Option 923</p>  <ul style="list-style-type: none"> • Plug: SANS 164-1, 250 V, 10 A • PN: 8121-0564 	<p>Option 927</p>  <ul style="list-style-type: none"> • Plug: NEMA WD-6, 250 V, 10 A • PN: 8120-0674 	<p>Option 930</p>  <ul style="list-style-type: none"> • Plug: NBR 14136, 250 V, 10 A • PN: 8121-1809
<p>Option 931</p>  <ul style="list-style-type: none"> • Plug: CNS 10917-2, 125 V, 10 A • PN: 8121-1635 	<p>Option 932</p>  <ul style="list-style-type: none"> • Plug: CS 0017, 250 V, 10 A • PN: 8121-1638 		

Connect the power cord to the IEC 60320 connector on the rear of the instrument. If the wrong power cord was shipped with your instrument, contact Keysight Technologies.

The AC input on the back of your instrument is a universal AC input. It accepts nominal line voltages in the range of 100 to 240 VAC.

Setting the Power Line Frequency

The power line frequency must be set properly for the AC power at your site. Press the following function keys to set the frequency to 50 Hz or 60 Hz.

- For setting to 50 Hz: More > System > PLC > 50 Hz
- For setting to 60 Hz: More > System > PLC > 60 Hz

Setting Date and Time

You can set the date and time on the Date and Time dialog box opened by pressing System > Info. > Date/Time function keys.

Bench Installation

Do not block the air intake at the sides and the exhaust at the rear of the B2900. Minimum clearances for bench operation are 5 mm along the sides and 100 mm along the back.

For easier display viewing and measurement terminal access, you can tilt up the front of the instrument by turning the handle. To adjust the handle, grab the handle by the sides and pull outward. Then, rotate the handle to the desired position.



Rack Installation

NOTE

Use the Rack Mount kit (34190A) to rack mount the Keysight B2900.

Keysight B2900 can be mounted in a 19-inch EIA rack cabinet. It is designed to fit in two rack-units (2U) of space.

Remove the front and rear rubber bumpers and the handle before rack mounting the B2900.

Do not block the air intake at the sides and the exhaust at the rear of the B2900.

Removing the Bumper

Stretch a corner of the rubber bumper and slide it off.

Removing the Handle

1. Grab the handle by the sides and pull outward. This will allow you to rotate the handle.
2. Rotate the handle to a vertical position. Then, position the instrument horizontally.
3. Pull outward and then lift the handle upward.



CAUTION

When reattaching the handle, pay attention to its direction. Incorrect attachment may damage the hardware.

Maintenance

Maintenance should be performed periodically to keep the Keysight B2900 in good condition. If problems arise, contact your nearest Keysight Sales and Support Office.

- “Cleaning”
- “Self-test”
- “Self-calibration”
- “Calibration”

Cleaning

WARNING

SHOCK HAZARD: To prevent electric shock, unplug the B2900 before cleaning.



Risques de choc électrique : afin d'éviter tout choc électrique, débranchez le B2900 avant d'effectuer le nettoyage.

Use a dry cloth or a cloth slightly dampened with water to clean the external case parts. Do not use detergents or chemical solvents. Do not attempt to clean internally.

Self-test

Keysight B2900 provides the self-test function to check the operation. The self-test is automatically performed when the instrument is turned on. It is recommended to perform the self-test for the following condition or purpose. Before performing the self-test, turn the channel output off and disconnect test leads and cables from the terminals.

- If a channel is in the lock condition due to over temperature

In this condition, the Emergency dialog box is displayed on the gray background screen, however this is not shown in the remote status if the remote display is set to OFF. And the ERR indicator turns on and the On/Off switch is not effective.

Perform the self-test to unlock the channel. The channel can be used soon if the self-test does not report any problem.

- If you feel that the instrument may be defective
- For preventive maintenance

**To perform
self-test**

The following procedure shows how to perform the self-test.

1. If it is in the remote state, press the Cancel / Local key.
2. Press the On/Off switch and confirm that the switch turns off.
3. Disconnect test leads and cables from the channel terminals.
4. Press the following function keys.
More > System > Cal/Test > Self-Test
Confirmation dialog box is opened.
5. Press the OK key. This starts the self-test.

Self-calibration

Keysight B2900 provides the self-calibration function to maintain the measurement performance. If the environmental temperature changes ± 3 °C or more, perform the self-calibration. This is effective for the accurate measurements by minimizing the effect of thermal drift. The self-calibration must be performed after warming-up of 60 minutes. Before performing the self-calibration, turn the channel output off and disconnect test leads and cables from the terminals.

**To perform
self-calibration**

The following procedure shows how to perform the self-calibration.

1. If it is in the remote state, press the Cancel / Local key.
2. Press the On/Off switch and confirm that the switch turns off.
3. Disconnect test leads and cables from the channel terminals.
4. Press the following function keys.
More > System > Cal/Test > Self-Cal
Confirmation dialog box is opened.
5. Press the OK key. This starts the self-calibration.

Calibration

Calibration and adjustments must be performed periodically so that the instruments satisfy the specifications, and keep a good condition. It is recommended to perform the calibration once a year at least. For the calibration and adjustments, contact your nearest Keysight Sales and Support Office. Trained service personnel will perform the calibration and adjustments.

Connecting a DUT

This section describes how to connect a device under test (DUT) to the Keysight B2900 source/measure terminals.

NOTE

Set the channel output off when changing the connections. If not, the DUT may be damaged.

To set the channel output off, press the **On/Off** switch and confirm that the switch LED turns off.

This section includes the following descriptions.

- [“2-Wire Connections or 4-Wire Connections”](#)
- [“Floating”](#)
- [“Using Test Leads”](#)
- [“Using the N1295A Test Fixture”](#)
- [“Using the 16442B Test Fixture”](#)
- [“Guarding”](#)
- [“Performing Low Current Measurements”](#)

NOTE

Connecting the interlock circuit

B2900 provides an interlock function to prevent the user from receiving an electrical shock from high voltages over ± 42 V. If the Digital I/O interlock terminal is open, B2900 *cannot* apply a high voltage.

For high voltage measurement, connect the interlock terminal to the interlock circuit as described in [“Installing the Interlock Circuit” on page 91](#).

NOTE

Generally, environmental conditions, such as electromagnetic environment, have a negative impact on the performance of the instrument. Use coaxial cables and shielding technique to minimize the impact.

WARNING



To avoid touching the end of the extension cable or the terminal area with the DUT, cover over the conductors with insulator. Also it is important to protect the terminal area by using the grounded shield cover and such.

To prevent electrical shock and DUT damage, do not connect or disconnect the DUT while the instrument is applying voltage or current.

When you touch the DUT after measurement, devise a countermeasure of residual charge and heat to prevent electrical shock and burn. Use glove and any tool. Also have enough time for discharge and radiation.

Afin d'éviter de toucher l'extrémité du câble d'allongement ou l'aire de la borne avec l'appareil mis sous tension (AST), couvrez les conducteurs avec l'isolant. En outre, il est important de protéger la zone de la borne en utilisant le couvercle d'écran à la mise à terre, ou tout autre élément.

Afin d'éviter toute décharge électrique et dommage MST, ne branchez ou déconnectez pas la sortie MST alors que la source de sortie est appliquée.

Lorsque vous touchez le MST après la mesure, élaborer une contre-mesure de la charge résiduelle et du chauffage afin d'éviter tout choc électrique et toute brûlure. Utilisez des gants et des outils. Prévoyez également du temps pour la décharge et la radiation.

2-Wire Connections or 4-Wire Connections

When connecting a DUT, you can choose the connection type either 2-wire connections or 4-wire connections.

If you want to simplify the connections, use 2-wire connections by connecting the Force terminals only and opening the Sense terminals. The Force terminals can be used to apply and measure DC voltage or current.

To make 4-wire connections, remote sensing, well known as Kelvin connections, use both Force and Sense terminals. Connecting the Force and Sense lines together at the terminal of the DUT minimizes the measurement error caused by the residual resistance of the test leads or cables. This connection is effective for low resistance measurements and high current measurements.

To specify the connection type (Sensing Type), perform the following procedure.

1. Press the Config > Source > Connection function keys. This opens the Output Connection dialog box.

2. Set the Sensing Type on this dialog box. Choose 2-WIRE for 2-wire connections, or 4-WIRE for 4-wire connections.
3. Press the OK softkey. For 4-wire connections, the following indicator appears on the Single view or the Dual view.

4-wire connection indicator: 

Figure 3-3

Dual View, 4-Wire Connection Setup for Channel 1



Floating

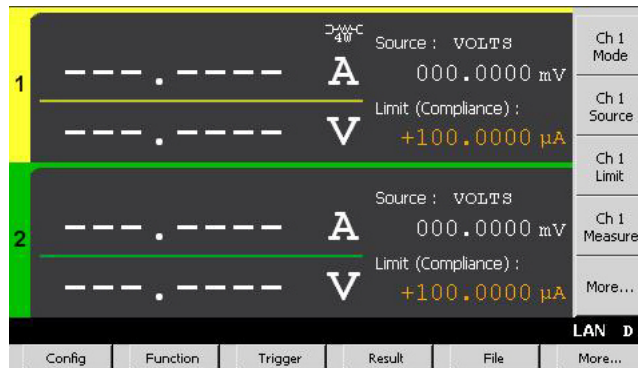

With the default setting, Low Force terminal is connected to the chassis ground. However, it can be internally disconnected from the ground for making the floating condition. This setup is used for connecting the source channels in series.

To specify the low terminal status, perform the following procedure. Setting is not saved. Turning off the instrument sets the status to the grounded.

1. Press the Config > Source > Connection function keys. This opens the Output Connection dialog box.
2. Set the Low Terminal State on this dialog box. It must be FLOATING for the floating status, or GROUNDED for the grounded status.
3. Press the OK softkey.

For the floating status, the following indicator appears on the status information area. And then the Low Force and Low Sense terminals can be connected to the maximum of ± 250 V.

Channel 1 floating status indicator: 

Channel 2 floating status indicator: 

Figure 3-4 Dual View, Floating Status for Channels 1 and 2

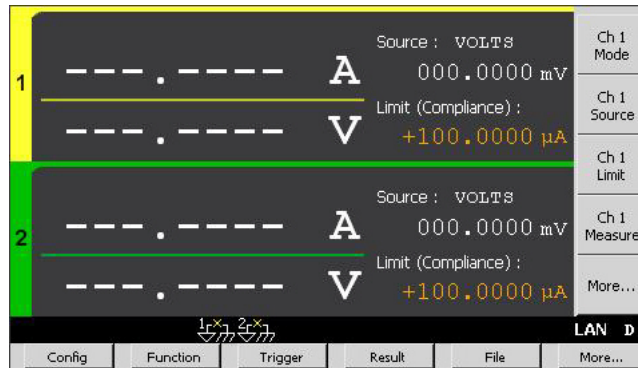

CAUTION

Do not apply current to the chassis ground. Doing so will damage the B2900.

WARNING



To prevent electrical shock, do not touch any of measurement circuit at any time while a floating measurement is in progress. Also use accessories that comply with IEC 61010-031. All terminals and the extended conductors must be isolated by using insulation caps, sleeves, etc.

Afin d'éviter toute décharge électrique, ne touchez aucune mesure de circuit à tout moment lorsque la mesure de flottement est en cours. Utiliser également des accessoires qui sont conformes à la norme IEC 61010-031. Toutes les bornes et les conducteurs prolongés doivent être isolés en utilisant des bouchons d'isolation, des manchons, etc.

Using Test Leads

B2900 source/measure terminals use banana jacks. For connecting a DUT, the following test leads are available. **Figure 3-5** shows the connections for two-terminal device measurements.

- Keysight U8201A Combo Test Lead Kit

Couple of test leads, test probes, alligator clips, SMT grabbers, fine-tips test probes, and banana plugs, CAT III 1000 V, 15 A maximum

Two kits are required for 4-wire connections.



- Keysight 11059A Kelvin Probe Set

Test leads for 4-wire connections, 42 V maximum



Figure 3-5 Connecting a Two-Terminal Device

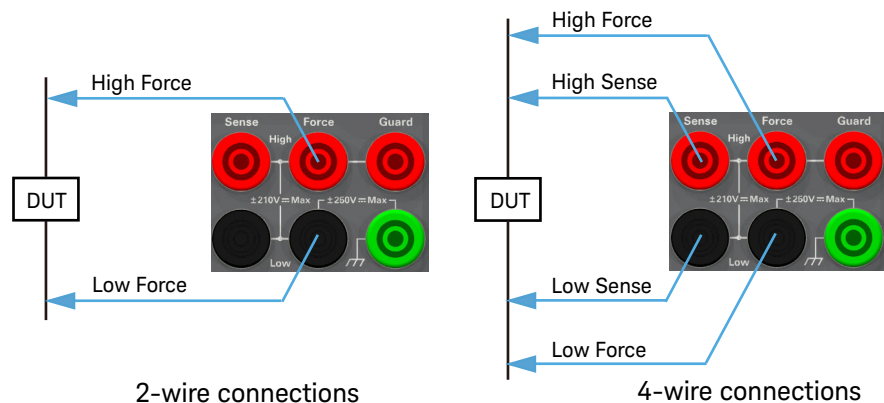

Using the N1295A Test Fixture

Keysight N1295A is a test fixture which has four triaxial connectors and which supports two 2-wire connections.

- Requirements**
- Keysight N1295A test fixture furnished with pin clip wire 4 ea. and pin plug wire 2 ea.
 - Keysight N1297A banana to triaxial adapter for 2-wire connections
 - Triaxial cable, 2 ea. for one 2-wire connection

Connections



1. Attach the banana to triaxial adapter to the B2900 source/measure terminals. See [Figure 3-6](#). If there is some space as “Bad connection”, the contact is not enough.
2. Connect the triaxial cables between the adapter and N1295A as shown in [Figure 3-7](#).
3. Connect the DUT between terminals 1 and 2 for the example in [Figure 3-7](#).

Figure 3-6 Attaching Banana to Triaxial Adapter

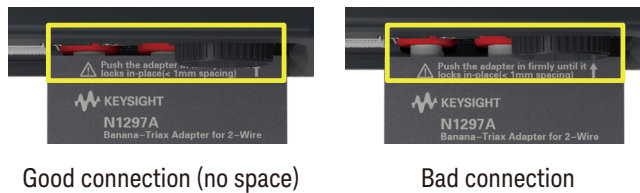
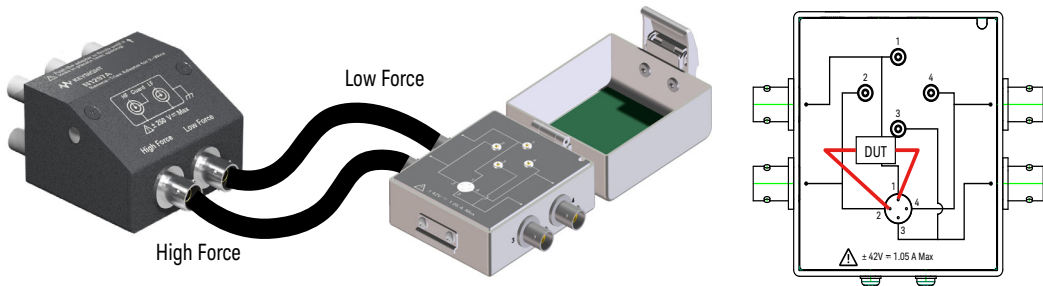

Figure 3-7 Keysight N1295A Connection Example



NOTE**Shielding**

N1295A is equipped with a cover. To minimize the effect of ambient noise, close the cover when performing measurements.

CAUTION**Maximum voltage and current**

The test fixture and adapters must be used under the following limitations to prevent damage.

Keysight N1297A: ± 250 V maximum, ± 42 V maximum for connecting N1295A

Keysight N1297B: ± 250 V maximum, ± 42 V maximum for connecting N1295A

Keysight N1295A: ± 42 V, 1.05 A maximum

Using the 16442B Test Fixture

Keysight 16442B is a test fixture which has six triaxial connectors for source/measure unit (SMU), the GNDU connector for the ground unit of a parameter/device analyzer, the Intlk connector for the interlock control, and six coaxial connectors for other instruments. See *Keysight 16442B User's Guide* for details and accessories of the 16442B.

- Requirements**
- Keysight 16442B test fixture furnished with pin clip wire, pin plug wire, etc.
 - Keysight N1297A banana to triaxial adapter for 2-wire connections
 - Keysight N1297B banana to triaxial adapter for 4-wire connections
 - Triaxial cable, 2 ea. for 2-wire connections, and 3 ea. for 4-wire connections

NOTE**Shielding**

16442B is equipped with a cover. To minimize the effect of ambient noise, close the cover when performing measurements.

CAUTION

Maximum voltage and current

The test fixture and adapters must be used under the following limitations to prevent damage.

Keysight N1297A: ± 250 V maximum, ± 200 V maximum for connecting 16442B

Keysight N1297B: ± 250 V maximum, ± 200 V maximum for connecting 16442B

Keysight 16442B: ± 200 V, 1 A maximum for SMU input

Connections



1. Attach the banana to triaxial adapter to the B2900 source/measure terminals. See [Figure 3-6](#). If there is some space as “Bad connection”, the contact is not enough.
2. Connect the triaxial cables between the adapter and the 16442B. [Figure 3-8](#) shows a connection example.
3. Connect the DUT on the 16442B wiring panel by using the 16442B’s furnished accessories, socket module, blank board, and wire suitable for the DUT.

[Figure 3-9](#) shows the connection example for the connections of [Figure 3-8](#).

For 2-wire connections, connect the SMU 1 Force terminal to a DUT terminal, and connect the SMU 2 Force terminal to the other DUT terminal.

For 4-wire connections, connect the SMU 1 Force and Sense terminals to a DUT terminal. And connect the SMU 3 Sense and Guard terminals to the other DUT terminal if the adapter’s Low Force/Low Sense connector is connected to the SMU 3 Sense connector. The Low Force signal appears on the Guard terminal.

Figure 3-8

Connection Example between N1297A and 16442B

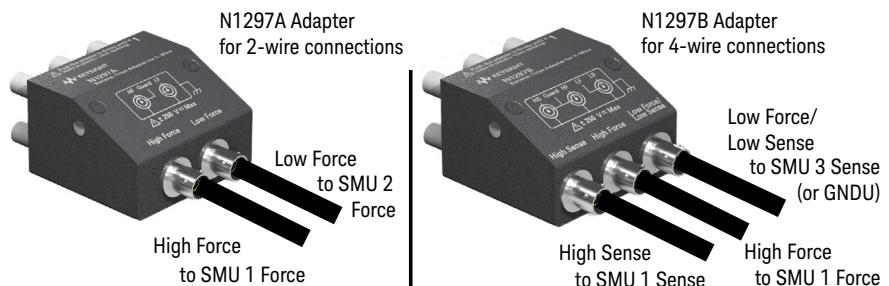
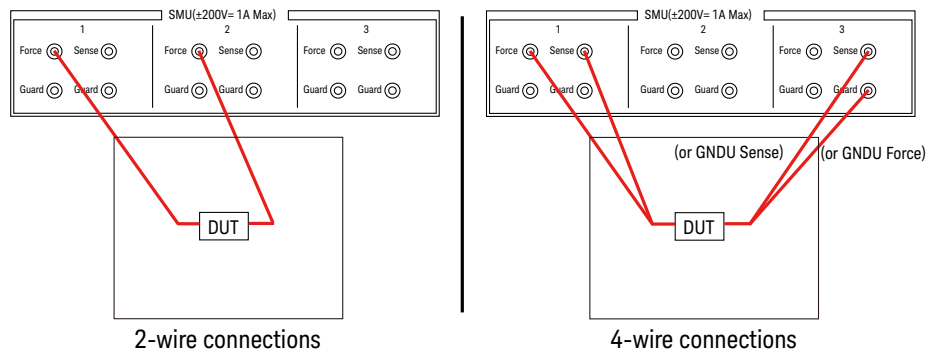

Figure 3-9

Connection Example of 16442B Wiring Panel



NOTE

Performing high voltage measurement

When the Digital I/O interlock terminal is open, B2900 cannot apply high voltage over ± 42 V. To perform high voltage measurements, B2900 must be connected to the interlock circuit installed in 16442B.

Prepare the N1297A or N1297B interlock cable, and connect it between the B2900 Digital I/O connector and the 16442B Intlk connector. B2900 can apply a high voltage when the test fixture cover is closed.

WARNING



Hazardous voltage, instrument maximum output voltage may appear at the High Force, High Sense, and Guard terminals if the fixture cover is closed. To prevent electrical shock, do *not* expose these lines.

Une tension dangereuse, une tension de sortie maximale de l'appareil peut apparaître aux bornes High Force, High Sense et Guard si le couvercle de l'équipement est fermé. Afin d'éviter toute décharge électrique, n'exposez pas ces lignes.

Guarding

Guarding reduces the leakage current between the instrument and a DUT. This is important when you measure a low current.

Figure 3-10 shows the theory of guarding. The buffer amplifier ($\times 1$) keeps the potential of the Guard conductor at the same potential as the High Force conductor, so that the current does not flow between the High Force and Guard conductors. Therefore, the current measured by the instrument is the same as the current at the DUT terminal because no current is leaked.

For the connection examples shown in Figures 3-7 and 3-8, the guard is extended to the test fixture input connectors with triaxial cables.

Figure 3-10

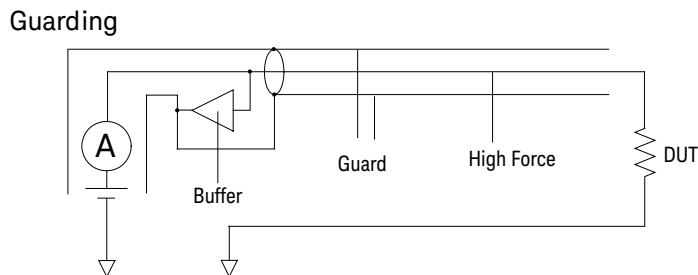

CAUTION

Never connect the Guard terminal to any output, including circuit common, chassis ground, or any other guard terminal. Doing so will damage the B2900.

Performing Low Current Measurements

With the default setting, 10 nA and 100 nA measurement ranges are not used. For the low current measurements, the measurement range settings must be changed.

To change the measurement range

1. Press the View key to display the Single view.

If the Range parameters are not displayed in the lower half of the Single view, press the More, Hide Sweep, Hide Pulse, or Hide Trigger assist key to display the Range parameters.

2. Change the setting of the Measure Amps field of the Range parameters.

Set AUTO for the auto ranging or FIXED for the fixed range.

Set 10 nA or 100 nA for the minimum or fixed measurement range.

Installing the Interlock Circuit



The interlock circuit is a simple electric circuit, as shown in [Figure 3-11](#). The circuit electrically opens when an access door is opened, and closes when the door is closed.

B2900 cannot apply high voltages over ± 42 V when the Digital I/O interlock terminal is open. To perform high voltage measurements, the B2900 interlock terminal must be connected to the interlock circuit installed in the measurement environment such as the shielding box. The interlock circuit is important and necessary to prevent electrical shock when the user touches the measurement terminals.

WARNING



Hazardous voltage, instrument maximum output voltage may appear at the High Force, High Sense, and Guard terminals if the fixture cover is closed. To prevent electrical shock, do *not* expose these lines.

Une tension dangereuse, une tension de sortie maximale de l'appareil peut apparaître aux bornes High Force, High Sense et Guard si le couvercle de l'équipement est fermé. Afin d'éviter toute décharge électrique, n'exposez pas ces lignes.

Figure 3-11 Interlock Circuit

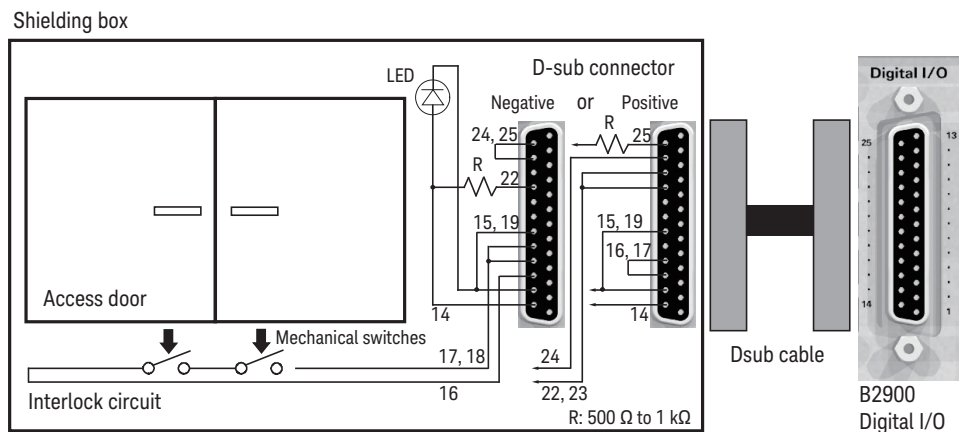

Installation

Installing the Interlock Circuit

- Requirements**
- LED (Keysight part number 1990-0486 or equivalent), 1 ea.
 - Mechanical switch (Keysight N1254A-402 or equivalent), 2 ea.
 - Resistor, 500 Ω to 1 k Ω (choose lower one to get higher output of LED), 1 ea.
 - 25-pin D-sub connector (for wiring, mounted on the shielding box), 1 ea.
 - Connection wire
 - 25-pin D-sub cable, 1 ea.
- Procedure**
1. Mount two mechanical switches onto your shielding box, so that the switches close when the access door is closed, and open when the door is opened. See [Figure 3-13](#) for the switch dimensions.
 2. Mount an LED onto your shielding box. See [Figure 3-12](#) for the LED dimensions.

The LED is used as a high voltage indicator which is lit when B2900 is in the high voltage output status.
 3. Mount a D-sub connector onto your shielding box.
 4. Use a wire and short the following pins of the D-sub connector. See [Figure 3-11](#) for a connection example.

For the negative logic: Pins 24 and 25
For the positive logic: Pins 16 and 17
 5. Use a wire and connect the two switches in series between the following pins of the D-sub connector. See [Table 3-1](#) for the Digital I/O pin assignment.

For the negative logic: Pins 16 and some ground pins
The ground pins are pin numbers 15 and 17 to 21.
For the positive logic: Pins 24 and some +5 V pins
The +5 V pins are pin numbers 22, 23, and 25.
 6. Use a wire and connect the LED between the pin 14 and some ground pins of the D-sub connector. Then set the pin 14 to HIGH VOLTAGE LAMP. See [“DIO Configuration Dialog Box” on page 155](#).
 7. Connect a resistor between the pin 14 and an unused +5 V pin.

Figure 3-12 Dimensions of the LED (Keysight part number 1990-0486)

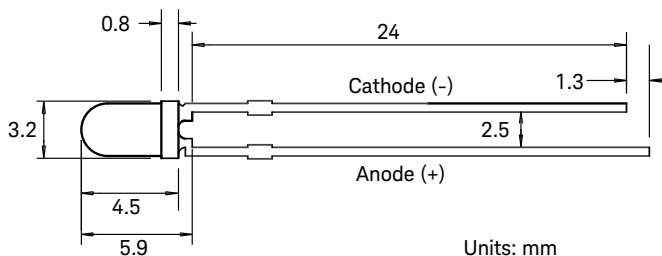
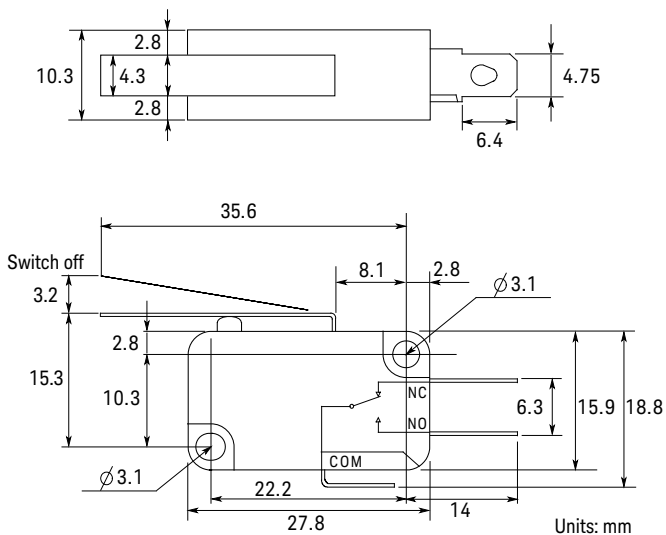

Figure 3-13 Dimensions of the Interlock Switch (Keysight N1254A-402)



Connecting to the Interfaces

CAUTION

Electrostatic discharges greater than 1 kV near the interface connectors may cause the unit to reset and require operator intervention.

B2900 supports GPIB, LAN, and USB interfaces. All three interfaces are live at power-on. Connect your interface cable to the appropriate interface connector. Information on configuring the interfaces can be found later in this section.

The front panel LAN indicator is lit when the LAN port is connected and configured.

B2900 provides Ethernet connection monitoring. With Ethernet connection monitoring, the instrument's LAN port is continually monitored and automatically reconfigured.

GPIB/USB Interfaces

NOTE

For detailed information about GPIB and USB interface connections, refer to *Connectivity Guide* installed with the Keysight IO Libraries.

The following steps will help you quickly get started connecting your instrument to the GPIB (General Purpose Interface Bus). The following figure illustrates a typical GPIB interface system.

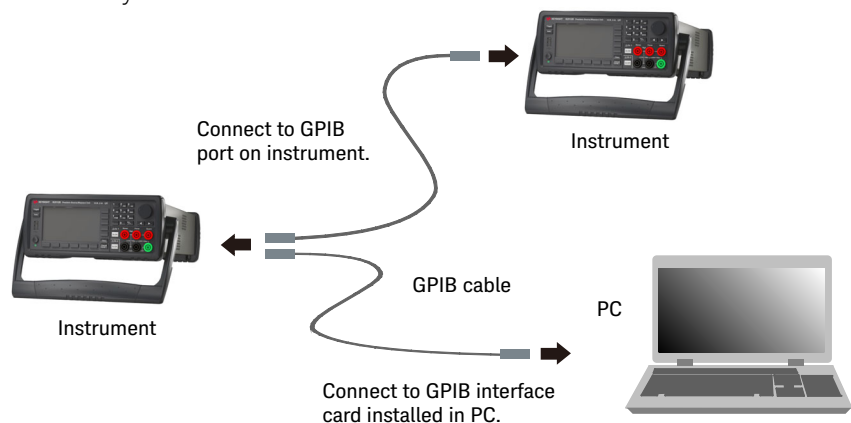

1. If you have not already done so, install the Keysight IO Libraries Suite from the CD shipped with your product.
2. If you do not have a GPIB interface card installed on your computer, turn off your computer and install the GPIB card.
3. Connect your instrument to the GPIB interface card using a GPIB interface cable.
4. Use the Connection Expert utility from the Keysight IO Libraries Suite to configure the installed GPIB interface card's parameters.
5. B2900 is shipped with its GPIB address set to 23. To view or change the GPIB address, press the More function key, then the I/O > GPIB softkeys. The GPIB Configuration dialog box appears.

To change the GPIB address, use the rotary knob or the arrow keys, and press OK to set the value.

6. You can now use the Interactive IO within Connection Expert to communicate with your instrument, or program your instrument using various programming environments.

The following steps will help you quickly get started with connecting your USB-enabled instrument to the USB (Universal Serial Bus). The following figure illustrates a typical USB interface system.

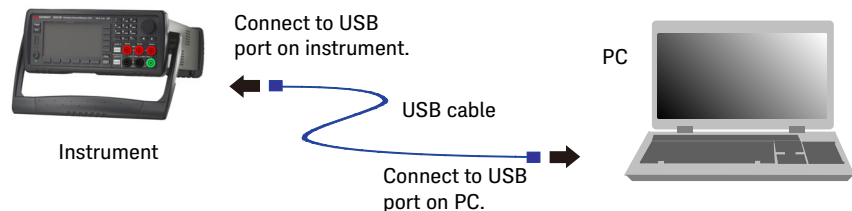

1. If you have not already done so, install Keysight IO Libraries Suite from the CD shipped with your product.
2. Connect the USB device port located on the back of your instrument to the USB port on your computer.
3. With the Connection Expert utility from Keysight IO Libraries Suite running, the computer will automatically recognize the instrument. This may take several seconds. When the instrument is recognized, your computer will display the VISA alias, IDN string, and VISA address.

You can also view the instrument's VISA address from the front panel. Press the More function key, then the I/O > USB softkeys. The VISA address is shown in the USB Status dialog box.

4. You can now use the Interactive IO within Connection Expert to communicate with your instrument, or program your instrument using various programming environments.

LAN Interface

NOTE

For detailed information about LAN interface connections, refer to *Connectivity Guide* installed with the Keysight IO Libraries.

The following steps will help you quickly get started with connecting and configuring your instrument on a local area network.

Connecting to a Site LAN

A site LAN is a local area network in which LAN-enabled instruments and computers are connected to the network via routers, hubs, and/or switches. They are typically large, centrally-managed networks with services such as DHCP and DNS.

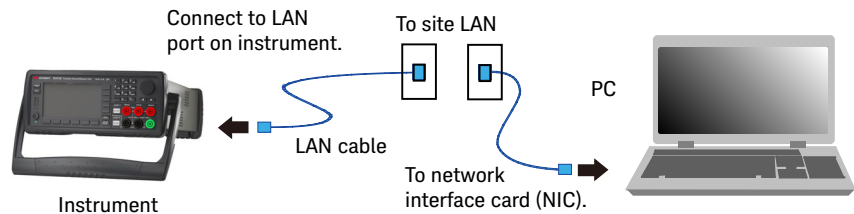

1. If you have not already done so, install the Keysight IO Libraries Suite from the CD shipped with your product.
2. Connect the instrument to the site LAN. The factory-shipped instrument LAN settings are configured to automatically obtain an IP address from the network using DHCP (DHCP is enabled). Note that this may take up to one minute. The DHCP server will register the instrument's hostname with the dynamic DNS server. The hostname as well as the IP address can then be used to communicate with the instrument. The front panel LAN indicator will turn green when the LAN port has been configured successfully, or turn red if the configuration fails.

NOTE

If you need to manually configure any instrument LAN settings, see “[LAN Configuration Dialog Box](#)” on page 155 for information about configuring the LAN settings from the front panel of the instrument.

3. Use the Connection Expert utility from Keysight IO Libraries Suite to add the B2900 and verify the connection. To add the instrument, you can request Connection Expert to discover the instrument. If the instrument cannot be found, add the instrument using the instrument’s hostname or IP address.
-

NOTE

If this does not work, refer to the troubleshooting section in *Connectivity Guide*.

4. You can now use the Interactive IO within Connection Expert to communicate with your instrument, or program your instrument using various programming environments. You can also use the Web browser on your computer to connect to the instrument as described under “[Using the Graphical Web Interface](#)” on page 98.

Viewing the Active LAN Status

To view the currently active LAN settings, press the More function key, then the I/O > LAN > Status softkeys. The LAN status dialog box appears.

Note that the currently active LAN settings for the IP Address, Subnet Mask, and Default Gateway may be different from the settings specified in the LAN Configuration dialog box, depending on the configuration of the network. If the settings are different, it is because the network has automatically assigned its own settings.

Modifying the LAN Settings

As shipped from the factory, B2900’s pre-configured settings should work in most LAN environments. If you need to manually configure these settings, press the More function key, then the I/O > LAN > Config softkeys. The LAN Configuration dialog box appears.

NOTE

B2900 must be rebooted if the host name is changed.

For the LAN setup parameters, see “[LAN Configuration Dialog Box](#)” on page 155.

Communicating Over the LAN

Using the Graphical Web Interface

Your Keysight B2900 Source/Measure Unit has a built-in graphical web interface that lets you control it directly from a Web browser on your computer. Multiple simultaneous connections are allowed, but only from one computer. With additional connections, performance will be reduced. Multiple connections from multiple computers are not allowed.

With the graphical web interface, you can access the front panel control functions including the LAN configuration parameters. This is a convenient way to communicate with the B2900 without using I/O libraries or drivers.

NOTE

The built-in graphical web interface only operates over the LAN interface. It requires Internet Explorer 6+ or Firefox 2+. You will also need the Java Plug-in. This is included in the Java Runtime Environment. Visit the Java's website.

The graphical web interface is enabled when shipped.

Description	
Model number	B2912B
Manufacturer	Keysight
Serial number	MY12345678
Firmware revision	0.0.0.0
Description	Keysight B2912B Precision Source/Measure Unit - MY12345678

To launch the graphical web interface:

1. Open a Web browser on your computer.
2. Enter the instrument's hostname or IP address into the browser's Address field to launch the graphical web interface. The B2900 home page will appear.
3. Click on the Browser Web Control button in the navigation bar on the left to begin controlling your instrument.
4. For additional help about any page, click "Help with this Page".

If desired, you can control the access to the graphical web interface using password protection. As shipped from the factory, the password is set to *Keysight*, or *keysight*. To change the password, click on the View & Modify Configuration button. Refer to the online help for additional information about setting the password.

Using Telnet

The Telnet utility (as well as sockets), is another way to communicate with B2900 without using I/O libraries or drivers. In all cases, you must first establish a LAN connection from your computer to the B2900 as previously described.

In an MS-DOS Command Prompt box, type "telnet *hostname* 5024" where *hostname* is the B2900's hostname or IP address, and 5024 is the instrument's telnet port. You should get a Telnet session box with a title indicating that you are connected to the B2900. Type the SCPI commands at the prompt.

Using Sockets

NOTE

Keysight B2900 allows any combination of up to four simultaneous data socket, control socket, or telnet connections to be made.

Keysight instruments are standardized on using port 5025 for SCPI socket services. A data socket on this port can be used to send and receive ASCII/SCPI commands, queries, and query responses. All commands must be terminated with a newline for the message to be parsed. All query responses will also be terminated with a newline.

Installation

Communicating Over the LAN

The socket programming interface also allows control socket connections. The control socket can be used by a client to send device clear and to receive service requests. Unlike the data socket, which uses a fixed port number, the port number for a control socket varies and must be obtained by sending the following SCPI query to the data socket: **SYSTem:COMMunicate:TCPIP:CONTRol?**

Once the port number is obtained, a control socket connection can be opened. As with the data socket, all commands to the control socket must be terminated with a newline, and all query responses returned on the control socket will be terminated with a newline.

To send a device clear, send the string "DCL" to the control socket. When the B2900 has finished performing the device clear, it will echo the string "DCL" back to the control socket.

Service requests are enabled for control sockets using the Service Request Enable register. Once service requests have been enabled, the client program listens on the control connection. When SRQ becomes true, the instrument will send the string "SRQ +nn" to the client. The "nn" is the status byte value, which the client can use to determine the source of the service request.

Using Digital I/O

B2900 has a Digital I/O connector, D-sub 25 pin female, for general purpose input/output (GPIO). It can be used for:

- Trigger input
- Trigger output
- Digital signal input/output
- Digital signal input
- Start of Test (SOT) input (for component handlers)
- Busy status output (for component handlers)
- End of Test (EOT) output (for component handlers)
- Interlock control
- High voltage status output (shared with the digital signal input/output DIO 14)

The pin assignment of the Digital I/O connector is shown in [Table 3-1](#). Pins DIO 1 to DIO 14 can be assigned to one of the above functions, except for interlock control. To set the DIO functions, press the More function key, then the I/O > DIO > Config softkeys. For details, see [“DIO Configuration Dialog Box” on page 155](#).

[Figure 3-14](#) shows the input/output circuits internally connected to each pin of the Digital I/O connector.

For the available accessory, see [“Accessory for Digital I/O Connector” on page 103](#).

Figure 3-14 Digital I/O Internal Circuit

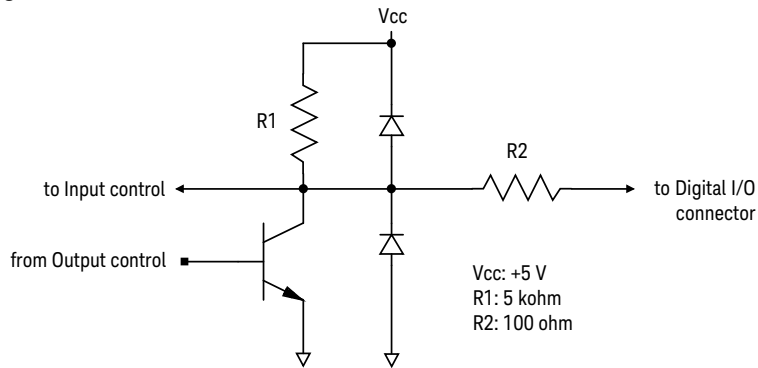

Table 3-1 Digital I/O Pin Assignment

Description	Pin Number	Description
+5 V ^a	25	DIO 13 (bit 13)
Interlock control ^b	24	DIO 12 (bit 12)
+5 V ^a	23	DIO 11 (bit 11)
+5 V ^a	22	DIO 10 (bit 10)
GND	21	DIO 9 (bit 9)
GND	20	DIO 8 (bit 8)
GND	19	DIO 7 (bit 7)
GND	18	DIO 6 (bit 6)
GND	17	DIO 5 (bit 5)
Interlock control ^c	16	DIO 4 (bit 4)
GND	15	DIO 3 (bit 3)
DIO 14 (bit 14) or High voltage status	14	DIO 2 (bit 2)
		1

a. Current limit: 600 mA (total current to the pins 22, 23, and 25)

b. Used for the positive logic. Connected to the pin 25 for the negative logic.

c. Used for the negative logic. Connected to the pin 17 for the positive logic.

Accessory for Digital I/O Connector

The following accessory is available for the Digital I/O connector.

- Keysight N1294A-031 GPIO-BNC Trigger Adapter

This adapter is used to change the Digital I/O connector to the trigger input/output BNC connectors. The BNC connectors are internally connected to the DIO pins 9 and 10.

This adapter can be connected directly to the Digital I/O connector.

Figure 3-15

N1294A-031 GPIO-BNC Trigger Adapter

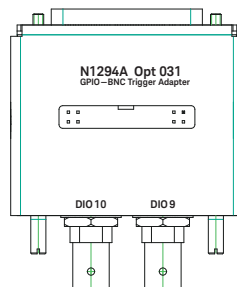

NOTE

Interlock terminals

If the N1294A-031 adapter is connected to the Digital I/O connector, the Interlock terminals are opened. Then the instrument output voltage is limited to ± 42 V.

To use the interlock function, see [“Installing the Interlock Circuit” on page 91](#) and extend the Interlock terminals. They can be extended from the adapter internal board through the opening of the adapter top cover.

Installation
Using Digital I/O

4 Front Panel Reference

Hard Keys and Rotary Knob	106
Display and Assist Keys	109
Function Keys	130
Config Key Group	132
Function Key Group	138
Trigger Key Group	143
Result Key Group	147
File Key Group	150
Program Key Group	151
I/O Key Group	152
Display Key Group	158
System Key Group	160

This chapter provides the reference information of the Keysight B2900 front panel keys and display.



NOTE

If measurement is not performed properly, check the trigger setting. The trigger type must be set to AUTO, or the trigger count (Count) must be set properly. See [“Trigger parameters” on page 122](#).

Hard Keys and Rotary Knob

Standby switch Turns the instrument on or off. When the power is on, the LED below the switch is turned green.

Trigger Starts a single (one shot) output/measurement or initiates trigger system. If a repeat measurement is in progress, stops it.

The single measurement is performed with the DC bias output, staircase sweep output, pulsed bias output, or pulsed sweep output set to the channel. One single measurement can contain the maximum of 100000 measurement points for B2900 except B2901BL and 10000 points for B2901BL.

Once a single measurement starts, the data buffer is cleared, and the last single measurement result is stored in the buffer. The maximum data buffer is 100000 for B2900 except B2901BL and 10000 for B2901BL. The measurement result is displayed on the Single view, Dual view, Graph view, or Roll view. Also the last single measurement result can be listed and displayed on the Measure Result dialog box.

Auto Starts a repeat (continuous) measurement. If a repeat measurement is in progress, stops it. The repeat measurement is performed with the DC bias output of the Source value. And the measurement result is displayed on the Single view, Dual view, or Roll view. The repeat measurement result is not stored in the buffer.

The repeat measurement is performed with the following trigger setup. Settings of “Trigger parameters” are ignored.

- Acquire trigger (measurement trigger): Initiate
- ARM acquire count: Infinite
- ARM acquire source: AUTO (automatic internal)
- TRIGger acquire count (Measure Count) 100
- TRIGger acquire source (Measure Trigger): AUTO (automatic internal)
- TRIGger acquire timer period (Measure Period): 10 ms (this is automatically extended if the measurement is not completed.)
- Trigger delay (Source Delay = Measure Delay): 0 s

- Trigger output: Disable

View	Changes the display mode. See “Display and Assist Keys” on page 109 .
Cancel / Local	Cancels the setup operation if the instrument is in the local status. Returns the instrument to the local status if it is in the remote status.
On/Off	Used to enable or disable the SMU channel. Turns the channel off if it is in the output status even if it is in the remote status. One switch on 1-channel models, and two switches on 2-channel models. The switch turns green if the channel is enabled. The switch turns red if the channel is in the high voltage state.
Numeric/alpha keys	Used to enter the value for setup parameters such as the source output value, limit (compliance) value, and message, specified by the field pointer. The value can be changed if the field pointer is in the EDIT (green) status.
Rotary knob	If the field pointer is in the MOVE (blue) status, turning the knob moves the pointer. Pressing the knob fixes the pointer position and changes the pointer status to EDIT (green). If the field pointer is in the EDIT (green) status, turning the knob changes the value of the setup parameter specified by the pointer. Pressing the knob fixes the value and changes the pointer status to MOVE (blue). If the field pointer is in the EDIT (green) status on a setup field other than the Source field and the Limit (Compliance) field, turning the knob changes the setting value. The value is applied by pressing the knob. If the field pointer is in the EDIT (green) status on the Source or Limit field, turning the rotary knob changes the display value and updates the source channel output in real time. However, if the digit pointer is available, the source channel works depending on the setting of the real time update (the setting of the Immediate V/I Update by Knob field). For the Immediate V/I Update by Knob field, see “Display Preference Dialog Box” on page 159 . If the digit pointer is on a digit of a numeric value entry field, turning the knob changes the value of the digit. Note that changing the value from 9 to 0 or from 0 to 9 changes the value of the next digit. If the digit pointer is on the decimal point of a numeric value entry field, turning the knob moves the decimal point if the Immediate V/I Update by Knob setup is OFF.

Front Panel Reference
Hard Keys and Rotary Knob

- Left and right keys**
- If the field pointer is in the MOVE (blue) status, pressing the key moves the pointer.
 - If the field pointer is in the EDIT (green) status, pressing the key changes the value of the setup parameter specified by the pointer.
 - If the field pointer is in the EDIT (green) status on a numeric value entry field, pressing the key changes the pointer to the digit pointer.
 - If the digit pointer is on a digit of a numeric value entry field, pressing the key moves the pointer on the digits.

Display and Assist Keys

Keysight B2900 provides several display modes which depend on the model as shown below. The display mode is changed by the View key. Pressing the key changes the mode as shown below.

- B2901BL, B2910BL, and B2901B
Single → Graph → (return to Single)
- B2902B
Dual → Single for channel 1 → Single for channel 2 → Graph → (return to Dual)
- B2911B
Single → Graph → Roll → (return to Single)
- B2912B
Dual → Single for channel 1 → Single for channel 2 → Graph → Roll → (return to Dual)

For each display mode, five assist keys are available on the right side of the display. They are assigned to several softkeys such as Mode, Source, Limit, Measure, and More. The softkey assignment depends on the display mode.

For details of each display mode and assist keys, see the following sections.

- “Dual View”
- “Single View”
- “Graph View”
- “Roll View”
- “Status Information”

The status information is common for all display modes. It is displayed above the bottom softkeys associated with the function keys. This display area is also used to display system messages and error messages.

Dual View

Available on B2902B and B2912B. The upper half is for channel 1. The lower half is for channel 2. Each area displays the measurement results, source and measurement settings, and channel status. Most setup parameters can be edited on this display.

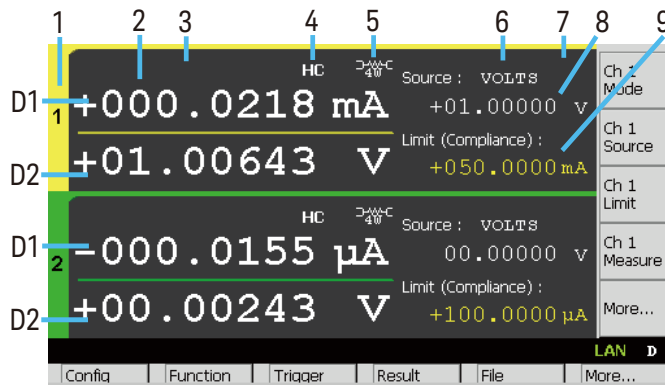

Display area

1. Channel number. 1 or 2.
 2. Latest measurement data
 3. Over voltage/current status indicator (OV or OC, red)
 4. High capacitance mode indicator (HC)
 5. Remote sensing (4-wire connection) status indicator
 6. Source function. VOLTS or AMPS.
 7. Source shape indicator. DC, pulse, sweep, or pulsed sweep. DC does not show the indicator.
 8. Source output value, 5½ digit resolution on B2902B, and 6½ digit resolution on B2912B
 9. Limit (Compliance) value. See [“Display Preference Dialog Box” on page 159](#) to set the V/I Limit for Each Polarity.
- D1. Primary measurement data. Turns orange if the data exceeds the Limit value.
- D2. Secondary measurement data. Turns orange if the data exceeds the Limit value.
- For the limit test, D2 displays PASS or FAIL instead of the measurement data.

Assist keys	In the following descriptions, <i>Ch n</i> indicates <i>Ch 1</i> or <i>Ch 2</i> .
<i>Ch n</i> Mode	<p>Changes the assist keys to VOLTS (V) and AMPS (I) used to select the source function.</p> <p>VOLTS (V) sets the voltage source.</p> <p>AMPS (I) sets the current source.</p>
<i>Ch n</i> Source	<p>Changes the assist keys to the unit keys shown below.</p> <p>μV, mV, and V for the voltage source</p> <p>pA, nA, μA, mA, and A for the current source</p> <p>First, enter or set the output value by using the numeric/alpha keys, rotary knob, and arrow keys. Then press one of the unit keys to apply the value.</p>
<i>Ch n</i> Limit	<p>Changes the assist keys to the unit keys shown below.</p> <p>pA, nA, μA, mA, and A for the current compliance</p> <p>μV, mV, and V for the voltage compliance</p> <p>First, enter or set the limit value by using the numeric/alpha keys, rotary knob, and arrow keys. Then press one of the unit keys to apply the value.</p>
<i>Ch n</i> Measure	<p>Changes the assist keys to AMPS (I), VOLTS (V), OHMS (R), and WATTS (P) used to select the measurement function.</p> <p>AMPS (I) sets the current measurement.</p> <p>VOLTS (V) sets the voltage measurement.</p> <p>OHMS (R) sets the resistance measurement.</p> <p>WATTS (P) sets the power measurement.</p> <p>Resistance data is given by $\text{Resistance} = V_{\text{meas}}/I_{\text{meas}}$.</p> <p>Power data is given by $\text{Power} = V_{\text{meas}} \times I_{\text{meas}}$.</p> <p>In the above formula, V_{meas} is the voltage measurement data, and I_{meas} is the current measurement data.</p> <p>For details on using resistance compensation, see “Resistance Compensation” on page 213.</p>

Front Panel Reference
Display and Assist Keys

More...

Changes the assist keys to *Ch 1* assist keys or *Ch 2* assist keys. *Ch 1* assist keys are effective for channel 1. *Ch 2* assist keys are effective for channel 2.

Single View

Displays the measurement results, source and measurement settings, and channel status. Most setup parameters can be edited on this display. The lower half displays the setup parameters selected by Assist keys 2.

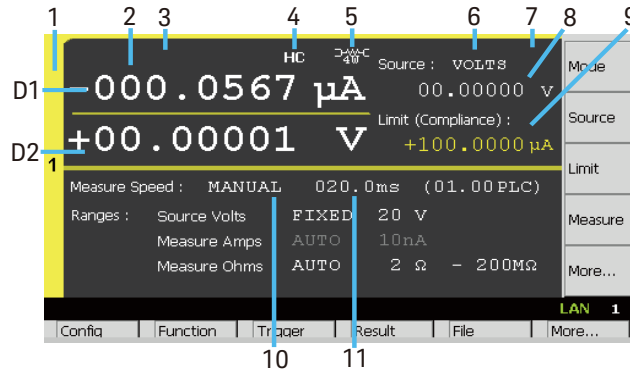

- Display area**
1. Channel number. 1 or 2.
 2. Latest measurement data
 3. Over voltage/current status indicator (OV or OC, red)
 4. High capacitance mode indicator (HC)
 5. Remote sensing (4-wire connection) status indicator
 6. Source function. VOLTS or AMPS.
 7. Source shape indicator. DC, pulse, sweep, or pulsed sweep. DC does not show the indicator. Pulse and pulsed sweep are not available for B2901BL and B2910BL.
 8. Source output value, 5½ digit resolution on B2901BL, B2910BL, B2901B, and B2902B, and 6½ digit resolution on B2911B and B2912B
 9. Limit (Compliance) value. See [“Display Preference Dialog Box” on page 159](#) to set the V/I Limit for Each Polarity.
 10. Measurement speed. AUTO, SHORT, MEDIUM, NORMAL, LONG, or MANUAL.
 11. Aperture time in seconds or PLC (power line cycle, number of power line cycles per a measurement). Only for the MANUAL speed.
- D1. Primary measurement data. Turns orange if the data exceeds the Limit value.

Front Panel Reference
Display and Assist Keys

D2. Secondary measurement data. Turns orange if the data exceeds the Limit value.

For the limit test, D2 displays PASS or FAIL instead of the measurement data. The limit test is not available for B2901BL.

Assist keys 1	Mode	Changes the assist keys to VOLTS (V) and AMPS (I) used to select the source function. VOLTS (V) sets the voltage source. AMPS (I) sets the current source.
	Source	Changes the assist keys to the unit keys shown below. μ V, mV, and V for the voltage source pA, nA, μ A, mA, and A for the current source First, enter or set the output value by using the numeric/alpha keys, rotary knob, and arrow keys. Then press one of the unit keys to apply the value.
	Limit	Changes the assist keys to the unit keys shown below. pA, nA, μ A, mA, and A for the current compliance μ V, mV, and V for the voltage compliance First, enter or set the limit value by using the numeric/alpha keys, rotary knob, and arrow keys. Then press one of the unit keys to apply the value.
	Measure	Changes the assist keys to AMPS (I), VOLTS (V), OHMS (R), and WATTS (P) used to select the measurement function. AMPS (I) sets the current measurement. VOLTS (V) sets the voltage measurement. OHMS (R) sets the resistance measurement. WATTS (P) sets the power measurement. Resistance data is given by $\text{Resistance} = V_{\text{meas}}/I_{\text{meas}}$. Power data is given by $\text{Power} = V_{\text{meas}} \times I_{\text{meas}}$. In the above formula, V_{meas} is the voltage measurement data, and I_{meas} is the current measurement data.

		For details on using resistance compensation, see “Resistance Compensation” on page 213 .
	More...	Changes the assist keys to Assist keys 2.
Assist keys 2	Speed	<p>Changes the assist keys to AUTO (1 PLC for 10 nA and 100 nA ranges, 0.01 PLC for other ranges), SHORT (0.01 PLC), MEDIUM (0.1 PLC), NORMAL (1 PLC), LONG (10 PLC), or MANUAL used to select the measurement speed. The aperture time is automatically set to the above values in parentheses. For the aperture time, see “Measurement Time” on page 202.</p> <p>For the MANUAL speed, the aperture time must be set to the right field in seconds or PLC (power line cycle, number of power line cycles per measurement). Move the field pointer to the one by using the arrow keys or rotary knob and press the knob to set the pointer to the EDIT mode. Enter or set the value by using the numeric/alpha keys, knob, or arrow keys, then press the knob or one of the unit keys to apply the value. For setting the seconds value, the following unit keys are available as assist keys.</p> <p>μs, ms, and s</p>
	Show Sweep	Displays the sweep setup parameters shown in “Sweep parameters” on page 117 , and changes the softkey label to <i>Hide Sweep</i> .
	Hide Sweep	Displays the range setup parameters shown in “Range parameters” on page 116 , and changes the softkey label to <i>Show Sweep</i> .
	Show Pulse	Displays the pulse setup parameters shown in “Pulse parameters” on page 121 , and changes the softkey label to <i>Hide Pulse</i> . Pulse is not available for B2901BL and B2910BL.
	Hide Pulse	Displays the range setup parameters shown in “Range parameters” on page 116 , and changes the softkey label to <i>Show Pulse</i> . Pulse is not available for B2901BL and B2910BL.
	Show Trigger	Displays the trigger setup parameters shown in “Trigger parameters” on page 122 , and changes the softkey label to <i>Hide Trigger</i> .

Hide Trigger Displays the range setup parameters shown in [“Range parameters” on page 116](#), and changes the softkey label to *Show Trigger*.

More... Changes the assist keys to Assist keys 1.

Softkey labels *Show XXXX* and *Hide XXXX* are switched by pressing the key.

Range parameters

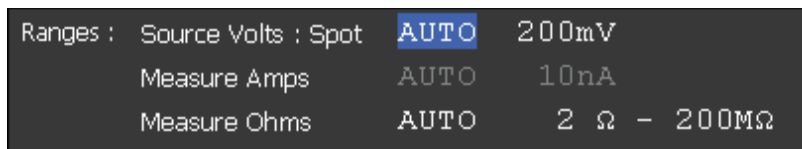

Ranges :	Source Volts :	Spot	AUTO	200mV
	Measure Amps		AUTO	10nA
	Measure Ohms		AUTO	2 Ω - 200MΩ

The following setup parameters are available. *Source* or *Measure XXXX* is decided by the source setting.

Source Volts:

Spot For the voltage source. Selects the range operation AUTO (automatic ranging) or FIXED (fixed range) for the constant voltage output and the source side voltage measurement.

Measure Amps For the voltage source. Selects the range operation AUTO or FIXED for the current measurement.

Source Amps:

Spot For the current source. Selects the range operation AUTO or FIXED for the constant current output and the source side current measurement.

Measure Volts For the current source. Selects the range operation AUTO or FIXED for the voltage measurement.

The right field is used to set the range value for the FIXED range operation, or the minimum range value for the AUTO range operation. For the available range values, see [“Output and Measurement Ranges” on page 51](#).

NOTE

If the range operation is AUTO, the channel automatically uses the range which provides the best resolution for the source output value or the measurement value.

NOTE

If the pulse output is ON and the range operation is AUTO, the measurement channel uses the minimum range which covers the Limit (Compliance) value.

Measure Ohms Selects the resistance measurement operation AUTO, FIXED, or V/I.

The right field is used to set the resistance measurement range value for the FIXED operation, or the minimum and maximum ranges for the AUTO operation. For the available range values, see [Table 2-9 on page 58](#). This setup field is not available for the V/I operation.

For AUTO and FIXED, the channel performs resistance measurement by using the current source and voltage measure condition automatically set by the resistance measurement range setting.

For V/I, the channel performs measurement by using the present source/measure condition, and the resistance value is given by V/I calculation.

Sweep parameters

```
Sweep Parameters :  LINEAR SINGLE
                    Start :  000.0000 mV  Stop : +1.500000 v
                    Points :    101      Step : +015.0000 mV
```

B2900 can be used as a sweep source, and supports the following sweep operations. The operation can be selected by using the assist keys displayed when the field pointer is in the EDIT (green) status on the Sweep Parameters field.

- LINEAR SINGLE: Sweep from start to stop in a linear incremental step
- LINEAR DOUBLE: Sweep from start to stop to start in a linear incremental step
- LOG SINGLE: Sweep from start to stop in a logarithmic incremental step
- LOG DOUBLE: Sweep from start to stop to start in a log incremental step
- LIST: Sweep of values defined in the List sweep setup list. See [“List sweep setup” on page 118](#).

The following setup parameters are available.

- Start** Sets the sweep start value.
- Stop** Sets the sweep stop value.

Points Sets the number of sweep steps.

Step Sets the sweep step value (incremental step value). Not available for the LOG and LIST sweep operations.

When the field pointer is in the EDIT (green) status on an entry field, the assist keys are changed to the unit keys as shown below.

- pA, nA, μ A, mA, and A for current sweep
- μ V, mV, and V for voltage sweep

For the range operation of the sweep source, see “Sweep Dialog Box” on page 135. The range parameters *Source Volt: Spot* and *Source Amps: Spot* are not effective for the AUTO and BEST range operations of the sweep source. They are effective for the constant source and FIXED range operation of the sweep source.

List sweep setup

When the field pointer is in the EDIT (green) status on the LIST sweep Start/Stop/Points field, the following assist keys are available for setting the list sweep source.

Edit Opens the List Sweep dialog box used to set the list sweep source.

Load Opens the Load List Sweep Data dialog box used to load a list sweep data from a USB memory connected to the front panel USB-A connector.

- List Sweep dialog box

This dialog box provides the following fields for setting the list sweep source. After the list is completed, press OK to apply the data and close the dialog box.

(data graph) Displays the shape of the list sweep output

(data list) Lists the data index in the left cell and the output value in the right cell.

When the pointer is in the MOVE status, the pointer can be moved in the crosswise direction. And pressing the knob changes the status to EDIT.

When the right cell is in the EDIT status, the output value can be entered to the cell.

When the left cell is in the EDIT status, the following assist keys are available for creating and scrolling the list. Then the pointer can be moved in the lengthwise direction. And pressing the knob changes the status to MOVE.

Append	Adds a line below. The same output value is entered into the right cell.
Insert	Adds a line above. The same output value is entered into the right cell.
Delete	Deletes the line.
Scroll -100	Moves the pointer to the maximum 100 points above.
Scroll +100	Moves the pointer to the maximum 100 points below.

Type	Data type V (voltage) or I (current)
CH	Channel number 1 or 2, only on 2-channel models
Points	Number of data points
Max	Maximum value
Min	Minimum value

- Load List Sweep Data dialog box

This dialog box provides the following fields for loading a list sweep data from a file stored on a USB memory. Highlight a file and press OK to load the data and close the dialog box.

(data graph)	Displays the shape of the list sweep data selected by the file list
(file list)	List of the list sweep data file
Path	Folder into which the list sweep data file is saved
Points	Number of data points
Max	Maximum value
Min	Minimum value

The following data can be loaded as the list sweep data.

- Comma separated value format, file extension csv

Front Panel Reference

Display and Assist Keys

For example,

0.0,0.1,0.2,0.3

- Carriage return or line feed separated value format, file extension txt

For example,

0.0

0.1

0.2

0.3

- Space separated value format in a line, file extension prn

For example,

0.0 0.1 0.2 0.3

Pulse parameters

```
Pulse :   ON      Peak : +05.00000 V
          Delay :  001.2000 ms
          Width :  025.0000 ms
```

B2900 except B2901BL and B2910BL can be used as a pulse source, and supports pulsed output and measurement. Pulse ON or OFF can be selected by using the assist keys displayed when the field pointer is in the EDIT (green) status on the Pulse field.

The following setup parameters are available.

- Peak** Sets the pulse peak value. Not available for the sweep source which sets the sweep output value to the pulse peak.
The pulse base value is set by the Source field in the upper half of the display area. See [“Single View” on page 113](#).
- Delay** Sets the pulse delay time. The pulse source changes the output level from the base value to the peak value when the delay time elapsed after trigger delay.
- Width** Sets the pulse width.

When the field pointer is in the EDIT (green) status on an entry field, the assist keys are changed to the unit keys as shown below.

µA, nA, µA, mA, and A for the peak current

µV, mV, and V for the peak voltage

µs, ms, s, and ks for the delay and width

NOTE

Channel operation by a trigger

If a channel is set to Pulse: ON, the channel outputs the pulse set to the Peak, Delay, and Width fields when it receives a trigger.

If a channel is set to Pulse: OFF, the channel applies the bias set to the Peak field when it receives a trigger. The settings of the Delay and Width fields are ignored.

The Peak field is corresponding to the [:SOUR]:<CURR[VOLT]>[:LEV]:TRIG[:AMPL] command.

Trigger parameters

Trigger :	Source	Measure
MANUAL	1	1
Count :	1	1
Delay :	0.000 μ s	0.000 μ s
Period :	0.000 μ s	0.000 μ s
Trigger :	AUTO	AUTO

The B2900 supports the following trigger types for triggering source output and measurement. They are effective for setting triggers easily.

The trigger type can be selected by using the assist keys displayed when the field pointer is in the EDIT (green) status on the Trigger field. See [Table 4-1](#) for the trigger types and the setup parameters.

AUTO	Automatic trigger type
SYNC	Synchronize trigger type
TIMER	Timer trigger type
MANUAL	Manual trigger type

The following setup parameters are available for setting the source output trigger (transient action) by using the Source column, and the measurement trigger (acquire action) by using the Measure column.

Count	Trigger count (number of triggers). 1 to 100000 or INF. (infinity) for B2901B, B2902B, B2911B, and B2912B; 1 to 100000 for B2910BL; and 1 to 10000 for B2901BL. This value is automatically set for the AUTO trigger type. For the other trigger type, set the number of triggers required for each source output and measurement properly. For example, set Source Count = Measure Count = 10 for the sweep measurement with 10 steps.
Delay	Sets the trigger delay time.
Period	Sets the trigger period.
Trigger	Selects the trigger source by using the assist key AUTO, BUS, TIMER, INT m (only for 2-channel model), LAN, or EXT n , where m is the integer 1 or 2, and n is an integer from between 1 and 14. See Table 4-1 for the trigger sources.

When the field pointer is in the EDIT (green) status on the Delay or Period field, the assist keys are changed to the unit keys: μ s, ms, s, and ks.

Table 4-1

Trigger Types and Setup Parameters

Type	Count	Delay	Period	Trigger
AUTO	set automatically	0 second	N.A.	AUTO
SYNC	entered value	entered value	N.A.	AUTO
TIMER	entered value	entered value	entered value	TIMER
MANUAL	entered value	entered value	entered value	selected value

Trigger = AUTO automatically selects the trigger source best suited for the present operating mode by using internal algorithms.

Trigger = BUS uses the remote interface trigger command such as GET, TRIGger, and *TRG.

Trigger = TIMER uses a signal internally generated every interval set by the *Period* parameter.

Trigger = INT1 or INT2 uses a signal from the internal bus 1 or 2, respectively.

Trigger = LAN uses the LXI trigger.

Trigger = EXT n uses a signal from the DIO pin n which is an output port of the Digital I/O D-sub connector on the rear panel. $n = 1$ to 14.

NOTE

Setting trigger parameters in detail

For details of the trigger system, see [Figure 6-8 on page 226](#).

The Single view provides the trigger types and parameters effective for setting triggers easily. If you want to set the trigger parameters in detail, select the MANUAL trigger type and use the Trigger Configuration dialog box opened by pressing the Trigger > Config function keys. See [“Trigger Key Group” on page 143](#).

The Single view does not contain the setup parameters for the arm layer, but contains the setup parameters for the trigger layer. The Single view setup is given priority over the trigger layer setup on the Trigger Configuration dialog box. Hence, the overlapped parameter values on the dialog box are ignored.

Graph View

Displays the graph for plotting the channel 1 and/or 2 measurement or math result. The Graph view can plot up to 5000 data.

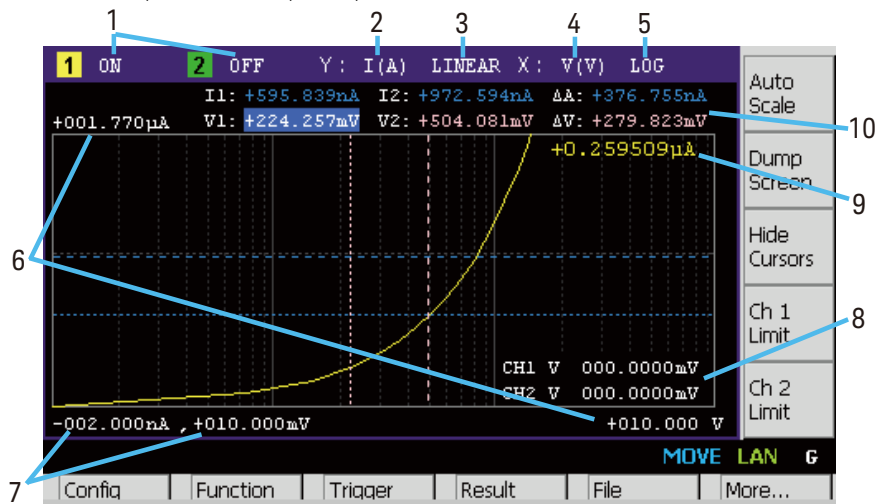

- Display area**
1. Graph display status ON or OFF. Only on 2-channel models. [n] is for channel *n*.
 2. Y-axis data type I (A), V (V), R (Ω), P (W), or MATH (see [Table 4-2](#))
 3. Y-axis scale LINEAR or LOG
 4. X-axis data type I (A), V (V), R (Ω), P (W), MATH, t (s), V1, or V2 (see [Table 4-2](#))
 5. X-axis scale LINEAR or LOG
 6. Graph maximum value
 7. Graph minimum value
 8. Channel 1 and/or 2 source output value, limit value, or none (controlled by the Ch *n* Source, Ch *n* Limit, or Hide Ch *n* assist key)
 9. Channel 1 and/or 2 Y-axis data at the active X-cursor position. ----- is displayed for the *no-data* position.
 10. Cursor data (controlled by the Show Cursors or Hide Cursors assist key)

First line	Positions and distance (e.g. I1, I2, ΔA) of Y-cursors 1 and 2
Second line	Positions and distance (e.g. t1, t2, Δt) of X-cursors 1 and 2

Table 4-2 X and Y Axes Data Types for Graph View

Data type	Assist key	Description
I (A)	AMPS (I)	Current measurement data
V (V)	VOLTS (V)	Voltage measurement data
R (Ω)	OHMS (R)	Resistance measurement data
P (W)	WATTS (P)	Power measurement data
MATH	MATH	Math result data
t (s)	TIME (t)	Time data. Only for the X-axis data.
V1	Ch 1 V (V1)	Only on 2-channel models. Voltage data of channel 1 or 2. Only for the X-axis data.
V2	Ch 2 V (V2)	

Assist keys	Auto Scale	Changes graph scale to fit the trace in the graph automatically.
	Dump Screen	Opens the File Selection (Dump Screen) dialog box which is used to save the screen dump as a JPEG file. The file can be saved onto a USB memory connected to the front panel USB-A connector. The file is saved with the specified name. If the file extension is not specified, “.jpg” is added automatically.
	Show Cursors	Displays the cursors (Y-cursors 1 and 2, X-cursors 1 and 2, and cursor data) and changes the softkey label to <i>Hide Cursors</i> .
	Hide Cursors	Hides the cursors and changes the softkey label to <i>Show Cursors</i> .
	Ch <i>n</i> Source	Displays the channel <i>n</i> source output value and changes the softkey label to <i>Ch n Limit</i> .
	Ch <i>n</i> Limit	Hides the channel <i>n</i> source output value and displays the limit value. Also changes the softkey label to <i>Hide Ch n</i> .
	Hide Ch <i>n</i>	Hides the channel <i>n</i> limit value and changes the softkey label to <i>Ch n Source</i> .

In the above descriptions, *Ch n* indicates *Ch 1* or *Ch 2*.

NOTE

If the number of data exceeds 5000

If the number of measurement data exceeds 5000, the Graph view and the Roll view plot the following data. Where n is integer, 1 to 5000.

Number of data is 5001 to 10000: $[2*(n-1)+1]$ th data

Number of data is 10001 to 25000: $[5*(n-1)+1]$ th data

Number of data is 25001 to 50000: $[10*(n-1)+1]$ th data

Number of data is 50001 to 100000: $[20*(n-1)+1]$ th data

Roll View

Available for B2911B and B2912B. Displays the time domain graph for plotting the channel 1 and/or 2 measurement data. See [Table 4-3](#) for the Y-axis data types. The Roll view can plot up to 5000 data.

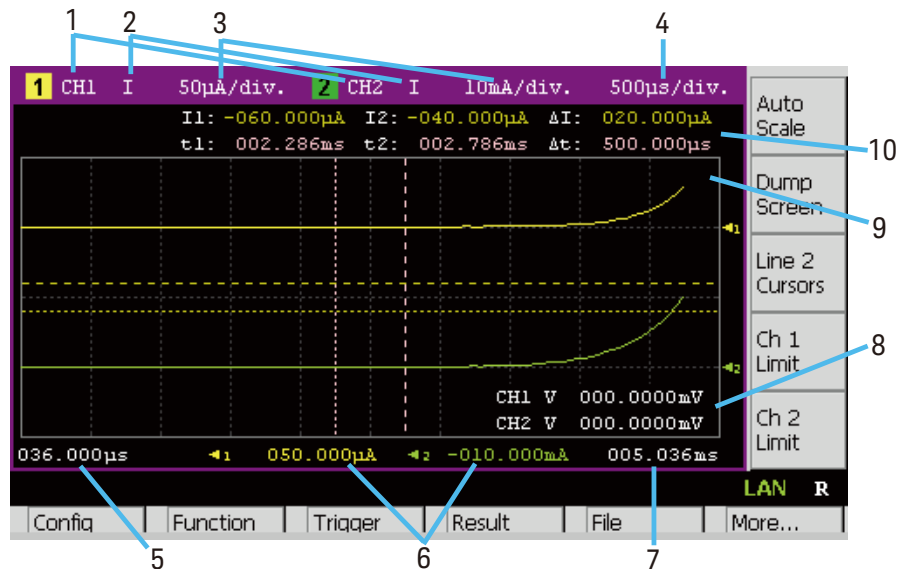

- Display area**
1. Displays status ON or OFF, on B2911B
Displays status Ch 1, Ch 2, or OFF, on B2912B
Two lines can be displayed on the graph. [1] indicates the graph setup for line 1. [2] indicates the graph setup for line 2.
 2. Y-axis data type I, V, R, or P.
 3. Y-axis scale per division A/div., V/div., Ω /div., or W/div.
 4. X-axis scale per division s/div.
 5. X-axis minimum value (minimum timestamp)
 6. Y-axis offset values for line 1 and 2
 7. X-axis maximum value (maximum timestamp)
 8. Channel 1 and/or 2 source output value, limit value, or none (controlled by the Ch *n* Source, Ch *n* Limit, or Hide Ch *n* assist key)
 9. Channel 1 and/or 2 Y-axis data at the active X-cursor position. ----.---- is displayed for the *no-data* position.
 10. Cursor data (controlled by the Line 1 Cursors, Line 2 Cursors, or Hide Cursors assist key)
 - First line** Positions and distance (e.g. I1, I2, ΔA) of Y-cursors 1 and 2
 - Second line** Positions and distance (e.g. t1, t2, Δt) of X-cursors 1 and 2

Table 4-3 Y-Axis Data Types for Roll View

Data type	Assist key	Description
I	AMPS (I)	Current measurement data
V	VOLTS (V)	Voltage measurement data
R	OHMS (Ω)	Resistance measurement data
P	WATTS (P)	Power measurement data

Assist keys	Auto Scale	Changes graph scale to fit the trace in the graph automatically.
	Dump Screen	Opens the File Selection (Dump Screen) dialog box which is used to save the screen dump as a JPEG file. The file can be saved onto a USB memory connected to the front panel USB-A connector. The file is saved with the specified name. If the file extension is not specified, “.jpg” is added automatically.
	Line 1 Cursors	Displays the cursors (Y-cursors 1 and 2, X-cursors 1 and 2, and cursor data) for line 1, and changes the softkey label to <i>Line 2 Cursors</i> .
	Line 2 Cursors	Displays the cursors (Y-cursors 1 and 2, X-cursors 1 and 2, and cursor data) for line 2, and changes the softkey label to <i>Hide Cursors</i> .
	Hide Cursors	Hides the cursors and changes the softkey label to <i>Line 1 Cursors</i> .
	Ch <i>n</i> Source	Displays the channel <i>n</i> source output value and changes the softkey label to <i>Ch <i>n</i> Limit</i> .
	Ch <i>n</i> Limit	Hides the channel <i>n</i> source output value and displays the limit value. Also changes the softkey label to <i>Hide Ch <i>n</i></i> .
	Hide Ch <i>n</i>	Hides the channel <i>n</i> limit value and changes the softkey label to <i>Ch <i>n</i> Source</i> .

In the above descriptions, *Ch n* indicates *Ch 1* or *Ch 2*.



Status Information

The status information is common for all display modes. It is displayed above the bottom softkeys associated with the function keys.



Table 4-4

Status Indicator

Label	Color	Description
AUTO	white	Trigger auto. Automatic trigger is enabled now.
ARM	white	Trigger active. Trigger system is active now.
HV	yellow	High voltage. Output voltage setting is over ± 42 V.
		Channel 1 floating status. Channel 1 is not grounded.
		Channel 2 floating status. Channel 2 is not grounded.
REM	white	Remote. Instrument is in the remote state.
		Local lockout. Instrument is in the local lockout (LLO) status.
ERR	white	Error. At least one error is detected.
EDIT	green	Edit mode. The field specified by the pointer can be edited. Not in the move mode.
MOVE	blue	Move mode. The field pointer can be moved. Not in the edit mode.
LAN	green or red	LXI LAN status indicator. Green indicates normal LAN status. Red indicates abnormal condition. Blinking indicates the LAN identification status.
D	white	Display mode: Dual view
1	white	Display mode: Single view for channel 1
2	white	Display mode: Single view for channel 2
G	white	Display mode: Graph view
R	white	Display mode: Roll view

Function Keys

Keysight B2900 has six function keys below the front panel display, and provides the following softkeys.

Function keys 1	Config	SMU configuration setup. Displays the softkeys for setting several functions of the SMU. See “Config Key Group” on page 132.
	Function	Math, limit test, and trace function setup. Displays the softkeys for setting these functions. See “Function Key Group” on page 138.
	Trigger	Trigger configuration and control. Displays the softkeys for setting and controlling the trigger system. See “Trigger Key Group” on page 143.
	Result	Measurement, limit test, and trace result display. Displays the softkeys for displaying these results. See “Result Key Group” on page 147.
	File	File operation. Displays the softkeys for saving and loading a file. See “File Key Group” on page 150.
	More...	Changes the function keys to Function keys 2.
Function keys 2	Program	Program configuration and control. Displays the softkeys for setting and controlling the program memory. See “Program Key Group” on page 151.
	I/O	I/O setup. Displays the softkeys for setting the I/O interfaces. See “I/O Key Group” on page 152.
	Display	Display setup. Displays the softkeys for setting the display functions. See “Display Key Group” on page 158.
	System	System setup. Displays the softkeys used for several system setups. See “System Key Group” on page 160.
	LED Demo	For demonstration. If an LED is connected between the High Force and Low Force terminals, pressing OK starts the LED IV measurement demonstration.

More... Changes the function keys to Function keys 1.

Config Key Group

Pressing the Config key displays the following softkeys for setting several functions of the SMU.

Source	Displays the following softkeys for setting the SMU source operation.
Connection	Channel operation and connection setup. See “Output Connection Dialog Box” on page 134.
Filter	Output filter setup. See “Output Filter Dialog Box” on page 133.
Sweep	Sweep source detail setup. See “Sweep Dialog Box” on page 135.
Measure	Displays the following softkeys for setting the SMU measurement operation.
R Compen	<p>Resistance compensation ON or OFF. See “Resistance Compensation” on page 213.</p> <p>On a 1-channel model, pressing this key displays the ON and OFF keys used to set the resistance compensation on or off.</p> <p>On a 2-channel model, pressing this key displays the ALL, Ch 1, and Ch 2 keys. They are used to specify the channel for setting the resistance compensation on or off.</p> <p>ALL specifies channels 1 and 2.</p> <p>Ch 1 specifies channel 1 only.</p> <p>Ch 2 specifies channel 2 only.</p>
Ranging	Measurement range detail setup. See “Ranging Dialog Box” on page 136.
Common	Displays the following softkeys for setting the SMU’s miscellaneous function.
Wait	Source and measurement wait time setup. See “Wait Control Dialog Box” on page 137.

- Group** Only on 2-channel models. Channel grouping ON or OFF. If this function is ON, the channels perform synchronous channel operation. The present setting is indicated by an asterisk on the softkey label.
- Save, Recall** Saves/recalls all setup information of the B2900. Five storage areas are available in the built-in non-volatile memory (NVRAM) for this purpose.
- Press the Save or Recall softkey to display the softkeys #1, #2, #3, #4, and #5 used for selecting the storage area. Press a softkey to save or recall the setup information.

Output Filter Dialog Box

This dialog box provides the following parameters for setting the output filter.

- Ch** Only on 2-channel models. Channel 1 (Ch 1) or 2 (Ch 2)
This field specifies the channel set by this dialog box.
- Filter State** Output filter ON or OFF
Set the filter ON to obtain clean source output without spikes and overshooting. Note, however, that using a filter may increase the SMU settling time.
- Automatic Filter** Automatic filter ON or OFF
Set the function ON to automatically set the output filter which provides the best filter characteristics and cutoff frequency.
- Time Constant** Filter time constant, 5 μ s to 500 μ s

Output Connection Dialog Box

This dialog box provides the following parameters for setting the channel operation and connection.

Ch	Only on 2-channel models. Channel 1 (Ch 1) or 2 (Ch 2) This field specifies the channel set by this dialog box.
Sensing Type	2-wire connection (2-WIRE) or 4-wire connection (4-WIRE). Set 4-WIRE for remote sensing.
Low Terminal State	Low sense terminal connection. Grounded (GROUND) or floating (FLOAT)
High Capacitance Mode	High capacitance mode ON or OFF Set the mode to ON to perform high capacitive load measurements. See “High Capacitance Mode” on page 212 .
Over Voltage/Current Protection	Over voltage or current protection ON or OFF Set the function ON to turn off the channel output automatically and immediately when it reaches its compliance.
Output-Off State	High impedance (HIGH Z), normal (NORMAL), or zero volt (ZERO) This is the source setup condition after output off. See Table 6-1 on page 210 .
Auto Output-On	Automatic output on function ON or OFF Set the function ON to turn on the channel output automatically just before the trigger system is initiated by the SCPI command (not by front panel operation).
Auto Output-Off	Automatic output off function ON or OFF Set the function ON to turn off the channel output automatically and immediately when all trigger system changes the status from busy to idle.

Sweep Dialog Box

This dialog box provides the following parameters for setting details of the sweep source operation.

Ch	Only on 2-channel models. Channel 1 (Ch 1) or 2 (Ch 2) This field specifies the channel set by this dialog box.
Sweep Ranging	Ranging mode used for the sweep source operation. BEST, AUTO, or FIXED. See Table 4-5 on page 135 .
Sweep Direction	UP (start to stop direction) or DOWN (stop to start direction)
Output after Sweep	The value the source channel applies after it completes the sweep output START VALUE (START): The source channel changes the output to the DC output value just before applying the sweep output start value. END VALUE (END): The source channel keeps the output value when the sweep output is stopped.

Table 4-5

Ranging Mode used for Sweep Source Operation

	Description
BEST	In the linear sweep mode, the sweep source channel automatically uses the minimum range which covers the whole sweep output. In the log sweep mode, the sweep source channel automatically uses the range which provides the best resolution for each sweep step output.
AUTO	The sweep source channel automatically changes and sets the range which provides the best resolution to apply the source output for each sweep step.
FIXED	The sweep source channel sets the range specified by the range parameter <i>Source Volts: Spot</i> or <i>Source Amps: Spot</i> . See "Range parameters" on page 116 .

Ranging Dialog Box

This dialog box provides the following parameters for setting details of the auto ranging operation for measurements.

- Ch** Only on 2-channel models. Channel 1 (Ch 1) or 2 (Ch 2)
 This field specifies the channel set by this dialog box.
- Current Auto Ranging** Current measurement auto range operation. NORMAL, SPEED, or RESOLUTION (RESOLN). See [Table 4-6](#).
- Voltage Auto Ranging** Voltage measurement auto range operation. NORMAL, SPEED, or RESOLUTION (RESOLN). See [Table 4-6](#).
- Threshold** Sets the *rate* value of the formula shown below.

Table 4-6

Measurement Auto Range Operation

Description	
NORMAL	Supports basic operation and downward changing operation described below
SPEED	Supports basic operation and upward and downward changing operations described below
RESOLN	Supports basic operation and upward changing operation described below

- Basic operation
 The channel automatically sets the range which provides the best resolution in performing the measurement.
- Upward changing operation
 If measured data $\geq \text{value1}$, the range changes up after the measurement.
 $\text{value1} = \text{measurement range} \times \text{rate} / 100$
- Downward changing operation
 If measured data $\leq \text{value2}$, the range changes down immediately.
 $\text{value2} = \text{measurement range} \times \text{rate} / 1000$

Wait Control Dialog Box

This dialog box provides the following parameters for setting the source and measurement wait time.

The source wait time is defined as the time the source channel cannot change the output after the start of a DC output or the trailing edge of a pulse.

The measurement wait time is defined as the time the measurement channel cannot start measurement after the start of a DC output or the trailing edge of a pulse.

Ch Only on 2-channel models. Channel 1 (Ch 1) or 2 (Ch 2)

This field specifies the channel set by this dialog box.

State Wait time ON or OFF

Automatic Automatic wait time ON or OFF

Gain and Offset Parameters for calculating the wait time. See the following formula.

- If State = ON and Automatic = ON:
$$\text{wait time} = \text{Gain} \times \text{initial wait time} + \text{Offset}$$
- If State = ON and Automatic = OFF:
$$\text{wait time} = \text{Offset}$$
- If State = OFF:
$$\text{wait time} = 0$$

The initial wait time is automatically set by the instrument, and cannot be changed.

Function Key Group

Pressing the Function key displays the following softkeys for setting the math, limit test, and trace functions.

- Math** Math function setup. See [“Math Expression Dialog Box” on page 138](#).
- Limit Test** Displays the following softkeys for setting the limit test function. The limit test is not available for B2901BL.
- Composite** Composite limit test setup. See [“Composite Limit Test Setup Dialog Box” on page 139](#).
- Limits** Limit test setup. See [“Limit Test Setup Dialog Box” on page 140](#).
- Trace** Trace function setup. See [“Trace Buffer Setup Dialog Box” on page 141](#).

Math Expression Dialog Box

This dialog box provides the following parameters for setting the math function. If the math function is ON, the measurement data can be calculated by using the specified math expression.

- Ch** Only on 2-channel models. Channel 1 (Ch 1) or 2 (Ch 2)
This field specifies the channel set by this dialog box.
- Status** Math function ON or OFF
- Unit String** Unit for the calculation result of the math expression

The available math expressions are listed in the area below the Unit String field. This area can be used to select the math expression for data calculation. To select a math expression, highlight the name in this area.

The data calculation is effective for data measured after the math function is set by this dialog box. The calculation result can be displayed on the dialog box opened by using the Result key group. See [“Result Key Group” on page 147](#).

Math expressions can be defined by using the SCPI commands while the B2900 is in the remote mode.

For the predefined math expressions, see “Predefined Math Expressions” on page 214.

Composite Limit Test Setup Dialog Box

This dialog box provides the following parameters for setting the limit test. The limit test is not available for B2901BL.

Ch	Only on 2-channel models. Channel 1 (Ch 1) or 2 (Ch 2) This field specifies the channel set by this dialog box.
Limit Test	Composite limit test ON or OFF
Mode	Operation mode. GRADING (GRADE) or SORTING (SORT) GRADING: Grading mode. See Figure 6-5 for the operation. SORTING: Sorting mode. See Figure 6-6 for the operation.
Auto Clear	Automatic clear of the composite limit test result ON or OFF If this parameter is ON, the composite limit test results and the DIO lines are automatically cleared.
Update	Only for the GRADING mode. Test result output timing, IMMEDIATE (IMM.) or END. See “Immediate?” shown in Figure 6-5. IMMEDIATE: Output after every test (Immediate? Yes) END: Output after the last test (Immediate? No)
Offset Cancel	Offset cancel ON or OFF If this parameter is ON, the data for the limit test judgement will be as follows. Data for judgement = measurement data - offset value
Offset	Offset value used for the offset cancel, -9.999999E+20 to +9.999999E+20
Pass Pattern	Bit pattern for the limit test <i>pass</i> state. For the GRADING mode.
Fail Pattern	Bit pattern for the limit test <i>fail</i> state. For the SORTING mode.
GPIO Pins	Displays the DIO pins assigned to the bit pattern output. To set the pins, use the :CALC:DIG:BIT command.
/BUSY	DIO pin assigned to the BUSY (busy) signal output

/SOT DIO pin assigned to the SOT (start of test) signal input

/EOT DIO pin assigned to the EOT (end of test) signal output

For the DIO pin assignment, see [“Using Digital I/O” on page 101](#).

DIO pins assigned to the GPIO Pins, /BUSY, /SOT, or /EOT must be set to the DIGITAL I/O function by using the [DIO Configuration Dialog Box](#).

NOTE

Values of GPIO Pins, /BUSY, /SOT, and /EOT

0 to 14 (integer). Numbers 1 to 14 indicate the DIO pins 1 to 14, respectively. 0 indicates that it is not used.

For GPIO Pins, multiple continuous pins are assigned. For example, “1, 2, 3, 4” indicates that the DIO pins 1 to 4 are assigned. Then LSB is DIO pin 1.

Limit Test Setup Dialog Box

This dialog box provides the following parameters for setting the limit test, which is a part of the composite limit test. The limit test is not available for B2901BL.

Ch Only on 2-channel models. Channel 1 (Ch 1) or 2 (Ch 2)

This field specifies the channel set by this dialog box.

Feed Data Type of data used for the pass/fail judgement of the limit test. MATH, VOLTS, AMPS, or OHMS.

MATH: Calculation result data of math expression

VOLTS: Voltage measurement data (Vmeas)

AMPS: Current measurement data (Imeas)

OHMS: Resistance data (= Vmeas/Imeas)

For details on using resistance compensation, see [“Resistance Compensation” on page 213](#).

Test Index Index of limit test. No. 1 to 12.

The index numbers 1 to 12 are associated with the bin numbers 1 to 12. See [“Limit Test Result Dialog Box” on page 148](#).

Limit Test Limit test ON or OFF

Function Test mode. COMPLIANCE (COMP.) or LIMIT

	COMPLIANCE: Compliance check
	LIMIT: Limit test
Pass Pattern	Bit pattern for the limit test <i>pass</i> state. For the SORTING mode.
Fail on	Only for compliance check. OUT or IN. Fail on = IN judges limit test failure if the channel goes into the compliance state. Fail on = OUT judges limit test failure if the channel comes out of the compliance state.
Fail Pattern	Only for compliance check. Bit pattern for the limit test <i>fail</i> state.
Up Pattern	Not available for compliance check. Bit pattern for the <i>failed-by-exceeding-upper-limit</i> state. Used for the GRADING mode.
Up Limit	Not available for compliance check. Upper limit for the pass/fail judgement. Used for the GRADING mode.
Low Pattern	Only for limit test. Bit pattern for the <i>failed-by-exceeding-lower-limit</i> state. Used for the GRADING mode.
Low Limit	Only for limit test. Lower limit for the pass/fail judgement. Used for the GRADING mode.

Bit pattern is sent to the DIO pins specified by the GPIO Pins field on the Composite Limit Test Setup dialog box.

Trace Buffer Setup Dialog Box

This dialog box provides the following parameters for setting the trace function. The data specified by the Feed Data parameter can be stored in the trace buffer if the Buffer Control parameter is NEXT. The maximum data size is specified by the Buffer Size parameter. See [Figure 6-7 on page 221](#) for the trace buffer.

Ch	Only on 2-channel models. Channel 1 (Ch 1) or 2 (Ch 2) This field specifies the channel set by this dialog box.
Feed Data	Type of data placed in the trace buffer. SENSE, MATH, or LIMIT SENSE: Measurement result data

Front Panel Reference
Function Key Group

MATH: Calculation result data of math expression

LIMIT: Limit test data

The data contains the voltage measurement data, current measurement data, resistance measurement data, source output setting data, calculation result data, limit test data, time data, or status data selected by using the Format keys of the I/O key group. See [“I/O Key Group” on page 152](#).

Buffer Control

Trace buffer control mode. NEVER or NEXT

NEVER: Disables the write operation to the trace buffer.

NEXT: Enables the write operation until buffer full.

Buffer full will change the mode to NEVER.

Buffer Size

Size of the trace buffer. 1 to 100000 data for B2910BL, B2901B, B2902B, B2911B, and B2912B; 1 to 10000 data for B2901BL.

Trigger Key Group

Pressing the Trigger key displays the following softkeys for setting the trigger parameters in detail and controlling the trigger system. See [Figure 6-8 on page 226](#).

- Config** Opens a dialog box. See [“Trigger Configuration Dialog Box” on page 144](#).
- Initiate** Displays the softkeys for selecting the device action to initiate (to go to the arm layer of the trigger system). See [Table 4-7](#).
- Abort** Displays the softkeys for selecting the device action to abort (to return to the idle state of the trigger system). See [Table 4-7](#).
- Immediate** Displays the following softkeys for selecting the arm layer or trigger layer for sending the immediate trigger.
 - Trigger** Selects the trigger layer.
 - Arm** Selects the arm layer.
 Selecting the layer displays the softkeys for selecting the device action to send the immediate trigger. See [Table 4-7](#).

Table 4-7 Softkeys to Select Device Action and Channel

Softkey label	Description
ALL	Selects the transient and acquire device actions.
Trans.	Selects the transient (source output) device action only.
Acq.	Selects the acquire (measurement) device action only.
On a 1-channel model, selecting the device action executes Initiate, Abort, or Immediate for the specified device action.	
On a 2-channel model, selecting the device action displays the following softkeys for selecting the channel.	
ALL	Selects channels 1 and 2.
Ch 1	Selects channel 1 only.

Softkey label	Description
Ch 2	Selects channel 2 only.

Selecting the channel executes Initiate, Abort, or Immediate for the specified device action of the specified channel.

Trigger Configuration Dialog Box

This dialog box is used to set the trigger parameters in detail. Note that the overlapped parameter values are ignored and replaced with the settings made on the Single view. See [“Trigger parameters” on page 122](#).

Ch	Only on 2-channel models. Channel 1 (Ch 1) or 2 (Ch 2) This field specifies the channel set by this dialog box.
Layer	Specifies the layer or device action set by this dialog box. ARM: Arm layer TRIGGER: Trigger layer ACTION: Device action For ACTION, the available parameters are Ch, Layer, Action, and Trigger Output.
Action	Specifies the device action type set by this dialog box. TRANS.: Transient (source output) device action ACQ.: Acquire (measurement) device action
Count	Count for the action specified by the Ch, Layer, and Action parameters. 1 to 100000 or INF. (infinity) for B2901B, B2902B, B2911B, and B2912B; 1 to 10000 for B2901BL; and 1 to 100000 for B2910BL.
Bypass	Bypass ON or OFF Bypass = ON enables the bypass only for the first passage to the event detector for the action specified by the Ch, Layer, and Action parameters. Bypass = OFF disables the bypass.

Trigger Source	Event for the action specified by the Ch, Layer, and Action parameters. AUTO, BUS, TIMER, INT1, INT2, LAN, EXT1, EXT2, EXT3, EXT4, EXT5, EXT6, EXT7, EXT8, EXT9, EXT10, EXT11, EXT12, EXT13, or EXT14. See Table 4-8 .
Period	Only for the TIMER event. Interval of the TIMER event for the action specified by the Ch, Layer, and Action parameters, 20 μ s to 100000 s for B2901B and B2902B; 10 μ s to 100000 s for B2911B and B2912B; 200 μ s to 100000 s for B2901BL; and 50 μ s to 100000 s for B2910BL.
Trigger Delay	Delay time for the action specified by the Ch, Layer, and Action parameters, 0 to 100000 s
Trigger Output	Trigger output ON or OFF Trigger output terminal. Internal bus (INT1, INT2), LAN port (LAN), or a digital I/O pin EXT n ($n = 1$ to 14) If this parameter is ON, B2900 sends an output trigger when it changes the trigger state for the action specified by the Ch, Layer, and Action parameters. See Figure 6-8 on page 226 . For using a digital I/O pin, it is necessary to set function of the pin, output trigger polarity, type, pulse width, and so on. See “DIO Configuration Dialog Box” on page 155 and “Using Digital I/O” on page 101 .

Table 4-8

Trigger Source

Trigger Source	Description
AUTO	Trigger source best suited for the present operating mode is automatically selected by the internal algorithms.
BUS	Remote interface trigger command such as GET, TRIGger, and *TRG
TIMER	Signal internally generated every interval set by the Period field
INT1 or INT2	Signal from the internal bus 1 or 2

Front Panel Reference
Trigger Key Group

Trigger Source	Description
LAN	LXI trigger specified by the :ARM[:ACQ]:TRAN]:SOUR:LAN and :TRIG[:ACQ]:TRAN]:SOUR:LAN commands
EXT n	Signal from the DIO pin n , which is an I/O port of the Digital I/O D-sub connector on the rear panel. $n = 1$ to 14

Result Key Group

Pressing the Result key displays the following softkeys for displaying the measurement, limit test, and trace results.

- Measure** Displays the measurement result. See “[Measure Result Dialog Box](#)” on page 147.
- Limit Test** Displays the limit test result. See “[Limit Test Result Dialog Box](#)” on page 148. The limit test is not available for B2901BL.
- Trace** Displays the trace result. See “[Trace Statistical Result Dialog Box](#)” on page 149.

Measure Result Dialog Box

This dialog box is used to display the last single (one shot) measurement result stored in the data buffer. The maximum data is 100000 data for B2900 except B2901BL and 10000 data for B2901BL.

This dialog box provides the following GUI for displaying the measurement result. The result data is shown in the index and data table below the Type field. Also, the data is plotted in the graph area above the Points fields.

- Ch** Only on 2-channel models. Channel 1 (Ch 1) or 2 (Ch 2)
This field specifies the channel of the data to display.
- Type** Type of data to display. AMPS, VOLTS, OHMS, WATTS, MATH, or TIME
 - AMPS: Current measurement data
 - VOLTS: Voltage measurement data
 - OHMS: Resistance data given by $\text{Resistance} = \text{Vmeas}/\text{Imeas}$
 - WATTS: Power data given by $\text{Power} = \text{Vmeas} \times \text{Imeas}$
 - MATH: Calculation result data of math expression
 - TIME: Time data

In the above formula, Vmeas is the voltage measurement data, and Imeas is the current measurement data.

For details on using resistance compensation, see [“Resistance Compensation” on page 213](#).

Points	Number of data points
Max.	Y-axis maximum value of the graph
Min.	Y-axis minimum value of the graph

Limit Test Result Dialog Box

This dialog box provides the following GUI for displaying the limit test result. The result data is shown in the data list area below the Length field. The limit test is not available for B2901BL.

Ch Only on 2-channel models. Channel 1 (Ch 1) or 2 (Ch 2)
This field specifies the channel of the data to display.

Length Data length

The limit test data contains the following information.

(aaaaa) BIN: bb DATA: +c.ccccccE+dd

(aaaaa) Data index **aaaaa**

BIN: Bin number **bb** (**01** to **12**)

The bin numbers 1 to 12 are associated with the index numbers 1 to 12. See [“Limit Test Setup Dialog Box” on page 140](#).

If the limit test data is out of the bins, **00** is set for the GRADING mode and **15** is set for the SORTING mode.

DATA: Limit test data **+c.ccccccE+dd**

Trace Statistical Result Dialog Box

This dialog box provides the following GUI for displaying the trace statistical result. The result data is displayed in the Mean, Std. Dev., Min., and Max. fields.

Ch	Only on 2-channel models. Channel 1 (Ch 1) or 2 (Ch 2) This field specifies the channel of the data to display.
Feed	Always SENSE
Element	Type of data to display. AMPS, VOLTS, or OHMS AMPS: Current measurement data VOLTS: Voltage measurement data OHMS: Resistance data given by $\text{Resistance} = V_{\text{meas}}/I_{\text{meas}}$ In the above formula, V_{meas} is the voltage measurement data, and I_{meas} is the current measurement data. For details on using resistance compensation, see “Resistance Compensation” on page 213 .
Length	Data length
Mean	Mean value
Std. Dev.	Standard deviation
Min.	Minimum value
Max.	Maximum value

File Key Group

Pressing the File key displays the following softkeys for saving a file on and loading a file from a USB memory connected to the front panel USB-A connector.

Save Displays the following softkeys for saving a file. Pressing a softkey displays the File Selection dialog box. See [“File Selection Dialog Box” on page 150](#).

Measure Saves a measurement data file.

Math Saves a math result data file.

Limit Test Saves a limit test result data file.

Trace Saves a trace buffer data file.

Config Saves a system setting data file.

Load Displays the following softkey for loading a file. Pressing the softkey displays the File Selection dialog box. See [“File Selection Dialog Box” on page 150](#).

Config Loads a system setting data file.

License Loads a license file.

NOTE

The license file enables the functions secured by license.

File Selection Dialog Box

This dialog box provides the following GUI for saving or loading a file.

Path Folder name for saving or loading a file

File Name File name to save or load

The files and folders saved in the specified folder are listed in the area between the Path field and the File Name field. This area can be used for selecting a file by highlighting its name.

For saving a system setting file, if the file extension is not specified, “.sta” is added automatically. For saving the other data file, “.csv” is added automatically.

Program Key Group

Pressing the Program key displays the following softkeys for setting and controlling the program memory.

The program memory can be defined by using the SCPI commands while the B2900 is in the remote mode.

- Catalog** Displays the Program Catalog dialog box which lists the programs saved in the program memory. This dialog box is also used to specify the memory program to use. To select a memory program, highlight its name in this list.
- View** Displays the Program View dialog box which shows the program code of the specified program.
- Variable** Displays the Variable dialog box which lists the variables used in the memory programs. Available index is 1 to 100.
- Control** Displays the following softkeys for controlling the operation of the program memory.
- | | |
|-----------------|---|
| Run | Starts the specified memory program. |
| Pause | Pauses the execution of the memory program. |
| Step | Starts the step execution of the specified memory program. |
| Stop | Stops the execution of the memory program. |
| Continue | Continues the execution of the memory program presently paused. |

I/O Key Group

Pressing the I/O key displays the following softkeys for setting the I/O interfaces.

- Format** Displays the softkeys for setting the data output format. See “[Data Output Format](#)” on page 153.
- LAN** Displays the following softkeys for managing the LAN interface.
- Config** Displays the LAN Configuration dialog box used to set the configuration of the LAN interface. See “[LAN Configuration Dialog Box](#)” on page 155.
 - Status** Displays the LAN Status dialog box which displays the status of the LAN interface.
 - Reset** Resets all of the LAN connections.
 - Defaults** Sets the LAN settings to the factory default settings.
- Pressing the Reset softkey or the Defaults softkey displays a confirmation dialog box. Press the OK softkey to confirm the specified action, or press the Cancel/Local key to cancel the action.
- USB** Displays the USB Status dialog box.
- Easy File Access** File access function setup ON (enable) or OFF (disable). When this is set to ON, restart this instrument. When you use this function, connect this instrument to a PC using a USB cable. See “[File Access Function \(Easy File Access\)](#)” on page 230. This function is not available for B2901BL and B2910BL.
 - Text display field** Displays the VISA USB connect string.
Example: `USB0::10893::38145::MY12345678::0::INSTR`
- GPIB** Displays the GPIB Configuration dialog box used to set the GPIB address of the B2900. This dialog also displays the VISA GPIB connect string.
Example: `GPIB0::23::INSTR`
- DIO** Displays the following softkeys for managing the Digital I/O interface.

- Config** Displays the DIO Configuration dialog box used to set the configuration of the Digital I/O interface. See “[DIO Configuration Dialog Box](#)” on page 155.
- R/W** Displays the DIO Read/Write dialog box used to read or write a value set to the Digital I/O interface. See “[DIO Read/Write Dialog Box](#)” on page 156.

Data Output Format

Pressing the Format softkey displays the following softkeys for setting the format and elements of the output data.

- Measure** Displays the Format (Measure) dialog box used to set the elements of the measurement data output. See “[Format \(Measure\) Dialog Box](#)” on page 154.
- Math/Limit** Displays the Format (Math/Limit) dialog box used to set the elements of the math result data output and the limit test result data output. See “[Format \(Math/Limit\) Dialog Box](#)” on page 154.
- Trace** Displays the Format (Trace) dialog box used to set the elements of the trace data output. See “[Format \(Trace\) Dialog Box](#)” on page 154.
- Data Type** Displays the following softkeys for specifying the data output format. The present setting is indicated by an asterisk on the softkey label.

ASCII	ASCII format
REAL32	IEEE-754 single precision format, 4-byte
REAL64	IEEE-754 double precision format, 8-byte
- Data Swap** Displays the following softkeys for enabling or disabling the byte swap for the IEEE-754 precision format data output. The present setting is indicated by an asterisk on the softkey label.

OFF	Disables the byte swap. Normal byte order.
ON	Enables the byte swap. Reverse byte order.

If Data Swap = ON, the byte order is reversed. Byte 1 to byte 4 are sent in the order of byte 4 to byte 1 for the IEEE-754 single precision format, and byte 1 to byte 8 are sent in the order of byte 8 to byte 1 for the IEEE-754 double precision format.

Format (Measure) Dialog Box

This dialog box provides the following parameters for setting the elements of the measurement data output.

Voltage	Voltage data output ON or OFF
Current	Current data output ON or OFF
Resistance	Resistance data output ON or OFF
Source	Source data output ON or OFF
Time	Time data output ON or OFF
Status	Status data output ON or OFF

Format (Math/Limit) Dialog Box

This dialog box provides the following parameters for setting the elements of the math result data output and the limit test result data output.

Data	Result data output ON or OFF
Time	Time data output ON or OFF
Status	Status data output ON or OFF

Format (Trace) Dialog Box

This dialog box provides the following parameters for setting the elements of the trace statistical data output.

Ch	Only on 2-channel models. Channel 1 (Ch 1) or 2 (Ch 2) This field specifies the channel set by this dialog box.
Data	Trace data. Selects one from the following data elements. MEAN Mean value STD.DEV. Standard deviation MIN. Minimum value MAX. Maximum value PK-PK Peak to peak value
Timestamp	Timestamp data format. Selects one from the following selections.

ABSOLUTE	Absolute value (ABS.). Returns the incremental value for the first timestamp data.
DELTA	Delta value (DELTA). Returns the incremental value for the previous timestamp data.

LAN Configuration Dialog Box

This dialog box provides the following parameters for setting the configuration of the LAN interface.

mDNS	mDNS (multicast DNS) status ON or OFF
IP Address Config.	IP address configuration. AUTO or MANUAL AUTO configuration uses the DHCP server.
IP Address	IP address of this instrument, used for the MANUAL IP address configuration
Subnet	Subnet mask, used for the MANUAL IP address configuration
Gateway	IP address of gateway, used for the MANUAL IP address configuration
DNS Server Config.	DNS server configuration. AUTO or MANUAL
DNS Server	IP address of DNS server, primary and secondary, used for the MANUAL DNS server configuration
Hostname	Host name of this instrument
WINS Server	IP address of WINS server, primary and secondary

DIO Configuration Dialog Box

This dialog box provides the following parameters for setting the configuration of the Digital I/O interface.

Pin #	Digital I/O pin number, 1 to 14 This field specifies the pin set by this dialog box.
--------------	---

Function	Function of the specified pin of the Digital I/O interface, digital signal input/output (DIGITAL I/O), digital signal input (DIGITAL IN), trigger output (TRIGGER OUT), trigger input (TRIGGER IN), or high voltage state (HIGH VOLTAGE LAMP, HI-VOLT LAMP, only for pin 14) If Function is set to HIGH VOLTAGE LAMP, other setup parameters on this dialog box is ignored.
Polarity	Polarity of the input/output function. Positive (POSITIVE, POS.) or negative (NEGATIVE, NEG.)
Output Trigger Type	Type of output trigger, edge (EDGE) or level (LEVEL)
Output Trigger Timing	Timing of the output trigger, after action (arm, trigger, and device action) (AFTER), before action (BEFORE), or both (BOTH)
Output Pulse Width	Pulse width of the output trigger, 10 μ s to 10 ms

For more information about the trigger function, see [“Trigger Key Group” on page 143](#).

DIO Read/Write Dialog Box

This dialog box provides the following parameters for reading or writing a value set to the Digital I/O interface.

Format	Format of the value set to the Mask Value field and the Value field, binary (BIN), decimal (DEC), or hexadecimal (HEX)
Mask Value	Mask value which indicates the pattern of the un-used bits of the Digital I/O interface The READ assist key is used to read the mask value presently set to the Digital I/O interface. The WRITE assist key is used to set the specified mask value to the Digital I/O interface.
Value	Value set to the Digital I/O interface The READ assist key is used to read the value presently set to the Digital I/O interface.

The WRITE assist key is used to write the specified value to the Digital I/O interface.

Display Key Group

Pressing the Display key displays the following softkeys for setting the display functions. The present setting is indicated by an asterisk on the softkey label.

Remote	Displays the following softkeys for enabling or disabling the front panel display when the B2900 is in the remote mode.
OFF	Disables the front panel display. Effective for fast operation.
ON	Enables the front panel display.
Color	Displays the following softkeys for specifying the display color set.
Set 1	Sets the color set 1.
Set 2	Sets the color set 2.
Zoom	Displays the following softkeys for enabling or disabling the display zoom.
OFF	Disables the zoom. Normal display.
ON	Enables the zoom. Only the measured data is displayed. Zoom-in can be canceled by pressing the Zoom Out assist key.
	In the zoom-in state, setup information is not displayed, and the measurement result is zoomed. Then,
	<ul style="list-style-type: none">• the Dual view displays the primary measurement data with a large font, and the secondary measurement data for each channel with a small font.• the Single view displays the primary and secondary measurement data with a large font.
Digits	Displays the following softkeys for specifying the data display resolution.
4	Sets 3½ digit resolution.
5	Sets 4½ digit resolution.
6	Sets 5½ digit resolution.
7	Sets 6½ digit resolution.

- Pref.** Displays the Display Preference dialog box. See “[Display Preference Dialog Box](#)” on page 159.

Display Preference Dialog Box

This dialog box is used to set the following parameters. The settings are saved to the non-volatile memory.

- **V/I Limit for Each Polarity**

Selects the Limit (Compliance) setup operation.

ON Individual setup ON
Positive and negative limits can be set individually.

OFF Individual setup OFF
 \pm Limit value is set.

- **Immediate V/I Update by Knob**

Selects the channel operation when the Source value or the Limit (Compliance) value is changed by using the digit pointer and the rotary knob.

ON Real time update ON
Turning the rotary knob changes the display value and updates the channel output in real time.

OFF Real time update OFF
Turning the rotary knob just changes the display value. The value is applied to the channel output by pressing the rotary knob.

- **Restore Trigger Mode on Local**

Stores the trigger mode setting on entering GP-IB remote state, ON or OFF.

ON Saves the trigger mode setting in the non-volatile memory on entering GPIB remote state and restores the saved trigger mode setting when returning to GPIB local mode.

OFF Disables this function.

System Key Group

Pressing the System key displays the following softkeys used for several system setups.

Error Displays the following softkeys to view or clear errors.

Log Displays the Error Log dialog box which displays the SCPI errors.

Clear Clears the error buffer immediately.

Reset Initializes the B2900.

Press the Reset softkey to display a confirmation dialog box and press one of the following softkeys to perform the initialization. To cancel the initialization and close a confirmation dialog box, press the Cancel/Local key.

Display Initializes the display settings.

H/W Initializes the hardware settings.

ALL Initializes all settings.

Cal/Test Displays the following softkeys for performing self-calibration or self-test.

Self-Cal Performs self-calibration.

Self-Test Performs self-test.

Pressing the softkey displays a confirmation dialog box. Press the OK softkey to start self-calibration or self-test, or the Cancel/Local key to cancel.

PLC Displays the following softkeys to specify the power line frequency. The present setting is indicated by an asterisk on the softkey label.

50 Hz Specifies the power line frequency 50 Hz.

60 Hz Specifies the power line frequency 60 Hz.

Timestamp Displays the following softkeys to clear timestamp.

Clear	Clears the timestamp. Pressing this softkey displays the confirmation dialog box. Press the OK softkey to clear the timestamp, or the Cancel/Local key to cancel.										
Auto CLR	Displays the following softkeys for setting the automatic clear of the timestamp. The present setting is indicated by an asterisk on the softkey label. <table border="0" style="margin-left: 20px;"> <tr> <td>OFF</td> <td>Disables the automatic clear of the timestamp.</td> </tr> <tr> <td>ON</td> <td>Enables the automatic clear of the timestamp.</td> </tr> </table>	OFF	Disables the automatic clear of the timestamp.	ON	Enables the automatic clear of the timestamp.						
OFF	Disables the automatic clear of the timestamp.										
ON	Enables the automatic clear of the timestamp.										
Start-up	Displays the System Start-up dialog box which provides the following setup parameters. <table border="0" style="margin-left: 20px;"> <tr> <td>Power-on State</td> <td>RST, RCL0, RCL1, RCL2, RCL3, or RCL4</td> </tr> <tr> <td></td> <td>The power-on state can be selected from the factory default reset condition (RST) and user conditions RCL0, RCL1, RCL2, RCL3, and RCL4 which can be defined by using the *SAV 0, *SAV 1, *SAV 2, *SAV 3, and *SAV 4 commands, respectively, while the B2900 is in the remote mode.</td> </tr> <tr> <td>Power-on Program</td> <td>Power-on program execution ON or OFF</td> </tr> <tr> <td></td> <td>If this parameter is ON, the power-on program is automatically executed when the B2900 is turned on.</td> </tr> <tr> <td></td> <td>The power-on program can be defined by using the :PROG:PON:COPY command while the B2900 is in the remote mode.</td> </tr> </table>	Power-on State	RST, RCL0, RCL1, RCL2, RCL3, or RCL4		The power-on state can be selected from the factory default reset condition (RST) and user conditions RCL0, RCL1, RCL2, RCL3, and RCL4 which can be defined by using the *SAV 0, *SAV 1, *SAV 2, *SAV 3, and *SAV 4 commands, respectively, while the B2900 is in the remote mode.	Power-on Program	Power-on program execution ON or OFF		If this parameter is ON, the power-on program is automatically executed when the B2900 is turned on.		The power-on program can be defined by using the :PROG:PON:COPY command while the B2900 is in the remote mode.
Power-on State	RST, RCL0, RCL1, RCL2, RCL3, or RCL4										
	The power-on state can be selected from the factory default reset condition (RST) and user conditions RCL0, RCL1, RCL2, RCL3, and RCL4 which can be defined by using the *SAV 0, *SAV 1, *SAV 2, *SAV 3, and *SAV 4 commands, respectively, while the B2900 is in the remote mode.										
Power-on Program	Power-on program execution ON or OFF										
	If this parameter is ON, the power-on program is automatically executed when the B2900 is turned on.										
	The power-on program can be defined by using the :PROG:PON:COPY command while the B2900 is in the remote mode.										
Sound	Displays the following softkeys to enable or disable the beep and sound. The present setting is indicated by an asterisk on the softkey label. <table border="0" style="margin-left: 20px;"> <tr> <td>OFF</td> <td>Disables the beep and sound.</td> </tr> <tr> <td>ON</td> <td>Enables the beep and sound.</td> </tr> </table>	OFF	Disables the beep and sound.	ON	Enables the beep and sound.						
OFF	Disables the beep and sound.										
ON	Enables the beep and sound.										
Language	Displays the following softkeys for specifying the B2900 remote control command set. The present setting is indicated by an asterisk on the softkey label. <table border="0" style="margin-left: 20px;"> <tr> <td>Default</td> <td>Specifies the default command set which supports all B2900 functions.</td> </tr> </table>	Default	Specifies the default command set which supports all B2900 functions.								
Default	Specifies the default command set which supports all B2900 functions.										

Front Panel Reference
System Key Group

2400 Specifies the conventional command set designed for using the existing programs which you created to control existing instruments, such as Series 2400 by Keithley Instruments, Inc.

Script Not effective.

The default command set and the conventional command set are available.

Info. Displays the following softkeys.

Revision Displays the Revision dialog box which displays the model number, serial number, and firmware revision of the B2900.

Date/Time Displays the Date and Time dialog box which is used to view or set the date and time.

Update Used for firmware update.

Demo. Performs demonstration. Pressing this softkey displays a confirmation dialog box. Press the OK softkey to start demonstration, or the Cancel/Local key to cancel.

Factory Returns the B2900 to the condition when it is shipped from the factory. Pressing this softkey displays a confirmation dialog box. Press the OK softkey to start the initialization, or the Cancel/Local key to cancel.

5 Front Panel Operations

Basic Operations	165
To Use Functions Other Than Measurement	167
To Set Source Output	174
To Execute Measurement	185
To Use Math Function	191
To Execute Limit Test	192
To Use Trace Buffer	196
To Use Program Memory	198

This chapter explains how to use the Keysight B2900.

NOTE

Turning the instrument on or off

Press the standby switch. When the power is on, the LED below the switch is turned green.

NOTE

Setting the instrument to local mode

Press the Cancel/Local key.

The front panel keys are available when the instrument is in local mode.

NOTE

Enabling or disabling the channel

Press the On/Off switch.

The channel status is indicated by the lighting status of the switch as follows.

Off: The channel is disabled.

Green: The channel is enabled.

Red: The channel is in the high voltage state.

NOTE

Starting measurement

Press the Trigger key. According to the setting conditions, the single (one shot) measurement is performed with the DC bias output, staircase sweep output, pulsed bias output, or pulsed sweep output.

Press the Auto key. The repeat (continuous) measurement is performed with the DC bias output (of the Source value).

Basic Operations

Use the field pointer to specify a setup field in the setup screen. The field pointer can take the following states. Change the status as needed during the setup of B2900.

MOVE status Highlighted in blue. You can move the pointer from field to field.

EDIT status Highlighted in green. You can change the value of the current field.

To Change the Setting in a Field

1. If the field pointer is in the EDIT status, press the rotary knob. The pointer status is changed to MOVE.
2. Turn the rotary knob or press the arrow keys to move the field pointer.
3. Move the field pointer to the item to be changed and press the rotary knob. The pointer status is changed to EDIT.
4. Enter a value or character by pressing the numeric/alpha keys, turning the rotary knob, or pressing the arrow keys. Press the rotary knob to fix the setting value. The pointer status is changed to MOVE.

Or press the assist key corresponding to the setting value to fix the setting value. The pointer status is changed to MOVE.

NOTE

Digit pointer

In numeric value entry fields such as the Source and Limit (Compliance) fields, you can specify only one digit to change its value.

When the field pointer is in the EDIT status (i.e., all digits in the entry field are highlighted in green), pressing the arrow keys changes the pointer to the digit pointer, which points only one digit in the entry field. In this status, the following operations are allowed.

The arrow keys are used to move the pointer.

The numeric/alpha keys and rotary knob are used to change the value of the digit indicated by the pointer.

When the pointer is on the decimal point, turning the knob moves the decimal point if the real time update (Immediate V/I Update by Knob) is OFF.

NOTE

Channel operation when using the rotary knob

If the field pointer is in the EDIT (green) status on the Source or Limit (Compliance) field, turning the knob changes/updates the setting value of the source channel in real time.

Channel operation when using the knob and the digit pointer depends on the setting of the real time update (Immediate V/I Update by Knob).

- Real time update ON
Setting value is applied to the channel immediately.
 - Real time update OFF
Setting value is not applied immediately. It is applied to the channel by pressing the knob.
-

To Change the Settings on a Dialog Box

1. Set the items on the dialog box in the same way as described in [“To Change the Setting in a Field” on page 165](#).
2. To apply the settings, press Apply.
To apply all settings and close the dialog box, press OK.
To cancel the setting change, press the Cancel/Local key instead of pressing Apply.

To Use Functions Other Than Measurement

This section describes the following miscellaneous operations other than the source output and measurement functions.

- “To Set Power Line Frequency”
- “To Return to Factory Shipment Condition”
- “To Apply Initial Settings”
- “To Set Beeper”
- “To Set Date and Time”
- “To Perform Self-Test”
- “To Perform Self-Calibration”
- “To Set Operations at Power On”
- “To Display Error Message”
- “To Clear Error Buffer”
- “To Clear Timestamp”
- “To Set Automatic Clear of Timestamp”
- “To Display Firmware Revision”
- “To Display License Information”
- “To Set GPIB Address”
- “To Set Remote Control Command Set”
- “To Set Remote Display Mode”
- “To Save/Recall All Setup Information”
- “To Enable/Disable Media Transfer Protocol for Easy File Access”
- “To Enable/Disable the Function to Restore the Trigger Mode Settings on the Local State”
- “To Enable/Disable Source/Limit Real Time Update by Using Digit Pointer and Knob”

To Set Power Line Frequency

1. Press the More > System > PLC function keys.
2. Press 50 Hz or 60 Hz. To cancel the setting change, press the Cancel/Local key.

To Return to Factory Shipment Condition

1. Press the More > System > More > Factory function keys.
2. Press OK to apply. To cancel the operation, press the Cancel/Local key.

To Apply Initial Settings

1. Press the More > System > Reset function keys.
The Confirmation dialog box and the following function keys appear.

Display	Initializes the display settings.
H/W	Initializes the hardware settings.
ALL	Initializes all settings.
2. Press one of these keys. To cancel the operation, press the Cancel/Local key.

To Set Beeper

1. Press the More > System > More > Sound function keys.
2. To enable the beeper, press ON. To disable it, press OFF. To cancel the setting change, press the Cancel/Local key.

To Set Date and Time

1. Press the More > System > More > Info. function keys.
2. Press Date/Time.
The Date and Time dialog box opens.
3. Set the date and time.
4. To apply the settings, press Apply.
To apply the settings and close the dialog box, press OK.
To cancel the setting change, press the Cancel/Local key.

To Perform Self-Test

1. Press the On/Off switch and confirm that the switch is turned off.
2. Disconnect test leads and cables from the channel terminals.
3. Press the More > System > Cal/Test > Self-Test function keys.
The Confirmation dialog box opens.
4. Press OK to perform the self-test. To cancel the operation, press the Cancel/Local key.

To Perform Self-Calibration

The self-calibration must be performed after warming-up of 60 minutes.

1. Press the On/Off switch and confirm that the switch is turned off.
2. Disconnect test leads and cables from the channel terminals.
3. Press the More > System > Cal/Test > Self-Cal function keys.
The Confirmation dialog box opens.
4. Press OK to perform the self-calibration. To cancel the operation, press the Cancel/Local key.

To Set Operations at Power On

1. Press the More > System > More > Start-up function keys.
The System Start-up dialog box opens.
2. See [“Start-up” on page 161](#) to set each parameter.

To Display Error Message

1. Press the More > System > Error function keys.
2. Press Log.
The error message is displayed in the Error Log dialog box.
3. Press OK to close the dialog box.

To Clear Error Buffer

1. Press the More > System > Error function keys.
2. To clear the error buffer, press Clear. To cancel the operation, press the Cancel/Local key.

To Clear Timestamp

1. Press the More > System > Timestamp function keys.
2. Press Clear. The Confirmation dialog box opens.
3. To perform the operation, press OK. To cancel the operation, press the Cancel/Local key.

To Set Automatic Clear of Timestamp

1. Press the More > System > Timestamp function keys.
2. Press Auto CLR.
3. To enable the automatic clear, press ON. To disable it, press OFF. To cancel the setting change, press the Cancel/Local key.

To Display Firmware Revision

1. Press the More > System > More > Info. function keys.
2. Press Revision.
The revision information is displayed in the Revision dialog box.
Press OK to close the dialog box.

To Display License Information

Perform the following steps to display the license applied to the B2900.

1. Press the More > System > More > Info. function keys.
2. Press Revision.
The license information is displayed in the Revision dialog box.
Press OK to close the dialog box.

NOTE

License is required for each instrument (every serial number) to use the functions secured by license.

To Set GPIB Address

1. Press the More > I/O function keys.
2. Press GPIB.
The GPIB Configuration dialog box opens.
3. Set the GPIB address.
4. To apply the settings, press Apply.
To apply the settings and close the dialog box, press OK.
To cancel the setting change, press the Cancel/Local key.

To Set Remote Control Command Set

1. Press the More > System > More > Language function keys.
2. To use the default command set, press Default. To use the conventional command set, press 2400.
3. If the command set is changed, the Confirmation dialog box opens. To apply the setting change, press OK. To cancel the setting change, press the Cancel/Local key.

To Set Remote Display Mode

1. Press the More > Display function keys.
2. Press Remote.
3. To enable the screen display in remote mode, press ON. To disable it, press OFF. To cancel the setting change, press the Cancel/Local key.

To Save/Recall All Setup Information

This function saves/recalls all setup information of the B2900. For this function, five storage areas are available in the built-in non-volatile memory (NVRAM).

To save the setup information, do the following steps.

1. Press the Config > Save function keys.
2. Press a function key #1, #2, #3, #4, or #5 corresponding to the storage area.

To recall the setup information, do the following steps.

1. Press the Config > Recall function keys.
2. Press a function key #1, #2, #3, #4, or #5 corresponding to the storage area which stores the setup information to recall.

To Enable/Disable Media Transfer Protocol for Easy File Access

For details on this function, see [“File Access Function \(Easy File Access\)” on page 230](#). This function is not available for B2901BL and B2910BL.

1. Press the More > I/O > USB function keys. The USB Status dialog box opens.
2. Set the Easy File Access field to ON (enable) or OFF (disable).
3. To apply the settings and close the dialog box, press OK.

To cancel the setting change, press the Cancel/Local key.

Changing the setting needs rebooting the B2900.

To Enable/Disable the Function to Restore the Trigger Mode Settings on the Local State

For details on this function, see [“Display Preference Dialog Box” on page 159](#).

1. Press the More > Display > Pref. function keys. The Display Preference dialog box opens.
2. Set the Restore Trigger Mode on Local field to ON (enable) or OFF (disable).
3. To apply the settings and close the dialog box, press OK.

To cancel the setting change, press the Cancel/Local key.

To Enable/Disable Source/Limit Real Time Update by Using Digit Pointer and Knob

For details on this function, see [“Display Preference Dialog Box” on page 159](#).

1. Press the More > Display > Pref. function keys. The Display Preference dialog box opens.
2. Set the Immediate V/I Update by Knob field to ON (enable) or OFF (disable).
3. To apply the settings and close the dialog box, press OK.
To cancel the setting change, press the Cancel/Local key.

To Set Source Output

This section describes the following source output operations.

- “To Set Source Output Mode”
- “To Apply DC Voltage/Current”
- “To Stop Source Output”
- “To Set Limit (Compliance) Value”
- “To Set Output Range”
- “To Set Pulse Output”
- “To Set Sweep Output”
- “To Set List Sweep Output”
- “To Set Source Output Trigger Parameters”
- “To Set Source Wait Time”
- “To Set Output Filter”
- “To Set Connection Type”
- “To Set Low Terminal State”
- “To Enable or Disable High Capacitance Mode”
- “To Enable or Disable Over Voltage/Current Protection”
- “To Specify Output-Off Status”
- “To Enable or Disable Automatic Output-On Function”
- “To Enable or Disable Automatic Output-Off Function”
- “To Set Ranging Mode of the Sweep Source”
- “To Set Sweep Direction”
- “To Set Source Output Value after Sweep”

To Set Source Output Mode

1. For the Single view, press the Mode assist key. For the Dual view, press the Ch1 Mode or Ch2 Mode assist key.

The field pointer moves to the Source mode setup field.

2. Press VOLTS (V) for the voltage output or AMPS (I) for the current output.

To Apply DC Voltage/Current

1. For the Single view, press the Source assist key. For the Dual view, press the Ch1 Source or Ch2 Source assist key.

The field pointer moves to the Source value setup field.

2. Enter the output value by using the numeric/alpha keys, rotary knob, and arrow keys.
3. Press the rotary knob or assist key to fix the setting value.
4. Press the On/Off switch for channel 1 or 2 (Ch 1 or Ch 2).

The channel starts the specified voltage/current output. While the switch is turned green, the channel continues the output and changes the value immediately if it is changed.

To Stop Source Output

1. Press the On/Off switch for channel 1 or 2 (Ch 1 or Ch 2).

The output and measurement are stopped and the switch turns off.

To Set Limit (Compliance) Value

For details on this function, see [“Limit/Compliance” on page 200](#).

1. For the Single view, press the Limit assist key. For the Dual view, press the Ch1 Limit or Ch2 Limit assist key.

The field pointer moves to the Limit (Compliance) field.

2. Enter the limit value by using the numeric/alpha keys, rotary knob, and arrow keys.
3. Press the rotary knob or assist key to fix the setting value.

NOTE

The Limit (Compliance) value can be set to both positive and negative directions individually by setting ON to the V/I Limit for Each Polarity field on the Display Preference dialog box. See [“Display Preference Dialog Box” on page 159](#).

To Set Output Range

For details on this function, see [“Ranging Mode” on page 201](#) and [“Range parameters” on page 116](#).

1. Press the View key to display the Single view. If the Range parameters are not displayed, press the Hide XXXX assist key.
2. Move the field pointer to the Source Volts: Spot (voltage source range) or Source Amps: Spot (current source range) field.
3. Press the rotary knob to change the pointer status to EDIT.
4. Press AUTO to set the auto range operation or FIXED to set the fixed range operation. The pointer status is changed to MOVE.
5. Move the field pointer to the range value setup field (on the right side of the Source Volts: Spot or Source Amps: Spot field).
6. Press the rotary knob to change the pointer status to EDIT.
7. Press an assist key to set the following value.

For the auto range operation: Minimum range of the range operation

For the fixed range operation: Range used for source output

To Set Pulse Output

For details on this function, see [“Pulse Output” on page 204](#). This function is not available for B2901BL and B2910BL.

1. Press the View key to display the Single view.
2. Press the Show Pulse assist key to display the Pulse parameters. For details on the parameters, see [“Pulse parameters” on page 121](#).
3. Move the field pointer to the Pulse field.
4. Press the rotary knob to change the pointer status to EDIT.
5. Press the ON assist key. The pointer status is changed to MOVE.

6. Move the field pointer to the pulse parameter setup field (Peak, Delay, or Width).
7. Press the rotary knob to change the pointer status to EDIT.
8. Enter the pulse peak value (Peak), delay time (Delay), or pulse width (Width).
9. Press the rotary knob or assist key to fix the setting value.
10. Repeat steps 6 to 9 for all parameters.

NOTE

Applying the pulse voltage/current

Press the On/Off switch to start the Source value output. The Source value is used as the pulse base value.

Press the Trigger key to perform the specified pulse output and measurement.

To Set Sweep Output

For details on the sweep output function, see [“Sweep parameters” on page 117](#) and [“Sweep Output” on page 206](#).

The following procedure sets the staircase sweep output.

To set the pulsed sweep output, it is necessary to set the staircase sweep output and the pulse output. For details on setting the pulse output, see [“To Set Pulse Output” on page 176](#). The pulse output is not available for B2901BL and B2910BL.

1. Press the View key to display the Single view.
2. Press the Show Sweep assist key to display the Sweep parameters.
3. Move the field pointer to the Sweep Parameters field.
4. Press the rotary knob to change the pointer status to EDIT.
5. Press the LINEAR SINGLE, LINEAR DOUBLE, LOG SINGLE, or LOG DOUBLE assist key to select the relevant sweep operation. The pointer status is changed to MOVE.
6. Move the field pointer to the sweep parameter setup field (Start, Stop, Points, or Step).
7. Press the rotary knob to change the pointer status to EDIT.
8. Enter the sweep start value (Start), sweep stop value (Stop), number of sweep steps (Points), or sweep step value (Step).

9. Press the rotary knob or assist key to fix the setting value.
10. Repeat steps 6 to 9 for all parameters.

NOTE

Applying the sweep voltage/current

Press the On/Off switch to start the Source value output.

Press the Trigger key to perform the specified sweep output and measurement.

To Set List Sweep Output

For details on this function, see [“List Sweep” on page 207](#).

1. Press the View key to display the Single view.
2. Press the Show Sweep assist key to display the Sweep parameters.
3. Move the field pointer to the Sweep Parameters field.
4. Press the rotary knob to change the pointer status to EDIT.
5. Press the LIST assist key. The pointer status is changed to MOVE.
6. Move the field pointer to the sweep parameter setup field (Start, Stop, or Points).
7. Press the rotary knob to change the pointer status to EDIT.
8. Press the Edit assist key. The List Sweep dialog box opens.
9. Set the list sweep source using the List Sweep dialog box. For details, see [“List sweep setup” on page 118](#).
10. To apply the settings, press Apply.
 - To apply the settings and close the dialog box, press OK.
 - To cancel the setting change, press the Cancel/Local key.

NOTE

Load assist key

If you press the Load assist key instead of the Edit assist key in step 8, the Load List Sweep Data dialog box opens to allow you to load list sweep data from a USB memory.

For details, see [“List sweep setup” on page 118](#).

NOTE

Applying the list sweep voltage/current

Press the On/Off switch to start the Source value output.

Press the Trigger key to perform the specified list sweep output and measurement.

To Set Source Output Trigger Parameters

For details on this function, see [“Trigger System” on page 224](#) and [“Trigger parameters” on page 122](#).

1. Press the View key to display the Single view.
2. Press the Show Trigger assist key to display the Trigger parameters.
3. Move the field pointer to the Trigger field.
4. Press the rotary knob to change the pointer status to EDIT.
5. Press the AUTO, SYNC, TIMER, or MANUAL assist key to set the trigger type. The pointer status is changed to MOVE.
6. Move the field pointer to the trigger parameter setup field (Count, Delay, Period, or Trigger in the Source column).
7. Press the rotary knob to change the pointer status to EDIT.
8. Enter the trigger count (Count), trigger delay time (Delay), trigger period (Period), or trigger source (Trigger).
9. Press the rotary knob or assist key to fix the setting value.
10. Repeat steps 6 to 9 for all parameters.

NOTE

If you want to set the trigger parameters in detail, select the MANUAL trigger type and use the Trigger Configuration dialog box opened by pressing the Trigger > Config function keys. See [“Trigger Key Group” on page 143](#).

To Set Source Wait Time

For details on this function, see [“Measurement Time” on page 202](#) and [“Wait Control Dialog Box” on page 137](#).

1. Press the Config > Common > Wait function keys.

Front Panel Operations To Set Source Output

The Wait Control dialog box opens.

2. Set each parameter in the Source column.
3. To apply the settings, press Apply.

To apply the settings and close the dialog box, press OK.

To cancel the setting change, press the Cancel/Local key.

To Set Output Filter

For details on this function, see [“Output Filter” on page 208](#) and [“Output Filter Dialog Box” on page 133](#).

1. Press the Config > Source > Filter function keys.

The Output Filter dialog box opens.

2. Set each parameter.
3. To apply the settings, press Apply.

To apply the settings and close the dialog box, press OK.

To cancel the setting change, press the Cancel/Local key.

To Set Connection Type

For details on this function, see [“2-Wire Connections or 4-Wire Connections” on page 82](#).

1. Press the Config > Source > Connection function keys.

The Output Connection dialog box opens.

2. In the Ch field, set the channel to which the setting change is applied.
3. Set 2-WIRE or 4-WIRE in the Sensing Type field.
4. To apply the settings, press Apply.

To apply the settings and close the dialog box, press OK.

To cancel the setting change, press the Cancel/Local key.

To Set Low Terminal State

For details on this function, see [“Floating” on page 83](#).

1. Press the Config > Source > Connection function keys.

The Output Connection dialog box opens.

2. In the Ch field, set the channel to which the setting change is applied.
3. Set GROUNDED or FLOATING in the Low Terminal State field.
4. To apply the settings, press Apply.

To apply the settings and close the dialog box, press OK.

To cancel the setting change, press the Cancel/Local key.

To Enable or Disable High Capacitance Mode

For details on this function, see [“High Capacitance Mode” on page 212](#).

1. Press the Config > Source > Connection function keys.

The Output Connection dialog box opens.

2. In the Ch field, set the channel to which the setting change is applied.
3. Set ON (enable) or OFF (disable) in the High Capacitance Mode field.
4. To apply the settings, press Apply.

To apply the settings and close the dialog box, press OK.

To cancel the setting change, press the Cancel/Local key.

To Enable or Disable Over Voltage/Current Protection

For details on this function, see [“Over Voltage/Current Protection” on page 209](#).

1. Press the Config > Source > Connection function keys.

The Output Connection dialog box opens.

2. In the Ch field, set the channel to which the setting change is applied.
3. Set ON (enable) or OFF (disable) in the Over Voltage/Current Protection field.
4. To apply the settings, press Apply.

To apply the settings and close the dialog box, press OK.

To cancel the setting change, press the Cancel/Local key.

To Specify Output-Off Status

For details on this function, see [“Output-Off Status” on page 210](#).

Front Panel Operations To Set Source Output

1. Press the Config > Source > Connection function keys.
The Output Connection dialog box opens.
2. In the Ch field, set the channel to which the setting change is applied.
3. Set HIGH Z (high impedance), NORMAL (normal), or ZERO (zero volt) in the Output-Off State field.
4. To apply the settings, press Apply.
To apply the settings and close the dialog box, press OK.
To cancel the setting change, press the Cancel/Local key.

To Enable or Disable Automatic Output-On Function

For details on this function, see [“Automatic Output-ON/OFF Function” on page 211](#).

1. Press the Config > Source > Connection function keys.
The Output Connection dialog box opens.
2. In the Ch field, set the channel to which the setting change is applied.
3. Set ON (enable) or OFF (disable) in the Auto Output-On field.
4. To apply the settings, press Apply.
To apply the settings and close the dialog box, press OK.
To cancel the setting change, press the Cancel/Local key.

To Enable or Disable Automatic Output-Off Function

For details on this function, see [“Automatic Output-ON/OFF Function” on page 211](#).

1. Press the Config > Source > Connection function keys.
The Output Connection dialog box opens.
2. In the Ch field, set the channel to which the setting change is applied.
3. Set ON (enable) or OFF (disable) in the Auto Output-Off field.
4. To apply the settings, press Apply.
To apply the settings and close the dialog box, press OK.
To cancel the setting change, press the Cancel/Local key.

To Set Ranging Mode of the Sweep Source

For details on this function, see [“Ranging Mode” on page 201](#).

1. Press the Config > Source > Sweep function keys.
The Sweep dialog box opens.
2. In the Ch field, set the channel to which the setting change is applied.
3. Set BEST, AUTO, or FIXED in the Sweep Ranging field. For details, see [“Sweep Dialog Box” on page 135](#).
4. To apply the settings, press Apply.
To apply the settings and close the dialog box, press OK.
To cancel the setting change, press the Cancel/Local key.

To Set Sweep Direction

1. Press the Config > Source > Sweep function keys.
The Sweep dialog box opens.
2. In the Ch field, set the channel to which the setting change is applied.
3. Set UP or DOWN in the Sweep Direction field. For details, see [“Sweep Dialog Box” on page 135](#).
4. To apply the settings, press Apply.
To apply the settings and close the dialog box, press OK.
To cancel the setting change, press the Cancel/Local key.

To Set Source Output Value after Sweep

1. Press the Config > Source > Sweep function keys.
The Sweep dialog box opens.
2. In the Ch field, set the channel to which the setting change is applied.
3. Set START VALUE or END VALUE in the Output after Sweep field. For details, see [“Sweep Dialog Box” on page 135](#).
4. To apply the settings, press Apply.
To apply the settings and close the dialog box, press OK.

Front Panel Operations
To Set Source Output

To cancel the setting change, press the Cancel/Local key.

To Execute Measurement

This section describes the following measurement operations.

- “To Enable Resistance Measurement”
- “To Set Measurement Mode”
- “To Perform Spot Measurement”
- “To Stop Measurement”
- “To Set Measurement Time”
- “To Set Measurement Range”
- “To Perform Sweep Measurement”
- “To Set Measurement Trigger Parameters”
- “To Set Measurement Wait Time”
- “To Set Measurement Auto Range Operation”
- “To Enable or Disable Resistance Compensation”

To Enable Resistance Measurement

1. Press the View key to display the Single view. If the Range parameters are not displayed, press the Hide XXXX assist key.
2. Move the field pointer to the Measure Ohms (resistance measurement range) field. If this field is set to OFF, the resistance measurement is disabled.
3. Press the rotary knob to change the pointer status to EDIT.
4. Press the AUTO, FIXED, or V/I assist key to set the resistance measurement operation. The pointer status is changed to MOVE.

For details on the resistance measurement operation, see “Range parameters” on page 116.

To set the measurement range continuously, see “To Set Measurement Range” on page 187.

To Set Measurement Mode

1. For the Single view, press the Measure assist key. For the Dual view, press the Ch1 Measure or Ch2 Measure assist key.
2. Press AMPS (I) for the current measurement, VOLTS (V) for the voltage measurement, OHMS (R) for the resistance measurement, or WATTS (P) for the power measurement.

To Perform Spot Measurement

1. Set the measurement mode (see [“To Set Measurement Mode” on page 186](#)).
2. Set the output voltage or current (see [“To Apply DC Voltage/Current” on page 175](#)).
3. Press the On/Off switch for channel 1 or 2 (Ch1 or Ch2).
The channel starts the specified voltage/current output. While the switch is turned green, the channel continues the output and changes the value immediately if it is changed.
4. Press the Trigger key.
The spot measurement is performed.

NOTE

To change the Limit value, see [“To Set Limit \(Compliance\) Value” on page 175](#).

To Stop Measurement

1. Press the On/Off switch for channel 1 or 2 (Ch1 or Ch2) to turn the switch off.
The channel stops source output and measurement.

To Set Measurement Time

For details on this function, see [“Measurement Time” on page 202](#) and [“Speed” on page 115](#).

1. Press the View key to display the Single view.
2. Press the Speed assist key.
3. Press the AUTO, SHORT, MEDIUM, NORMAL, LONG, or MANUAL assist key to set the measurement time.

4. When MANUAL is specified, the aperture time setup field and PLC setup field are displayed. Enter and fix a value in either of the fields to set the measurement time.

To Set Measurement Range

For details on this function, see [“Ranging Mode” on page 201](#) and [“Range parameters” on page 116](#).

1. Press the View key to display the Single view. If the Range parameters are not displayed, press the Hide XXXX assist key.
2. Move the field pointer to the Measure Volts (voltage measurement range), Measure Amps (current measurement range), or Measure Ohms (resistance measurement range) field.
3. Press the rotary knob to change the pointer status to EDIT.
4. Press AUTO to set the auto range operation or FIXED to set the fixed range operation. The pointer status is changed to MOVE.
5. Move the field pointer to the range value setup field (on the right side of the Measure Volts, Measure Amps, or Measure Ohms field).
6. Press the rotary knob to change the pointer status to EDIT.
7. Press an assist key to set the following value.

For the auto range operation: Minimum range of the range operation

For the fixed range operation: Range used for measurement

To Perform Sweep Measurement

For details on this function, see [“Sweep Output” on page 206](#).

1. Press the View key to display the Single view.
2. Set the source function (see [“To Set Source Output Mode” on page 175](#)).
3. Set the Source value and Limit (Compliance) value (see [“To Apply DC Voltage/Current”](#) and [“To Set Limit \(Compliance\) Value” on page 175](#)).
4. Set the measurement mode (see [“To Set Measurement Mode” on page 186](#)).
5. Set the sweep source (see [“To Set Sweep Output” on page 177](#)).
6. Press the View key to display the Graph view.
7. Press the On/Off switch for channel 1 or 2 (Ch1 or Ch2).

Front Panel Operations To Execute Measurement

The channel starts the specified voltage/current output. While the switch is turned green, the channel continues the output and changes the value immediately if it is changed.

8. Press the Trigger key.

The sweep measurement is performed and the measurement result is displayed in a graph.

To Set Measurement Trigger Parameters

For details on this function, see [“Trigger System” on page 224](#) and [“Trigger parameters” on page 122](#).

1. Press the View key to display the Single view.
2. Press the Show Trigger assist key to display the Trigger parameters.
3. Move the field pointer to the Trigger field.
4. Press the rotary knob to change the pointer status to EDIT.
5. Press the AUTO, SYNC, TIMER, or MANUAL assist key to set the trigger type. The pointer status is changed to MOVE.
6. Move the field pointer to the trigger parameter setup field (Count, Delay, Period, or Trigger in the Measure column).
7. Press the rotary knob to change the pointer status to EDIT.
8. Enter the trigger count (Count), trigger delay time (Delay), trigger period (Period), or trigger source (Trigger).
9. Press the rotary knob or assist key to fix the setting value.
10. Repeat steps 6 to 9 for all parameters.

NOTE

If you want to set the trigger parameters in detail, select the MANUAL trigger type and use the Trigger Configuration dialog box opened by pressing the Trigger > Config function keys. See [“Trigger Key Group” on page 143](#).

To Set Measurement Wait Time

For details on this function, see [“Measurement Time” on page 202](#) and [“Wait Control Dialog Box” on page 137](#).

1. Press the Config > Common > Wait function keys.

The Wait Control dialog box opens.

2. Set each parameter in the Measure column.
3. To apply the settings, press Apply.

To apply the settings and close the dialog box, press OK.

To cancel the setting change, press the Cancel/Local key.

To Set Measurement Auto Range Operation

For details on this function, see [“Ranging Dialog Box” on page 136](#).

1. Press the Config > Measure > Ranging function keys.

The Ranging dialog box opens.

2. In the Ch field, set the channel to which the setting change is applied.
3. Set the current measurement auto range operation (NORMAL, SPEED, or RESOLN) in the Current Auto Ranging field.

Also, set the threshold of the auto range operation in the Threshold field.

4. Set the voltage measurement auto range operation (NORMAL, SPEED, or RESOLN) in the Voltage Auto Ranging field.

Also, set the threshold of the auto range operation in the Threshold field.

5. To apply the settings, press Apply.

To apply the settings and close the dialog box, press OK.

To cancel the setting change, press the Cancel/Local key.

To Enable or Disable Resistance Compensation

1. Press the Config > Measure > R Compn function keys.
2. For the 2-channel models, specify the channel to which the setting change is applied by using the following function keys.

ALL: Channels 1 and 2 (Ch 1 and Ch 2)

Ch 1: Channel 1 (Ch 1) only

Ch 2: Channel 2 (Ch 2) only

Front Panel Operations
To Execute Measurement

3. To enable the resistance compensation, press ON.
To disable it, press OFF.
To cancel the setting change, press the Cancel/Local key.

To Use Math Function

This section describes how to use the math function. For details on this function, see [“Math Expression” on page 214](#). Also, for details on the setup parameters, see [“Math Expression Dialog Box” on page 138](#).

1. Press the Function > Math function keys.

The Math Expression dialog box opens.

2. In the Ch field, set the channel to which the setting change is applied.
3. In the Status field, set the math function ON (enable) or OFF (disable).
4. In the Unit String field, enter the unit for the calculation result data.

To enter alphabets, press the ABC assist key and then use the numeric/alpha keys.

To enter numbers, press the 123 assist key and then use the numeric/alpha keys.

To delete a character, highlight the character to be deleted and then press the Delete function key.

To insert a character, highlight the character at the position where to insert the character and then press the Insert function key.

5. Select a math expression to use.

To select a math expression, highlight the name of the math expression in the list area below the Unit String field.

6. To apply the settings, press Apply.

To apply the settings and close the dialog box, press OK.

To cancel the setting change, press the Cancel/Local key.

To Execute Limit Test

This section describes how to set the limit test and how to display the result of the limit test. For details on this function, see [“Limit Test” on page 217](#). The limit test is not available for B2901BL.

To perform the limit test, set the composite limit test, individual limit tests, and source output and measurement conditions, and then press the Trigger key.

- [“To Set Composite Limit Test”](#)
- [“To Set Individual Limit Tests”](#)
- [“To Display Limit Test Result”](#)

To Set Composite Limit Test

For details on the setup parameters, see [“Composite Limit Test Setup Dialog Box” on page 139](#).

1. Press the Function > Limit Test > Composite function keys.
The Composite Limit Test dialog box opens.
2. In the Ch field, set the channel to which the setting change is applied.
3. In the Limit Test field, set the composite limit test ON (enable) or OFF (disable).
4. In the Mode field, set the operation mode GRADING (grading mode) or SORTING (sorting mode).
5. In the Auto Clear field, set the automatic clear ON (enable) or OFF (disable) for the composite limit test result.
6. When the operation mode is GRADING, set the test result output timing IMMEDIATE (after every test) or END (after the last test) in the Update field.
7. In the Offset Cancel field, set the offset cancel ON (enable) or OFF (disable).
8. In the Offset field, set the offset value used for the offset cancel.
9. When the operation mode is GRADING, set a bit pattern that represents the limit test pass state (Pass) in the Pass Pattern field.
10. When the operation mode is SORTING, set a bit pattern that represents the limit test fail state (Fail) in the Fail Pattern field.

11. In the /BUSY field, set the DIO pin number used for the BUSY signal output.
12. In the /SOT field, set the DIO pin number used for the start-of-test (SOT) signal output.
13. In the /EOT field, set the DIO pin number used for the end-of-test (EOT) signal output.
14. To apply the settings, press Apply.
To apply the settings and close the dialog box, press OK.
To cancel the setting change, press the Cancel/Local key.

To Set Individual Limit Tests

For details on the setup parameters, see [“Limit Test Setup Dialog Box” on page 140.](#)

1. Press the Function > Limit Test > Limits function keys.
The Limit Test Setup dialog box opens.
2. In the Ch field, set the channel to which the setting change is applied.
3. In the Feed Data field, set the type of data used for the pass/fail judgement of the limit test.
MATH: Calculation result data of math expression
VOLTS: Voltage measurement data (Vmeas)
AMPS: Current measurement data (Imeas)
OHMS: Resistance data (= Vmeas/Imeas)
4. In the Test Index field, set the index of the limit test between numbers 1 and 12.
The index numbers 1 to 12 are associated with the bin numbers 1 to 12. See [“To Display Limit Test Result” on page 195.](#)
5. In the Limit Test field, set the limit test ON (enable) or OFF (disable) for the test identified by Test Index.
6. In the Function field, set the test mode COMPLIANCE (compliance check) or LIMIT (limit test).
7. When the operation mode is SORTING, set a bit pattern that represents the limit test pass state (Pass) in the Pass Pattern field.

Front Panel Operations To Execute Limit Test

8. When the test mode is COMPLIANCE, configure the following settings:
 - In the Fail on field, set the fail judgement method IN or OUT.
IN: Failure if the channel goes into the compliance state.
OUT: Failure if the channel comes out of the compliance state.
 - In the Fail Pattern field, set a bit pattern that represents the limit test fail state (Fail).
9. When the test mode is LIMIT and the operation mode is GRADING, configure the following settings:
 - In the Up Pattern field, set a bit pattern that represents the failed-by-exceeding-upper-limit state.
 - In the Low Pattern field, set a bit pattern that represents the failed-by-exceeding-lower-limit state.
 - In the Up Limit field, set the upper limit for the pass/fail judgement.
 - In the Low Limit field, set the lower limit for the pass/fail judgement.
10. To apply the settings, press Apply.
To apply the settings and close the dialog box, press OK.
To cancel the setting change, press the Cancel/Local key.

NOTE

For using MATH in the pass/fail judgement of the limit test, see [“To Use Math Function” on page 191](#).

For using the resistance compensation, see [“To Enable or Disable Resistance Compensation” on page 189](#).

To Display Limit Test Result

For details on the setup parameters, see [“Limit Test Result Dialog Box” on page 148](#).

1. Press the Result > Limit Test function keys.
The Limit Test Result dialog box opens.
2. In the Ch field, set the channel for the data to be displayed.
The limit test result is displayed in the area below the Length field.
3. Press OK to close the dialog box.

The Length field displays the number of data.

In the area below the Length field, the limit test result is displayed in the following format:

(aaaaa) BIN: bb DATA: +c.ccccccE+ddd

(aaaaa) Data index **aaaaa**

BIN: Bin number **bb** (**01** to **12**)

The bin numbers 1 to 12 are associated with the index numbers 1 to 12. See [“To Set Individual Limit Tests” on page 193](#).

If the limit test data is out of the bins, **00** is set for the GRADING mode and **15** is set for the SORTING mode.

DATA: Limit test data **+c.ccccccE+ddd**

To Use Trace Buffer

This section describes how to set the trace buffer and how to display the statistical data. For details on this function, see [“Trace Buffer” on page 220](#).

To use the trace buffer, set the trace buffer and source output and measurement conditions, and then press the Trigger key.

- [“To Set Trace Buffer”](#)
- [“To Display Statistical Data”](#)

To Set Trace Buffer

For details on the setup parameters, see [“Trace Buffer Setup Dialog Box” on page 141](#).

1. Press the Function > Trace function keys.
The Trace Buffer Setup dialog box opens.
2. In the Ch field, set the channel to which the setting change is applied.
3. In the Feed Data field, set SENSE (for collecting the measurement result data), MATH (for collecting the calculation result data), or LIMIT (for collecting the limit test result data).
4. In the Buffer Control field, set NEXT (for enabling the write operation to the trace buffer) or NEVER (for disabling it).
5. In the Buffer Size field, set the size of the trace buffer (1 to 100000 for models except B2901BL or 1 to 10000 for B2901BL).
6. To apply the settings, press Apply.
To apply the settings and close the dialog box, press OK.
To cancel the setting change, press the Cancel/Local key.

NOTE

To specify the measurement result data (SENSE) to be collected, use [“Format \(Measure\) Dialog Box” on page 154](#).

To specify the calculation result data (MATH) or limit test result data (LIMIT) to be collected, use [“Format \(Math/Limit\) Dialog Box” on page 154](#).

To change the statistical data to be saved in the trace buffer, use [“Format \(Trace\) Dialog Box” on page 154](#).

To Display Statistical Data

For details on the setup parameters, see [“Trace Statistical Result Dialog Box” on page 149](#).

1. Press the Result > Trace function keys.
The Trace Statistical Result dialog box opens.
2. In the Ch field, set the channel for the data to be displayed.
3. In the Element field, set the data type SOURCE (source output data), VOLTS (voltage measurement data), AMPS (current measurement data), OHMS (resistance measurement data) for the statistical calculation.
The statistical data for the data specified here is displayed in the area below the Length field.
4. Press OK to close the dialog box.

The Length field displays the number of data.

The statistical data is displayed in the following fields:

Mean: Mean value

Std. Dev.: Standard deviation

Min.: Minimum value

Max.: Maximum value

To Use Program Memory

This section describes how to select and run a memory program. For details on this function, see [“Program Memory” on page 222](#).

See also [“Program Key Group” on page 151](#).

- [“To Select a Program”](#)
- [“To Control Program Operation”](#)

To Select a Program

1. Press the More > Program > Catalog function keys.
The Program Catalog dialog box opens.
2. Highlight the name of the memory program to run.
3. Press OK.

NOTE

To set a value for a variable used in the memory program, use the Variable dialog box. For details, see [“Program Key Group” on page 151](#).

To Control Program Operation

1. Press the More > Program > Control function keys.
2. Use the following keys to control the operation of a memory program.

Run	Starts the execution of the specified memory program.
Pause	Pauses the execution of the memory program.
Step	Starts the step execution of the specified memory program.
Stop	Stops the execution of the memory program.
Continue	Continues the execution of the memory program presently paused.

6 Function Details

Limit/Compliance	200
Ranging Mode	201
Measurement Time	202
Pulse Output	204
Sweep Output	206
List Sweep	207
Output Filter	208
Over Voltage/Current Protection	209
Output-Off Status	210
Automatic Output-ON/OFF Function	211
High Capacitance Mode	212
Resistance Measurement	213
Math Expression	214
Limit Test	217
Trace Buffer	220
Program Memory	222
Channel Grouping	223
Trigger System	224
File Access Function (Easy File Access)	230
Interlock Function	231
Over Temperature Protection	232
Initial Settings	233

This chapter describes the functions of the Keysight B2900.

Limit/Compliance

Limit/Compliance is the output limiter for preventing damage to the test device from overcurrent or overvoltage. Voltage compliance is for current output channels, and current compliance is for voltage output channels.

When a channel reaches compliance, the channel acts as a constant voltage source or a constant current source. The channel keeps the output value once compliance has been reached.

Compliance can be set with the same resolution and accuracy as output current or output voltage.

To Set Compliance

The following points must be noted when setting the compliance.

- The minimum compliance value is limited as follows.
 - Current compliance
 - 1 % of the range (at 100 nA Range)
 - 1 nA (at 10 nA Range)
 - Voltage compliance
 - 20 mV (at 0.2 V range)
- If the current compliance value is too low, the SMU will require a long settling time.
- Positive and negative compliance values can be set individually. See [“Display Preference Dialog Box” on page 159](#).

Ranging Mode

The following ranging modes are available for performing source output or measurement.

- FIXED (fixed range)

The channel uses the specified range only.

- AUTO (auto range)

The channel automatically uses the range which provides the best resolution for the source output value or the measurement value. It is possible to specify the minimum range effective for the auto range operation.

- BEST (best, only for the sweep source channel)

In the linear sweep mode, the channel automatically uses the minimum range which covers the whole sweep output.

In the log sweep mode, the channel automatically uses the range which provides the best resolution for each sweep step output.

Setting the Ranging Mode

The following points must be noted when setting the ranging mode.

- The measurement channel does not use ranges higher than the minimum range which covers the Limit (Compliance) value.
- The pulsed source channel uses the fixed range for measurement. If the ranging mode other than FIXED is set, the channel automatically uses the minimum range which covers the Limit (Compliance) value.
- For the source side measurement, the channel uses the present output range.
- To set the ranging mode of the DC (constant) source or measurement channel, see [“Range parameters” on page 116](#).
- To set the ranging mode of the sweep source channel, see [“Sweep Dialog Box” on page 135](#).
- To set the detail of the auto ranging operation for measurements, see [“Ranging Dialog Box” on page 136](#).

Measurement Time

Measurement time depends on aperture time, measurement range, and other measurement conditions, and can be expressed by the following formula:

$$\text{Measurement time} = \text{Aperture time} + \text{Overhead time}$$

Aperture time is the time required for measurement, and does not include such factors as range change or data compensation, which would be the overhead time.

Aperture Time

Aperture time is the time required to acquire the measurement data. For accurate and reliable measurement, the aperture time should be increased.

The aperture time is set by using the Measure Speed parameter on the Single view. See [“Speed” on page 115](#).

Overhead Time

Overhead time is the time required for range change, etc. This time depends on the measurement condition, and cannot be specified. Major elements of the overhead time are:

- Range change time during measurement (when measurement ranging mode is set to AUTO)
- Range change time at the start of a measurement (when the measurement range is less than the compliance value)

To Control Source/Measure Timing

The source output and measurement timing can be controlled by the following parameters. See [Figure 6-1](#). This figure shows an example of sweep output. For a bias output, focus the shape of a sweep step only.

1. Source delay

The source delay time is defined as the time from trigger to start of a source output.

2. Measure delay
The measurement delay time is defined as the time from trigger to start of a measurement.
3. Source wait
The source wait time is defined as the time the source channel cannot change the output value after starting an output.
4. Measure wait
The measurement wait time is defined as the time the measurement channel cannot start measurement after starting an output.
5. Period
The period is the trigger interval. It can be defined for the TIMER or MANUAL trigger type (trigger source) and for the source output and measurement actions individually.

Figure 6-1 Source Output and Measurement Timing, Sweep Output Example

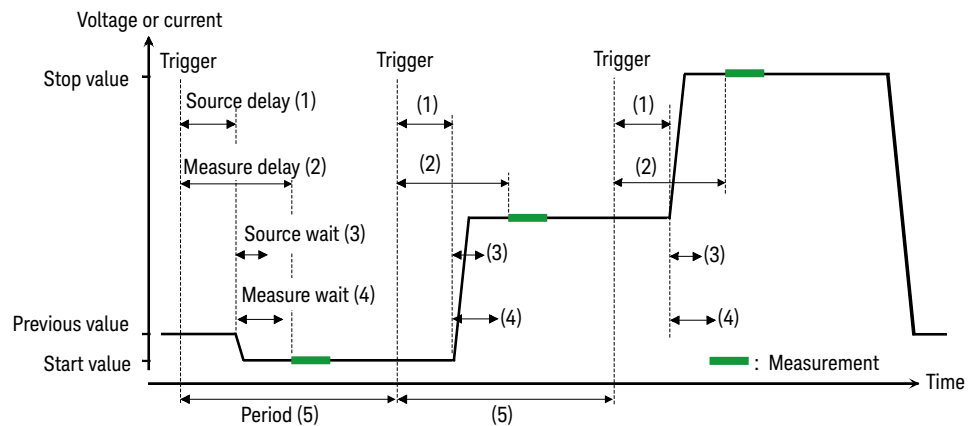

To set the delay time and the period, see [“Trigger parameters” on page 122](#).

To set the wait time, see [“Wait Control Dialog Box” on page 137](#).

For more information about the trigger setup, see [“Trigger Key Group” on page 143](#).

Pulse Output

The source/measure unit SMU can apply the pulsed voltage or current. [Figure 6-2](#) shows a pulsed sweep output example. For a pulsed bias output, focus the shape of a pulse only. The pulse output is not available for B2901BL and B2910BL.

To Control Pulse Output/Measure Timing

The pulse output and measurement timing can be controlled by the following parameters. See [Figure 6-2](#).

1. Source delay

The source delay time is defined as the time from trigger to start of a source output.

2. Measure delay

The measurement delay time is defined as the time from trigger to start of a measurement.

3. Pulse delay

The pulse delay time is defined as the time from the start of a source output to the start of a pulse (peak) output.

4. Source wait

The source wait time is defined as the time the source channel cannot change the output value after the trailing edge of a pulse.

5. Measure wait

The measurement wait time is defined as the time the measurement channel cannot start measurement after the trailing edge of a pulse.

6. Pulse width

The pulse width is the time from the start of a pulse output to the end of a pulse (peak) output. However, it is strictly defined as the time from 10 % of peak level at the leading edge to 90 % of peak level at the trailing edge. The available values are 50 μ s to 100000 s.

Figure 6-2 Pulse Output and Measurement Timing, Sweep Output Example

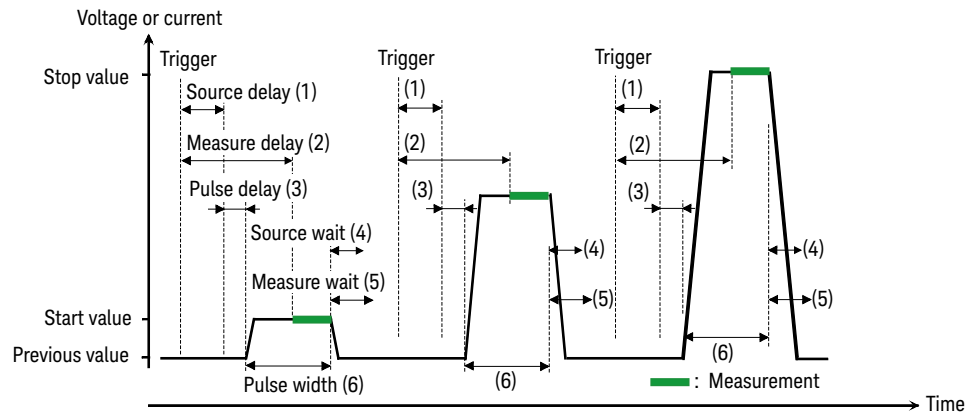

To set the delay time, see [“Trigger parameters” on page 122](#).

To set the pulse delay time and the pulse width, see [“Pulse parameters” on page 121](#).

To set the wait time, see [“Wait Control Dialog Box” on page 137](#).

For more information about the trigger setup, see [“Trigger Key Group” on page 143](#).

To Set Pulse Output

The following points must be noted when setting the pulse output.

- Pulse base value is set by the Source value on the Single or Dual view.
- Pulse peak value is set by the Single view.

Set the Peak value of [“Pulse parameters” on page 121](#) for the pulsed bias output.

Or set the Start, Stop, and Points values of [“Sweep parameters” on page 117](#) for the pulsed sweep output.

Sweep Output

The source/measure unit SMU can apply a sweep voltage or current. It supports several shapes of sweep output, as shown in [Figure 6-3](#). The SMU not only performs the sweep output but performs the measurement for each sweep step as shown in [Figures 6-1](#) and [6-2](#).

Figure 6-3

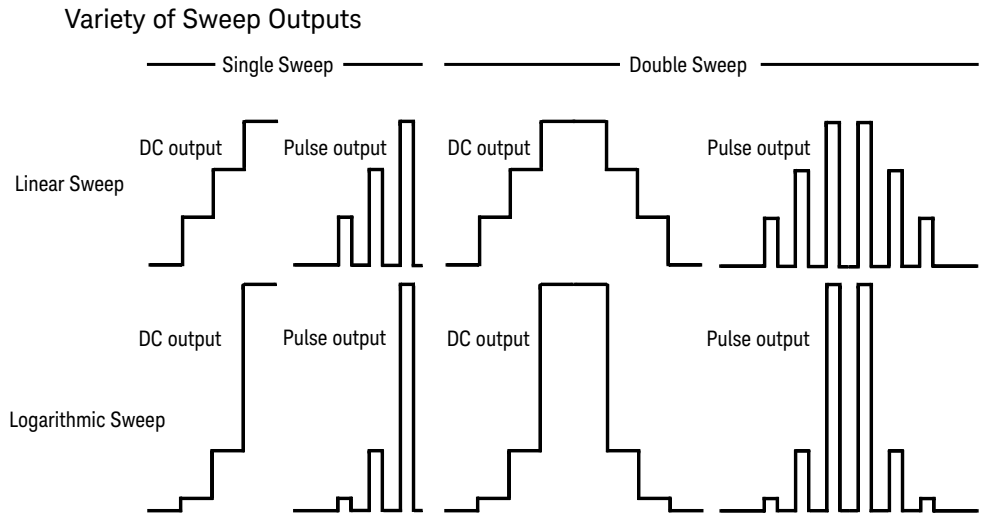

To Set Sweep Output

The following points must be noted when setting the sweep output.

- To set the staircase sweep source, see [“Sweep parameters” on page 117](#).
- To set the ranging mode of the sweep source, see [“Sweep Dialog Box” on page 135](#).
- To set the sweep direction, see [“Sweep Dialog Box” on page 135](#).
- To set the output condition after sweep, see [“Sweep Dialog Box” on page 135](#).
- To set the pulse delay time and the pulse width, see [“Pulse parameters” on page 121](#).
- To set the list sweep source, see [“List sweep setup” on page 118](#).

List Sweep

The list sweep function is effective for performing an arbitrary waveform output. The source/measure unit (SMU) can apply the waveform as shown in [Figure 6-4](#), and measure voltage or current at each output value. The source output and the measurement can be performed in the following minimum interval.

- B2901BL: 200 μ s
- B2910BL: 50 μ s
- B2901B and B2902B: 20 μ s
- B2911B and B2912B: 10 μ s

The source output and measurement timing is controlled by the trigger system. And the interval can be set to a constant value if the trigger type is set to TIMER.

To set these trigger parameters, see [“Trigger parameters” on page 122](#). The interval can be set by the Period parameter. The number of output values can be set by the Count parameter.

To set the source output values, use the List Sweep dialog box. See [“List sweep setup” on page 118](#).

[Figure 6-4](#) shows an example setup of the List Sweep dialog box with an image of the output waveform.

Figure 6-4 List Sweep Dialog Box

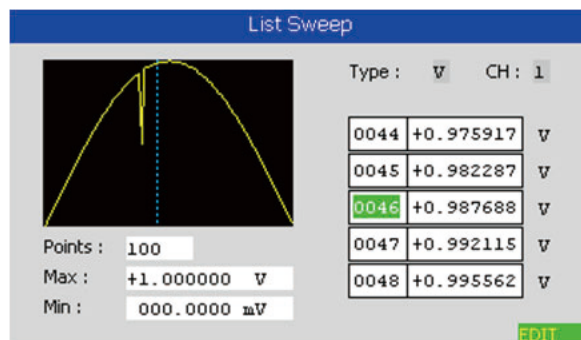

Output Filter

The filter is mounted on the source/measure unit (SMU). It assures clean source output without spikes, noise, and overshooting. However, using a filter may increase the SMU settling time.

To set the filter, see [“Output Filter Dialog Box” on page 133](#).

Over Voltage/Current Protection

The over voltage/current protection is effective for preventing damage to the test device from overcurrent or overvoltage. If this function is enabled, the source/measure unit (SMU) sets the output to 0 V and sets the output switch to off automatically and immediately when it reaches the compliance status.

To set the over voltage/current protection, see [“Output Connection Dialog Box” on page 134](#).

Output-Off Status

The output-off status is the condition which is set on the source/measure unit (SMU) automatically, immediately after its output is turned off. The status must be specified before enabling the source output. The available conditions are shown in [Table 6-1](#).

To set the output-off status, see [“Output Connection Dialog Box” on page 134](#).

Table 6-1

Output-Off State

Name	Conditions after output-off
HIGH Z, high impedance	<ul style="list-style-type: none">• Output relay: off (open or break)• Voltage source setup is not changed if the source applies 40 V or less.• Current source setup is not changed if the source uses the 100 mA range or lower.
NORMAL	<ul style="list-style-type: none">• Source function: Voltage source• Output voltage: 0 V• Current compliance: 100 μA at the 100 μA range• Output relay: off (open or break)
ZERO	<ul style="list-style-type: none">• Source function: Voltage source• Output voltage: 0 V• Current compliance: 100 μA at the 100 μA range

NOTE

This setting is not applied to the output-off process triggered by the emergency condition such as the over voltage/current protection, interlock open, and over temperature protection. Then the output voltage is immediately set to 0 V and the output switch is set to off.

Automatic Output-ON/OFF Function

The automatic output-ON/OFF function defines the source channel's output ON/OFF operation when the trigger system changes the status.

- Automatic-ON function

If this function is enabled, the source/measure unit (SMU) automatically turns the channel output ON just before the trigger system is initiated by an SCPI command, not by a front panel operation.

- Automatic-OFF function

If this function is enabled, the SMU automatically turns the channel output OFF immediately when all trigger system changes the status from busy to idle.

To set the automatic output ON/OFF function, see [“Output Connection Dialog Box” on page 134](#).

High Capacitance Mode

High capacitance mode is effective for the measurement of a capacitive load greater than 0.01 μF .

If the measurement result data is not stable, set this function ON. The measurement data may come stable. This function is effective for measurements of capacitive devices up to 50 μF .

High capacitance mode is available for the following source/measure condition.

- Operation mode: voltage source (Source Volts) and current measurement (Measure Amps)
- Measurement ranging mode: FIXED
- Measurement range: 1 μA to 10 A

To set the high capacitance mode, see [“Output Connection Dialog Box” on page 134](#).

Resistance Measurement

B2900 supports resistance measurement. If the measurement parameter is set to resistance OHMS (R), the source/measure unit (SMU) automatically sets the current source and voltage measurement operation to perform resistance measurement.

For performing accurate measurement, B2900 provides the compensation function.

NOTE

To Enable Resistance Measurement

The resistance measurement operation must be specified. See [“Range parameters” on page 116](#) and [“To Enable Resistance Measurement” on page 185](#).

In the initial setting, the resistance measurement operation is set to OFF.

Resistance Compensation

Resistance compensation (R Compen) is effective for performing low resistance measurements accurately. If R Compen is set to ON, the channel performs measurement twice and returns the compensated measurement result given by the following formula. This technique is effective for reducing the thermal EMF.

$$R_{\text{compen}} = (V_2 - V_1) / (I_2 - I_1)$$

where, V_1 is the measurement results at the 0 A source condition, and I_1 is the measurement results at the 0 V source condition.

To enable resistance compensation, press the Config > Measure > R Compen > ON function key on a 1-channel model, or the Config > Measure > R Compen > ALL or Ch 1 or Ch2 > ON function key on a 2-channel model.

To disable resistance compensation, press the Config > Measure > R Compen > OFF function key on a 1-channel model, or the Config > Measure > R Compen > ALL or Ch 1 or Ch2 > OFF function key on a 2-channel model.

Math Expression

B2900 provides a math function for performing calculations using the measurement result data. The calculation result can be displayed and used for the limit test and trace statistics.

For the predefined math expressions, see [“Predefined Math Expressions” on page 214](#).

To define a math expression, see *Keysight B2900 SCPI Command Reference*. Math expressions can be defined by using the :CALC:MATH commands. For resources effective for the expression, see [“Resources Used in the Expressions” on page 215](#).

To use the math function, see [“Math Expression Dialog Box” on page 138](#).

To display the calculation result, see [“Graph View” on page 124](#) and [“Measure Result Dialog Box” on page 147](#).

Predefined Math Expressions

The following math expressions have already been defined in B2900. The predefined math expressions are not cleared by the power off and on operations.

- Power (POWER)
- Offset Compensated Ohms (OFFCOMPOHM)
- Varistor Alpha (VARALPHA)
- Voltage Coefficient (VOLTCOEF)

In the following formula, [c] specifies the channel (1 or 2) used for the measurement.

POWER Calculates power using the following formula.

$$\text{POWER} = \text{VOLT}[c] * \text{CURR}[c]$$

OFFCOMPOHM Calculates offset compensated ohms (resistance) using the following formula.

$$\text{OFFCOMPOHM} = (\text{VOLT}[c][1] - \text{VOLT}[c][0]) / (\text{CURR}[c][1] - \text{CURR}[c][0])$$

where, VOLT[c][0] and CURR[c][0] are the data measured with a current output level, and VOLT[c][1] and CURR[c][1] are the data measured with a different current output level or zero output.

This function is effective for reducing measurement errors in low resistance measurements.

VARALPHA Calculates varistor alpha using the following formula.

$$\text{VARALPHA} = \log(\text{CURR}[c][1] / \text{CURR}[c][0]) / \log(\text{VOLT}[c][1] / \text{VOLT}[c][0])$$

where, CURR[c][0] and VOLT[c][0] are the measurement data at a point on a varistor's non-linear I-V characteristics curve, and CURR[c][1] and VOLT[c][1] are the data at the another point.

VOLTCOEF Calculates voltage coefficient using the following formula.

$$\text{VOLTCOEF} = (\text{RES}[c][1] - \text{RES}[c][0]) / (\text{RES}[c][1] * (\text{VOLT}[c][1] - \text{VOLT}[c][0])) * 100 \%$$

where, RES[c][0] and RES[c][1] are the resistance measurement data at the first and second measurement points, respectively, and VOLT[c][0] and VOLT[c][1] are the voltage measurement data at the first and second measurement points, respectively.

The voltage coefficient is known as the ratio of the fractional change for a resistor whose resistance varies with voltage.

Resources Used in the Expressions

The following resources can be used in user-defined math expressions.

- Reserved variables

The variables listed in [Table 6-2](#) are reserved for reading the channel output or measurement data.

Scalar variable is used for spot measurement data.

Vector (array) variable is used for sweep measurement data.

- Math operators

The following operators are available.

- Arithmetic operators: +, -, *, /, ^, see [Table 6-3](#).
- Elementary functions: ln, log, sin, cos, tan, exp

The functions log and ln perform the operation after calculating the absolute value. So if a negative value is specified, they do not cause an error but calculate as a positive value. For example, $\log(-10)$ results in $\log(10)=1$.

Table 6-2 Reserved Variables

Reserved variable ^a		Description
Scalar	Vector	
SOUR[c]	SOUR[c] []	Source output setting data
VOLT[c]	VOLT[c] []	Voltage measurement data
CURR[c]	CURR[c] []	Current measurement data
RES[c]	RES[c] []	Resistance measurement data
TIME[c]	TIME[c] []	Time (timestamp) data

a. The numeric suffix [c] is effective for specifying the channel. For example, use CURR2 to read the current spot measurement data of the channel 2.

Table 6-3 Arithmetic and Unary Operators

Priority of task	Operator	Description
High	()	Parentheses
:	+ and -	Unary plus operator and unary minus operator
:	^	Exponentiation operator
:	* and /	Multiplication operator and division operator
Low	+ and -	Additive operator and subtraction operator

Limit Test

Limit test is a pass/fail judgement performed for a measurement data or math result data obtained by a channel. It can be performed if both individual limit test and composite limit test are set to ON. Maximum of twelve limit tests can be defined and used for the bins of composite limit test. The limit test is not available for B2901BL.

Composite limit test supports the following two operation modes.

- Grading mode
Performs limit test for up to 12 test limits (bins) until a failure is detected. See [Figure 6-5](#) for an example flowchart.
- Sorting mode
Performs limit test for up to 12 test limits (bins) until a pass is detected. See [Figure 6-6](#) for an example flowchart.

In the figures, SOT is the start-of-test strobe pulse sent by the component handler connected to B2900 via the Digital I/O connector.

To set the composite limit test, see [“Composite Limit Test Setup Dialog Box” on page 139](#).

To set the individual limit tests, see [“Limit Test Setup Dialog Box” on page 140](#).

The composite limit test result Pass or Fail is displayed with the measurement result data on the Single or Dual view. To display the limit test result log, see [“Limit Test Result Dialog Box” on page 148](#).

NOTE

Limit test for the math result

If the math expression refers to a measurement result data by multiple channels, the acquire trigger count for the channels must be the same.

If the math expression contains a vector operation, the acquire trigger count must be equal to or greater than the maximum number of the vector.

Figure 6-5 Composite Limit Test Flowchart Example for Grading Mode

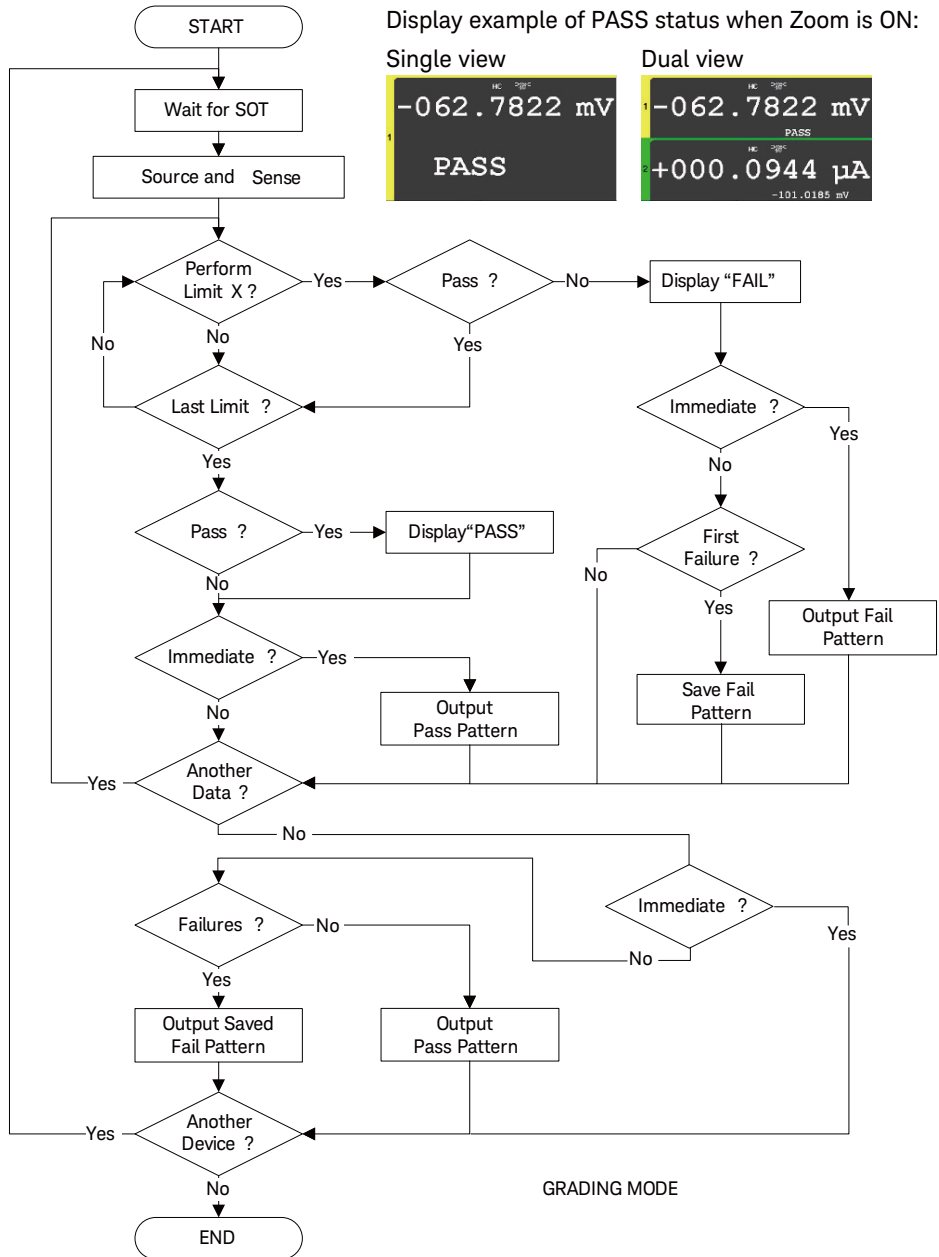
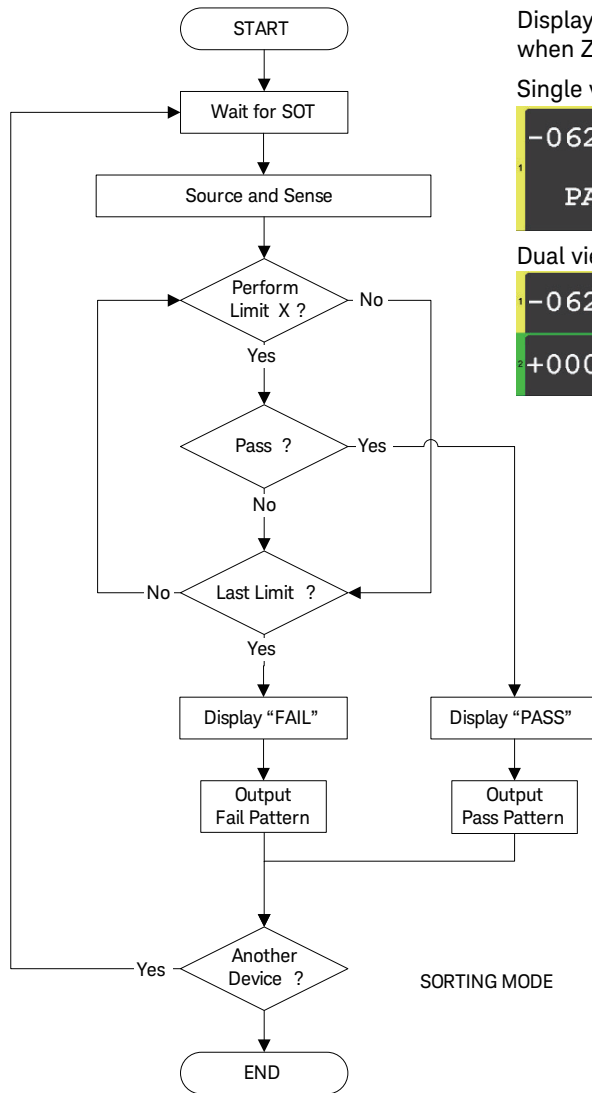
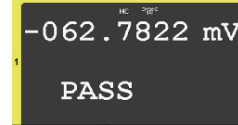

Figure 6-6 Composite Limit Test Flowchart Example for Sorting Mode



Display example of PASS status when Zoom is ON:

Single view



Dual view

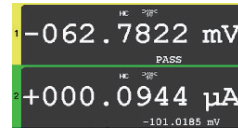

SORTING MODE

Trace Buffer

The trace buffer collects the test result data until a buffer full is detected. The maximum data size is 100,000 blocks for each channel of B2900 except B2901BL. For B2901BL, the maximum data size is 10,000 blocks. The data flow is shown in [Figure 6-7](#). One data block may contain multiple data, such as voltage measurement data, current measurement data, resistance measurement data, source output data, calculation result data, limit test data, time data, and status data. They are selected by using the Format keys of the I/O key group. See [“I/O Key Group” on page 152](#).

For setting the trace buffer, see [“Trace Buffer Setup Dialog Box” on page 141](#).

In [Figure 6-7](#), the variables indicate the following data.

- VOLT: Voltage measurement data
- CURR: Current measurement data
- RES: Resistance measurement data
- TIME: Time data (timestamp of the measurement start trigger)
- STAT: Status data or limit test status
- SOUR: Source output data
- CALC: Math (calculation) result data or limit test data (= raw data - offset data)

If data is stored in the trace buffer, its statistical data can be calculated. Calculable statistical data is as follows.

- MEAN: Mean value
- SDEV: Standard deviation
- MIN: Minimum value
- MAX: Maximum value
- PKPK: Peak to peak value

The statistical data (except for PKPK) of VOLT, CURR, or RES data can be displayed on the Trace Statistical Result dialog box. See [“Trace Statistical Result Dialog Box” on page 149](#) for displaying the data.

Use an external computer to display the data which cannot be displayed on the B2900 screen. The data can be saved in a USB memory connected to the front panel USB-A connector or can be read by using SCPI commands.

NOTE

Do not forget to save or read the data before turning the B2900 off. The trace buffer is cleared by turning the instrument off.

Figure 6-7

Data Flow to Trace Buffer for Each Channel

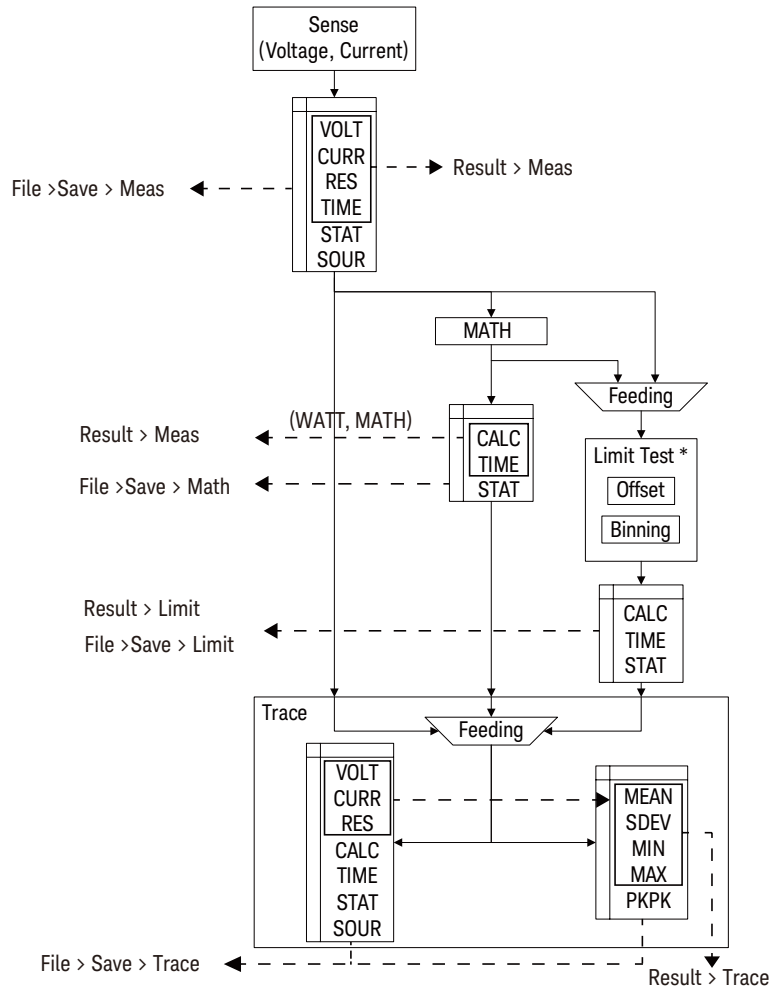

* Limit Test is not available for B2901BL.

Program Memory

The program memory stores command strings temporarily. The stored program can be executed by using the front panel keys, or automatically when B2900 is turned on. See [“Program Key Group” on page 151](#) and [“Start-up” on page 161](#). The keys used for controlling the program memory are shown in [Table 6-4](#). This table also shows the status changed by pressing the program control keys.

The program memory can eliminate several processes in the program execution, such as transferring commands, checking command syntax, and converting commands to the internal codes. Thus, using the program memory speeds up program execution. If frequently used command strings are stored in the program memory, interface/computer activity is minimized.

The program memory can be defined by using SCPI commands while B2900 is in the remote mode. See *Keysight B2900 series SCPI Command Reference*.

- Number of programs saved in the memory: 100
- Number of programs used for start-up automatic execution: 1
- Total memory size: 100 KB
- Maximum length for a line: 256 bytes
- Maximum number of characters of program name: 32 with alphabets, numbers, hyphens, and underscores

Table 6-4 Program Control Keys (Function Keys) and Status Changes

Control key	Present execution status		
	Running	Paused	Stopped
Run	Error	to Running	to Running
Pause	to Paused	Paused	Stopped
Step	Error	to Running to Paused	to Running to Paused
Stop	to Stopped	to Stopped	Stopped
Continue	Error	to Running	Error

Channel Grouping

This section applies only to 2-channel models. This function is used to control the channel output timing automatically so that the channel keeps the output while the other channel performs measurement.

The grouped channels start the source output in the order of channel number, then start the measurement at the same time, and keep the output until the measurement is completed. If delay time and wait time are set, this is adjusted by these values.

If the grouping is released, the channels work independently regardless of the condition of the other channel.

To enable the channel grouping, press the Config > Common > Group > ON function keys.

To disable the channel grouping, press the Config > Common > Group > OFF function keys.

Conditions for the channels to group:

- Trigger source (Trigger value) must be the same.
- If the trigger source is set to TIMER, the trigger period (Period value) of the source output trigger (transient action) must be the same. This is not applicable if the trigger count (Count value) is set to 1.

NOTE

About Wait Time

If wait time is set, channels cannot start measurement or source output change until the wait time elapses. See [“Wait Control Dialog Box” on page 137](#) for setting the wait time.

For the grouped channels, the wait time starts at the timing of the last output change (DC output change or pulse level transition from peak to base) by the last source output channel.

Trigger System

B2900 supports the ARM-TRIGGER model described in *1999 SCPI Command Reference*. Operation summary of this trigger model is described below. Also see [Figure 6-8](#).

The trigger system can be initiated by pressing the Trigger key on the front panel.

For the trigger setup parameters, see [“Trigger parameters” on page 122](#) and [“Trigger Configuration Dialog Box” on page 144](#).

1. Moves to the ARM layer if the trigger system was initiated.
2. Waits for the ARM event which is a signal from the ARM trigger source.
3. Moves to the TRIGGER layer if the ARM event was detected and the ARM delay time elapsed.
4. Waits for the TRIGGER event which is a signal from the TRIGGER trigger source.
5. Executes the device action if the TRIGGER event was detected and the TRIGGER delay time elapsed.
6. Repeats 4 and 5 until the TRIGGER count reaches the specified count. And then moves to the ARM layer.
7. Repeats 2 to 6 until the ARM count reaches the specified count. And then moves to the Idle layer.

This trigger model is applied to two device actions, Transient (source output) and Acquire (measurement) independently. Two actions can start simultaneously or separately.

Also for the 2-channel models, two channels can perform synchronous operation or asynchronous operation.

NOTE

Auto key

The Auto key sets the operation of the trigger system to AUTO or off.

In the AUTO status, the channel in the DC output status (On/Off switch is ON) repeats measurement (Acquire device action) under the predefined trigger conditions. The Transient device action is not performed.

For the predefined trigger conditions, see “Auto” on page -106.

Figure 6-8 B2900 Trigger System

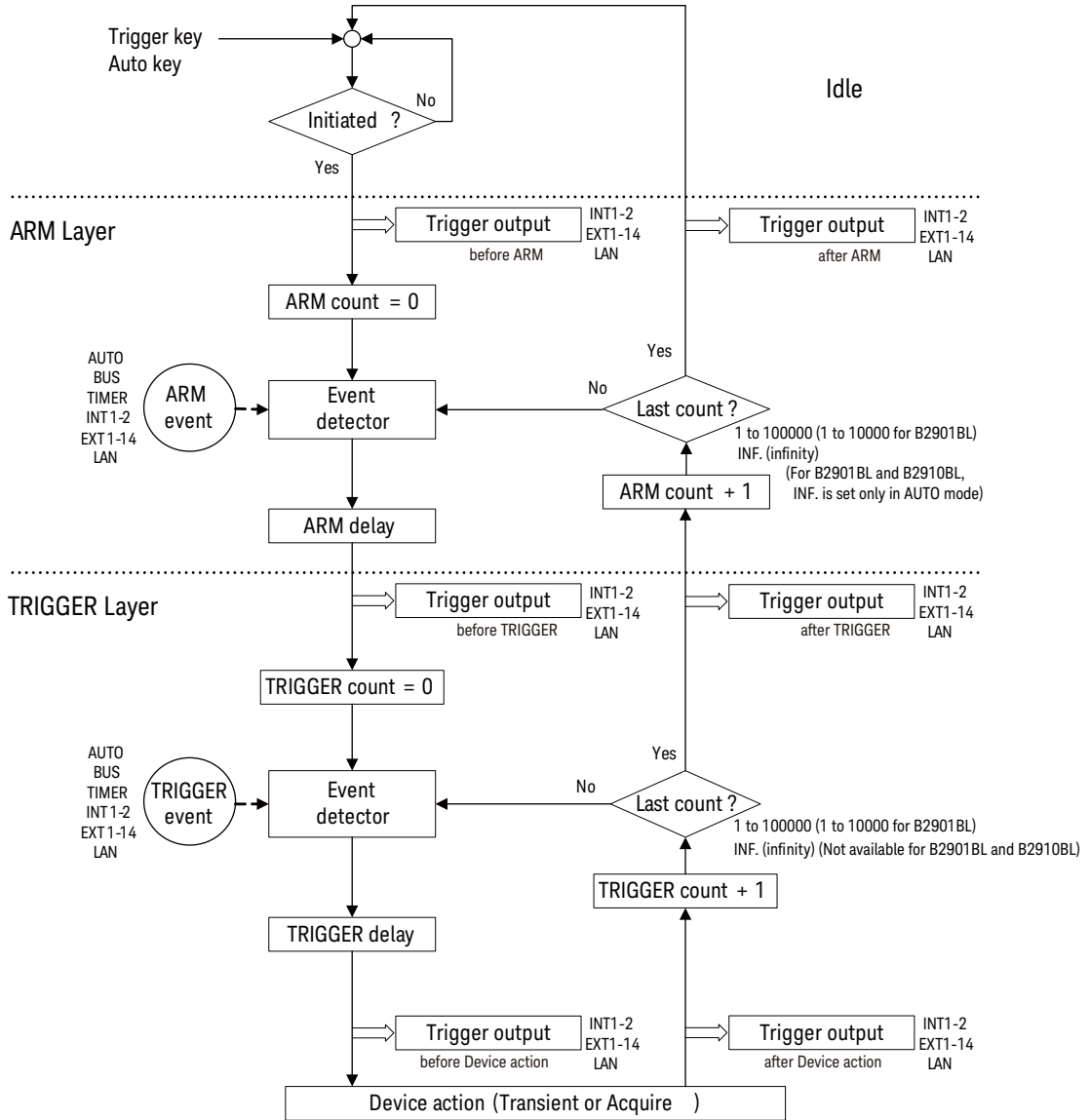

Trigger Source

B2900 supports the following trigger sources. The trigger source must be set to the ARM event and the TRIGGER event individually.

- AUTO (automatic internal, AINT): Trigger source best suited for the present operating mode is automatically selected by the internal algorithms.
- BUS: Remote interface trigger command such as GET, TRIGger, and *TRG
- TIMER (timer, TImer): Signal internally generated every interval set by the Period field
- INT1 or INT2 (internal): Signal from the internal bus 1 or 2
- EXT1, EXT2, EXT3, EXT4, EXT5, EXT6, EXT7, EXT8, EXT9, EXT10, EXT11, EXT12, EXT13, or EXT14 (external): Signal from the DIO pin n , which is an I/O port of the Digital I/O D-sub connector on the rear panel. $n=1$ to 14
- LAN: LXI trigger

Device Actions

B2900 supports the following device actions. Also see [Figure 6-9](#).

- Transient device action (source output)
Source channel starts source output for applying one output value if the TRIGGER event was detected and the Source delay time elapsed.
- Acquire device action (measurement)
Measurement channel starts measurement for obtaining one measurement data if the TRIGGER event was detected and the Measure delay time elapsed.

NOTE

To synchronize the channel operation, for the 2-channel models

If channels are set as shown below, the device actions start simultaneously.

- To synchronize source output:
 - Trigger source is set to the same mode.
 - Delay time is set to the same value.
 - Source output ranging mode is set to the fixed mode.
 - Source wait time control is set to OFF.

Function Details
Trigger System

- Measurement wait time control is set to OFF.
- Measurement ranging mode is set to the fixed mode.
- To synchronize measurement:
 - Trigger source is set to the same mode.
 - Delay time is set to the same value.
 - Measurement wait time control is set to OFF.
 - Measurement ranging mode is set to the fixed mode.

Figure 6-9

Transient and Acquire Device Actions

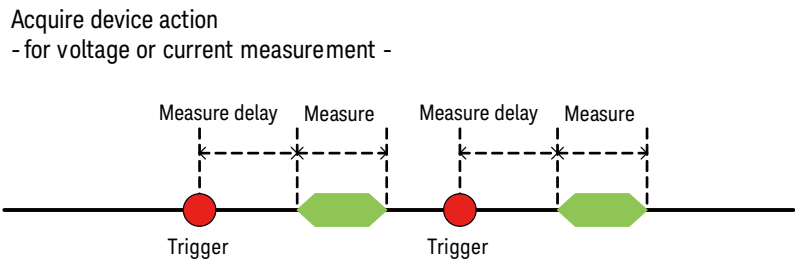
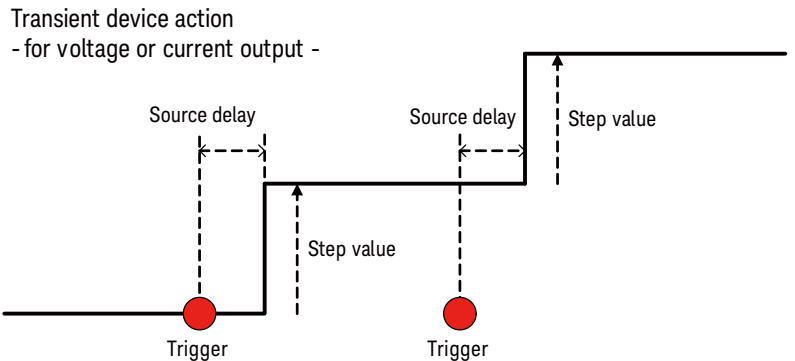

Trigger Output

B2900 can output trigger at the timing of *Trigger output* shown in [Figure 6-8](#). The trigger output terminal can be selected from the following terminals.

- Internal bus, INT1, INT2
- LAN port
- Digital I/O pin, EXT1, EXT2, EXT3, EXT4, EXT5, EXT6, EXT7, EXT8, EXT9, EXT10, EXT11, EXT12, EXT13, EXT14

The trigger output can be set by using “[Trigger Configuration Dialog Box](#)” on [page 144](#). The trigger output timing and the setup parameters are shown in [Table 6-5](#).

Table 6-5 Trigger Output Timing and Setup Parameters

Trigger output timing	Layer	Action	Trigger Output	Output Trigger Timing
Starting ARM loop	ARM	TRANS. for transient action or ACQ. for acquire action	ON	BEFORE
Ending ARM loop	ARM		ON	AFTER
Starting TRIGGER loop	TRIGGER	TRANS. for transient action or ACQ. for acquire action	ON	BEFORE
Ending TRIGGER loop	TRIGGER		ON	AFTER
Starting Transient device action	ACTION	TRANS.	ON	BEFORE
Ending Transient device action	ACTION	TRANS.	ON	AFTER
Starting Acquire device action	ACTION	ACQ.	ON	BEFORE
Ending Acquire device action	ACTION	ACQ.	ON	AFTER

For using a digital I/O pin, it is necessary to set function of the pin, output trigger polarity, type, pulse width, and the Output Trigger Timing parameter. See “[DIO Configuration Dialog Box](#)” on [page 155](#) and “[Using Digital I/O](#)” on [page 101](#).

File Access Function (Easy File Access)

File access function uses MTP (media transfer protocol) to easily download B2900 files (measurement data, instrument settings, and screen images) to your PC. This function is not available for B2901BL and B2910BL.

To use this function, do the steps below.

1. Set ON to the Easy File Access field on the USB Status dialog box opened by More > IO > USB operations.

Changing the setting needs rebooting the B2900.

2. Connect the B2900 to your PC using the furnished USB cable.

The first time you do this, a driver is installed. On subsequent plug-ins an AutoPlay dialog box will pop up on your PC screen, then you will be able to open the device to access the files that are stored on the B2900 internal memory and the USB memory connected to the B2900. The B2900 will appear as a read/writable drive on your PC's file system, and the internal memory and external USB memory will appear as sub-devices of the drive.

For more details, see [Readme.html](#) in the root folder in the internal memory.

NOTE

To control the B2900 using a PC, it must be installed with Keysight IO Libraries Suite or equivalent. However, it is not required if you do not do remote control or if you use the file access function in manual operation.

Interlock Function

The interlock function is designed to prevent electrical shock when a user touches the measurement terminals. If the interlock terminal is open, maximum output is limited to ± 42 V.

To perform high voltage measurement greater than ± 42 V, connect the interlock terminal to an interlock circuit of a test fixture or a shielding box. The interlock circuit must have one LED and two mechanical switches that are connected together and placed near the shielding box opening doors. For details on installing the interlock circuit, see [“Installing the Interlock Circuit” on page 91](#).

The interlock function works as shown below.

- When the interlock terminal is open, maximum output is limited to ± 42 V.
- When the interlock terminal is shorted, source channel can apply its maximum output value.
- When the interlock terminal is opened in a high voltage condition greater than ± 42 V, the output voltage is immediately set to 0 V and the output switch is set to off.

WARNING

Open the interlock terminal so that the SMU cannot apply dangerous voltage when the source/measurement terminal is touchable or opened.



Ouvrir la borne de verrouillage afin que le délivreur de tension ne puisse pas appliquer de tension dangereuse lorsque la borne source/de mesure est à portée de main ou ouverte.

Over Temperature Protection

The over temperature protection is effective for preventing damage to a channel from over temperature. If B2900 is used in an environment over 30 °C, channel outputs are limited to the value less than the maximum value. If a channel output reaches the limit, all channels automatically and immediately set the output to 0 V and set the output switch to off. And the causal channel is locked automatically.

To unlock the channel, the self-test must be performed. If the self-test does not report any problem, you can use the channel soon. For performing the self-test, see [“Self-test” on page 78](#).

The maximum output for the condition over 30 °C is less than the maximum output for the specification condition of 23 °C ± 5 °C. The channel output limit is given by the following formula.

$$DC_{MAX} \leq ([(P_{CS} + 30 - T_{AMB}) - |V_{OAB} \times I_B|] / |V_{OAP} \times I_P|)^2 \times 100$$

The parameters are described below.

- DC_{MAX} : Allowable maximum duty ratio in %, or 0 for DC bias output
- P_{CS} : Maximum power, 64 W
- T_{AMB} : Ambient temperature, in °C
- $V_{OAB} = 250$ V, for $|I_B| \leq 105$ mA
 $V_{OAB} = 39$ V, for $|I_B| > 105$ mA and $|V_B| > 6$ V
 $V_{OAB} = 21$ V, for $|I_B| > 105$ mA and $|V_B| \leq 6$ V
 V_B : Pulse base voltage setting value or DC bias voltage setting value, in V
- I_B : Current at pulse base or DC current, in A
- $V_{OAP} = 250$ V, for $|I_P| \leq 105$ mA
 $V_{OAP} = 39$ V, for $|I_P| > 105$ mA and $|V_P| > 6$ V
 $V_{OAP} = 21$ V, for $|I_P| > 105$ mA and $|V_P| \leq 6$ V
 V_P : Pulse peak voltage setting value, in V
- I_P : Current at pulse peak, in A

Initial Settings

The B2900 is initialized by turning the B2900 on, the *RST command, or the device clear. Initial settings of the B2900 are shown in this section.

Table 6-6 **System Initial Settings**

Setup item	Power on	Reset
GPIO function	DIGITAL IN	
GPIO function (D14)	HIGH VOLTAGE LAMP	
GPIO polarity	NEGATIVE	
GPIO output trigger type	EDGE	
GPIO output trigger timing	BOTH	
GPIO output trigger pulse width	100 μ s	
Display digits	7	
Zoomed display	OFF	Not changed
Display image format	JPG	
User message enable	Disabled	
User message	""	
Byte swap (measurement data)	Normal	
Data format (measurement data)	ASCII	
Data format (GPIO data)	ASCII	
Data format (status register)	ASCII	
Data elements (measurement data)	All (V/I/R/S/T/Stat)	
Data elements (calculate)	CALC	
Automatic timestamp reset	ON	
Mass storage directory	(Root)	

Function Details
Initial Settings

Setup item	Power on	Reset
Program variables	None	Not changed
Program selection	None	
Program status	Idle	

Table 6-7

SMU Initial Settings

Setup item	Power on	Reset
Low terminal state	GROUNDING	Not changed
Output state	OFF	
Output auto filter enable	ON	
Output filter enable	ON	
Output filter time constant	5 μ s	
Output filter frequency	31.8309886 kHz	
Output OFF state	NORMAL	
Output protection	OFF	
Source mode	VOLTS	
Source shape	DC	
Automatic output-on	ON	
Automatic output-off	OFF	
Voltage source	0 V	
Voltage protection level	2 V	
Voltage source auto ranging	ON	
Voltage source range	2 V	
Voltage source range lower limit	0.2 V	
Voltage source mode	Constant voltage	

Setup item	Power on	Reset
Voltage sweep points	1	
Voltage sweep start	0 V	
Voltage sweep stop	0 V	
Voltage list points	1	
Voltage list values	0 V	
Current source	100 μ A	
Current protection level	100 μ A	
Current source auto ranging	ON	
Current source range	100 μ A	
Current source range lower limit	1 μ A	
Current source mode	Constant current	
Current sweep points	1	
Current sweep start	0 A	
Current sweep stop	0 A	
Current list points	1	
Current list values	0 A	
Sweep direction	UP	
Double sweep	OFF	
Sweep ranging	BEST	
Continuous triggered source	ON	
Pulse delay	0 s	
Pulse width	50 μ s	
Auto settling time	ON	
Settling time	0 s	

Function Details
Initial Settings

Setup item	Power on	Reset
Measure function	Current measure	
Auto aperture	ON	
Aperture time	0.1 PLC	
Voltage measure range mode	AUTO	
Voltage measure range limit	0.2 V	
Voltage measure range	2 V	
Current measure range mode	AUTO	
Current measure range limit	1 μ A	
Current measure range	100 μ A	
Resistance measure mode	MAN	
Res. meas. range	2 Ω	
Res. meas. range limit (Low)	2 Ω	
Res. meas. range limit (High)	200 M Ω	
Res. meas. compensation	OFF	
Remote sensing	OFF	
Measurement auto range operation	NORMAL	
Measurement auto range threshold	90	

Table 6-8

Trigger System Initial Settings

Setup item	Power on	Reset
ARM count	1	
ARM source	AINT	

Setup item	Power on	Reset
ARM timer	200 μ s for B2901BL 50 μ s for B2910BL 20 μ s for B2901B/02B 10 μ s for B2911B/12B	
ARM delay time	0 s	
ARM bypass	OFF	
Trigger count	1	
Trigger source	AINT	
Trigger timer	200 μ s for B2901BL 50 μ s for B2910BL 20 μ s for B2901B/02B 10 μ s for B2911B/12B	
Trigger delay time	0 s	
Trigger bypass	OFF	
External trigger output	EXT1	
External trigger output (LAN)	LAN0-7 (all)	
External trigger output enable	OFF	

Table 6-9 LXI Trigger Events Initial Settings

Setup item	Power on	Reset
Event domain	0	
LAN event	"WaitingForAcquireArm1" "WaitingForTransitionArm1" "WaitingForAcquireTrigger1" "WaitingForTransitionTrigger1" "Measuring1" "Settling1" "WaitingForAcquireArm2" "WaitingForTransitionArm2" "WaitingForAcquireTrigger2" "WaitingForTransitionTrigger2" "Measuring2" "Settling2"	
Delay time	0	
Input/output filter string	"ALL:5044"	
Input/output status	OFF	
Input detection	RISE	
Output drive	OFF	
Output slope	Positive	
Output source	"	
Output timestamp delta	0	
Event logging	ON	
Circular event logging	ON	
Event log size	100	

Table 6-10

Calculate Functions Initial Settings

Setup item	Power on	Reset
Composite limit test result transfer timing	IMM	
Composite limit test result automatic clearance	ON	
Composite limit test fail bit pattern	All 0	
Composite limit test pass bit pattern	All 0	
Composite limit test mode	GRADing	
DIO pins for bit pattern output	None	
DIO pin for BUSY signal output	None	
DIO pin for EOT signal output	None	
DIO pin for SOT signal input	None	
Limit test feed source	VOLTage	
Compliance check fail bit pattern	All 0	
Compliance check fail condition	IN	
Limit test function	LIM	
Upper limit	+1.0	
Lower limit	-1.0	
Upper bit pattern	All 0	
Pass bit pattern	All 0	
Lower bit pattern	All 0	
Limit test enable	OFF	
Math function enable	OFF	
Math function expression	(VOLT*CURR)	
Math function expression name	"POWER"	

Function Details
Initial Settings

Setup item	Power on	Reset
Math function catalog	“POWER” “OFFCOMPOHM” “VOLTCOEF” “VARALPHA”	
Math function unit name	“W”	
Offset value for test	0	
Offset value enable	OFF	
Trace feed source	SENSE	
Trace control	NEVer	
Trace points	100000 for models except B2901BL 10000 for B2901BL	
Trace statistics format	MEAN	
Trace timestamp format	ABS	

Table 6-11

Non-volatile Communication Settings

Setup item	Factory default setting
DHCP	Enabled
IP address	169.254.5.2
Subnet mask	255.255.0.0
Default gateway	0.0.0.0
Obtain DNS server from DHCP	Enabled
DNS server	0.0.0.0
WINS server	0.0.0.0
Hostname	K-B29xxB- <i>nnnnn</i> or K-B29xxBL- <i>nnnnn</i>
Desired hostname	B29xxB, B29xxBL: model number
Desired service name	<i>nnnnn</i> : suffix of serial number.

Setup item	Factory default setting
mDNS	Enabled
Use DNS naming service	Enabled
Use NetBIOS naming service	Enabled
Domain name	Not set
GPIB address	23
LXI identify	Disabled
GPIB command interface	Enabled
USB command interface	Enabled
VXI-11 command interface	Enabled
SCPI telnet command interface	Enabled
SCPI socket command interface	Enabled
SCPI HiSLIP command interface	Enabled
Web interface	Enabled
Command prompt for a Telnet session	B2900B>
Welcome message for a Telnet session	Welcome to Keysight B2900B Series

Table 6-12

Other Non-volatile Settings

Setup item	Factory default setting
Channel grouping	“1” for 1-ch models “1-2” for 2-ch models
Remote display	Enabled
Display color set	1
Beeper	Enabled
Graphical web interface (web server)	Enabled

Function Details
Initial Settings

Setup item	Factory default setting
SCPI language mode	Default
Power-on program	Not set
Line frequency	50 Hz
Fan control mode	Normal
V/I Limit for each polarity	OFF
Immediate V/I update by knob	OFF
Restore trigger mode on Local	OFF



Mess- und Prüftechnik. Die Experten.

**Ihr Ansprechpartner /
Your Partner:**

dataTec AG

E-Mail: info@datatec.eu

>>> www.datatec.eu

 **KEYSIGHT**
Authorized Premium
Distributor

This information is subject to change without notice.

© Keysight Technologies 2020, 2023

Edition 2, May 2023



B2910-90110
www.keysight.com