

N2791A 25 MHz and N2891A 70 MHz High-Voltage Differential Probes

User Guide



Distributed by:

Sie haben Fragen oder wünschen eine Beratung? Angebotsanfrage unter **07121 / 51 50 50** oder über info@datatec.de

dataTec

Notices

© Keysight Technologies 2009-2014, 2015, 2017, 2018

No part of this manual may be reproduced in any form or by any means (including electronic storage and retrieval or translation into a foreign language) without prior agreement and written consent from Keysight Technologies as governed by United States and international copyright laws.

Manual Part Number

N2791-97008, December 2018

Available in electronic format only

Published by:

Keysight Technologies, Inc.
1900 Garden of the Gods Road
Colorado Springs, CO 80907 USA

Warranty

THE MATERIAL CONTAINED IN THIS DOCUMENT IS PROVIDED "AS IS," AND IS SUBJECT TO BEING CHANGED, WITHOUT NOTICE, IN FUTURE EDITIONS. FURTHER, TO THE MAXIMUM EXTENT PERMITTED BY APPLICABLE LAW, KEYSIGHT DISCLAIMS ALL WARRANTIES, EITHER EXPRESS OR IMPLIED WITH REGARD TO THIS MANUAL AND ANY INFORMATION CONTAINED HEREIN, INCLUDING BUT NOT LIMITED TO THE IMPLIED WARRANTIES OF MERCHANTABILITY AND FITNESS FOR A PARTICULAR PURPOSE. KEYSIGHT SHALL NOT BE LIABLE FOR ERRORS OR FOR INCIDENTAL OR CONSEQUENTIAL DAMAGES IN CONNECTION WITH THE FURNISHING, USE, OR PERFORMANCE OF THIS DOCUMENT OR ANY INFORMATION CONTAINED HEREIN. SHOULD KEYSIGHT AND THE USER HAVE A SEPARATE WRITTEN AGREEMENT WITH WARRANTY TERMS COVERING THE MATERIAL IN THIS DOCUMENT THAT CONFLICT WITH THESE

TERMS, THE WARRANTY TERMS IN THE SEPARATE AGREEMENT WILL CONTROL.

Technology Licenses

The hardware and/or software described in this document are furnished under a license and may be used or copied only in accordance with the terms of such license.

U.S. Government Rights

The Software is "commercial computer software," as defined by Federal Acquisition Regulation ("FAR") 2.101. Pursuant to FAR 12.212 and 27.405-3 and Department of Defense FAR Supplement ("DFARS") 227.7202, the U.S. government acquires commercial computer software under the same terms by which the software is customarily provided to the public. Accordingly, Keysight provides the Software to U.S. government customers under its standard commercial license, which is embodied in its End User License Agreement (EULA), a copy of which can be found at <http://www.keysight.com/find/sweula>. The license set forth in the EULA represents the exclusive authority by which the U.S. government may use, modify, distribute, or disclose the Software. The EULA and the license set forth therein, does not require or permit, among other things, that Keysight: (1) Furnish technical information related to commercial computer software or commercial computer software documentation that is not customarily provided to the public; or (2) Relinquish to, or otherwise provide, the government rights in excess of these rights customarily provided to the public to use, modify, reproduce, release, perform, display, or disclose commercial computer software or commercial computer software documentation. No additional government requirements beyond those set forth in the EULA shall apply, except to the extent that those terms, rights, or licenses are explicitly

required from all providers of commercial computer software pursuant to the FAR and the DFARS and are set forth specifically in writing elsewhere in the EULA. Keysight shall be under no obligation to update, revise or otherwise modify the Software. With respect to any technical data as defined by FAR 2.101, pursuant to FAR 12.211 and 27.404.2 and DFARS 227.7102, the U.S. government acquires no greater than Limited Rights as defined in FAR 27.401 or DFAR 227.7103-5 (c), as applicable in any technical data. 52.227-14 (June 1987) or DFAR 252.227-7015 (b)(2) (November 1995), as applicable in any technical data.

Safety Notices

CAUTION

A CAUTION notice denotes a hazard. It calls attention to an operating procedure, practice, or the like that, if not correctly performed or adhered to, could result in damage to the product or loss of important data. Do not proceed beyond a CAUTION notice until the indicated conditions are fully understood and met.

WARNING

A WARNING notice denotes a hazard. It calls attention to an operating procedure, practice, or the like that, if not correctly performed or adhered to, could result in personal injury or death. Do not proceed beyond a WARNING notice until the indicated conditions are fully understood and met.

Contents

Inspecting, Cleaning, and Handling the Probe	5
Inspecting the Probe	5
Cleaning the Probe	5
Handling the Probe	5
N2791A/N2891A High-Voltage Differential Probes	6
Battery Use	6
Contents and Accessory Kits	7
Supplied Accessories	7
Optional Accessories	9
Characteristics	10
Safety Information	12
Safety Notices	12
Safety Symbols	13
Safety Warnings and Cautions	13
Using the N2791A High-Voltage Differential Probe	15
Using the N2891A High-Voltage Differential Probe	16
N2791A Plots	17
N2891A Plots	21
Using the Accessories	25
Safety Hook and Alligator Clips	25
Safety Hook and High-Voltage Alligator Clips	25
Extreme Temperature Probing Kit	26
N2791A Performance Verification Procedures	29
DC Differential Gain Accuracy	29
Bandwidth	30
N2791A Performance Verification Test Record	31

Contents

N2891A Performance Verification Procedures	32
DC Differential Gain Accuracy	32
Bandwidth	34
N2891A Performance Verification Test Record	35
Offset Zero Calibration Procedure	36

Keysight N2791A/N2891A High-Voltage Differential Probes User Guide

Inspecting, Cleaning, and Handling the Probe

Inspecting the Probe

- Inspect the shipping container for damage.
Keep the damaged shipping container or cushioning material until the contents of the shipment have been checked for completeness and the probe has been checked mechanically and electrically.
- Check the accessories.
If the contents are incomplete or damaged, notify your Keysight Technologies Sales Office.
- Inspect the probe.
If there is mechanical damage or defect, or if the probe does not operate properly or pass calibration tests, notify your Keysight Technologies Sales Office.

If the shipping container is damaged, or the cushioning materials show signs of stress, notify the carrier as well as your Keysight Technologies Sales Office. Keep the shipping materials for the carrier's inspection. The Keysight Technologies office will arrange for repair or replacement at Keysight Technologies' option without waiting for claim settlement.

Cleaning the Probe

Disconnect the probe and clean it with a soft, damp cloth. Make sure the probe is completely dry before reconnecting it to an oscilloscope.

Handling the Probe



Handle the probe with care and refer to the **"Safety Notices"** on page 12. Note that the probe cable and the extreme temperature extension cables are sensitive parts and, therefore, you should be careful not to damage them through excessive bending or pulling. You should also avoid any mechanical shocks to this product in order to guarantee accurate performance and protection.

N2791A/N2891A High-Voltage Differential Probes

The N2791A/N2891A high-voltage differential probes allow conventional earth-grounded oscilloscopes to be used for floating signal measurements (up to 700 V of differential or common mode voltage for the N2791A and up to 7000 V of differential or common mode voltage for the N2891A). The N2791A offers user-selectable attenuation settings of 10:1 and 100:1 while the N2891A offers attenuation settings of 100:1 and 1000:1, making both probes highly versatile and usable for a broad range of applications including power supply measurements and motor controls. Both probes are compatible with any oscilloscope with a 1 M Ω BNC input. The probes can be powered by any USB port on an oscilloscope or computer, or by internal batteries (4x AA included with the probe).

The images below show some key parts of the N2891A probe body. The N2791A has similar switches/LEDs, but they are arranged differently.

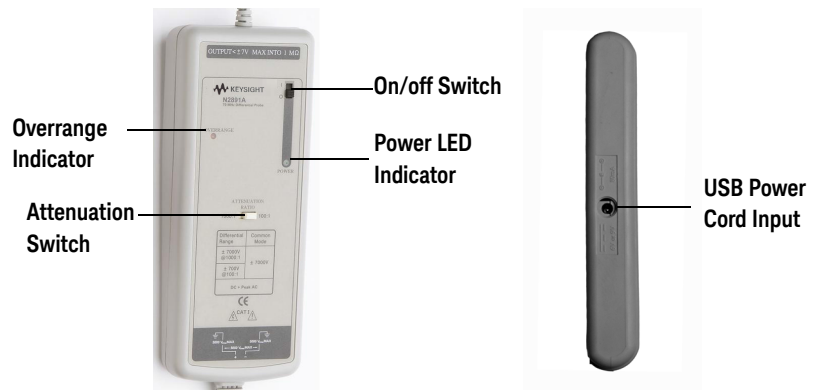

Battery Use

- Insert 4 AA batteries in the back of the unit as indicated within the chassis (see [page 15](#) for information on accessing the battery location).
- When battery life has expired, remove the batteries.
- When the batteries get close to running out, the power indicator will start to flicker and dim.
- Note the WEEE label on the batteries and dispose of properly

Contents and Accessory Kits

Supplied Accessories

The following table lists the parts included with the N2791A high-voltage differential probe.

Part	Quantity
N2791A 25 MHz Differential Probe	1
Safety Hook, Red	1
Safety Hook, Black	1
Alligator Clip, Red	1
Alligator Clip, Black	1
USB Power Cord (2 m)	1
AA Battery	4
Trimmer Tool	1
Probe Resource Center Note	1

For N2791A replacement accessories, you can order the N2791-68700 Differential Probe Accessory Kit. It includes:

Part	Quantity
Safety Hook, Red	1
Safety Hook, Black	1
Alligator Clip, Red	1
Alligator Clip, Black	1
USB Power Cord (2 m)	1

The following table lists the parts included with the N2891A high-voltage differential probe.

Part	Quantity
N2891A 70 MHz Differential Probe	1
Safety Hook, Red	1
Safety Hook, Black	1
High Voltage Alligator Clip, Red	1
High Voltage Alligator Clip, Black	1
USB Power Cord (2 m)	1
AA Battery	4
Trimmer Tool	1
Probe Resource Center Note	1

For N2891A replacement accessories, you can order the N2891-68700 Differential Probe Accessory Kit. It includes:

Part	Quantity
Safety Hook, Red	1
Safety Hook, Black	1
High Voltage Alligator Clip, Red	1
High Voltage Alligator Clip, Black	1
USB Power Cord (2 m)	1

Optional Accessories

For extreme temperature probing, you can order the N7013/14A extreme temperature probing kit separately. This extreme temperature probing kit is not compatible with the N2891A probes. The quantity for each accessory in the kit is the same as listed in [Table 1](#).

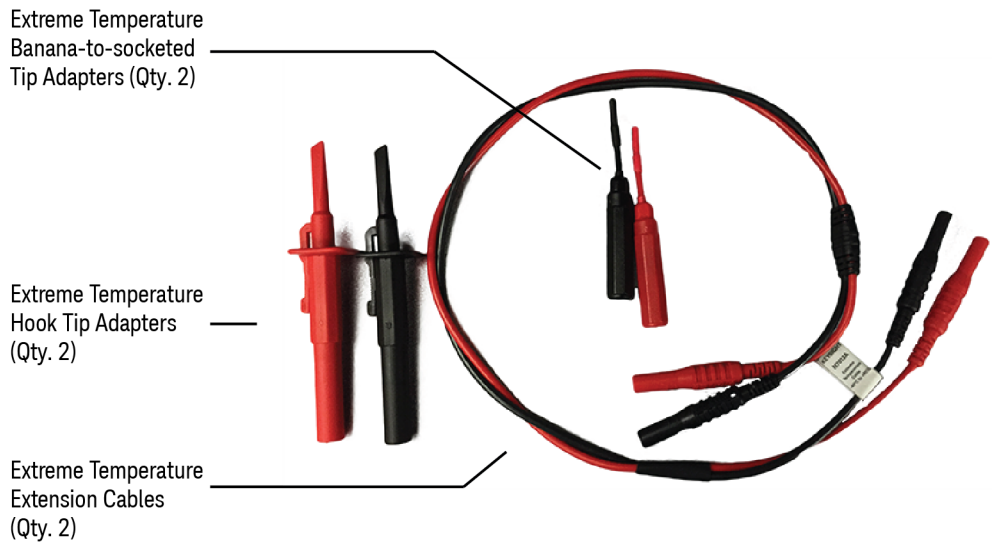

Figure 1 N2791A Optional Accessories (Extreme Temperature Probing Kit)

Table 1 N2791A Optional Accessories

Accessory	Qty
Extreme Temperature Hook Tip Adapters (Black)	1
Extreme Temperature Hook Tip Adapters (Red)	1
Extreme Temperature Differential Extension Cables (Black)	1
Extreme Temperature Differential Extension Cables (Red)	1
Extreme Temperature Banana-to-Socketed Tip Adapters for connecting to 0.025" square pins (Black)	1
Extreme Temperature Banana-to-Socketed Tip Adapters for connecting to 0.025" square pins (Red)	1

Characteristics

Characteristics for the N2791A and N2891A high-voltage differential probes are shown below. The probe / oscilloscope should be warmed up for at least 20 minutes before any testing and the environmental conditions should not exceed the probe's specified limits.

Table 2 Electrical Characteristics

Description	N2791A without the N7013/14A Extreme Temperature Probing Kit*	N2791A with the N7013/14A Extreme Temperature Probing Kit*	N2891A*
Bandwidth (-3 dB)	>25 MHz (driving 1 M Ω oscilloscope input)	25 MHz (driving 1 M Ω oscilloscope input)	70 MHz (driving 1 M Ω oscilloscope input)
Attenuation ratio	10:1, 100:1 (switchable)	10:1, 100:1 (switchable)	100:1, 1000:1 (switchable)
Probe Risetime (10%-90%)	14 ns	14 ns	5 ns
Absolute Maximum Rated Input Voltage (each side to ground)	1000 Vrms CAT III	1000 Vrms CAT III	5000 Vrms mains isolated
Maximum Differential Input Voltage (DC + AC Peak)	± 70 V at 10:1 attenuation ± 700 V at 100:1 attenuation	± 70 V at 10:1 attenuation ± 700 V at 100:1 attenuation	± 700 V at 100:1 attenuation ± 7000 V at 1000:1 attenuation
Maximum Common Mode Input Voltage	± 70 V at 10:1 attenuation ± 700 V at 100:1 attenuation	± 70 V at 10:1 attenuation ± 700 V at 100:1 attenuation	± 7000 V at 10:1 attenuation ± 7000 V at 1000:1 attenuation
Input Impedance	4 M Ω , 10 pF (each side to ground) 8 M Ω , 5 pF (between inputs)	4 M Ω , 10 pF (each side to ground) 8 M Ω , 5 pF (between inputs)	50 M Ω , 10 pF (each side to ground) 100 M Ω , 5 pF (between inputs)
Output Voltage Swing	± 7 V (driving 1 M Ω oscilloscope input)	± 7 V (driving 1 M Ω oscilloscope input)	± 7 V (driving 1 M Ω oscilloscope input)
Offset (typical)	± 7.5 mV (adjustable)	± 7.5 mV (adjustable)	± 5 mV (adjustable)
CMRR (typical)	-80 dB at 60 Hz, -40 dB at 1 MHz	-80 dB at 60 Hz, -40 dB at 1 MHz	-80 dB at 50 Hz, -60 dB at 20 kHz
Power Requirements	4 AA batteries or USB power adapter (5 V/200 mA, 9 V/120 mA)	4 AA batteries or USB power adapter (5 V/200 mA, 9 V/120 mA)	4 AA batteries or USB power adapter (5 V/200 mA, 9 V/120 mA)
Battery Life	15 hours (alkaline battery)	15 hours (alkaline battery)	11.5 hours (alkaline battery)
Battery/Power Cord	The supplied voltage must be less than 12 V and greater than 4.4 V or else the probe could be damaged		

* All are typical

Table 3 Mechanical Characteristics

Description	N2791A	N2891A
Weight (probe only)	400 g (probe and PVC jacket)	500 g
BNC Cable Length	95 cm (37 inches)	90 cm (35 inches)
Length of Input Leads	45 cm (18 inches)	60 cm (24inches)
Length of Extreme Temperature Extension Cables	70 cm (27.5 inches)	N/A
Dimensions (L x W x H)	170 mm x 63 mm x 21 mm (6.7 inches x 2.5 inches x 0.83 inches)	202 mm x 83 mm x 38 mm (8.0 inches x 3.3 inches x 1.5 inches)

Table 4 Environmental Specifications (same for both N2791A and N2891A)

Description	Specifications
Temperature	Operating: +5 °C to +40 °C (Probe without the N7013/14A extreme temperature probing kit) Operating: -40 °C to +85 °C (Probe with the N7013/14A extreme temperature probing kit) Nonoperating: -30 °C to +70 °C
Altitude	Operating: 2,000 m Nonoperating: 15,300 m
Humidity	Operating: 80% RH @ 31 °C decreasing linearly to 50% RH at 40 °C Nonoperating: 25 - 85% room humidity
Pollution Degree	Pollution Degree 2

Table 5 Safety Specifications

Safety Specifications
IEC61010-031

Safety Information

Safety Notices

This apparatus has been designed and tested in accordance with IEC 61010-031, Safety Requirements for Measuring Apparatus, and has been supplied in a safe condition. This is a Safety Class I instrument (provided with terminal for protective earthing). Before applying power, verify that the correct safety precautions are taken (see the following warnings). In addition, note the external markings on the instrument that are described under "Safety Symbols" on page 13.

WARNING

Whenever it is likely that the ground protection is impaired, you must make the instrument inoperative and secure it against any unintended operation.

WARNING

Do not attempt internal service or adjustment.

Service should be carried out by a Keysight Technologies authorized service personnel. For any service needs, contact Keysight Technologies.

WARNING

Do not install substitute parts or perform any unauthorized modification to the instrument.

WARNING

Capacitors inside the instrument may retain a charge even if the instrument is disconnected from its source of supply.

WARNING

Do not use the instrument in a manner not specified by the manufacturer. If used in a manner not specified by the manufacturer, the protection provided by the probe assembly may be impaired.

Safety Symbols



Instruction manual symbol: The product is marked with this symbol when it is necessary for you to refer to the instruction manual in order to protect against damage to the product or personal injury.



Hazardous voltage symbol

Safety Warnings and Cautions

WARNING

Observe Maximum Working Voltage. To avoid injury, do not use the N2791A probe above 1000 Vrms CAT III (both 10:1 and 100:1 attenuation settings) between each input lead and earth or between the two input leads. Do not use the N2891A probe above 5000 Vrms mains isolated (1000:1 attenuation) or 500 Vrms mains isolated (100:1 attenuation) between the two input leads. Do not use the N2891A probe above 5000 Vrms mains isolated (both 100:1 and 1000:1 attenuation settings) between each input lead and earth.

WARNING

Must be Grounded. Before making connections to the input leads of this probe, ensure that the output BNC connector is attached to the BNC channel input of the oscilloscope and the oscilloscope is properly grounded.

WARNING

Do Not Operate Without Covers. To avoid electrical shock or fire hazard, do not operate this probe with the covers removed.

WARNING

To avoid electric shock, injury, or fire hazard, do not operate this probe in wet / damp conditions or in an explosive atmosphere.

WARNING

Avoid Exposed Circuit. To avoid injury, remove jewelry such as rings, watches, and other metallic objects. Do not touch exposed connections and components when power is present.

WARNING

Use Proper Power Source. To ensure this probe functions well, use four AA batteries or the supplied USB power cord.

WARNING

For Indoor Use Only.

WARNING

Periodically inspect the probe and probe wires to check for any damage. Do Not Operate With Visible or Suspected Failures. If you suspect there is damage, have it inspected by a Keysight authorized service personnel.

CAUTION

The probe cable and the extreme temperature extension cables are sensitive parts and, therefore, you should be careful not to damage them through excessive bending or pulling. Avoid any mechanical shocks to this product in order to guarantee accurate performance and protection.

Using the N2791A High-Voltage Differential Probe

- 1 To use this probe, first insert the four AA batteries into the probe or connect the USB power cord to the probe and a USB port (see [page 6](#) to see where the USB power cord input is located on the probe).



**To replace batteries,
first slip off the cover**



**Then slide the battery cover
off on the rear of the probe**

- 2 Then connect the BNC output connector to the channel input of the oscilloscope. The oscilloscope must have a ground referenced.
- 3 Select the proper attenuation ratio (10:1 or 100:1) on the probe via the attenuation switch and specify the attenuation and probe configuration on your oscilloscope.

NOTE

TIP: When measuring signals below 70 V, switch the attenuation ratio to 10:1 in order to obtain a higher resolution signal with less noise. Otherwise set the attenuation ratio to 100:1.

- 4 Using the appropriate probe accessories, connect the inputs to the circuit under test.

CAUTION

To protect against electrical shock, use only the accessories supplied with this probe or in the accessory kit.

CAUTION

This probe is to carry out differential measurements between two points on the circuit under test. This probe is not for electrically insulating the circuit under test and the measuring instrument.

Using the N2891A High-Voltage Differential Probe

- 1 To use this probe, first insert the four AA batteries into the probe or connect the USB power cord to the probe and a USB port (see [page 6](#) to see where the USB power cord input is located on the probe).



Slide the battery cover off the rear of the probe body

- 2 Then connect the BNC output connector to the channel input of the oscilloscope. The oscilloscope must have a ground referenced.
- 3 Select the proper attenuation ratio (100:1 or 1000:1) on the probe via the attenuation switch (see the picture on [page 6](#)) and specify the attenuation and probe configuration on your oscilloscope.

NOTE

TIP: When measuring signals below 700 V, switch the attenuation ratio to 100:1 in order to obtain a higher resolution signal with less noise. Otherwise set the attenuation ratio to 1000:1.

- 4 Using the appropriate probe accessories, connect the inputs to the circuit under test.

CAUTION

To protect against electrical shock, use only the accessories supplied with this probe or in the accessory kit.

CAUTION

This probe is to carry out differential measurements between two points on the circuit under test. This probe is not for electrically insulating the circuit under test and the measuring instrument.

N2791A Plots

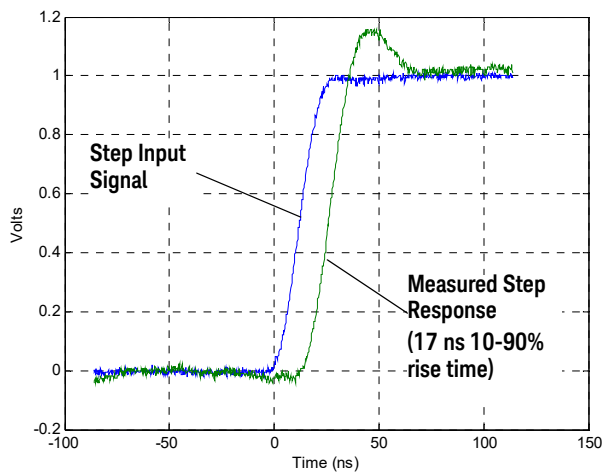

Figure 2 Graph of normalized step response (50Ω , 16.5 ns rising edge step generator), 17 ns normalized rising edge (10-90%), 10:1 attenuation

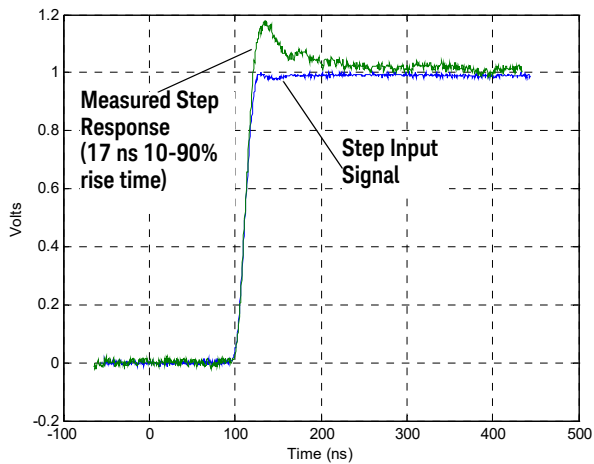

Figure 3 Graph of normalized step response (50Ω , 17 ns rising edge step generator), 17 ns normalized rising edge (10-90%), 100:1 attenuation

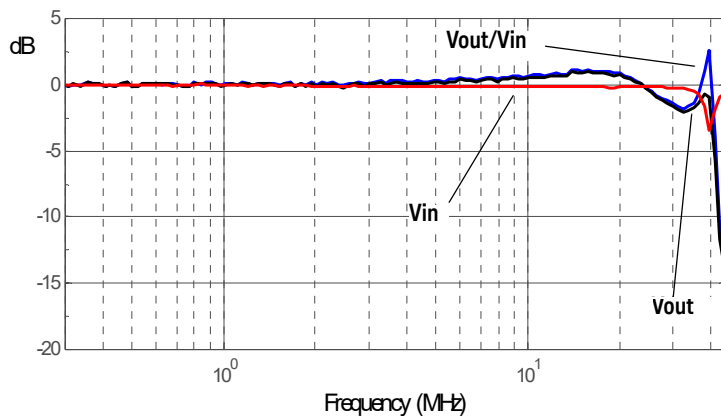

Figure 4 Graph of $\text{dB}(V_{in})$, $\text{dB}(V_{out}) + 20\text{dB}$, and $\text{dB}(V_{out}/V_{in}) + 20\text{dB}$ frequency response, 10:1 attenuation

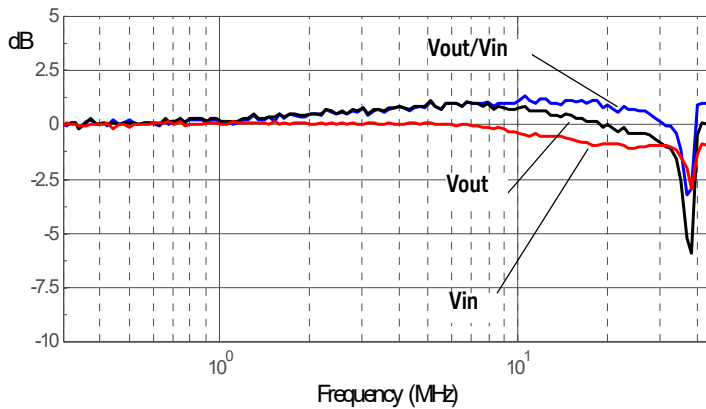

Figure 5 Graph of $\text{dB}(V_{in})$, $\text{dB}(V_{out}) + 40\text{dB}$, and $\text{dB}(V_{out}/V_{in}) + 40\text{dB}$ frequency response, 100:1 attenuation

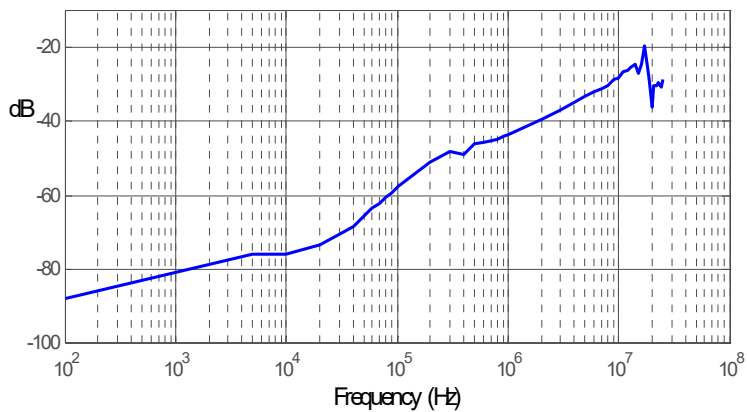

Figure 6 Graph of dB (Vout/Vin) + 20dB frequency response when inputs driven in common mode (common mode rejection), 10:1 attenuation

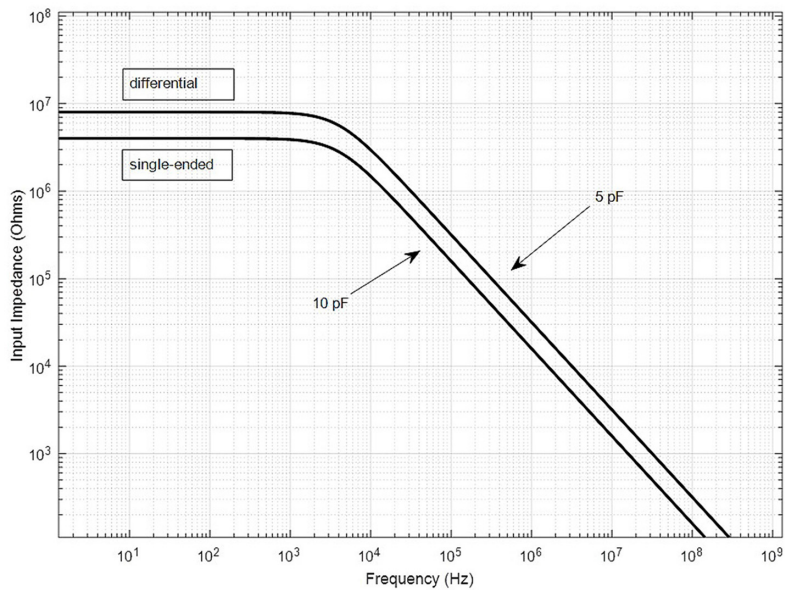

Figure 7 Magnitude plot of probe input impedance versus frequency (differential & single-ended)

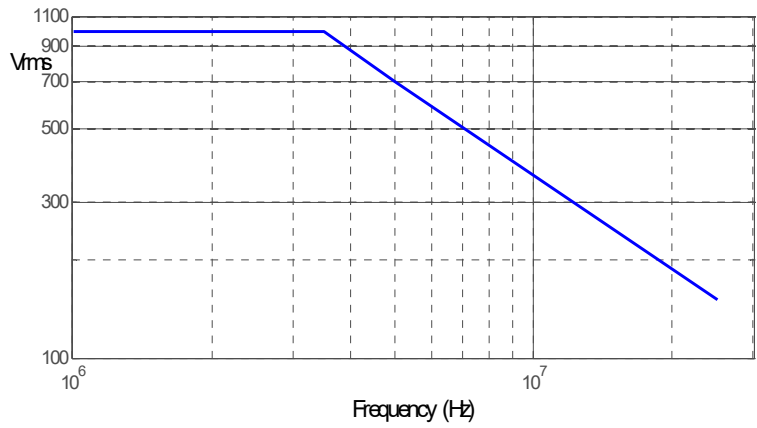

Figure 8 Typical derating plot of the absolute maximum input voltage in common mode

N2891A Plots

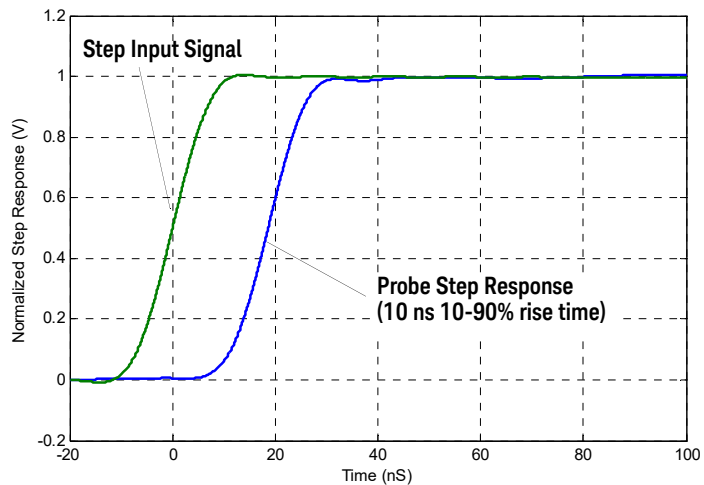

Figure 9 Graph of normalized step response (50 Ω, 10 ns rising edge step generator), 10 ns normalized rising edge (10-90%), 100:1 attenuation

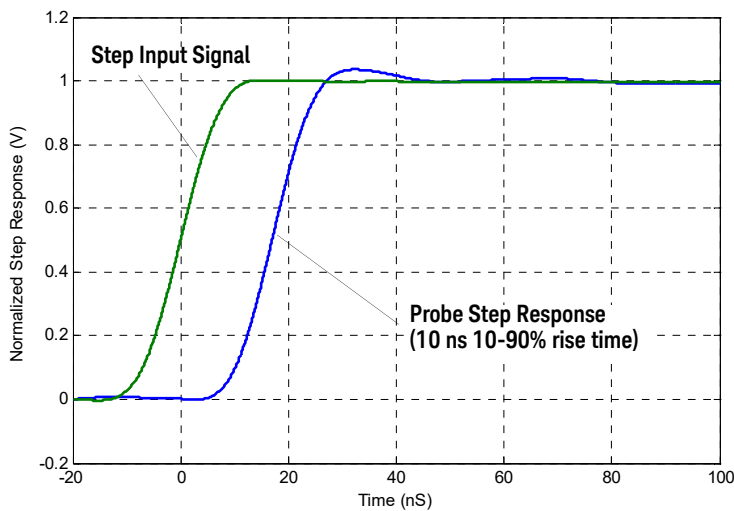

Figure 10 Graph of normalized step response (50 Ω, 10 ns rising edge step generator), 10 ns normalized rising edge (10-90%), 1000:1 attenuation

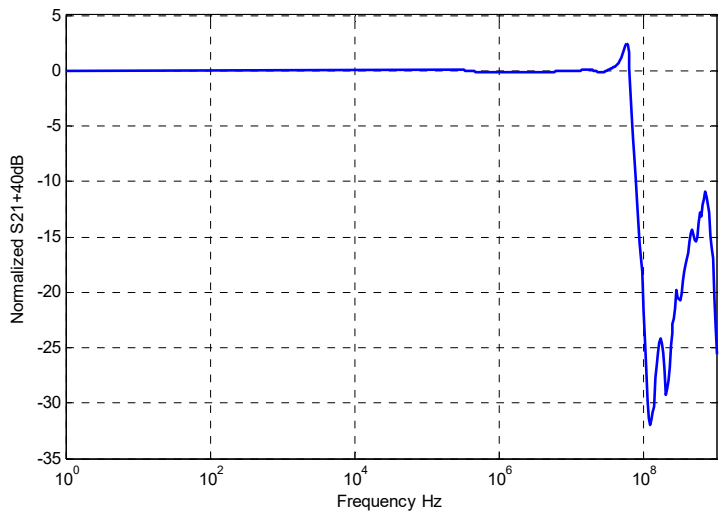

Figure 11 Graph of dB (S21) + 40 dB frequency response, 100:1 attenuation

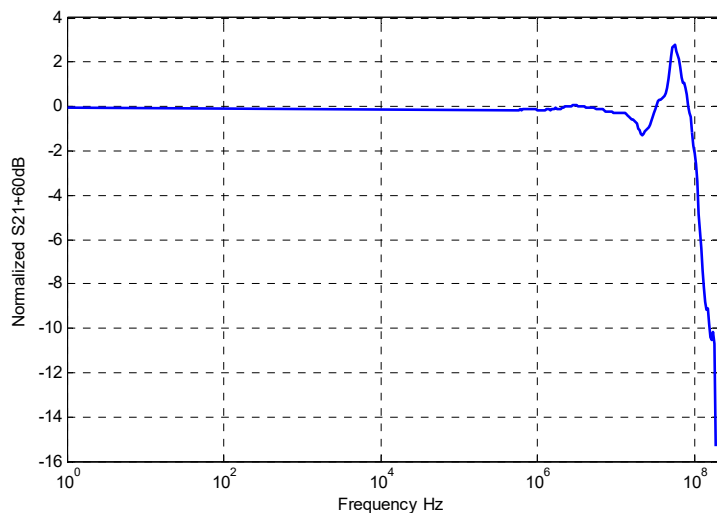

Figure 12 Graph of dB (S21) + 60 dB frequency response, 1000:1 attenuation

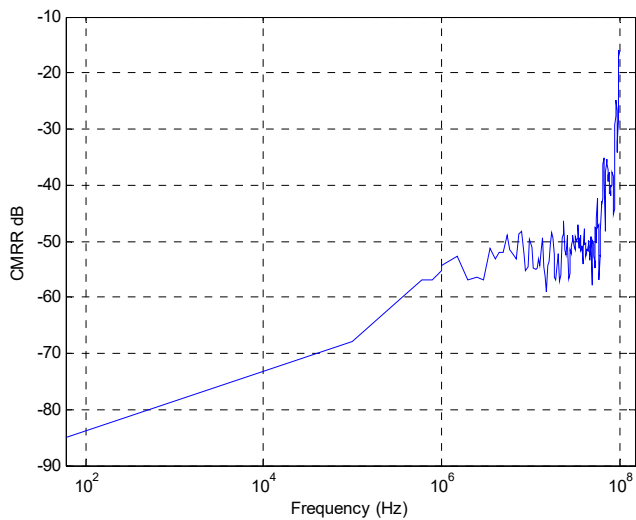

Figure 13 Graph of dB (S21) + 40 dB frequency response when inputs driven in common mode (common mode rejection), 100:1 attenuation

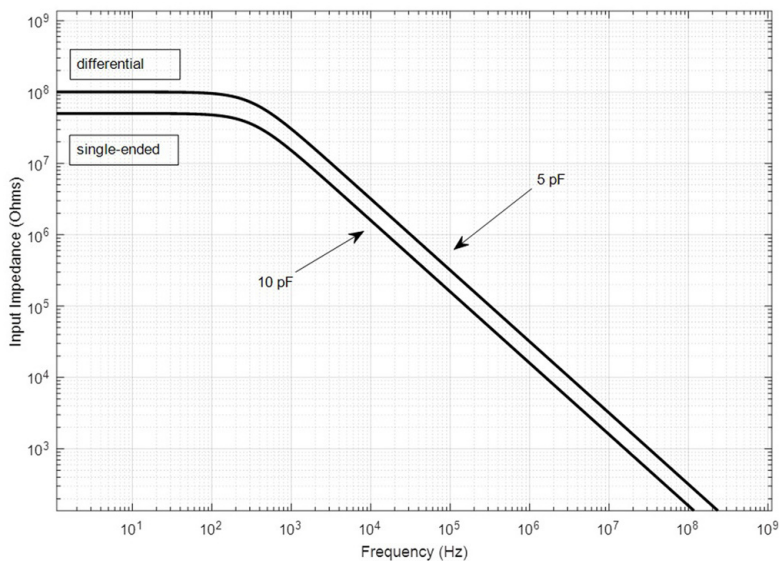

Figure 14 Magnitude plot of probe input impedance versus frequency, single-ended

and differential

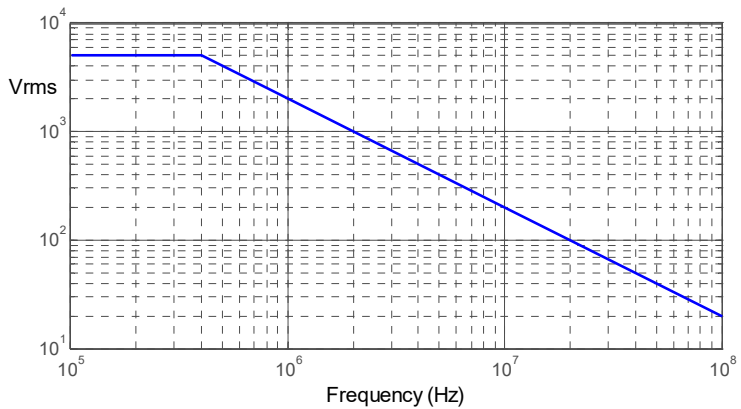

Figure 15 Typical derating plot of absolute maximum input voltage in common mode

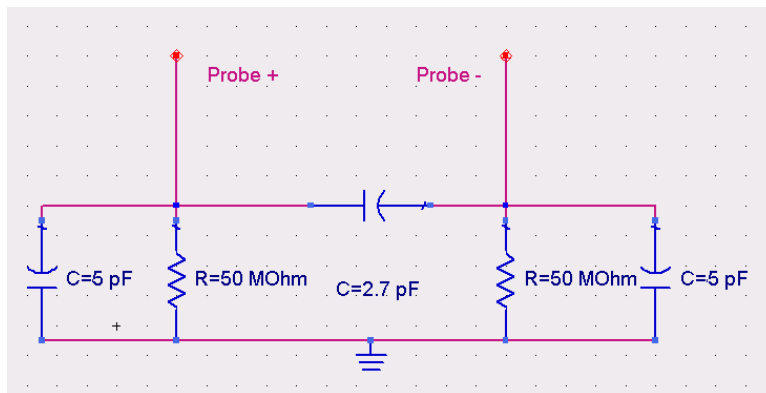
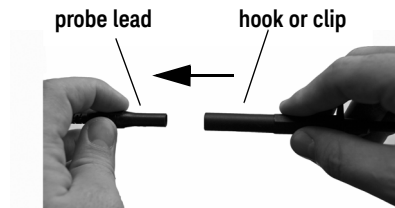

Figure 16 Input impedance equivalent circuit diagram

Using the Accessories

The accessories supplied with the N2791A and N2891A probes are attached by pushing them onto the probe leads as shown below.



The following accessories are supplied with the N2791A probe.

Safety Hook and Alligator Clips

Use the safety hooks to clamp onto smaller components and use the alligator clips to clamp onto thicker gauge devices.



safety hook



alligator clip

The following accessories are supplied with the N2891A probe and with the N2891-68700 Accessory Kit.

Safety Hook and High-Voltage Alligator Clips

Use the safety hooks to clamp onto smaller components and use the alligator clips to clamp onto thicker gauge devices



safety hook



high-voltage alligator clip

The following accessories are orderable with the N2791A probe.

Extreme Temperature Probing Kit

For extreme temperature probing, you can connect the N7013/14A extreme temperature probing kit to the N2791A probe. The N7013/14A extreme temperature probing kit is not compatible with the N2891A probe.

NOTE

The N7013/14A extreme temperature probing kit is not supplied with the probe. You can order this kit separately.

The N7013A extreme temperature probing kit includes:

- One pair of extreme temperature differential extension cables (black and red)
- One pair of extreme temperature hook tip adapters (black and red)
- One pair of extreme temperature banana-to-socketed tip adapters for connecting to 0.025" square pins (black and red)

The N7014A extreme temperature probing kit includes:

- One pair of extreme temperature banana-to-socketed tip adapters for connecting to 0.025" square pins (black and red)

CAUTION

Only the extension cables and the tip adapters provided with the cables are rated to extreme temperatures. The differential probe, original cables, and original accessories should not be exposed to extreme temperatures. When probing with the extension cables the bandwidth performance will be reduced, see [Table 2](#) on page 10.

Connecting the Extreme Temperature Probing Kit to the Probe

Perform the following steps to connect the N7013/14A extreme temperature kit to the N2791A probe:

- 1 Connect the red and black extreme temperature differential extension cables to the existing probe cables.

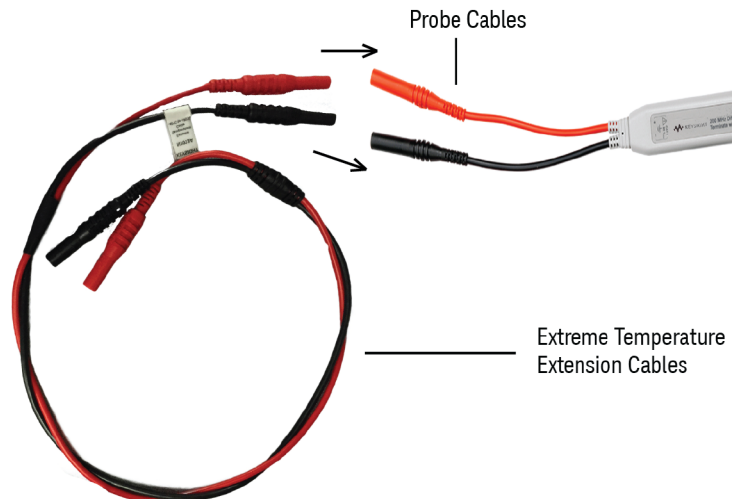

Figure 17 Connecting the Extreme Temperature Differential Extension Cables

- 2 Connect the red and black extreme temperature hook tip adapters to the extreme temperature differential extension cables which are already connected to the existing probe cables.

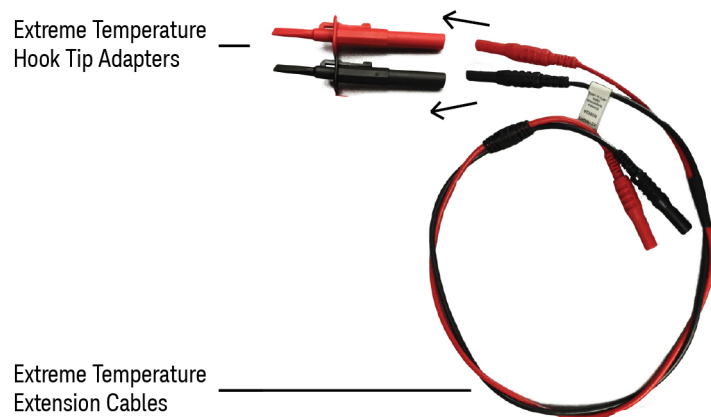

Figure 18 Connecting the Extreme Temperature Hook Tip Adapters

Or,

Connect the red and black extreme temperature banana-to-socketed tip adapters to the extreme temperature differential extension cables which are already connected to the existing probe cables.

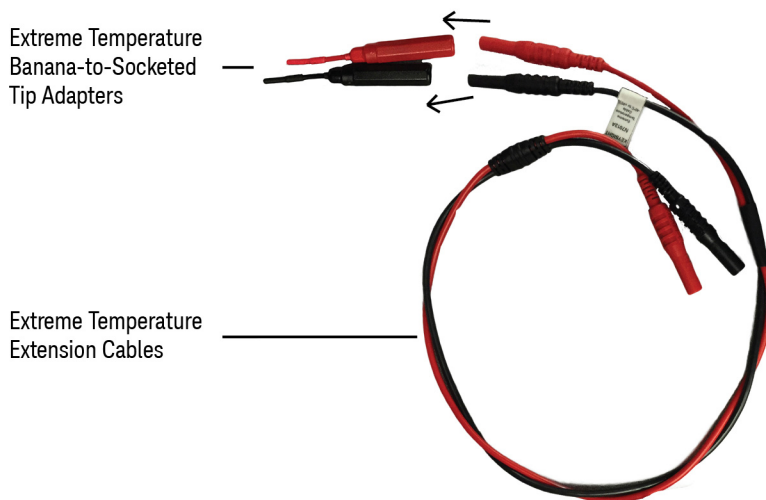

Figure 19 Connecting the Extreme Temperature Banana-to-Socketed Tip Adapters

N2791A Performance Verification Procedures

The following procedure can be used to test the DC differential gain accuracy and bandwidth of the N2791A differential probe. Please note that these procedures do not indicate that these characteristics are warranted. Instead, these procedures are meant to give you an idea of how your probe performs.

Table 6 Required Test Equipment

Description	Critical Specifications	Recommended Model Part Number	Functions
Digitizing Oscilloscope	Bandwidth: >50 MHz 1 M Ω /50 Ω selectable input	Keysight MS09254A	Display probe output
Signal Generator Precision DC voltage source	Amplitude accuracy: less than or equal to 0.25% 1 M Ω /50 Ω selectable load Sine wave greater than or equal to 25 MHz	Fluke 9500B	Signal source for DC gain and bandwidth
BNC Adapter	BNC (f) to Dual Banana (m) Adapter	Keysight 1251-2277	Interconnection between probe and generator
50 Ω BNC Feed Through Adapter	50 Ω precision feed through	Keysight 11048C	Termination between probe and calibrator for bandwidth verification

DC Differential Gain Accuracy

- 1 Set the volts/division on channel 1 of the oscilloscope to 20 mV/div. Set the seconds/div to 200 μ s and the acquisition mode to average 64.
- 2 Set the volts/division on channel 2 of the oscilloscope to 500 mV/div. Trigger on channel 2, select 50 Ω impedance.
- 3 Set the calibrator 9500B's channel 2 as the trigger channel (50 Ω load). Connect the calibrator's channel 2 active head to channel 2 of the oscilloscope.
- 4 Connect the active head channel 1 from the Fluke 9500B to channel 1 of the oscilloscope. Set the calibrator channel 1 to 0.1V peak-to-peak amplitude and 1 KHz (square wave, 1 M Ω load), enable the output.
- 5 Select the amplitude measurement on the oscilloscope and record the DC amplitude (approximately 100 mV) of the square wave. This measurement is only the oscilloscope.
- 6 Disable the Fluke calibrator output, disconnect the channel 1 active head from channel 1 of the oscilloscope.

- 7 Connect the output of the N2791A probe to channel 1 of the oscilloscope.
- 8 Attach the BNC adapter to the Fluke channel 1 active head.
- 9 Attach the differential probe input leads by clipping the alligator clamp to the BNC adapter banana post.
- 10 Set the probe to 100:1. Set the Fluke calibrator to 10 V and 1 KHz standard amplitude output (channel 1, square wave, 1 M Ω load).
- 11 Enable the output of the calibrator.
- 12 Record the DC amplitude of the square wave and divide 100 into just the amplitude of the oscilloscope. Verify that the probe gain accuracy is $\pm 2\%$ + scope gain accuracy.
- 13 Set the calibrator to 1 V output and set the attenuation button on the probe to 10:1.
- 14 Record the DC amplitude of the square wave and divide 10 into just the amplitude of the oscilloscope. Verify that the probe gain accuracy is $\pm 2\%$ + scope gain accuracy.
- 15 Disable the calibrator output and leave the setup connected for the next procedure.

Bandwidth

- 1 Connect the 50 Ω BNC feed through adapter to the calibrator's active head channel 1.
- 2 Attach the BNC (f)-to-banana post adapter to the BNC feed through adapter.
- 3 Attach the differential probe input leads by clipping the alligator clamp to the BNC adapter banana post.
- 4 Set the probe to 10:1 attenuation.
- 5 Set the volts/division on channel 1 of the oscilloscope to 50 mV/div and seconds/division to 50 ns/div. Set the trace to the center of the oscilloscope. Input impedance should be set to 1 M Ω . Set the average mode to 16 points.
- 6 Set the calibrator to sine wave, 3 V peak-to-peak amplitude. Set the frequency to 25 MHz, 50 Ω load.
- 7 Write down the peak-to-peak amplitude measured by the oscilloscope. It should be greater than or equal to 210 mV - scope vertical accuracy.
- 8 Disable the generator output and disconnect the probe input.

N2791A Performance Verification Test Record

Keysight Technologies Recommended Test Interval: 1 Year Recommended Date of Next Certification: _____ Certification Temperature: _____		N2791A 25 MHz Differential Probe Serial No.: _____ Certification Date: _____ Tested By: _____ _____ _____															
		<table border="1"> <thead> <tr> <th>Test</th> <th>Probe Settings</th> <th>Limits</th> <th>Results</th> </tr> </thead> <tbody> <tr> <td>Gain</td> <td>100:1</td> <td>98 mV to 102 mV</td> <td></td> </tr> <tr> <td>Gain</td> <td>10:1</td> <td>98 mV to 102 mV</td> <td></td> </tr> <tr> <td>Bandwidth</td> <td>10:1</td> <td>Greater than or equal to 210 mV - scope vertical accuracy</td> <td></td> </tr> </tbody> </table>	Test	Probe Settings	Limits	Results	Gain	100:1	98 mV to 102 mV		Gain	10:1	98 mV to 102 mV		Bandwidth	10:1	Greater than or equal to 210 mV - scope vertical accuracy
Test	Probe Settings	Limits	Results														
Gain	100:1	98 mV to 102 mV															
Gain	10:1	98 mV to 102 mV															
Bandwidth	10:1	Greater than or equal to 210 mV - scope vertical accuracy															

N2891A Performance Verification Procedures

The following procedure can be used to test and verify the DC differential gain accuracy and bandwidth of the N2891A high voltage differential probe. Please note that these procedures do not indicate that these characteristics are warranted. Instead, these procedures are meant to give you an idea of how your probe performs.

Table 7 Required Test Equipment

Description	Critical Specifications	Recommended Model Part Number	Functions
Digitizing Oscilloscope	Bandwidth: >50 MHz 1 M Ω /50 Ω selectable input	Keysight MS09254A	Display probe output
Signal Generator Precision DC voltage source	Amplitude accuracy: less than or equal to 0.25% 1 M Ω /50 Ω selectable load Sine wave greater than or equal to 25 MHz	Fluke 9500B	Signal source for DC gain and bandwidth
BNC Adapter	BNC (f) to Dual Banana (m) Adapter	Keysight 1251-2277	Interconnection between probe and generator
50 Ω BNC Feed Through Adapter	50 Ω precision feed through	Keysight 11048C	Termination between probe and calibrator for bandwidth verification

DC Differential Gain Accuracy

WARNING

Generator produces hazardous voltages. To avoid shock, do not touch exposed metal parts after generator output is enabled.

WARNING

These procedures require the application of high voltage to the inputs of the N2891A probe. Because this adapter has exposed metal surfaces, only qualified personnel should perform any testing with voltage levels exceeding 30 Vrms. All pertinent safety rules and guidelines for elevated voltage measurements should be followed and adhered to.

- 1 Set the volts/division on channel 1 of the oscilloscope to 20 mV/div. Set the seconds/div to 200 μ s and the acquisition mode to average 32.
- 2 Set the volts/division on channel 2 of the oscilloscope to 500 mV/div. Trigger on channel 2, select 50 Ω impedance.
- 3 Set the calibrator 9500B's channel 2 as the trigger channel (50 Ω load). Connect the calibrator's channel 2 active head to channel 2 of the oscilloscope.
- 4 Connect the active head channel 1 from the Fluke 9500B to channel 1 of the oscilloscope. Set the calibrator channel 1 to 0.1V peak-to-peak amplitude and 1 KHz (square wave, 1 M Ω load), enable the output.
- 5 Select the amplitude measurement on the oscilloscope and record the DC amplitude (approximately 100 mV) of the square wave. This measurement is only the oscilloscope.
- 6 Disable the Fluke calibrator output, disconnect the channel 1 active head from channel 1 of the oscilloscope.
- 7 Connect the output of the N2891A probe to channel 1 of the oscilloscope.
- 8 Attach the BNC adapter to the Fluke channel 1 active head.
- 9 Attach the differential probe input leads by clipping the alligator clamp to the BNC adapter banana post.
- 10 Set the probe to 100:1. Set the Fluke calibrator to 10 V and 1 KHz standard amplitude output (channel 1, square wave, 1 M Ω load).
- 11 Enable the output of the calibrator.
- 12 Record the DC amplitude of the square wave and divide 100 into just the amplitude of the oscilloscope. Verify that the probe gain accuracy is $\pm 2\%$ + scope gain accuracy.
- 13 Set the calibrator to 100 V output and set the attenuation button on the probe to 1000:1.
- 14 Record the DC amplitude of the square wave and divide 10 into just the amplitude of the oscilloscope. Verify that the probe gain accuracy is $\pm 2\%$ + scope gain accuracy.
- 15 Disable the calibrator output and leave the setup connected for the next procedure.

Bandwidth

- 1 Connect the 50 Ω BNC feed through adapter to the calibrator's active head channel 1.
- 2 Attach the BNC (f)-to-banana post adapter to the BNC feed through adapter.
- 3 Attach the differential probe input leads by clipping the alligator clamp to the BNC adapter banana post.
- 4 Set the probe to 100:1 attenuation.
- 5 Set the volts/division on channel 1 of the oscilloscope to 10 mV/div and seconds/division to 20 ns/div. Set the trace to the center of the oscilloscope. Input impedance should be set to 1 $M\Omega$. Disable average mode.
- 6 Set the calibrator to sine wave, 5 V peak-to-peak amplitude. Set the frequency to 70 MHz, 50 Ω load.
- 7 Write down the peak-to-peak amplitude measured by the oscilloscope. It should be greater than or equal to 35 mV - scope vertical accuracy.
- 8 Disable the generator output and disconnect the probe input.

N2891A Performance Verification Test Record

Keysight Technologies Recommended Test Interval: 1 Year Recommended Date of Next Certification: _____ Certification Temperature: _____		N2891A 70 MHz Differential Probe Serial No.: _____ Certification Date: _____ Tested By: _____ _____ _____															
		<table border="1"> <thead> <tr> <th>Test</th> <th>Probe Settings</th> <th>Limits</th> <th>Results</th> </tr> </thead> <tbody> <tr> <td>Gain</td> <td>100:1</td> <td>98 mV to 102 mV</td> <td></td> </tr> <tr> <td>Gain</td> <td>1000:1</td> <td>98 mV to 102 mV</td> <td></td> </tr> <tr> <td>Bandwidth</td> <td>10:1</td> <td>Greater than or equal to 35 mV - scope vertical accuracy</td> <td></td> </tr> </tbody> </table>	Test	Probe Settings	Limits	Results	Gain	100:1	98 mV to 102 mV		Gain	1000:1	98 mV to 102 mV		Bandwidth	10:1	Greater than or equal to 35 mV - scope vertical accuracy
Test	Probe Settings	Limits	Results														
Gain	100:1	98 mV to 102 mV															
Gain	1000:1	98 mV to 102 mV															
Bandwidth	10:1	Greater than or equal to 35 mV - scope vertical accuracy															

Offset Zero Calibration Procedure

The N2791A/N2891A differential probe can be adjusted for zeroing out the probe's offset voltage using the trimmer tool supplied with the probe. Follow this procedure to perform the offset zero calibration.

- 1 Connect the N2791A/N2891A probe to channel 1 of the scope. Turn on the probe power. You may use the USB power code or batteries to power the probe. Select the probe attenuation ratio to 10:1 (for N2791A) or 100:1 (for N2891A).
- 2 Short the + and - probe inputs together with the hook tips.
- 3 Turn on power to the oscilloscope and the probe, and leave them on for > 30 minutes so they can stabilize.
- 4 Press **[Default Setup]** and **[Auto Scale]** on the oscilloscope.
- 5 Press the channel 1 button, then press the Probe softkey, and then set the units to Volt and the probe attenuation to 10:1 (for N2791A) or 100:1 (for N2891A).
- 6 Set the scope to DC coupled mode and the scope offset to 0 Volt.
- 7 Set the oscilloscope to Averaging mode (x8 or higher) or high-resolution mode to reduce oscilloscope noise.
- 8 Using the trimmer tool that comes with the probe, adjust the probe offset voltage to 0 volts

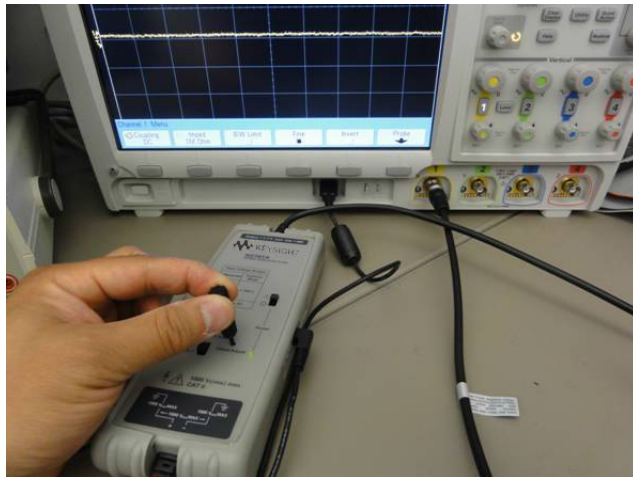



This information is subject to
change without notice.
© Keysight Technologies 2018
N2791-97008, December 2018
www.keysight.com

Distributed by:

Sie haben Fragen oder wünschen eine Beratung? Angebotsanfrage unter **07121 / 51 50 50** oder über **info@datatec.de**

dataTec