

Chroma

Regenerative Grid Simulator

61830/61845/61860

User's Manual

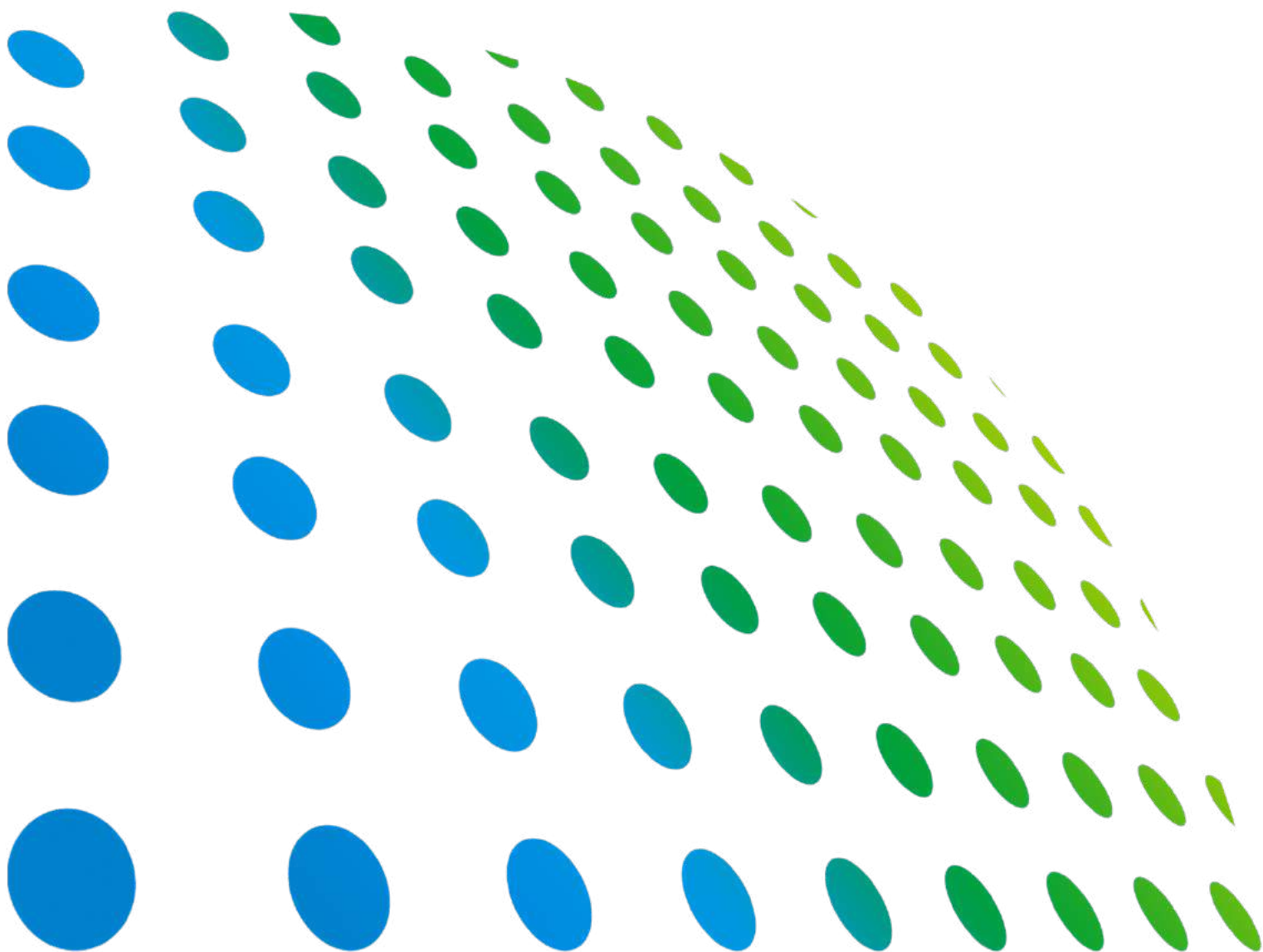

Distributed by:

Sie haben Fragen oder wünschen eine Beratung? Angebotsanfrage unter **07121 / 51 50 50** oder über info@datatec.de

dataTec

Get more information by downloading Chroma ATE Solutions APP



Regenerative Grid Simulator 61830/61845/61860 User's Manual

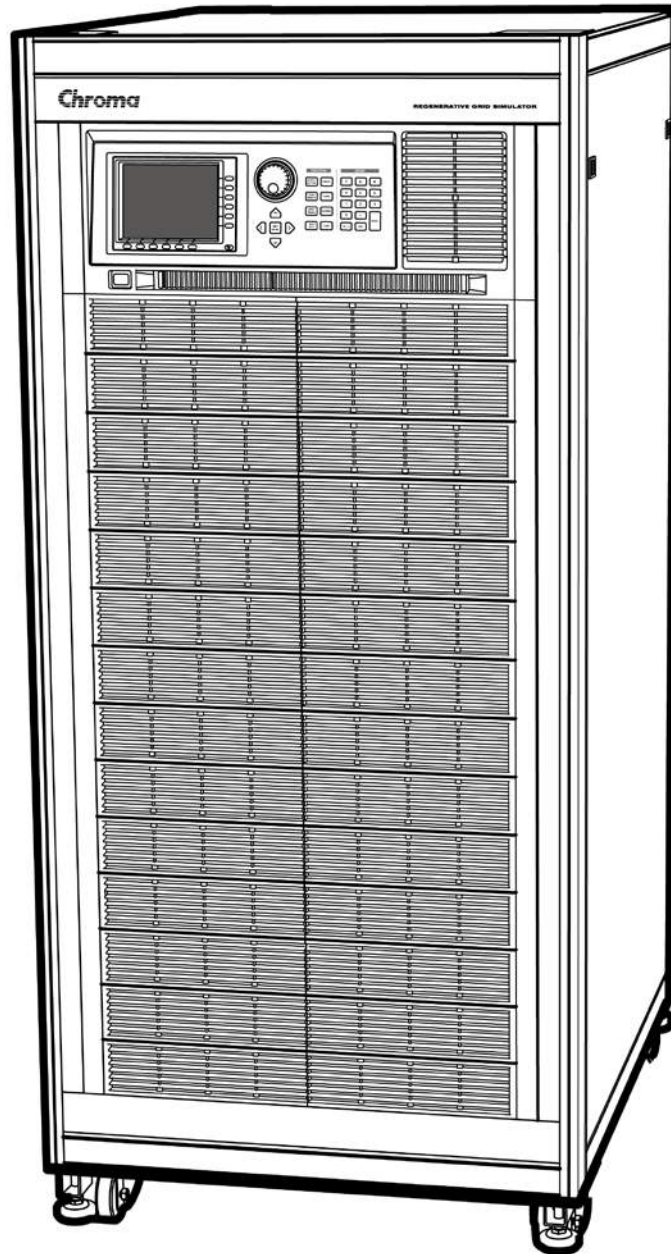

Version 1.7
April 2020

Legal Notices

The information in this document is subject to change without notice.

Chroma ATE INC. makes no warranty of any kind with regard to this manual, including, but not limited to, the implied warranties of merchantability and fitness for a particular purpose. Chroma ATE INC. shall not be held liable for errors contained herein or direct, indirect, special, incidental or consequential damages in connection with the furnishing, performance, or use of this material.

CHROMA ATE INC.

66 Huaya 1st Road, Guishan, Taoyuan 33383, Taiwan

Copyright Notices. Copyright 2013 Chroma ATE INC., all rights reserved. Reproduction, adaptation, or translation of this document without prior written permission is prohibited, except as allowed under the copyright laws.

Warranty

All of Chroma's instruments are warranted against defects in material and workmanship for a period of one year from date of shipment. Chroma agrees to repair or replace any assembly or component found to be defective, under normal use during this period. Chroma's obligation under this warranty is limited solely to repairing any such instrument, which in Chroma's sole opinion proves to be defective within the scope of the warranty when returned to the factory or to an authorized service center. Purchaser is responsible for the shipping and cost of the service item to Chroma factory or service center. Shipment should not be made without prior authorization by Chroma.

This warranty does not apply to any products repaired or altered by persons not authorized by Chroma, or not in accordance with instructions furnished by Chroma. If the instrument is defective as a result of misuse, improper repair, or abnormal conditions or operations, repairs will be billed at cost.

Chroma assumes no responsibility for its product being used in a hazardous or dangerous manner either alone or in conjunction with other equipment. High voltage used in some instruments may be dangerous if misused. Special disclaimers apply to these instruments. Chroma assumes no liability for secondary charges or consequential damages and in any event, Chroma's liability for breach of warranty under any contract or otherwise, shall not exceed the purchase price of the specific instrument shipped and against which a claim is made.

Any recommendations made by Chroma regarding the use of its products are based upon tests believed to be reliable; Chroma makes no warranty of the results to be obtained. This warranty is in lieu of all other warranties, expressed or implied, and no representative or person is authorized to represent or assume for Chroma any liability in connection with the sale of our products other than set forth herein.

CHROMA ATE INC.

66 Huaya 1st Road, Guishan,
Taoyuan 33383, Taiwan
Tel: 886-3-327-9999
Fax: 886-3-327-8898
e-mail: info@chromaate.com

<http://www.chromaate.com>

Material Contents Declaration

The recycling label shown on the product indicates the Hazardous Substances contained in the product as the table listed below.



: See <Table 1>.



: See <Table 2>.

<Table 1>

Part Name	Hazardous Substances					
	Lead	Mercury	Cadmium	Hexavalent Chromium	Polybrominated Biphenyls/ Polybromodiphenyl Ethers	Selected Phthalates Group
	Pb	Hg	Cd	Cr ⁶⁺	PBB/PBDE	DEHP/BBP/DBP/DIBP
PCBA	O	O	O	O	O	O
CHASSIS	O	O	O	O	O	O
ACCESSORY	O	O	O	O	O	O
PACKAGE	O	O	O	O	O	O

“O” indicates that the level of the specified chemical substance is less than the threshold level specified in the standards of SJ/T-11363-2006, EU Directive 2011/65/EU, and 2015/863/EU.

“X” indicates that the level of the specified chemical substance exceeds the threshold level specified in the standards of SJ/T-11363-2006, EU Directive 2011/65/EU, and 2015/863/EU.

Remarks:

1. The CE marking on product is a declaration of product compliance with EU Directive 2011/65/EU and 2015/863/EU.
2. This product is complied with EU REACH regulation and no SVHC in use.

Disposal

Do not dispose of electrical appliances as unsorted municipal waste, use separate collection facilities. Contact your local government for information regarding the collection systems available. If electrical appliances are disposed of in landfills or dumps, hazardous substances can leak into the groundwater and get into the food chain, damaging your health and well-being. When replacing old appliances with new one, the retailer is legally obligated to take back your old appliances for disposal at least for free of charge.



<Table 2>

Part Name	Hazardous Substances					
	Lead	Mercury	Cadmium	Hexavalent Chromium	Polybrominated Biphenyls/ Polybromodiphenyl Ethers	Selected Phthalates Group
	Pb	Hg	Cd	Cr ⁶⁺	PBB/PBDE	DEHP/BBP/DBP/DIBP
PCBA	×	○	○	○	○	○
CHASSIS	×	○	○	○	○	○
ACCESSORY	×	○	○	○	○	○
PACKAGE	○	○	○	○	○	○

“O” indicates that the level of the specified chemical substance is less than the threshold level specified in the standards of SJ/T-11363-2006, EU Directive 2011/65/EU, and 2015/863/EU.

“×” indicates that the level of the specified chemical substance exceeds the threshold level specified in the standards of SJ/T-11363-2006, EU Directive 2011/65/EU, and 2015/863/EU.

1. Chroma is not fully transitioned to lead-free solder assembly at this moment; however, most of the components used are RoHS compliant.
2. The environment-friendly usage period of the product is assumed under the operating environment specified in each product's specification.
3. This product is complied with EU REACH regulation and no SVHC in use.

Disposal

Do not dispose of electrical appliances as unsorted municipal waste, use separate collection facilities. Contact your local government for information regarding the collection systems available. If electrical appliances are disposed of in landfills or dumps, hazardous substances can leak into the groundwater and get into the food chain, damaging your health and well-being. When replacing old appliances with new one, the retailer is legally obligated to take back your old appliances for disposal at least for free of charge.





Declaration of Conformity

For the following equipment :

Regenerative Grid Simulator

(Product Name/ Trade Name)

61860, 61845, 61830, 61860HV, 61845HV, 61830HV

(Model Designation)

CHROMA ATE INC.

(Manufacturer Name)

66 Huaya 1st Road, Guishan, Taoyuan 33383, Taiwan

(Manufacturer Address)

Is herewith confirmed to comply with the requirements set out in the Council Directive on the Approximation of the Laws of the Member States relating to Electromagnetic Compatibility (2014/30/EU) and Low Voltage Directive (2014/35/EU). For the evaluation regarding the Directives, the following standards were applied:

EN 61326-1:2013, EN 61326-2-2:2013

CISPR11:2009+A1:2010, Group1, Class A, EN 61000-3-12:2011, EN 61000-3-11:2000,
IEC 61000-4-2:2008 ED2.0, IEC 61000-4-3:2010 ED3.2, IEC 61000-4-4:2012 ED3.0,
IEC 61000-4-5:2005 ED2.0, IEC 61000-4-6:2013 ED4.0, IEC 61000-4-8:2009 ED2.0,
IEC 61000-4-11:2004 ED2.0

EN 61010-1:2010

The equipment describe above is in conformity with Directive 2011/65/EU of the European Parliament and of the Council of 8 June 2011 on the restriction of the use of certain hazardous substances in electrical and electronic equipment.

The following importer/manufacturer or authorized representative established within the EUT is responsible for this declaration :

CHROMA ATE INC.

(Company Name)

66 Huaya 1st Road, Guishan, Taoyuan 33383, Taiwan

(Company Address)

Person responsible for this declaration:

Mr. Vincent Wu

(Name, Surname)

T&M BU Vice President

(Position/Title)

Taiwan

(Place)

2017.02.21

(Date)

(Legal Signature)

Safety Summary

The following general safety precautions must be observed during all phases of operation, service, and repair of this instrument. Failure to comply with these precautions or specific WARNINGS given elsewhere in this manual will violate safety standards of design, manufacture, and intended use of the instrument. *Chroma* assumes no liability for the customer's failure to comply with these requirements.



BEFORE APPLYING POWER

Verify that the power is set to match the rated input of this power supply.



PROTECTIVE GROUNDING

Make sure to connect the protective grounding to prevent an electric shock before turning on the power.



NECESSITY OF PROTECTIVE GROUNDING

Never cut off the internal or external protective grounding wire, or disconnect the wiring of protective grounding terminal. Doing so will cause a potential shock hazard that may bring injury to a person.



FUSES

Only fuses with the required rated current, voltage, and specified type (normal blow, time delay, etc.) should be used. Do not use repaired fuses or short-circuited fuse holders. To do so could cause a shock or fire hazard.



DO NOT OPERATE IN AN EXPLOSIVE ATMOSPHERE

Do not operate the instrument in the presence of flammable gases or fumes. The instrument should be used in an environment of good ventilation.



DO NOT REMOVE THE COVER OF THE INSTRUMENT

Operating personnel must not remove the cover of the instrument. Component replacement and internal adjustment can be done only by qualified service personnel.



DO NOT MOVE THE EQUIPMENT ON SLOPE PAVEMENT

Do not move the equipment on slope pavement when changing the location. Be sure to use foot pads to stabilize the equipment when positioning it.

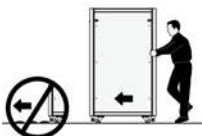













DO NOT MOVE THE EQUIPMENT ON BUMPY PAVEMENT

Do not move the equipment on bumpy pavement when changing the location. Be sure to use foot pads to stabilize the equipment when positioning it.

WARNING

1. Lethal voltage, the output is up to 426V peak voltage.
2. If the output terminal and circuit are connected to output when the power is on, it could cause death if touches it.
3. Please make sure the floor is flat and endurable for maximum weight before placing the device. Please install it close to the primary structure (beams).
4. The load bearing of each foot pad is about 250kg. Considering the floor structure, it is suggested to use an iron plate of 350mm/350mm/10t to disperse the pressure.

Safety Symbols

	DANGER – High voltage.
	Explanation: To avoid injury, death of personnel, or damage to the instrument, the operator must refer to an explanation in the instruction manual.
	High temperature: This symbol indicates the temperature is now higher than the acceptable range of human. Do not touch it to avoid any personal injury.
	Protective grounding terminal: To protect against electrical shock in case of a fault. This symbol indicates that the terminal must be connected to ground before operation of equipment.
	Functional grounding: To identify an earth (ground) terminal in cases where the protective ground is not explicitly stated. This symbol indicates the power connector does not provide grounding.
	Frame or chassis: To identify a frame or chassis terminal.
	Alternating Current (AC)
	Direct Current (DC) / Alternating Current (AC)
	Direct Current (DC)
	Push-on/Power switch
	The WARNING sign denotes a hazard. It calls attention to a procedure, practice, or the like, which, if not correctly performed or adhered to, could result in personal injury. Do not proceed beyond a WARNING sign until the indicated conditions are fully understood and met.
	The CAUTION sign denotes a hazard. It may result in personal injury or death if not noticed timely. It calls attention to procedures, practices and conditions.
	The Notice sign denotes important information in procedures, applications or the areas that require special attention. Be sure to read it carefully.

Moving the Device

Since the device weighs heavy, for your safety be sure to use tool to move it in accordance with the following figure.

搬运注意
CAUTION

1

1. 依据板车规格选择搬运方法。
2. 板车载重须大于1500kg。
3. 板车前脚踏须穿鞋并超过柜体。
4. 使用时请对应左图图形进行液压板车操作，面积 A 两边需相等，以确保重心位置符合要求。
5. 滚动路面与坡道上禁止用液压板车搬运。
6. 禁止在斜坡、震动和崎岖路面移动机器，机器定位后须将脚垫固定。

2

1. Select an appropriate moving method based on the pallet jack in use.
2. The pallet jack must have a load capacity of 1500kg or more.
3. The pallet jack forks length should exceed the device cabinet.
4. When operating the pallet jack by the method shown on the left, make sure the areas of both A sections are the same to maintain maximum stability.
5. Do not use pallet jack to move the device on bumpy and sloping road.
6. Do not move the equipment on sloping, rough, or bumpy pavement. Be sure to use footpads to stabilize the equipment when positioning it.

承载限制注意
CAUTION

1. 本体落地面积780 x 1000(mm)，重量1120 kg，应确认放置地板是否平整以及可承受的最大重量，并安装靠近主结构(梁柱)。
2. 每一承载脚垫约承受300kg，考量地板结构，建议使用400mm/400mm/10t的铁板分散压力。

1. Dimension: 780 x 1000 (mm), weight: 1120 kg. Make sure the floor surface is smooth and the weight is bearable. Install the equipment near the main structure (beams).
2. Each footpad can stand about 300kg. Considering the floor structure, it is recommended to use an iron plate of 400mm/400mm/10t to disperse the pressure.

The instrument must place horizontally during transportation and use. It is strictly forbidden to slant the device, or it may cause the device to be damaged.

Cleaning

It is suggested to regularly perform internal cleaning and maintenance. The standard period is 1 year. Due to different environment use conditions, the maintenance period can be adjusted according to your use environment. Please contact your local technical service personnel for related service requirements.

Revision History

The following lists the additions, deletions and modifications in this manual at each revision.

Date	Version	Revised Sections
Nov. 2013	1.0	Complete this manual.
Sep. 2014	1.1	Replace the screen figures in the manual. Add a new " <i>Parallel Operation</i> " chapter. Modify the commands in " <i>Commands of Regenerative Grid Simulator</i> " section in " <i>Remote Operation</i> " chapter.
Apr. 2015	1.2	Replace the screen figures in the manual. Modify the following sections: <ul style="list-style-type: none"> – "<i>Specification</i>" in "<i>Overview</i>" chapter. – "<i>MAIN PAGE (for Output Setting and Measurement)</i>", "<i>CONFIG Function Key</i>" and "<i>Protection</i>" in "<i>Local Operation</i>" chapter. – "<i>Introduction</i>" in "<i>Calibration</i>" chapter. – "<i>List Mode</i>" and "<i>Pulse Mode</i>" in "<i>Application</i>" chapter. – "<i>Commands of Regenerative Grid Simulator</i>" in "<i>Remote Operation</i>" chapter.
Nov. 2015	1.3	Add a new model 61830 and its specifications.
Oct. 2016	1.4	Update CE " <i>Declaration of Conformity</i> ".
Apr. 2017	1.5	Update " <i>Material Contents Declaration</i> ". Update CE " <i>Declaration of Conformity</i> ". Add cables connection for paralleling five units and the specifications.
Jan. 2018	1.6	Update " <i>Protection</i> " section in " <i>Local Operation</i> " chapter. Update ACL mode and its functions descriptions as option. Add " <i>Load Mode</i> " chapter and ACL subsystem related description in " <i>Instrument Command Dictionary</i> " section.
Apr. 2020	1.7	Modify the following: <ul style="list-style-type: none"> – "<i>Specification</i>" and "<i>Rear Panel</i>" in "<i>Overview</i>" chapter – "<i>Connecting Remote Sense</i>" in "<i>Installation</i>" chapter – "<i>Parallel/Series (Optional) Operation</i>" chapter – "<i>Instrument Command Dictionary</i>" and "<i>Command Summary</i>" in "<i>Remote Operation</i>" chapter Add <ul style="list-style-type: none"> – Moving and cleaning description – "<i>Series Connection for Regenerative Grid Simulators (Optional)</i>" and "<i>Signal Cable Connection for Series Mode (Optional)</i>" to "<i>Parallel/Series (Optional) Operation</i>" chapter

Table of Contents

1.	Overview	1-1
1.1	Introduction	1-1
1.2	Feature	1-1
1.3	Specification.....	1-1
1.4	Function Keys	1-8
1.4.1	Front Panel.....	1-8
1.4.2	Rear Panel	1-10
2.	Installation	2-1
2.1	Initial Inspection	2-1
2.2	Precautions before Use.....	2-1
2.3	Input Power Specification	2-1
2.3.1	Ratings.....	2-1
2.3.2	Connecting for Input	2-2
2.4	Output Connection	2-3
2.5	Connecting Remote Sense	2-3
2.6	Power-On Procedure	2-6
2.7	Maintenance and Cleaning.....	2-6
2.8	Common Environment Conditions	2-7
3.	Local Operation.....	3-1
3.1	Introduction	3-1
3.2	Using Keyboard and RPG	3-1
3.3	MAIN PAGE (for Output Setting and Measurement).....	3-3
3.3.1	OUTPUT: More Setting	3-5
3.3.2	Measurement Setting	3-15
3.3.3	Waveform Viewer	3-18
3.3.4	Limitation.....	3-19
3.4	CONFIG Function Key	3-22
3.4.1	Interface	3-23
3.4.2	External Vref	3-27
3.4.3	Display	3-28
3.4.4	Power ON Status.....	3-29
3.4.5	Protection	3-30
3.4.6	Others	3-31
3.4.7	Calibration	3-33
3.4.8	System Information	3-33
3.4.9	Factory Default	3-34
3.5	PHASE Function Key	3-34
3.5.1	3_Phase Mode	3-34
3.5.2	1_Phase Mode	3-35
3.6	CURSOR Function Key.....	3-36
3.7	LOCK Function Key	3-36
3.8	OUTPUT Function Key.....	3-37
3.9	LOCAL/REMOTE Function Key	3-37
3.10	SAVE/RECALL Function Key.....	3-37
3.10.1	Save/Recall Output Setting.....	3-37
3.10.2	Save/Recall System Data.....	3-38
3.11	Protection.....	3-39
4.	Calibration	4-1
4.1	Introduction	4-1

4.2	Manual Calibration Function.....	4-2
4.2.1	Calibrating Output Voltage and Voltage Measurement	4-3
4.2.2	Calibrating Current Measurement.....	4-7
4.2.3	Calibrating External Vref.....	4-12
4.3	Adjusting Response Speed	4-15
5.	Application	5-1
5.1	Overview	5-1
5.2	List Mode	5-1
5.3	Pulse Mode	5-6
5.4	Step Mode.....	5-10
5.5	Synthesis Waveform	5-13
5.6	Inter-harmonics Waveform	5-17
5.7	Harmonic Waveform	5-20
6.	Parallel/Series (Optional) Operation	6-1
6.1	Parallel Connection for Regenerative Grid Simulator	6-1
6.1.1	Connecting Two Parallel Units for Output	6-1
6.1.2	Connecting Two Parallel Units for Input.....	6-1
6.1.3	Connecting Three Parallel Units for Output	6-2
6.1.4	Connecting Three Parallel Units for Input	6-3
6.1.5	Connecting Four or Five Parallel Units for Output.....	6-3
6.1.6	Connecting Four or Five Parallel Units for Input	6-4
6.2	Series Connection for Regenerative Grid Simulators (Optional)	6-4
6.2.1	Connecting Two Simulators at Output in Series.....	6-4
6.3	Cables Connection for Parallel Signal	6-6
6.3.1	Cables Connection for Paralleling Two Units	6-6
6.3.2	Cables Connection for Paralleling Three Units	6-6
6.3.3	Cables Connection for Paralleling Four Units	6-7
6.3.4	Cables Connection for Paralleling Five Units.....	6-7
6.4	Signal Cable Connection for Series Mode (Optional)	6-7
6.4.1	Connecting Cable for Two Units	6-7
6.5	Setting.....	6-8
6.5.1	Setting Regenerative Grid Simulator to Slave.....	6-8
6.5.2	Setting Regenerative Grid Simulator to Master.....	6-8
6.6	Troubleshooting	6-9
6.6.1	When the Connecting Cable is Off.....	6-9
7.	AC Load Mode (Option)	7-1
7.1	Switching to Load Mode	7-1
7.2	Load Function Interface.....	7-1
7.2.1	CC Rectifier Mode	7-1
7.2.2	CP Rectifier Mode	7-2
7.2.3	CR Mode	7-2
7.2.4	CC Lead/Lag Mode	7-3
7.2.5	CP Lead/Lag Mode	7-3
8.	Remote Operation	8-1
8.1	Introduction	8-1
8.1.1	USB Interface	8-1
8.1.2	GPIB Interface.....	8-1
8.1.3	RS-232C Interface.....	8-2
8.1.4	Ethernet Interface	8-2
8.2	Introduction to Programming	8-2
8.2.1	Conventions	8-3
8.2.2	Numerical Data Formats.....	8-3

8.2.3	Boolean Data Format	8-3
8.2.4	Character Data Format.....	8-3
8.2.5	Basic Definition.....	8-3
8.3	Traversal of the Command Tree.....	8-5
8.4	Commands of Regenerative Grid Simulator	8-5
8.4.1	Common Command Dictionary.....	8-5
8.4.2	Instrument Command Dictionary	8-6
8.5	Command Summary	8-36
Appendix A	TTL Signal Pin Assignments	A-1
Appendix B	Built-in DST Waveform	B-1

1. Overview

1.1 Introduction

The distributed power grids of today such as solar power and wind power generation are growing gradually. To cope with this trend, the equipment manufacturers have to follow the standards (IEEE 1547 / IEC 61000-3-15 / IEC 62116 for instance) to perform the tests and certify their equipment meets the standard. The Chroma 61800 Series Regenerative Grid Simulator released lately can provide the test solutions required for parallel grids. Its full four quadrant operation, energy recycling and voltage waveform editing functions (such as the simulation of voltage fall and harmonic distortion) are in compliance with the standard. Most importantly, the 61800 Series provides an effective energy saving solution that can feed the energy generated during testing back to the grid instead of consuming it as heat energy. Besides the distributed power test application, the 61800 Series Regenerative Grid Simulation can also apply to other green products associate tests like Vehicle to Grid (V2G) and Energy Saving System (ESS).

1.2 Feature

- Voltage: 0~300V
- Frequency: DC, 30Hz~100Hz
- Energy regenerative function with 100% rated current recycling capability
- Conform with the test applications of PV inverter, Smart Grid and EV associate products
- Selectable 1-phase/3-phase AC output
- Controllable voltage and frequency for change rate
- Output limit setting for voltage and current
- Voltage waveform setting for 0~360 switching degree
- Sync TTL signal Output for changed voltage
- LIST, STEP, PULSE mode for Power Line Disturbance (PLD) simulation
- Voltage interruption/transient simulation (conform with LVRT test)
- Distortion waveform synthesis of harmonics and interharmonics
- Parameter measurement functions including step of harmonic current
- Programmable analog interface
- Digital interface: GPIB, RS-232, USB and Ethernet
- Parallel mode support for high power output (valid for 3-phase only)

1.3 Specification

The following table lists the specification of Chroma 61830/61845/61860 Regenerative Grid Simulator. All specifications are verified in accordance with Chroma's standard test procedure. Unless otherwise specified, all specifications are tested under the condition of remote connected voltage sense within the temperature of $25 \pm 1^\circ\text{C}$ and load resistance.

Model	61830	61845	61860
AC Output Rating			
1-Phase Power	30kVA	45kVA	60kVA
3-Phase Total Power	30kVA	45kVA	60kVA
Power per Phase	10kVA	15kVA	20kVA
Voltage			
Output Voltage	0~300V _{LN} Option-HV:0~400V _{LN}		
Accuracy ^{*1}	0.1%+0.2%F.S.		
Resolution	0.1 V		
Distortion ^{*1*2}	< 0.5% @50/60Hz < 0.8% @30Hz~100Hz (Option-HV up to 150Hz)	< 0.5% @50/60Hz < 0.8% @30Hz~100Hz (Option-HV up to 150Hz)	< 0.5% @50/60Hz < 0.8% @30Hz~100Hz (Option-HV up to 150Hz)
Line Regulation	0.10%		
Load Regulation ^{*3}	0.20%		
Maximum Current (1-Phase)^{*4}			
Output Current (RMS)	150A	225A	300A
Output Current (Peak)	450A	675A	900A
Maximum Current (3-Phase/per phase)^{*5}			
Output Current (RMS)	50A	75A	100A
Output Current (Peak)	150A	225A	300A
Frequency			
Range	DC, 30Hz ~ 100Hz Option-HV: DC, 30~150Hz		
Accuracy ^{*1}	0.01%F.S	0.01% F.S	0.01% F.S
Resolution	0.01Hz	0.01Hz	0.01HZ
DC Output Rating (1-Phase)^{*4}			
Power	15kW	22.5kW	30kW
Voltage ^{*6}	424V Option-HV:565V	424V Option-HV:565V	424V Option-HV:565V
Current	75A	112.5A	150A
DC Output Rating (3-Phase/per phase)^{*7}			
Power	5kW	7.5kW	10kW
Voltage ^{*6}	424V Option-HV:565V	424V Option-HV:565V	424V Option-HV:565V
Current	25A	37.5A	50A
Energy Recycling Function			
Current Harmonic Distortion ^{*8}	10%(Typical)	7%(Typical)	5%(Typical)
Power Factor	0.97 (Typical)		
Input 3-Phase Rating (Each Phase)			
Voltage Range ^{*9}	3Ø 200-220V±10%V _{LL} 3Ø 380-400V±10%V _{LL} 3Ø 440-480V±10%V _{LL}		
Frequency Range	47-63 Hz		
Maximum Current	125A Max./Phase	190A Max./Phase	250A Max./Phase

Model	61830	61845	61860
	(3Ø200-220V±10%V _{LL}) 68A Max./Phase (3Ø 380-400V±10%V _{LL}) 60A Max./Phase (3Ø 440-480V±10%V _{LL})	(3Ø 200-220V±10%V _{LL}) 100A Max./Phase (3Ø 380-400V±10%V _{LL}) 87A Max./Phase (3Ø 440-480V±10%V _{LL})	(3Ø 200-220V±10%V _{LL}) 130A Max./Phase (3Ø 380-400V±10%V _{LL}) 115A Max./Phase (3Ø 440-480V±10%V _{LL})
Power Factor	0.99 (Typical)		
Measurement			
Voltage			
Range	0~300V _{LN} Option-HV:0~400V _{LN}		
Accuracy	0.1%+0.2%F.S.		
Resolution	0.01 V		
Current^{*10} (Each Phase)			
Range	150A	225A	300A
Accuracy (RMS) ^{*11}	0.4%+0.3%F.S.		
Accuracy (Peak) ^{*11}	0.4%+0.6%F.S.		
Resolution ^{*12}	0.01 A		
Power			
Accuracy	0.4%+0.4% F.S.		
Resolution	0.1 W		
Others			
Efficiency ^{*13}	80%(Typical)		
Dimension (W×D×H)	780 x 1000 x 1740 mm 30.70×39.37×68.50 in.	780 x 1000 x 1740 mm 30.70×39.37×68.50 in.	780 x 1000 x 1740 mm 30.70×39.37×68.50 in.
Weight	840kg / 1850 lbs	840kg / 1850 lbs	860kg / 1896 lbs
Protection	OVP, OCP, OPP, OTP, FAN		
Remote Interface	GPIB, RS-232, USB, Ethernet		
Temperature Range			
Operating	0°C to 40°C		
Storage	-40°C to 85°C		
Humidity ^{*14}	0% to 95%		
Safety & EMC	CE		

Regenerative AC Load (ACL Option)

Model	61830	61845	61860
Loading Current (Each Phase)			
Current	50A	75A	100A
Max. Current	150A _{peak}	225A _{peak}	300A _{peak}
Operating Voltage			
Range	50~300V _{LN} Option-HV: 50~400V _{LN}		
Max. Voltage	424V _{peak} Option-HV: 566V _{peak}		
Operating Frequency			
Range	30Hz ~ 100Hz		
Accuracy	0.01%		
Resolution	0.1Hz		

Constant Current Rectifier Mode (Each Phase)			
Current Range	0~50A	0~75A	0~100A
Accuracy	0.3% + 0.5%F.S. (above 2A) Option-HV: 0.3% + 0.7%F.S. (above 2A)	0.3% + 0.5%F.S. (above 2A) Option-HV: 0.3% + 0.7%F.S. (above 2A)	0.3% + 0.5%F.S. (above 2A) Option-HV: 0.3% + 0.7%F.S. (above 2A)
Resolution	0.1A	0.1A	0.1A
Crest Factor Range	1.414~3.0	1.414~3.0	1.414~3.0
Crest Factor Resolution	0.001	0.001	0.001
Constant Power Rectifier Mode (Each Phase)			
Power Range	0~10kW	0~15kW	0~20kW
Accuracy	0.3% + 0.6%F.S. (above 200W) Option-HV: 0.3% + 0.7%F.S. (above 200W)	0.3% + 0.6%F.S. (above 200W) Option-HV: 0.3% + 0.7%F.S. (above 200W)	0.3% + 0.6%F.S. (above 200W) Option-HV: 0.3% + 0.7%F.S. (above 200W)
Resolution	10W	10W	10W
Crest Factor Range	1.414~3.0	1.414~3.0	1.414~3.0
Crest Factor Resolution	0.001	0.001	0.001
Constant Current Phase Change Mode (Each Phase)			
Current Range	0~50A	0~75A	0~100A
Accuracy	0.3% + 0.5%F.S. (above 2A) Option-HV: 0.3% + 0.7%F.S. (above 2A)	0.3% + 0.5%F.S. (above 2A) Option-HV: 0.3% + 0.7%F.S. (above 2A)	0.3% + 0.5%F.S. (above 2A) Option-HV: 0.3% + 0.7%F.S. (above 2A)
Resolution	0.1A	0.1A	0.1A
Phase Range	-45deg ~ 0deg & +45deg ~ 0deg (current source mode +135deg ~ +180deg & -135deg ~ -180deg)	-45deg ~ 0deg & +45deg ~ 0deg (current source mode +135deg ~ +180deg & -135deg ~ -180deg)	-45deg ~ 0deg & +45deg ~ 0deg (current source mode +135deg ~ +180deg & -135deg ~ -180deg)
Accuracy ^{*16}	0.6%F.S.(30~70Hz) 1.0%F.S.(71Hz~100Hz)	0.6%F.S.(30~70Hz) 1.0%F.S.(71Hz~100Hz)	0.6%F.S.(30~70Hz) 1.0%F.S.(71Hz~100Hz)
Resolution	0.1deg	0.1deg	0.1deg
Constant Power Phase Change Mode (Each Phase)			
Power Range	0~10kW	0~15kW	0~20kW
Accuracy	0.3% + 0.6%F.S. (above 200W) Option-HV: 0.3% + 0.7%F.S. (above 200W)	0.3% + 0.6%F.S. (above 200W) Option-HV: 0.3% + 0.7%F.S. (above 200W)	0.3% + 0.6%F.S. (above 200W) Option-HV: 0.3% + 0.7%F.S. (above 200W)
Resolution	10W	10W	10W
Phase Range	-90deg ~ +90deg (current mode +90.1deg ~ +180deg & -90.1deg ~ -180deg)	-90deg ~ +90deg (current mode +90.1deg ~ +180deg & -90.1deg ~ -180deg)	-90deg ~ +90deg (current mode +90.1deg ~ +180deg & -90.1deg ~ -180deg)

Accuracy ^{*16}	0.6%F.S.(30~60Hz) 0.8%F.S.(61Hz~100Hz)	0.6%F.S.(30~60Hz) 0.8%F.S.(61Hz~100Hz)	0.6%F.S.(30~60Hz) 0.8%F.S.(61Hz~100Hz)
Resolution	0.1deg	0.1deg	0.1deg
Constant Resistance Mode (Each Phase)			
Range	1~300ohm	1~300ohm	1~300ohm
Accuracy	Convert to current value 0.3% + 0.7%F.S. (above 2A) Option-HV: 0.3% + 0.9%F.S. (above 2A)	Convert to current value 0.3% + 0.7%F.S. (above 2A) Option-HV: 0.3% + 0.9%F.S. (above 2A)	Convert to current value 0.3% + 0.7%F.S. (above 2A) Option-HV: 0.3% + 0.9%F.S. (above 2A)
Resolution	0.1ohm	0.1ohm	0.1ohm
Current Harmonic	<3% (Full load at 250V/50Hz/sinewave)	<3% (Full load at 250V/50Hz/sinewave)	<3% (Full load at 250V/50Hz/sinewave)

120kVA 800VLN Series High Voltage Function (XHV Option)

AC Output Rating	
3-Phase Total Power	120kVA
Power per Phase	40KVA
Voltage	
Output Voltage	0~800V _{LN}
Accuracy ^{*1}	0.1%+0.2%F.S.
Resolution	0.1 V
Distortion ^{*1*2}	< 0.8% @50/60Hz < 1.0% @30Hz~150Hz
Line Regulation	0.10%
Load Regulation ^{*3}	0.20%
Maximum Current (3-Phase/per phase) ^{*5}	
Output Current (RMS)	100A
Output Current (Peak)	300A
Frequency	
Range	DC, 30Hz ~ 150Hz
Accuracy ^{*1}	0.01% F.S.
Resolution	0.01Hz
DC Output Rating (3-Phase/per phase) ^{*7}	
Power	20kW
Voltage ^{*6}	1131V
Current	50A
Energy Recycling Function	
Current Harmonic Distortion ^{*8}	5%(Typical)
Power Factor	0.97 (Typical)
Input 3-Phase Rating (Each Phase)	
Voltage Range ^{*9}	3Ø 200-220V±10%V _{LL} 3Ø 380-400V±10%V _{LL} 3Ø 440-480V±10%V _{LL}

Frequency Range	47-63 Hz
Maximum Current	250A Max./Phase (3Ø 200-220V±10%V _{LL})130A Max./Phase (3Ø 380-400V±10%V _{LL}) 115A Max./Phase (3Ø 440-480V±10%V _{LL})
Power Factor	0.99 (Typical)
Measurement	
Voltage	
Range	0~800V _{LN}
Accuracy	0.1%+0.2%F.S.
Resolution	0.01 V
Current ¹⁰ (Each phase)	
Range	300A
Accuracy (RMS) ^{*11}	0.4%+0.3%F.S.
Accuracy (Peak) ^{*11}	0.4%+0.6%F.S.
Resolution ^{*12}	0.01 A
Power	
Accuracy	0.4%+0.4% F.S.
Resolution	0.1 W
Others	
Efficiency ^{*13}	80%(Typical)
Dimension (W×D×H)	1700 x 1000 x 1740 mm62.99×39.37×68.50 in.
Weight	1740kg / 3836 lbs
Protection	OVP, OCP, OPP, OTP, FAN
Remote Interface	GPIO, RS-232, USB, Ethernet
Temperature Range	
Operating	0°C to 40°C
Storage	-40°C to 85°C
Humidity ^{*14}	0% to 95%
Safety & EMC	CE

- Note**
- *1: The accuracy of voltage, frequency and maximum distortion tests use Power Analyzer Line Filter=50kHz and Update rate=250ms to measure the linear load. The referenced instrument is Model: YOKOGAWA WT3000.
 - *2: The maximum distortion test is the maximum output power to linear load when the output voltage is set to 250VAC. In parallel mode the specification requires to increase 0.03xN% where N is the paralleled device number. Ex. The maximum distortion is (0.5+0.03x5)%=0.65% when 5 sets of model 61860 are paralleled under 50/60Hz.
 - *3: The load regulation condition is to set the sine wave output.
 - *4: Multiple devices parallel mode do not support single phase.
 - *5: In parallel mode the maximum current is N times of the standalone device's maximum current. Ex. The output current (RMS) of 5 paralleled 61860 is 100x5=500A and the output current peak is 1500A.
 - *6: The purpose of DC voltage output is to set the DC-bias for AC+DC.
 - *7: In parallel mode the DC output rating (every phase in 3-phase mode) is N times of the standalone device. Ex. The DC output current of 5 paralleled 61860 is 50x5=250A.
 - *8: The current harmonic distortion in Energy Recycling Mode is at 3Ø 400V_{LL}@50Hz input voltage.

- *9: If an extra breaker is required for wiring, the input specification 3Ø 200-220V±10%V_{LL} must use the breaker larger than 250A (the operating characteristics must be 8 times the rated current and the action time is 10ms), for the input specification 3Ø 380-400V±10% V_{LL} and 3Ø 440-480V±10%V_{LL}, the breaker larger than 150A should be used (the operating characteristics must be 15 times the rated current and the action time is 10ms). The referenced device models:
EW250EAG-3P200K,FUJI@380-400 V_{LL}/440-480 V_{LL},
EW250EAG-3P250K,FUJI@200-220 V_{LL}
- *10: In parallel mode the measurement specification such as current and power need to refer to * 5 multiplied by the number of paralleled.
- *11: The parallel mode not only measures the accuracy (RMS), the accuracy (Peak) needs to add the correction value of paralleled device, for instance when the accuracy (RMS) is 0.4%+0.3%F.S, the accuracy (Peak) must be >N Amp with output voltage and frequency set at 250VAC and 60Hz respectively to meet the specification. (N is the number of paralleled device.)
- *12: The current measurement display is 4 digits, for instance if the measured current is between 10.00A-99.99A, the minimum display digits are 00.01.
- *13: The test efficiency is the maximum output power to linear load when the output voltage sets to 250VAC.
- *15: See the voltage/current operating diagram below for the Regenerative Grid Simulator's output capability.
- *16: It tests the phase change mode accuracy at 200VAC input voltage and 100A loading current.
F.S.= 360 degree.
- *17: The optional HV only supports the slave model that has the same HV function when using in parallel mode. When in regenerative AC load mode, same power models are required for parallel mode, while two units of the same power are required when applying to series high voltage mode.

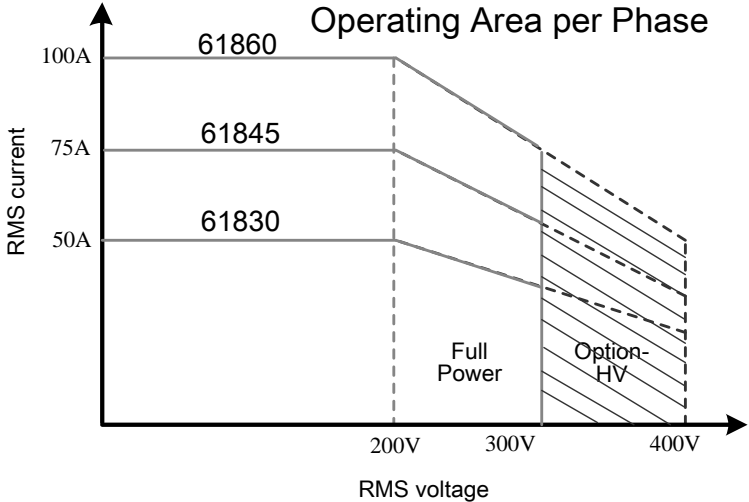

Voltage/Current Operating Range

1.4 Function Keys

1.4.1 Front Panel

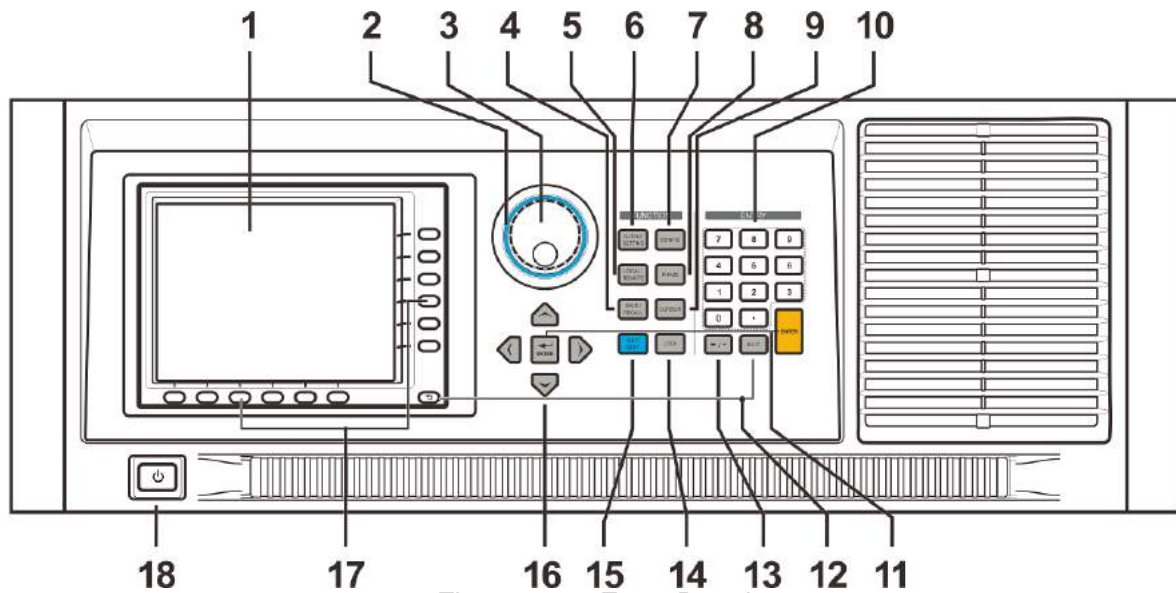









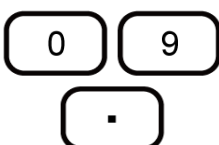

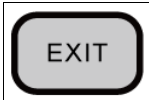
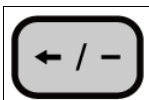

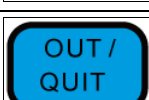
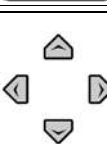

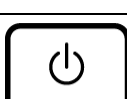

Figure 1-1 Front Panel

Table 1-1 Front Panel Description

Item	Symbol	Description
1		Display screen: 6.5 inch LCD to display the input/output settings and measured result.
2		Display LED: It surrounds the rotary knob and indicates the device is on when the light is on.
3		RPG rotary knob: It allows the user to turn the RPG rotary knob to adjust the voltage, frequency and input the programmed data or selection.
4		SAVE or RECALL key: Press this key on the MAIN PAGE can save/recall the output setting (see also 3.10.1) as well as the system data (see also 3.10.2.)
5		LOCAL/REMOTE key: It switches to the control mode to "LOCAL" or "REMOTE".
6		OUTPUT SETTING key: It skips to "Output: More Setting" for various functions settings.
7		CONFIG key: It skips to "CONFIG PAGE" for various functions settings.

8		PHASE key: It sets the phase to single or 3-phase.
9		CURSOR key: It shows the cursor to set or adjust the value.
10		Numeric and decimal keys: The numeric and decimal keys are for the user to input the digital data.
11		ENTER key: It confirms the setting of parameter.
12		EXIT key: It returns to the previous menu.
13		Backspace and decrease key: Press this key to erase the inputted number. Input minus "-", if there is no number before the cursor.
14		LOCK key: Press it for 1 second to lock all keys and the knob. Press it again for 3~4 seconds to unlock it.
15		OUT/QUIT key: Press this key can output the AC power or stop output voltage.
16		Cursor movement keys: These four movement keys move the cursor to different direction. In normal mode, press any of it will change the cursor position.
17		Indication key: It sets the parameter or function following the description on the screen.
18		Main power switch: It powers on or off the Regenerative Grid Simulator.

 **Notice**

To extend the usage of output relay, it will delay 50ms for release when **QUIT** is pressed. If the load connected is inductive load, it will provide a discharge route for inductor current during the delay time due to the characteristics of Inductor current freewheeling.

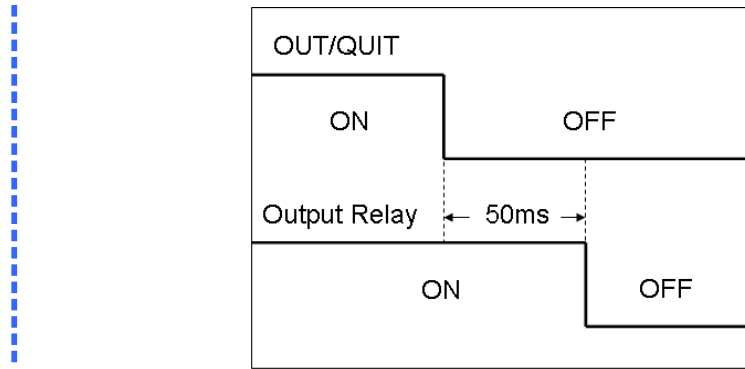

1.4.2 Rear Panel

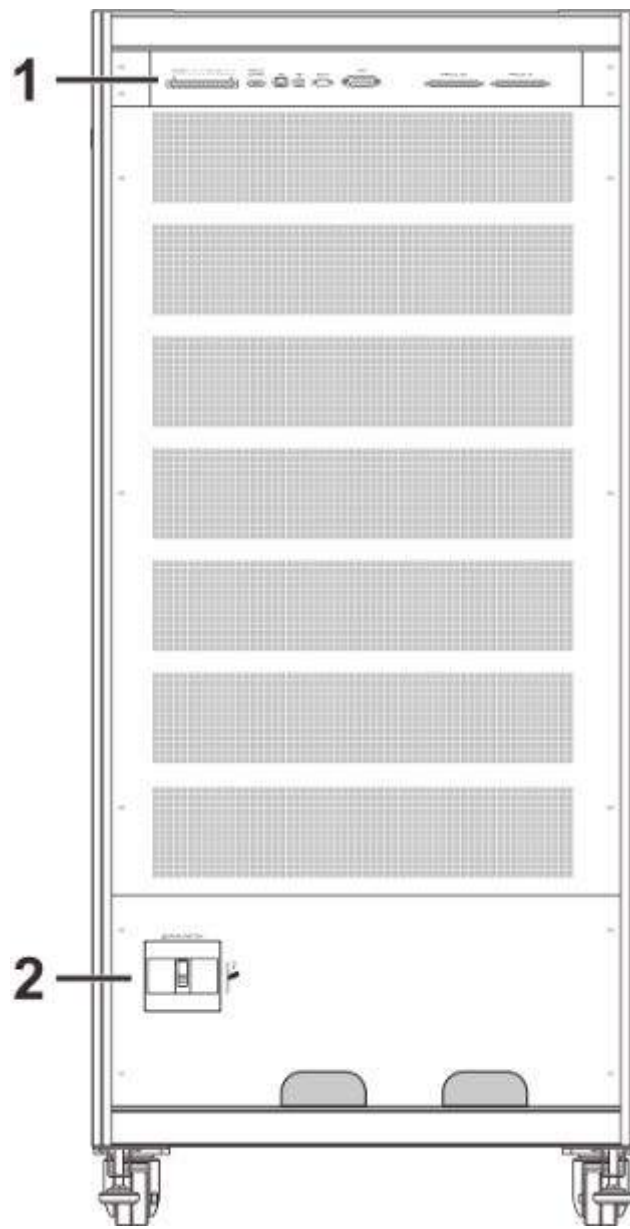

Type A

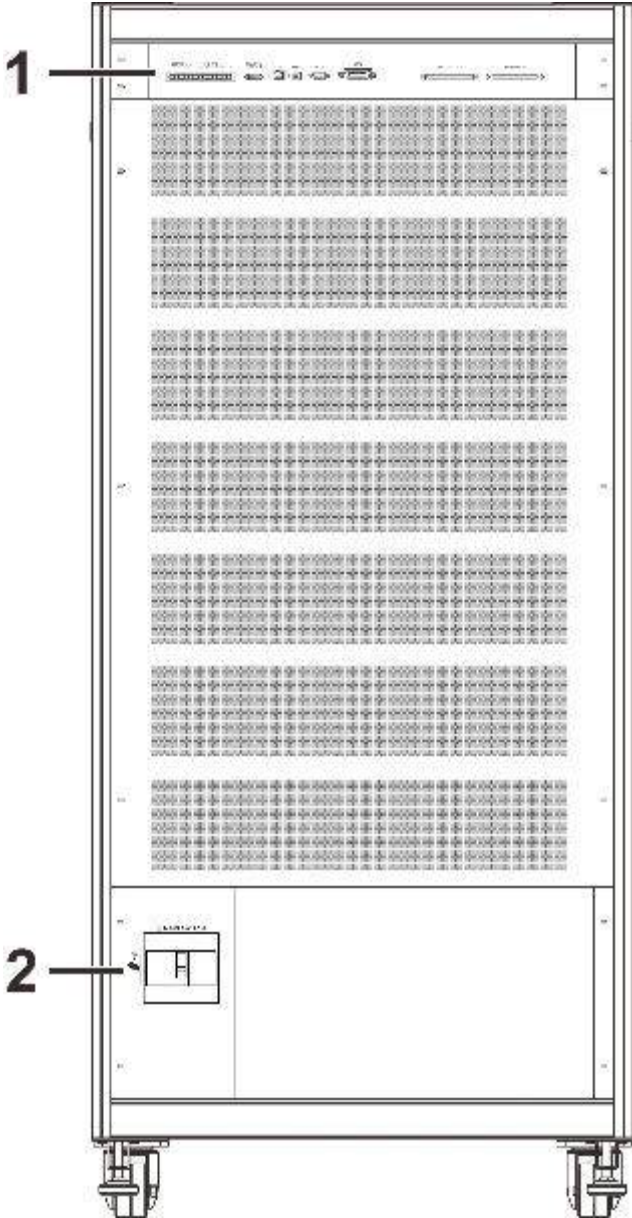

Type B

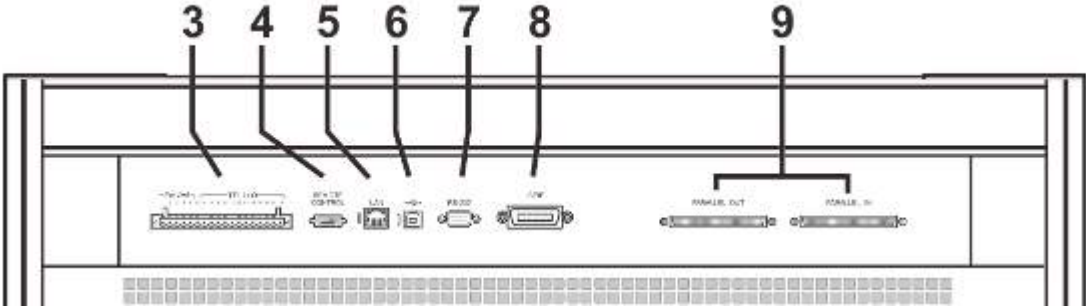

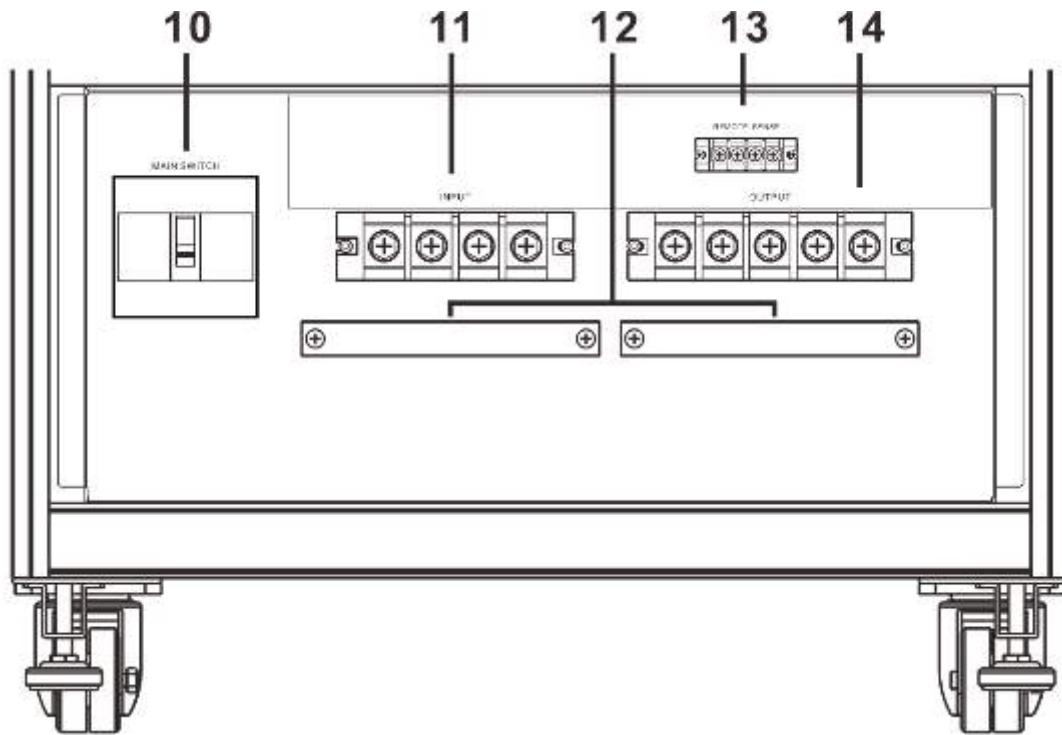

Type A

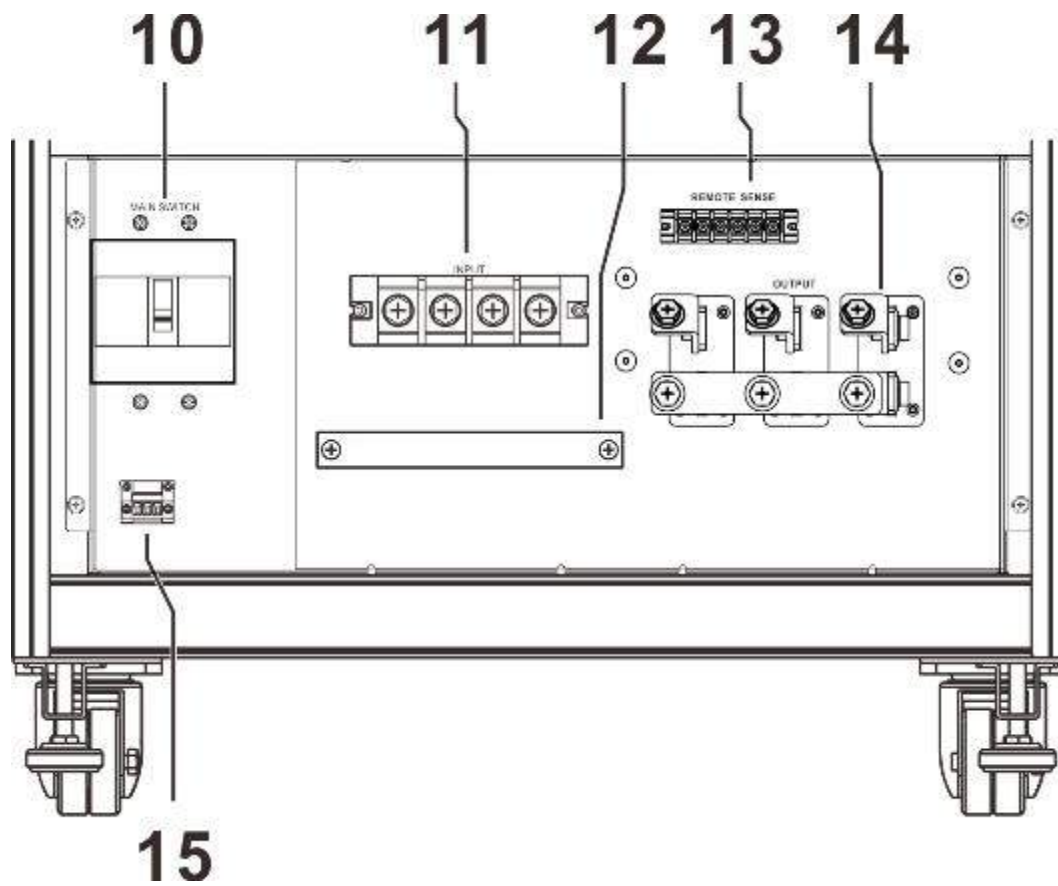

Type B

Figure 1-2 Rear Panel

Table 1-2 Rear Panel Description

Item	Symbol	Description
1	Rear Panel Control Interface	It contains Ext.Vref/TTL signal connector, remote control, GPIB, USB and RS-232 ports.
2	Input/Output Cable Connector (Safe casing)	Its internal has 3-phase power input and output terminal, the mains connector (3-phase) to the power input terminal, the power output connector to UUT and input no-fuse leakage breaker.
3	Ext. Vref./TTL I/O	The Ext.Vref port inputs analog signals to control the output waveform amplitude and the TTL I/O terminal to transmit the I/O control signal (Fault_out, Remote Inhibit & AC_ON.)
4	Remote Control	It is a remote control port that can control the Regenerative Grid Simulator via an optional device.
5	Ethernet	It is the network (LAN) control interface.
6	USB	It is the USB control interface that can connect to the PC for remote operation.
7	RS-232	It is a 9 pin D-type male connector for RS-232 interface that can connect to the PC for remote operation.
8	GPIB Connector	It is the GPIB interface that can connect to the PC for remote operation.
9	Parallel Signal Comm. Port	It is used to transmit the signal for Master/Slave parallel output.
10	Input No-Fuse Leakage Breaker	This breaker provides leakage current protection. When the leakage current is bigger than the set vale, the breaker will activate protection.
11	Power Input Terminal	This input terminal connects the mains 3-phase power.
12	Input/Output Cable Fixing Bar	It fixes the 3-phase input/output connecting cable.
13	Remote Sense	It is the remote voltage sense. It senses the load directly to compensate the voltage drop caused by the cable. Be sure that the "Ls" terminal of the remote sense connects to the "L" terminal of load while the "Ns" connects to the "N" terminal of load. (Do not use reverse polarity for connection.)
14	Power Output Terminal	It is a 3-phase output terminal that connects to the UUT.
15	Trip Switch Control Terminal	The switch control power is tripped to this terminal.

**Notice**

The type A and B of rear panels are both standard types where type B is applied to the models shipped after May 31, 2019.

2. Installation

2.1 Initial Inspection

Before shipment, this model was inspected and found to be free of mechanical and electrical defects. As soon as the device is unpacked, the user should inspect for any damage that may have occurred in transit. Save all packing materials in case the instrument has to be returned. If damage is found, please file a claim with the carrier immediately. Do not return the product to Chroma without prior approval.

2.2 Precautions before Use

1. First make sure that the floor is smooth and flat as well as durable for maximum weight before placing the simulator.
2. The simulator has to connect to proper AC line input.
3. The Regenerative Grid Simulator is a fan cooling instrument thus needs to be installed in a place with sufficient air flow.
4. The operating temperature cannot exceed 40°C.

2.3 Input Power Specification

2.3.1 Ratings

Input voltage range:

61830	61845	61860
125A Max./Phase (3Ø 200-220V±10%V _{LL})	190A Max./Phase (3Ø 200-220V±10%V _{LL})	250A Max./Phase (3Ø 200-220V±10%V _{LL})
68A Max./Phase (3Ø 380-400V±10%V _{LL})	100A Max./Phase (3Ø 380-400V±10%V _{LL})	130A Max./Phase (3Ø 380-400V±10%V _{LL})
60A Max./Phase (3Ø 440-480V±10%V _{LL})	87A Max./Phase (3Ø 440-480V±10%V _{LL})	115A Max./Phase (3Ø 440-480V±10%V _{LL})

- The 61800 Series products have 3 types of input voltage range; be sure to select the correct 3-phase AC voltage before purchase.
- All of the input voltage spec is based on 3-phase AC line voltage (L-L).

Input frequency: 47-63 Hz



It could cause the Regenerative Grid Simulator to be damaged if the input voltage is out of the spec.

2.3.2 Connecting for Input

The input connection plate is located at the bottom of the simulator. The power cable should be at least 85°C rated. The power cable input should have rated current larger or equal to the maximum rated current of Regenerative Grid Simulator.

Perform the steps below for connection as Figure 2-1 shows:

1. Remove the input cable connecting plate (safe casing) from the bottom of Regenerative Grid Simulator rear panel.
2. Connect the power cable to the power terminal of Regenerative Grid Simulator (see Figure 2-1.)
3. Slide the input cable connecting plate (safe casing) to cover the Regenerative Grid Simulator.
4. Secure the power cables using a fixing bar and lock with screw. ◦
5. Install the input cable connecting plate (safe casing) back.

⚡ CAUTION To protect the operator, the metal wire connected to GND terminal has to be earth grounded. In no cases the Regenerative Grid Simulator should not be operated without proper earth ground.

Voltage Range	Cable Spec.	Terminal Spec.
(3Ø 200-220V±10%V _{LL})	100mm ² (L1/L2/L3) 10mm ² (GND)	95-10(L1/L2/L3) 10-10(GND)
(3Ø 380-400V±10%V _{LL})	50mm ² (L1/L2/L3) 10mm ² (GND)	50-10(L1/L2/L3) 10-10(GND)
(3Ø 440-480V±10%V _{LL})	50mm ² (L1/L2/L3) 10mm ² (GND)	50-10(L1/L2/L3) 10-10(GND)

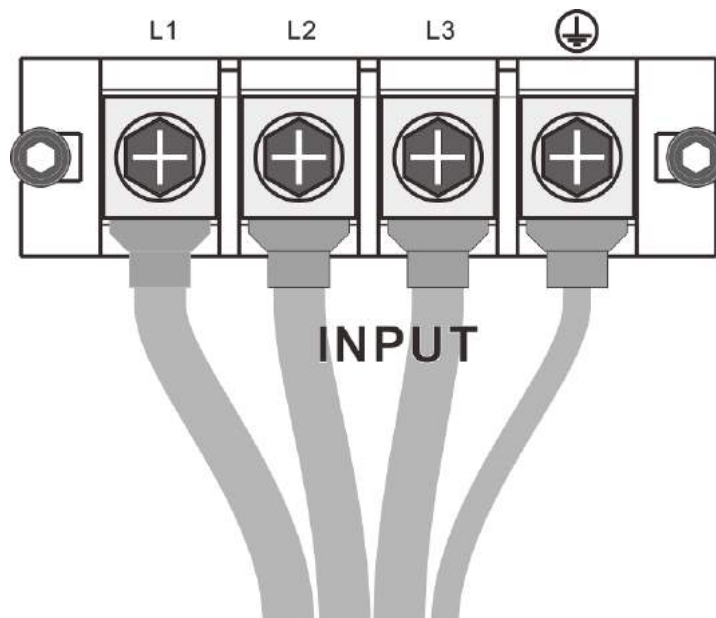

Figure 2-1 3-Phase Power Input Connection

🔧 Notice

1. The power cable installation has to be performed by professional personnel in compliance with the local electrician regulation.
2. All of the input voltage spec is based on 3-phase AC line voltage (L-L).

3. Before connecting the input power cable, be aware of the color on the insulation tube and power cable. The brown, black and gray tubes indicate the 3-phase power cable L1, L2 and L3 while the green with yellow inlaid tubes is for GROUND.

2.4 Output Connection

The output terminal socket is located at the rear side of Regenerative Grid Simulator. The load is connected to the output terminal. For safety reason, the AC input/output cable must be secured with a fixing bar and the casing has to be tightened up. The diameter the cable connected to the load has to be large enough so that it won't over heat when the output is over current, see Figure 2-2.

Notice

- When DC voltage is contained in the output voltage, the output terminal "L" is "+" and "COM/N" is "-".

WARNING

- For the simulator to dissipate heat smoothly, it is necessary to keep at least 1 meter space for the device front and rear panel for ventilation. Do not place the device against the wall or any other objects.

2.5 Connecting Remote Sense

The Remote Sense of the Regenerative Grid Simulator monitors the load voltage and compensates automatically to ensure the voltage transmitted to load is the set voltage.

Remove the cable connected to "L1", "L2", "L3" and "COM" from the Remote Sense terminal and change it by connecting to Load as Figure 2-2 shows. As the sense wire only sends a few MA (milliamps current), the sense metal wire is much thinner than the load wire. The sense wire is part of the Regenerative Grid Simulator feedback circuit, thus it has to keep low resistance in order to maintain the best performance. If the sense wire is not connected or opened during operation, the Regenerative Grid Simulator may not be able to output. It is necessary to ensure that the sense wire connection is not opened. The sense wire is twisted to reduce the interference from external voltage and needs to be close to the load as possible.

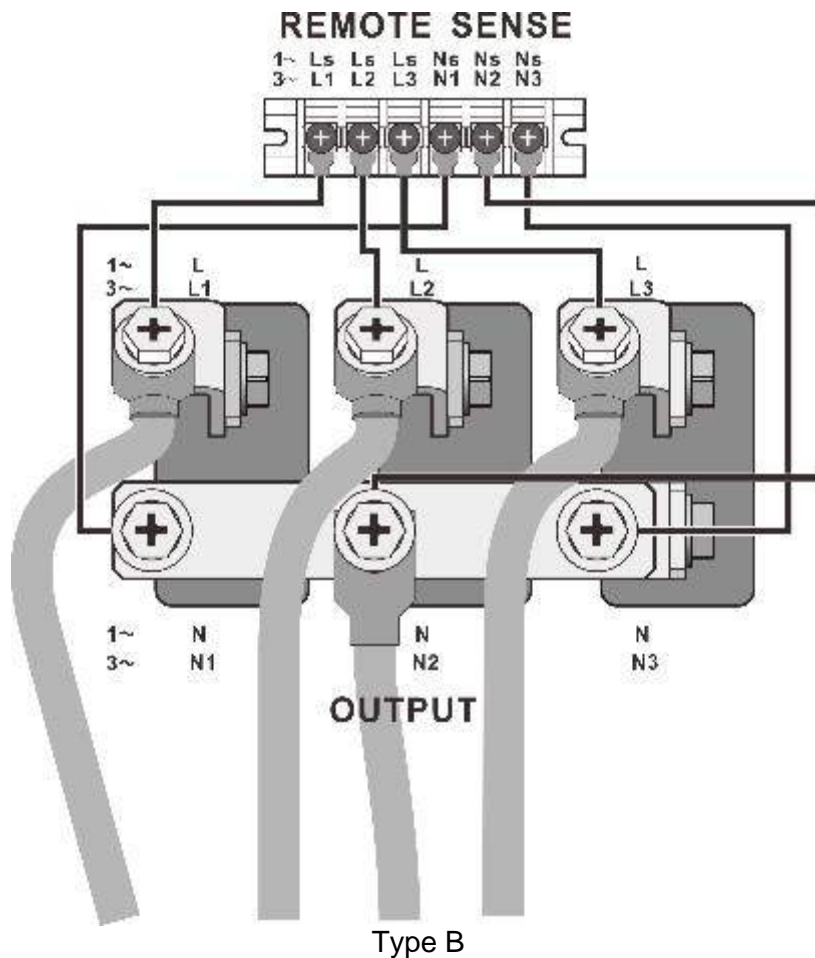
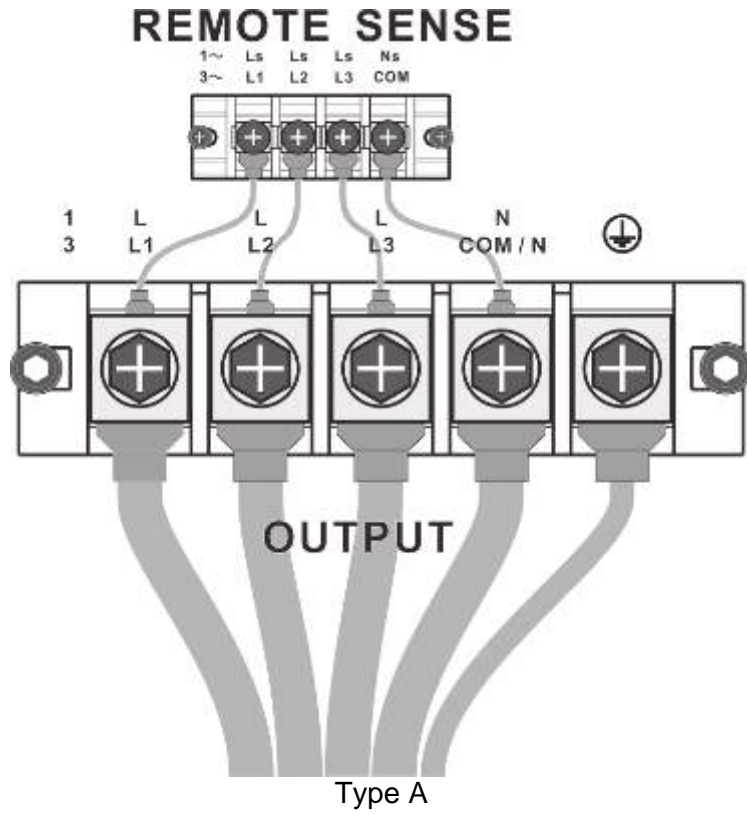
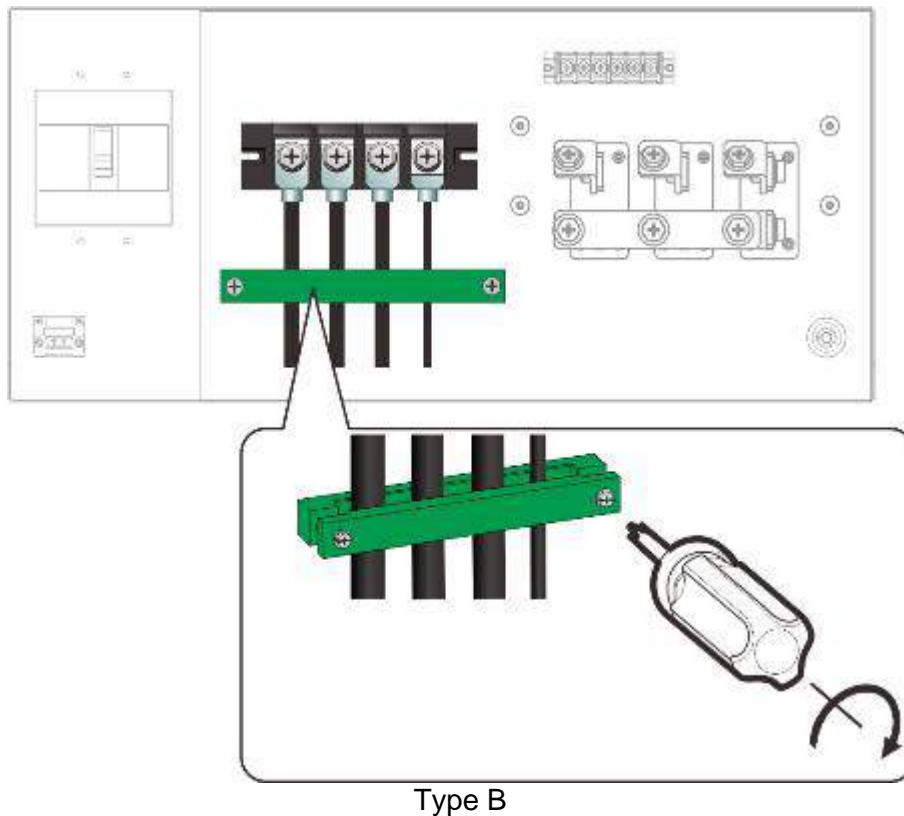
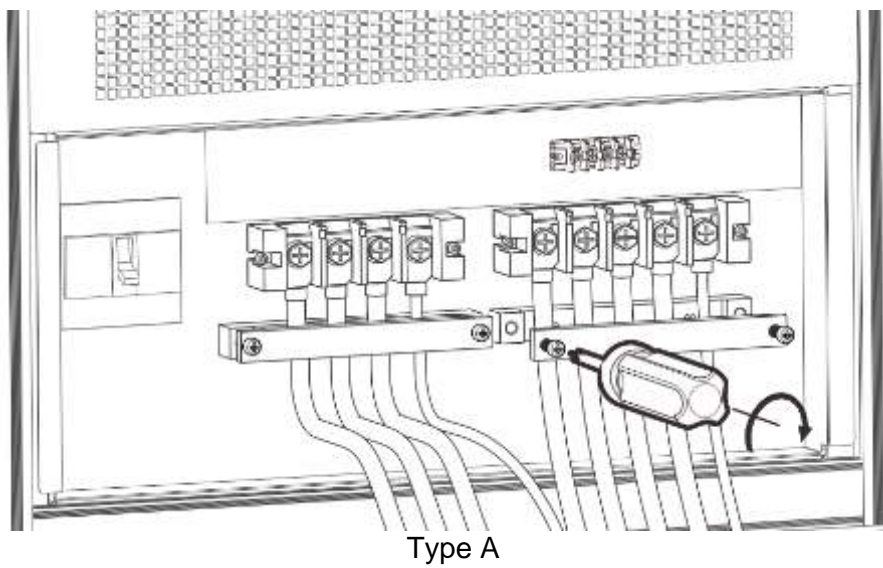

Figure 2-2 Connecting Output and Remote Voltage Sense



Type B
Figure 2-3 Securing Input/Output Wiring

Notice

1. When the output sets to single phase, the Remote Sense wire should connect to the output terminal of second phase.
2. The type A and B of rear panels are both standard types where type B is applied to the models shipped after May 31, 2019.

2.6 Power-On Procedure

⚡ CAUTION Before turning on the instrument, all protective earth terminals, extension cords and devices connected to the instrument must be connected to a protective earth ground. Any interruption of the protective earth ground may cause potential electric shock hazard and result in personal injury.

Connect the power line and turn on the power switch on the front panel. The Regenerative Grid Simulator will begin a series of self tests. The LCD on the front panel will be on and display as below.

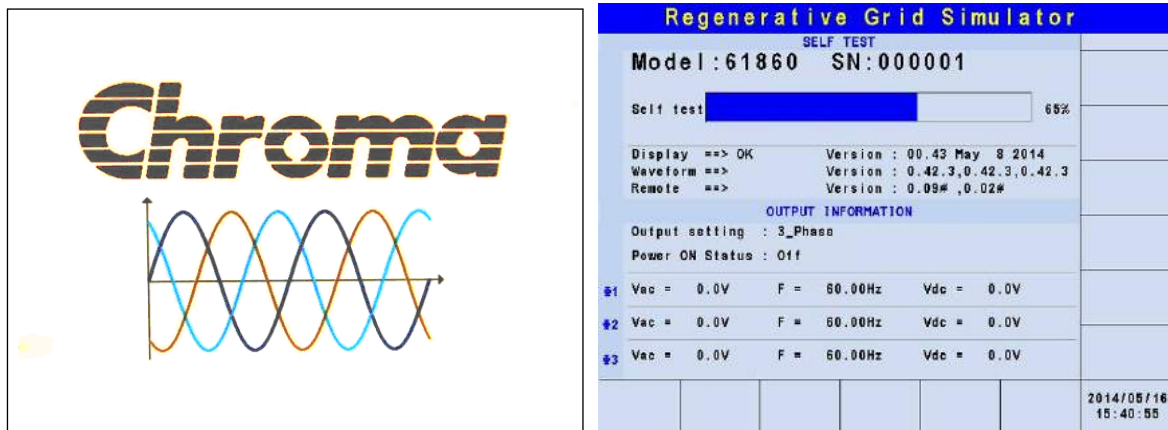

In the meantime the Regenerative Grid Simulator executes memory, data and communication self tests. The display shows the Model Number and Regenerative Grid Simulator's Serial No. after executing the self-test routines and each test item will show "OK" on the right if no error is found. It needs about 10 seconds for self-test to finish the routines and then the software version will show on the display.

"ERROR CODE" will appear on the right if one of the test items is failed.

When the self tests of memory, data and communication are done, the Regenerative Grid Simulator will conduct a power output self-test. The output relay is OFF during the procedure to ensure the load connected to the output terminal won't be damaged. The Regenerative Grid Simulator sets the output to 300Vac for voltage measurement. The power self-test fails and the display shows "NG" when the measured voltage is over 300V±100V. If the self-test is OK, the screen will change to the MAIN PAGE automatically.

- 📌 Notice**
1. The user can run self-diagnosis during power on self-test to see if there are any errors or NG (No Good) conditions.
 2. The Regenerative Grid Simulator needs about 20 seconds to finish the self-test.

2.7 Maintenance and Cleaning

Remove all connected wires and cables on the instrument before cleaning. Use a brush to clean the dust on it and if there are stains on the chassis that cannot be removed by brush, wipe it with a volatile liquid. Do not use any corrosive liquid to avoid damaging the chassis.

Use a damp cloth with soap and water or a soft detergent to clean the LCD front panel. Please send it back to the distributors or agents of Chroma for internal cleaning. Do not open the chassis cover arbitrarily

2.8 Common Environment Conditions

1. In door use only.
2. Altitude up to 2000m.
3. Temperature 0°C to 40°C.

3. Local Operation

3.1 Introduction





The Regenerative Grid Simulator can be configured to operate in local or remote mode. This section describes the operation in local mode using the keypad on the front panel for data entry and test. Local operation can be used directly when the Regenerative Grid Simulator is turned on.





3.2 Using Keyboard and RPG

The Regenerative Grid Simulator is equipped with a user friendly interface consisting of a keypad and a RPG (Rotary Pulse Generator) on the front panel. The LCD on Regenerative Grid Simulator displays the operations menu.

Figure 3-1 shows the command tree. The following describes how to use both the keypad and the RPG to set the commands. When the power-on procedure is completed (see 2.6), the display will show the MAIN PAGE (3_Phase Mode/1_Phase Mode) as below.

3 Phase LOCAL QUIT							1 Phase LOCAL QUIT						
OUTPUT SETTING						Main	OUTPUT SETTING						Main
#1	Vac =	0.0V	F =	60.00Hz		OUTPUT: More Setting	Vac = 0.0V F = 60.00Hz						OUTPUT: More Setting
#2	Vac =	0.0V	F =	60.00Hz		Measurement Setting							Measurement Setting
#3	Vac =	0.0V	F =	60.00Hz		Waveform Viewer	MEASUREMENT						Waveform Viewer
	V =	0.00	P ₀ =	0.0		Limitation	V =	0.00	P ₀ =	0.0		Limitation	
#1	I =	0.000	PF =	0.000		Output Mode	I =	0.000	PF =	0.000		Output Mode	
#2	V =	0.00	P ₀ =	0.0		Measurement To Page2	Vac =	0.00	Vdc =	0.00			
#3	I =	0.000	PF =	0.000			Iac =	0.000	Idc =	0.000			
	V ₁₂ =	0.00	V ₂₃ =	0.00			Vpk =	0.00	VA =	0.0			
Σ	V ₃₁ =	0.00	P ₀ =	0.0			Ipk =	0.000	CF =	0.000			
Recall CH1	Recall CH2	Recall CH3	Recall CH4	Recall CH5	More 1 of 2	2014/12/17 15:28:27	Recall CH1	Recall CH2	Recall CH3	Recall CH4	Recall CH5	More 1 of 2	2014/12/17 15:32:48

Press , , ,  keys to move the cursor for item selection. Use numeric and decimal keys or RPG to set values and press **ENTER** to confirm them. The user can press the keys located at the LCD bottom or lower right to set the parameters or functions following the description on the screen, or press  to return to the MAIN PAGE.

In the MAIN PAGE, it can press the keys located at the LCD bottom or lower right to select the function list. Use , , ,  to move the cursor after entering the function list. For digital setting, use the numeric and decimal keys or the RPG to set the value and then press **ENTER** for confirmation. For text setting, it can turn the RPG for selection and press **ENTER** for confirmation.

Main Page (Output & Meas. Setting) CONFIGURATION

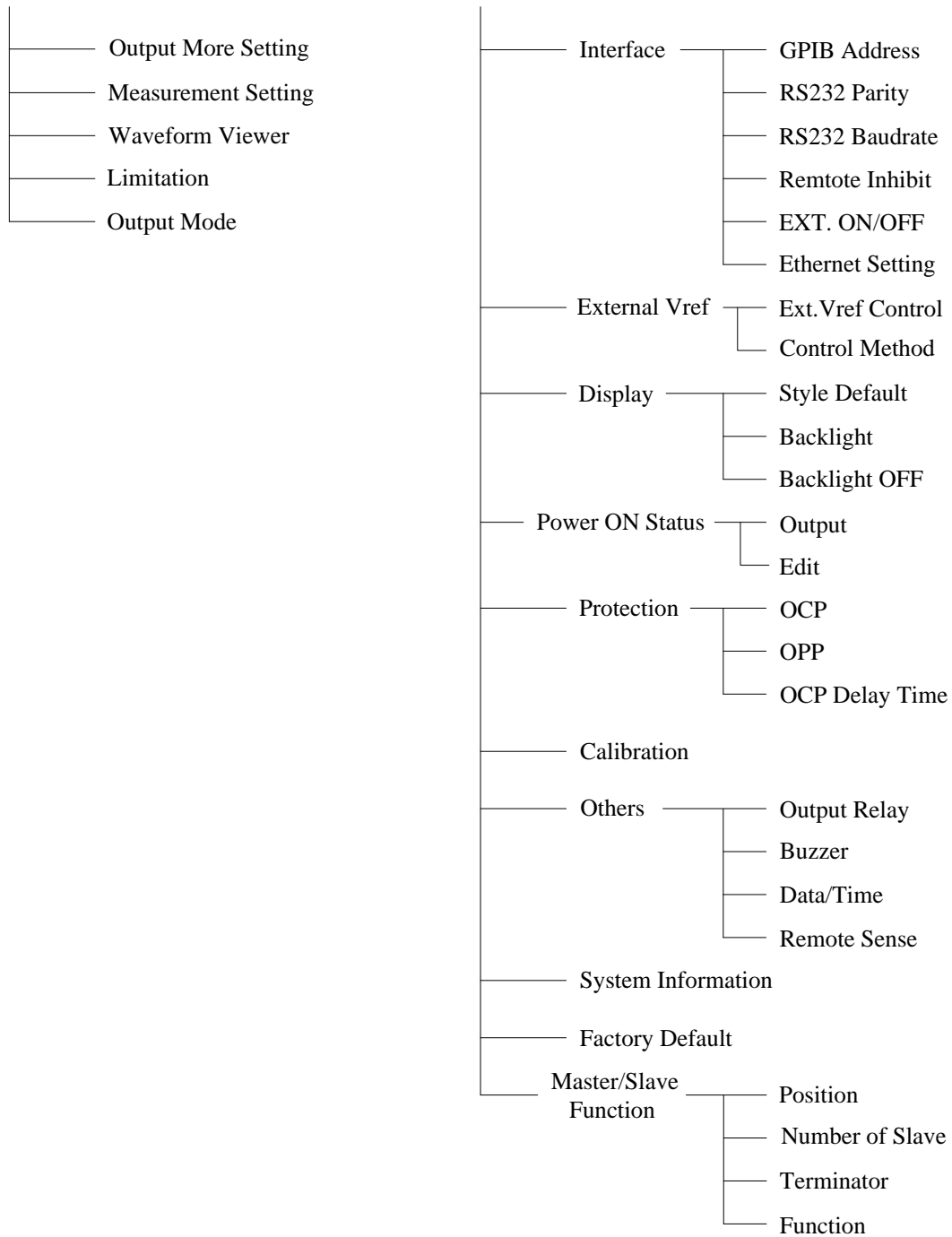
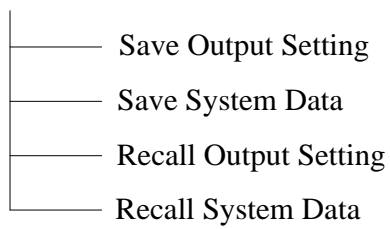

Figure 3-1

SAVE/RECALL



Output Setting

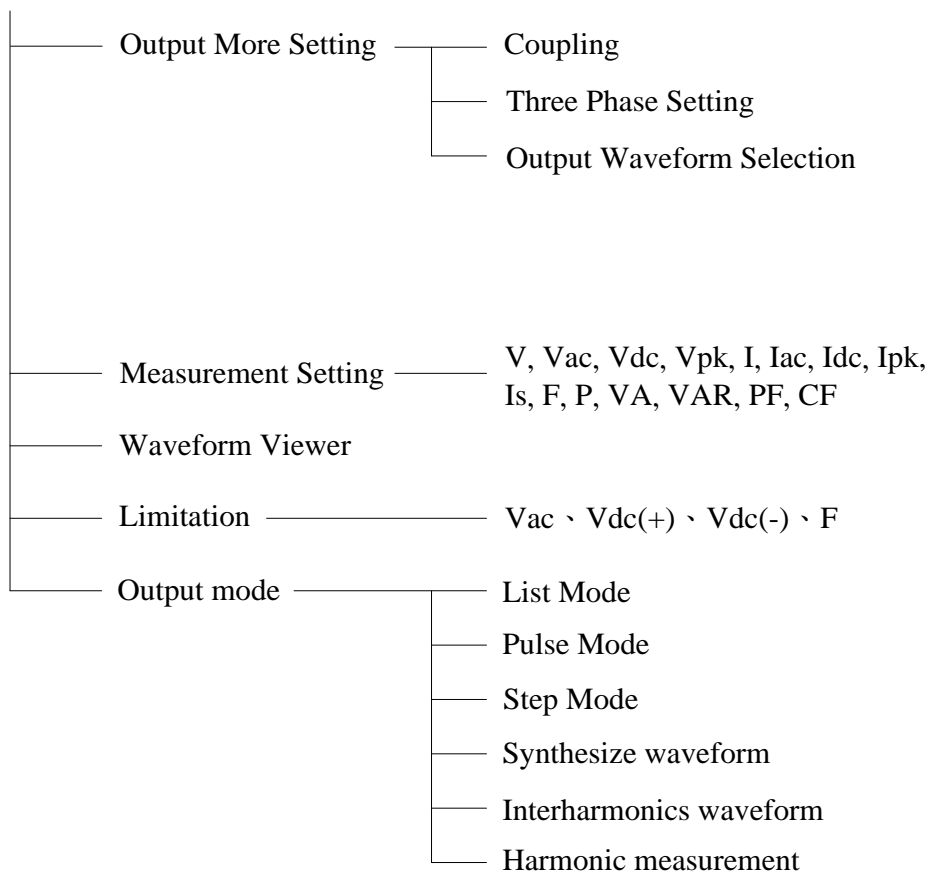

Figure 3-2

3.3 MAIN PAGE (for Output Setting and Measurement)

When the Regenerative Grid Simulator is turned on and finished the self-test, the screen displays the MAIN PAGE (3_Phase Mode/1_Phase Mode). The upper section on the screen shows the output setting. The default output setting can be set by the Power ON Status (see 3.4.4) under the CONFIG function key. The MEASUREMENT on the screen shows the items measured by the Regenerative Grid Simulator and each of them has 12 types totaling 3 pages as shown below.

3 Phase LOCAL QUIT							3 Phase LOCAL QUIT						
OUTPUT SETTING						Main	OUTPUT SETTING						Main
#1	Vac =	0.0V	F =	60.00Hz		OUTPUT: More Setting	#1	Vac =	0.0V	F =	60.00Hz		OUTPUT: More Setting
#2	Vac =	0.0V	F =	60.00Hz		Measurement Setting	#2	Vac =	0.0V	F =	60.00Hz		Measurement Setting
#3	Vac =	0.0V	F =	60.00Hz		Waveform Viewer	#3	Vac =	0.0V	F =	60.00Hz		Waveform Viewer
MEASUREMENT						Limitation	MEASUREMENT						Limitation
#1	V =	0.00	P ₀ =	0.0		Output Mode	#1	Vac =	0.00	Vdc =	0.00		Output Mode
	I =	0.000	PF =	0.000		Measurement To Page2		Iac =	0.000	Idc =	0.000		Measurement To Page3
#2	V =	0.00	P ₀ =	0.0		Recall CH1	#2	Vac =	0.00	Vdc =	0.00		Recall CH1
	I =	0.000	PF =	0.000		Recall CH2		Iac =	0.000	Idc =	0.000		Recall CH2
#3	V =	0.00	P ₀ =	0.0		Recall CH3	#3	Vac =	0.00	Vdc =	0.00		Recall CH3
	I =	0.000	PF =	0.000		Recall CH4		Iac =	0.000	Idc =	0.000		Recall CH4
Σ	V ₁₂ =	0.00	V ₂₃ =	0.00		Recall CH5	Σ	V ₁₂ =	0.00	V ₂₃ =	0.00		Recall CH5
	V ₃₁ =	0.00	P ₀ =	0.0		More 1 of 2		V ₃₁ =	0.00	VA =	0.0		More 1 of 2
						2014/12/17 15:28:27							2014/12/17 15:34:09

3 Phase LOCAL QUIT							1 Phase LOCAL QUIT						
OUTPUT SETTING						Main	OUTPUT SETTING						Main
#1	Vac =	0.0V	F =	60.00Hz		OUTPUT: More Setting	Vac = 0.0V F = 60.00Hz						OUTPUT: More Setting
#2	Vac =	0.0V	F =	60.00Hz		Measurement Setting							Measurement Setting
#3	Vac =	0.0V	F =	60.00Hz		Waveform Viewer							Waveform Viewer
MEASUREMENT						Limitation	MEASUREMENT						Limitation
#1	Vpk =	0.00	VA =	0.0		Output Mode	V =	0.00	P ₀ =	0.0		Output Mode	
	Ipk =	0.000	CF =	0.000		Measurement To Page1	I =	0.000	PF =	0.000		Measurement To Page1	
#2	Vpk =	0.00	VA =	0.0		Recall CH1	Vac =	0.00	Vdc =	0.00		Recall CH1	
	Ipk =	0.000	CF =	0.000		Recall CH2	Iac =	0.000	Idc =	0.000		Recall CH2	
#3	Vpk =	0.00	VA =	0.0		Recall CH3	Vpk =	0.00	VA =	0.0		Recall CH3	
	Ipk =	0.000	CF =	0.000		Recall CH4	Ipk =	0.000	CF =	0.000		Recall CH4	
Σ						Recall CH5	Σ					Recall CH5	
						More 1 of 2						More 1 of 2	
						2014/12/17 15:34:47						2014/12/17 15:32:48	

The definition of output parameters:

- Vac : AC output setting voltage in Volts
- F : Output frequency in Hertz.
- Vdc : DC output voltage in volts.

Press **OUT/QUIT** enables the Regenerative Grid Simulator's output with the set Vac, F and Vdc. Press it again the Regenerative Grid Simulator output is disabled

Notice

1. When Coupling = AC+DC, the output is the sum of Vac and Vdc. However, the combination of peak voltage cannot exceed 424.2V. The output voltage will skip to 0V automatically and trigger the protection (OVP) if it exceeds the voltage limit.
2. When switching to ACL mode (option), if the phase frequency of UUT voltage is having more than 1Hz error, the line voltage V₁₂, V₂₃ and V₃₁ measurement will not display.

Following lists the definition of measurement parameters:

- V : It is the voltage measurement in Volts. (True RMS measurement)
- F : It is the output frequency in Hertz.
- I : It is the current measurement in Amps. (True RMS measurement)
- P : It is the real power measurement in Volts.
- PF : It is Power Factor and the calculation formula = Real Power / (V_{rms} × I_{rms})
- CF : It is Crest Factor and the calculation formula = I_{peak}/I_{rms}
- Vdc : It is the DC voltage measurement in Volts.

- Idc : It is the DC current measurement in Amps.
- Ip : It is the peak current measurement in Amps. The Ipeak display is the Ip (+) or Ip (-) whichever is larger.
- Is : It is I surge that is only measured when output changes as defined in section 3.3.2.2.
- VA : It is the apparent power in Volt-Ampere and the calculation formula = $V_{rms} \times I_{rms}$.
- VAR : The calculation formula = $\sqrt{VA^2 - P^2}$

3.3.1 OUTPUT: More Setting

Press OUTPUT: More Setting in the MAIN PAGE (3_Phase Mode/1_Phase Mode) (see section 3.3); a line of output functions will appear at the bottom of the screen as described below.

3 Phase LOCAL QUIT						1 Phase LOCAL QUIT							
OUTPUT SETTING						OUTPUT SETTING							
#1	Vac =	0.0V	F =	60.00Hz	Setting	Vac = 0.0V F = 60.00Hz							
#2	Vac =	0.0V	F =	60.00Hz	OUTPUT: More Setting								
#3	Vac =	0.0V	F =	60.00Hz	Measurement Setting								
MORE SETTING						MORE SETTING							
#1	Waveform =	A				Waveform Viewer	Waveform = A						
		SINE					SINE						
#2	Waveform =	A				Limitation	ON Degree = 0.0						
		SINE					OFF Degree = IMMED						
#3	Waveform =	A				Output Mode	Vac S/R = 0.000V/ms						
		SINE					Vdc S/R = 0.000V/ms						
	ON Degree =	0.0	OFF Degree =	IMMED		F S/R = 0.000Hz/ms							
	Vac S/R =	0.000V/ms	Vdc S/R =	0.000V/ms		Phase angle 1-2 = 120.0							
	F S/R =	0.000Hz/ms					Phase angle 1-3 = 240.0						
Coupling	Three Phase Setting	Output Waveform Selection				2014/12/17 15:35:51	Coupling	AC	Output Waveform Selection				2014/12/17 15:35:30

3.3.1.1 Coupling Output Mode (AC+DC, AC, DC)

The Regenerative Grid Simulator has 3 types of output: AC+DC, AC and DC. The coupling can be set to meet a variety of applications.

The setting procedure from AC to AC+DC is described below:

1. Press Coupling at the bottom.
2. Turn the RPG to change the selection from AC to AC+DC and press **ENTER**.

3_Phase 300V LOCAL QUIT										
OUTPUT SETTING								Setting		
#1	Vac =	0.0V	F =	60.00Hz						Setting
#2	Vac =	0.0V	F =	60.00Hz						OUTPUT: More Setting
#3	Vac =	0.0V	F =	60.00Hz						Measurement Setting
MORE SETTING										
#1	Waveform =	A								Waveform Viewer
		SINE								
#2	Waveform =	A								Waveform Viewer
		SINE								
#3	Waveform =	A								Limitation
		SINE								
	ON Degree =	0.0			OFF Degree =	0.0				Output Mode
	Vac S/R =	0.000V/ms			Vdc S/R =	0.000V/ms				
	F S/R =	0.000Hz/ms								
	Phase angle 1-2 =	120.0			Phase angle 1-3 =	240.0				
Coupling	Range	Three	Output							2014/08/23 13:34:58
AC	300V	Phase	Waveform							
		Setting	Selection							

3_Phase 300V LOCAL QUIT										
OUTPUT SETTING								Setting		
#1	Vac =	0.0V	F =	60.00Hz	Vdc =	0.0V				Setting
#2	Vac =	0.0V	F =	60.00Hz	Vdc =	0.0V				OUTPUT: More Setting
#3	Vac =	0.0V	F =	60.00Hz	Vdc =	0.0V				Measurement Setting
MORE SETTING										
#1	Waveform =	A								Waveform Viewer
		SINE								
#2	Waveform =	A								Waveform Viewer
		SINE								
#3	Waveform =	A								Limitation
		SINE								
	ON Degree =	0.0			OFF Degree =	0.0				Output Mode
	Vac S/R =	0.000V/ms			Vdc S/R =	0.000V/ms				
	F S/R =	0.000Hz/ms								
	Phase angle 1-2 =	120.0			Phase angle 1-3 =	240.0				
Coupling	Range	Three	Output							2014/08/23 13:35:21
AC+DC	300V	Phase	Waveform							
		Setting	Selection							

3_Phase 300V LOCAL QUIT										
OUTPUT SETTING								Setting		
#1	Vac =	0.0V	F =	60.00Hz	Vdc =	0.0V				Setting
#2	Vac =	0.0V	F =	60.00Hz	Vdc =	0.0V				OUTPUT: More Setting
#3	Vac =	0.0V	F =	60.00Hz	Vdc =	0.0V				Measurement Setting
MORE SETTING										
#1	Waveform =	A								Waveform Viewer
		SINE								
#2	Waveform =	A								Waveform Viewer
		SINE								
#3	Waveform =	A								Limitation
		SINE								
	ON Degree =	0.0			OFF Degree =	0.0				Output Mode
	Vac S/R =	0.000V/ms			Vdc S/R =	0.000V/ms				
	F S/R =	0.000Hz/ms								
	Phase angle 1-2 =	120.0			Phase angle 1-3 =	240.0				
Coupling	Range	Three	Output							2014/08/23 13:35:48
AC+DC	300V	Phase	Waveform							
		Setting	Selection							

Notice

Since the Regenerative Grid Simulator does not have as many capacitors as the common DC Power Supply, some voltage fluctuations and transient load characters are not the same. This Regenerative Grid Simulator is able to provide positive and negative voltage without changing the output connector. When the capacitor charging current is too high, it may raise output volatility concerns.

Though the Regenerative Grid Simulator has AC/DC/AC+DC output mode, the features are still different from the common DC Power Supply when in pure DC mode as explained below.

1. The output voltage ripple is bigger because there is no output capacitor.
2. When the output current reaches the current limit set point, the output voltage will be cut off and in protection mode. It will not stay in constant current mode with a voltage drop like common DC sources.

3.3.1.2 Setting Three Phase Output

Press Three Phase Setting to enter into the function as shown below.

Edit: All, Each

Press Edit to set “Each” or “All” for 3-phase output voltage limit.

3_Phase		LOCAL	QUIT	
OUTPUT SETTING				Setting
#1	Vac = 0.0V	F = 60.00Hz		Edit Each
#2	Vac = 0.0V	F = 60.00Hz		
#3	Vac = 0.0V	F = 60.00Hz		Sequence Positive
MORE SETTING				
#1	Waveform = A SINE			Three Phases Independent.
#2	Waveform = A SINE			
#3	Waveform = A SINE			
ON Degree = 0.0		OFF Degree = IMMED		Phase re-lock Disable
Vac S/R = 0.000V/ms		Vdc S/R = 0.000V/ms		
F S/R = 0.000Hz/ms				
Phase angle 1-2 = 120.0		Phase angle 1-3 = 240.0		
Coupling AC	Three Phase Setting	Output Waveform Selection		2014/12/17 15:42:41

Sequence: Positive, Negative

For example, the phase difference degree of 3-phase in positive balance is 120 degrees as shown below.

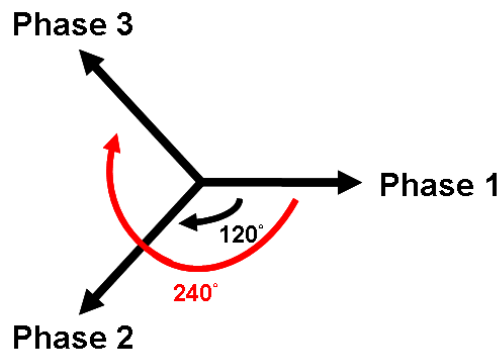

Press Sequence to set the Positive/Negative sequence for Regenerative Grid Simulator's 3-phase voltage output. The following lists the procedure to set the 3-phase output voltage sequence to Negative.

1. Press Sequence on the right.
2. Use RPG to select "Negative" and press **ENTER**.

3_Phase		LOCAL	QUIT	
OUTPUT SETTING				Setting
#1	Vac = 0.0V	F = 60.00Hz		Edit Each
#2	Vac = 0.0V	F = 60.00Hz		
#3	Vac = 0.0V	F = 60.00Hz		Sequence Positive
MORE SETTING				
#1	Waveform = A SINE			Three Phases Independent.
#2	Waveform = A SINE			
#3	Waveform = A SINE			
ON Degree = 0.0		OFF Degree = IMMED		Phase re-lock Disable
Vac S/R = 0.000V/ms		Vdc S/R = 0.000V/ms		
F S/R = 0.000Hz/ms				
Phase angle 1-2 = 120.0		Phase angle 1-3 = 240.0		
Coupling AC	Three Phase Setting	Output Waveform Selection		2014/12/17 15:43:32

3_Phase		LOCAL	QUIT	
OUTPUT SETTING				Setting
#1	Vac = 0.0V	F = 60.00Hz		Edit Each
#2	Vac = 0.0V	F = 60.00Hz		
#3	Vac = 0.0V	F = 60.00Hz		Sequence Negative
MORE SETTING				
#1	Waveform = A SINE			Three Phases Independent.
#2	Waveform = A SINE			
#3	Waveform = A SINE			
ON Degree = 0.0		OFF Degree = IMMED		Phase re-lock Disable
Vac S/R = 0.000V/ms		Vdc S/R = 0.000V/ms		
F S/R = 0.000Hz/ms				
Phase angle 1-2 = 120.0		Phase angle 1-3 = 240.0		
Coupling AC	Three Phase Setting	Output Waveform Selection		2014/12/17 15:44:12

3_Phase		LOCAL	QUIT		
OUTPUT SETTING					
#1	Vac =	0.0V	F =	60.00Hz	Setting
#2	Vac =	0.0V	F =	60.00Hz	Edit Each
#3	Vac =	0.0V	F =	60.00Hz	Sequence Positive
MORE SETTING					
#1	Waveform =	A			
		SINE			
#2	Waveform =	A			
		SINE			
#3	Waveform =	A			
		SINE			
ON Degree =		0.0	OFF Degree =		IMMED
Vac S/R =		0.000V/ms	Vdc S/R =		0.000V/ms
F S/R =		0.000Hz/ms			
Phase angle 1-2 =		120.0	Phase angle 1-3 =		240.0
Coupling	Three Phase Setting	Output Waveform Selection			2014/12/17 15:44:50

Three Phases: Independ., Same Freq, Balance

Press Three Phases to set the relationship among the Regenerative Grid Simulator 3-phase output voltage, which are Independ., Same Freq and Balance.

Following lists the procedure to set the same frequency for 3-phase voltage output.

1. Press Three Phases on the right.
2. Use RPG to select "Same freq" and press **ENTER**.

3 Phase		LOCAL	QUIT		
OUTPUT SETTING					
#1	Vac =	0.0V	F =	60.00Hz	Setting
#2	Vac =	0.0V	F =	60.00Hz	Edit Each
#3	Vac =	0.0V	F =	60.00Hz	Sequence Positive
MORE SETTING					
#1	Waveform =	A			
		SINE			
#2	Waveform =	A			
		SINE			
#3	Waveform =	A			
		SINE			
ON Degree =		0.0	OFF Degree =		IMMED
Vac S/R =		0.000V/ms	Vdc S/R =		0.000V/ms
F S/R =		0.000Hz/ms			
Phase angle 1-2 =		120.0	Phase angle 1-3 =		240.0
Coupling	Three Phase Setting	Output Waveform Selection			2014/12/17 15:44:50

3 Phase		LOCAL	QUIT		
OUTPUT SETTING					
#1	Vac =	0.0V	F =	60.00Hz	Setting
#2	Vac =	0.0V	F =	60.00Hz	Edit Each
#3	Vac =	0.0V	F =	60.00Hz	Sequence Positive
MORE SETTING					
#1	Waveform =	A			
		SINE			
#2	Waveform =	A			
		SINE			
#3	Waveform =	A			
		SINE			
ON Degree =		0.0	OFF Degree =		IMMED
Vac S/R =		0.000V/ms	Vdc S/R =		0.000V/ms
F S/R =		0.000Hz/ms			
Phase angle 1-2 =		120.0	Phase angle 1-3 =		240.0
Coupling	Three Phase Setting	Output Waveform Selection			2014/12/17 15:46:35

3_Phase		LOCAL	QUIT		
OUTPUT SETTING					
#1	Vac =	0.0V	F =	60.00Hz	Setting
#2	Vac =	0.0V			
#3	Vac =	0.0V			
MORE SETTING					
#1	Waveform =	A			
		SINE			
#2	Waveform =	A			
		SINE			
#3	Waveform =	A			
		SINE			
ON Degree =		0.0	OFF Degree =		IMMED
Vac S/R =		0.000V/ms	Vdc S/R =		0.000V/ms
F S/R =		0.000Hz/ms			
Phase angle 1-2 =		120.0	Phase angle 1-3 =		240.0
Coupling	Three Phase Setting	Output Waveform Selection			2014/12/17 15:51:02

When 3-phase balance is in use, the user may set the output voltage to be Phase Volt or Line Volt. Below is the procedure for setting the 3-phase voltage output to 3-phase balance.

1. Press Three Phases on the right.
2. Use RPG to select “Balance” and press **ENTER**.
3. Press Voltage set on the right.
4. Use RPG to select “Line” and press **ENTER**.

3 Phase			LOCAL			QUIT			
OUTPUT SETTING									
#1	Vac =	0.0V	F =	60.00Hz	Setting				
#2	Vac =	0.0V				Edit Each			
#3	Vac =	0.0V				Sequence Negative			
MORE SETTING									
#1	Waveform =	A				Three Phases			
		SINE				Balance			
#2	Waveform =	A							
		SINE							
#3	Waveform =	A							
		SINE							
ON Degree =		0.0	OFF Degree =		IMMED				
Vac S/R =		0.000V/ms	Vdc S/R =		0.000V/ms				
F S/R =		0.000Hz/ms							
Phase angle 1-2 =			120.0	Phase angle 1-3 =		240.0			
Coupling	Three	Output						2014/12/17	
AC	Phase	Waveform						15:51:58	
	Setting	Selection							

3 Phase			LOCAL			QUIT			
OUTPUT SETTING									
Balanced, Sequence:Negative, Voltage:Phase									
#1	Vac =	0.0V	F =	60.00Hz	Setting				
#2	Vac =	0.0V				Edit Each			
#3	Vac =	0.0V				Sequence Negative			
MORE SETTING									
#1	Waveform =	A				Three Phases			
		SINE				Balance			
#2	Waveform =	A				Voltage set			
		SINE				Phase			
#3	Waveform =	A							
		SINE							
ON Degree =		0.0	OFF Degree =		IMMED				
Vac S/R =		0.000V/ms	Vdc S/R =		0.000V/ms				
F S/R =		0.000Hz/ms							
Coupling	Three	Output						2014/12/17	
AC	Phase	Waveform						15:53:02	
	Setting	Selection							

3 Phase			LOCAL			QUIT			
OUTPUT SETTING									
Balanced, Sequence:Negative, Voltage:Phase									
#1	Vac =	0.0V	F =	60.00Hz	Setting				
#2	Vac =	0.0V				Edit Each			
#3	Vac =	0.0V				Sequence Negative			
MORE SETTING									
#1	Waveform =	A				Three Phases			
		SINE				Balance			
#2	Waveform =	A				Voltage set			
		SINE				Line			
#3	Waveform =	A							
		SINE							
ON Degree =		0.0	OFF Degree =		IMMED				
Vac S/R =		0.000V/ms	Vdc S/R =		0.000V/ms				
F S/R =		0.000Hz/ms							
Coupling	Three	Output						2014/12/17	
AC	Phase	Waveform						15:53:46	
	Setting	Selection							

3 Phase			LOCAL			QUIT			
OUTPUT SETTING									
Balanced, Sequence:Negative, Voltage:Line									
#1	Vac =	0.0V	F =	60.00Hz	Setting				
#2	Vac =	0.0V				Edit Each			
#3	Vac =	0.0V				Sequence Negative			
MORE SETTING									
#1	Waveform =	A				Three Phases			
		SINE				Balance			
#2	Waveform =	A				Voltage set			
		SINE				Line			
#3	Waveform =	A							
		SINE							
ON Degree =		0.0	OFF Degree =		IMMED				
Vac S/R =		0.000V/ms	Vdc S/R =		0.000V/ms				
F S/R =		0.000Hz/ms							
Coupling	Three	Output						2014/12/17	
AC	Phase	Waveform						15:54:22	
	Setting	Selection							

Phase re-lock: Enable, Disable

Phase re-lock is used to lock the phase again. Since the output voltage and frequency are set separately when the Regenerative Grid Simulator is in 3-phase mode, users can set the 3-phase for different frequency output. Assuming the 3-phase output frequencies are varied and users set them to the same when the phase re-lock function is disabled, the phase difference of the 3-phase output does not return to default (each phase difference is 120°) as Figure 3-3 shows. The phase difference of 3-phase output will return to default (each phase difference is 120°) as Figure 3-4 shows when the phase re-lock function is enabled.

Press Phase re-lock on the right to enable or disable the function.

3 Phase LOCAL QUIT		3 Phase LOCAL QUIT	
OUTPUT SETTING		OUTPUT SETTING	
#1 Vac = 0.0V	F = 60.00Hz	#1 Vac = 0.0V	F = 60.00Hz
#2 Vac = 0.0V	F = 60.00Hz	#2 Vac = 0.0V	F = 60.00Hz
#3 Vac = 0.0V	F = 60.00Hz	#3 Vac = 0.0V	F = 60.00Hz
MORE SETTING		MORE SETTING	
#1 Waveform = A	SINE	#1 Waveform = A	SINE
#2 Waveform = A	SINE	#2 Waveform = A	SINE
#3 Waveform = A	SINE	#3 Waveform = A	SINE
ON Degree = 0.0	OFF Degree = IMMED	ON Degree = 0.0	OFF Degree = IMMED
Vac S/R = 0.000V/ms	Vdc S/R = 0.000V/ms	Vac S/R = 0.000V/ms	Vdc S/R = 0.000V/ms
F S/R = 0.000Hz/ms		F S/R = 0.000Hz/ms	
Phase angle 1-2 = 120.0	Phase angle 1-3 = 240.0	Phase angle 1-2 = 120.0	Phase angle 1-3 = 240.0
Coupling AC	Three Phase Setting	Coupling AC	Three Phase Setting
	Output Waveform Selection		Output Waveform Selection
	2014/12/17 15:55:23		2014/12/17 15:56:12

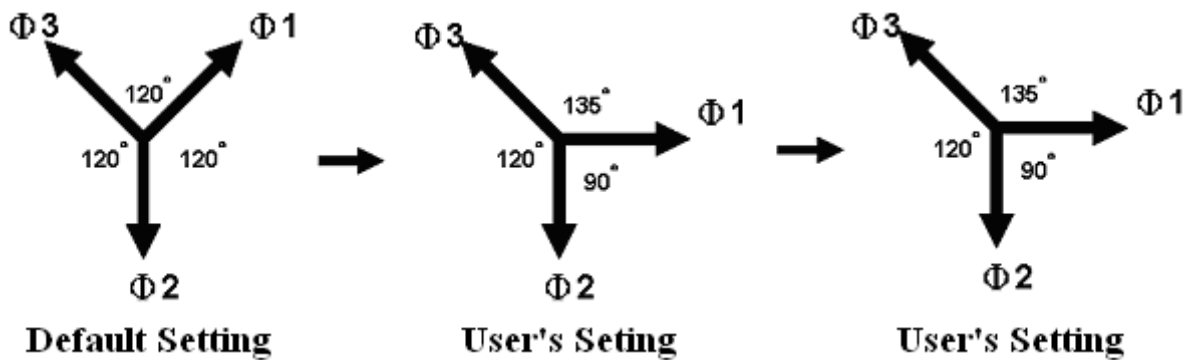

Figure 3-3 Phase Re-lock Disabled

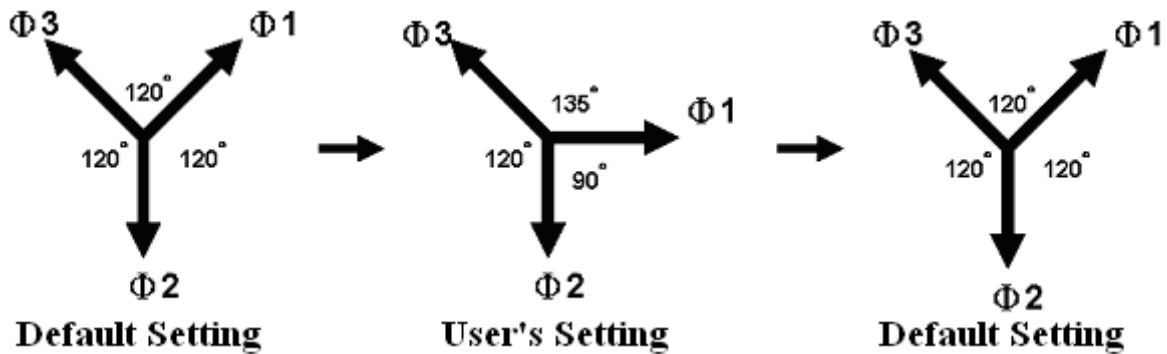

Figure 3-4 Phase Re-lock Enabled

3.3.1.3 Output Degree

The Regenerative Grid Simulator can control the degree of the waveform during output or when stopping the output. In the MAIN PAGE (3_Phase Mode/1_Phase Mode) (see 3.3) press OUTPUT: More Setting on the right to set ON Degree and OFF Degree.

Following is the procedure to set the output phase degree to ON Degree = 90 and OFF Degree=180 in 1_Phase Mode /3_Phase Mode.

1. Press OUTPUT: More Setting on the right.
2. Move the cursor to "ON Degree=" command position.
3. Press **9**, **0**, and **ENTER** to change the value to "90.0".
4. The cursor moves to "OFF Degree=" command position automatically.
5. Press **1**, **8**, **0**, and **ENTER** to change the value to "180.0".

1_Phase 300V LOCAL QUIT					1_Phase LOCAL QUIT				
OUTPUT SETTING					OUTPUT SETTING				
Vac = 0.0V F = 60.00Hz					Vac = 0.0V F = 60.00Hz				
MORE SETTING					MORE SETTING				
Waveform = A SINE					Waveform = A SINE				
ON Degree = 90.0					ON Degree = 90.0				
OFF Degree = 180.0					OFF Degree = 180.0				
Vac S/R = 0.000V/ms					Vac S/R = 0.000V/ms				
Vdc S/R = 0.000V/ms					Vdc S/R = 0.000V/ms				
F S/R = 0.000Hz/ms					F S/R = 0.000Hz/ms				
Coupling	Range	Output	Waveform	Selection	Coupling	Range	Output	Waveform	Selection
AC	300V				AC				
2014/08/23 13:46:38					2014/12/17 15:58:11				

Notice

If "OFF Degree=IMMED" when **QUIT** is pressed, the output voltage jumps off immediately. If a degree is already set, it will output voltage till it reaches the set degree. Input "OFF Degree= 360" will turn into "OFF Degree= IMMED".

3.3.1.4 Slew Rate of Output Transient

The Regenerative Grid Simulator has the ability to set the slew rates of the voltage waveform. This is done through 3 commands in OUTPUT: More Setting. They are Vac S/R, F S/R and Vdc S/R, which control the change speed of voltage waveform.

Vac S/R: It is the slew rate of Vac output.
 F S/R: It is the slew rate of frequency output.
 Vdc S/R: It is the slew rate of Vdc output.

Change the output setting in MAIN PAGE when the Regenerative Grid Simulator is in OUT mode, the output voltage and frequency will change to follow the setting of Vac S/R, F S/R and Vdc S/R.

The procedure of setting Vac S/R =0.2, F S/R =0.1 and Vdc S/R =1 1_Phase Mode /3_Phase Mode is described below.

1. Move the cursor to "Vac S/R =" command line.
2. Press **0**, **.**, **2** and **ENTER** to change the value to "0.2".
3. The cursor moves to "F S/R =" command automatically, press **0**, **.**, **1** and **ENTER**.
4. The cursor moves to "Vdc S/R =" command automatically, press **1** and **ENTER**.

3 Phase LOCAL QUIT						1 Phase LOCAL QUIT					
OUTPUT SETTING						OUTPUT SETTING					
#1	Vac =	0.0V	F =	60.00Hz	Setting	Vac =	0.0V	F =	60.00Hz	Setting	
#2	Vac =	0.0V	F =	60.00Hz	OUTPUT: More Setting					OUTPUT: More Setting	
#3	Vac =	0.0V	F =	60.00Hz	Measurement Setting					Measurement Setting	
MORE SETTING						MORE SETTING					
#1	Waveform =	A			Waveform Viewer	Waveform =	A			Waveform Viewer	
		SINE					SINE				
#2	Waveform =	A									
		SINE									
#3	Waveform =	A			Limitation					Limitation	
		SINE									
ON Degree =	0.0	OFF Degree =	IMMED		Output Mode	ON Degree =	0.0	OFF Degree =	IMMED	Output Mode	
Vac S/R =	0.200V/ms	Vdc S/R =	1.000V/ms			Vac S/R =	0.200V/ms	Vdc S/R =	1.000V/ms		
F S/R =	0.100Hz/ms					F S/R =	0.100Hz/ms				
Phase angle 1-2 =	120.0	Phase angle 1-3 =	240.0								
Coupling AC	Three Phase Setting	Output Waveform Selection			2014/12/17 16:00:21	Coupling AC	Output Waveform Selection			2014/12/17 16:01:16	

Notice

1. When setting Vac S/R = 0, F S/R = 0, Vdc S/R = 0, the output transient outputs in the highest speed.
2. Though the input range of Vac S/R, F S/R, Vdc S/R is quite large when using the software editor, the output voltage may not apply the slew rate properly due to the hardware limit when the Vac S/R, F S/R and Vdc S/R are too large. The maximum of Vac S/R and Vdc S/R is 1200V/ms and the minimum is 0.001V/ms. The maximum of F S/R is 1600Hz/ms and the minimum is 0.001Hz/ms.
3. When executing **OUT** on the Regenerative Grid Simulator the output will reach the final state as set. Once QUIT is executed, the output turns to 0V immediately. If the user wishes to output the set slew rate to 0V, it is necessary to key in 0V and press **ENTER** instead of pressing **QUIT** directly.

3.3.1.5 Output Degree of 3-Phase Voltage Output

On the other hand the Regenerative Grid Simulator is able to set the phase difference degree for 3-phase output voltage. For instance the phase difference among the 3 phases is 120 degree for the output voltage with 3-phase balance positive sequence as the figure shown below.

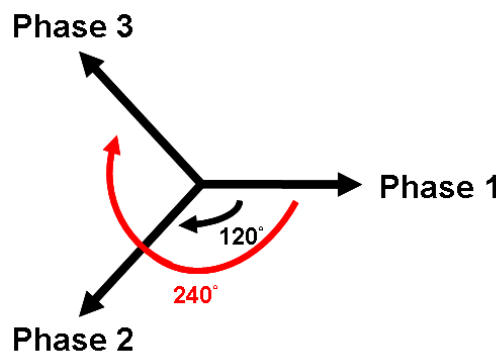

Following lists the procedure for setting the output voltage to 3-phase balance with 120 degree phase difference among the 3 phases.

1. Move the cursor to "Phase angle 1-2 =" command line.
2. Press **1**, **2**, **0** and **ENTER**.

3. Move the cursor to “Phase angle 1-3 =” command line.
4. Press **2**, **4**, **0** and **ENTER**.

3_Phase 300V LOCAL QUIT						
OUTPUT SETTING					Setting	
#1	Vac =	0.0V	F =	60.00Hz	OUTPUT: More Setting	
#2	Vac =	0.0V	F =	60.00Hz		
#3	Vac =	0.0V	F =	60.00Hz		
MORE SETTING					Measurement Setting	
#1	Waveform =	A			Waveform Viewer	
		SINE				
#2	Waveform =	A			Limitation	
		SINE				
#3	Waveform =	A			Output Mode	
		SINE				
ON Degree =		0.0	OFF Degree =		IMMED	
Vac S/R =		0.000V/ms	Vdc S/R =		0.000V/ms	
F S/R =		0.000Hz/ms				
Phase angle 1-2 =			120.0	Phase angle 1-3 =		240.0
Coupling	Range	Three Phase	Output			
AC	300V	Setting	Waveform			
			Selection			
					2014/08/23 13:49:05	

Notice

Since the 3-phase voltage output of the Regenerative Grid Simulator is running separately, it is able to set the phase difference of 3-phase output to unbalance, such as Phase angle 1-2 = 100, Phase angle 1-3 = 200.

3.3.1.6 Output Waveform Selection

The Regenerative Grid Simulator has two sets of unique waveforms, A and B. Each of them has sine, square, clipped sine waveforms and 30 sets of built-in waveforms along with 6 sets of user defined waveforms.

3_Phase LOCAL QUIT					
OUTPUT SETTING					Waveform
#1	Vac =	0.0V	F =	60.00Hz	Edit Each
#2	Vac =	0.0V	F =	60.00Hz	
#3	Vac =	0.0V	F =	60.00Hz	
MORE SETTING					View Waveform
#1	Waveform A =	SINE			View Waveform
	Waveform B =	SINE			
#2	Waveform A =	SINE			
	Waveform B =	SINE			
#3	Waveform A =	SINE			
	Waveform B =	SINE			
Coupling	Three Phase	Output			
AC	Setting	Waveform			
		Selection			
					2014/12/17 16:03:58

Follow the steps below to set the 3-phase waveform to A and to sine:

1. Press Edit on the right and use RPG to change the selection to All.
2. Move the cursor to WAVE A command line.
3. Turn the RPG to select “SINE” and press **ENTER**.

The user can press “View Waveform” on the right to view the set waveform.

3 Phase		LOCAL	QUIT		
OUTPUT SETTING					
#1	Vac =	0.0V	F =	60.00Hz	Waveform
#2	Vac =	0.0V	F =	60.00Hz	Edit Each
#3	Vac =	0.0V	F =	60.00Hz	
MORE SETTING					
#1	Waveform A =	SINE			View Waveform
	Waveform B =	SINE			
#2	Waveform A =	SINE			
	Waveform B =	SINE			
#3	Waveform A =	SINE			
	Waveform B =	SINE			
Coupling	Three Phase	Output			2014/12/17 16:03:58
AC	Setting	Waveform	Selection		

3 Phase		LOCAL	QUIT		
OUTPUT SETTING					
#1	Vac =	0.0V	F =	60.00Hz	Waveform
#2	Vac =	0.0V	F =	60.00Hz	Edit All
#3	Vac =	0.0V	F =	60.00Hz	
MORE SETTING					
#1	Waveform A =	SINE			View Waveform
	Waveform B =	SINE			
#2	Waveform A =	SINE			
	Waveform B =	SINE			
#3	Waveform A =	SINE			
	Waveform B =	SINE			
Coupling	Three Phase	Output			2014/12/17 16:05:35
AC	Setting	Waveform	Selection		

3 Phase		300V	LOCAL	QUIT		
OUTPUT SETTING						
#1	Vac =	0.0V	F =	60.00Hz	Waveform	
#2	Vac =	0.0V	F =	60.00Hz	Edit Each	
#3	Vac =	0.0V	F =	60.00Hz		
MORE SETTING						
#1	Waveform A =	SINE			View Waveform	
	Waveform B =	SINE				
#2	Waveform A =	SINE				
	Waveform B =	SINE				
#3	Waveform A =	SINE				
	Waveform B =	SINE				
Coupling	Range	Three Phase	Output			2014/08/23 13:51:40
AC	300V	Setting	Waveform	Selection		

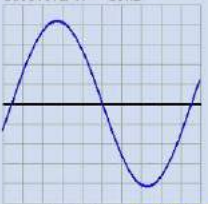
3 Phase		LOCAL	QUIT		
OUTPUT SETTING					
#1	Vac =	0.0V	F =	60.00Hz	Waveform
#2	Vac =	0.0V	F =	60.00Hz	
#3	Vac =	0.0V	F =	60.00Hz	
OUTPUT WAVEFORM A OF #1					
Waveform A = SINE					
					
Coupling	Three Phase	Output			2014/12/17 16:10:28
AC	Setting	Waveform	Selection		

Follow the steps below to set the A waveform of 3-phase to clipped sine with a total harmonic distortion of 35%.

1. Press Edit on the right and use RPG to change the selection to All.
2. Move the cursor to the WAVE A command line and select "CSIN".
3. The LCD screen to show MODE and PERCENT.
4. Turn the RPG to change MODE to "THD" and press **ENTER**.
5. Press **3**, **5** and **ENTER** to set the THD to be 35%.

3 Phase		300V	LOCAL	QUIT		
OUTPUT SETTING						
#1	Vac =	0.0V	F =	60.00Hz	Waveform	
#2	Vac =	0.0V	F =	60.00Hz	Edit All	
#3	Vac =	0.0V	F =	60.00Hz		
MORE SETTING						
#1	Waveform A =	SINE			View Waveform	
	Waveform B =	SINE				
#2	Waveform A =	SINE				
	Waveform B =	SINE				
#3	Waveform A =	SINE				
	Waveform B =	SINE				
Coupling	Range	Three Phase	Output			2014/08/23 13:52:34
AC	300V	Setting	Waveform	Selection		

3 Phase		300V	LOCAL	QUIT		
OUTPUT SETTING						
#1	Vac =	0.0V	F =	60.00Hz	Waveform	
#2	Vac =	0.0V	F =	60.00Hz	Edit All	
#3	Vac =	0.0V	F =	60.00Hz		
MORE SETTING						
#1	Waveform A =	CSIN	Mode =AMP	Percent = 35%	View Waveform	
	Waveform B =	SINE				
#2	Waveform A =	CSIN	Mode =AMP	Percent = 35%		
	Waveform B =	SINE				
#3	Waveform A =	CSIN	Mode =AMP	Percent = 35%		
	Waveform B =	SINE				
Coupling	Range	Three Phase	Output			2014/08/23 13:55:13
AC	300V	Setting	Waveform	Selection		

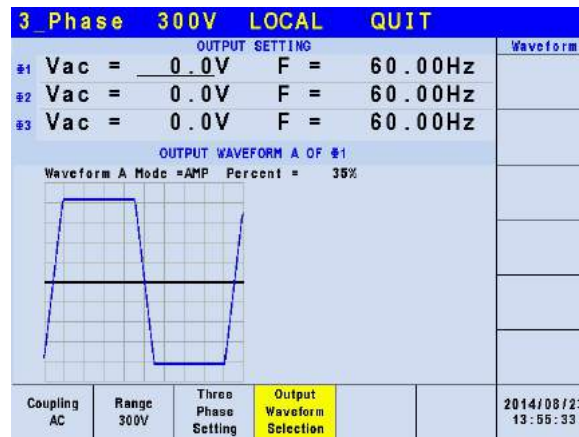

Notice

1. Clipped sine waveform can be programmed via “Amplitude” or “Total Harmonic Distortion”. The amplitude range is from 0 to 100% (100%: without clipping) while the Total Harmonic Distortion range is from 0 to 43% (0%: without distortion.)
2. The user defined waveform needs to be defined by and downloaded from the remote PC.
3. For detail DST waveform, please see *Appendix B Built-in DST Waveform*.

WARNING

1. When using the user defined waveform, it may damage the Regenerative Grid Simulator if the waveform frequency exceeds 100Hz.
2. Due to the bandwidth restriction of Regenerative Grid Simulator, distortion may occur on the output especially when the user defined waveform contains high frequency.
3. If the user defined waveform or the set DST waveform exceeds the voltage limit, OUTPUT OVP or DST Protection will occur.

3.3.2 Measurement Setting

Press Measurement Setting in the MAIN PAGE (3_Phase Mode/1_Phase Mode) to set the measurement as the figure shown below. There are 12 measurement items in the setting screen such as voltage, current, output power and etc. The setting is done by moving the cursor to each item and use the RPG to select the required test item and press **ENTER**.

Below is procedure to change the 3rd measurement item from Po to VA in 3-phase mode.

1. Press Measurement Setting in the MAIN PAGE (3_Phase Mode).
2. Move the cursor to “Po”.
3. Use the RPG to select “VA” and press **ENTER**.
4. Press  to return to the MAIN PAGE.

3_Phase		LOCAL		QUIT			
OUTPUT SETTING						Setting	
#1	Vac =	0.0V	F =	60.00Hz	OUTPUT: More Setting		
#2	Vac =	0.0V	F =	60.00Hz	Measurement Setting		
#3	Vac =	0.0V	F =	60.00Hz			
MEASUREMENT SETTING						Waveform Viewer	
#1	V	P ₀	Vac	Vdc	Vpk	VA	
#1	I	PF	Iac	Idc	Ipk	CF	
#2	V	P ₀	Vac	Vdc	Vpk	VA	Limitation
#2	I	PF	Iac	Idc	Ipk	CF	
#3	V	P ₀	Vac	Vdc	Vpk	VA	Output Mode
#3	I	PF	Iac	Idc	Ipk	CF	
Σ	V ₁₂	V ₂₃	V ₁₂	V ₂₃			
	V ₃₁	P ₀	V ₃₁	VA			
Average Times 1	Isurge Delay 10ms	Isurge Interval 10ms	Edit All			2014/12/17 16:19:41	

3_Phase		LOCAL		QUIT			
OUTPUT SETTING						Setting	
#1	Vac =	0.0V	F =	60.00Hz	OUTPUT: More Setting		
#2	Vac =	0.0V	F =	60.00Hz	Measurement Setting		
#3	Vac =	0.0V	F =	60.00Hz			
MEASUREMENT SETTING						Waveform Viewer	
#1	V	<u>VA</u>	Vac	Vdc	Vpk	VA	
#1	I	PF	Iac	Idc	Ipk	CF	
#2	V	P ₀	Vac	Vdc	Vpk	VA	Limitation
#2	I	PF	Iac	Idc	Ipk	CF	
#3	V	P ₀	Vac	Vdc	Vpk	VA	Output Mode
#3	I	PF	Iac	Idc	Ipk	CF	
Σ	V ₁₂	V ₂₃	V ₁₂	V ₂₃			
	V ₃₁	P ₀	V ₃₁	VA			
Average Times 1	Isurge Delay 10ms	Isurge Interval 10ms	Edit All			2014/12/17 16:20:39	

3_Phase		LOCAL		QUIT			
OUTPUT SETTING						Setting	
#1	Vac =	0.0V	F =	60.00Hz	OUTPUT: More Setting		
#2	Vac =	0.0V	F =	60.00Hz	Measurement Setting		
#3	Vac =	0.0V	F =	60.00Hz			
MEASUREMENT SETTING						Waveform Viewer	
#1	V	VA	<u>Vac</u>	Vdc	Vpk	VA	
#1	I	PF	Iac	Idc	Ipk	CF	
#2	V	VA	Vac	Vdc	Vpk	VA	Limitation
#2	I	PF	Iac	Idc	Ipk	CF	
#3	V	VA	Vac	Vdc	Vpk	VA	Output Mode
#3	I	PF	Iac	Idc	Ipk	CF	
Σ	V ₁₂	V ₂₃	V ₁₂	V ₂₃			
	V ₃₁	P ₀	V ₃₁	VA			
Average Times 1	Isurge Delay 10ms	Isurge Interval 10ms	Edit All			2014/12/17 16:22:47	

3_Phase		LOCAL		QUIT			
OUTPUT SETTING						Main	
#1	Vac =	0.0V	F =	60.00Hz	OUTPUT: More Setting		
#2	Vac =	0.0V	F =	60.00Hz	Measurement Setting		
#3	Vac =	0.0V	F =	60.00Hz			
MEASUREMENT						Waveform Viewer	
#1	V =	0.00	VA =	0.0			
#1	I =	0.000	P ₀ =	0.0			
#2	V =	0.00	P ₀ =	0.0			Limitation
#2	I =	0.000	PF =	0.000			
#3	V =	0.00	P ₀ =	0.0			Output Mode
#3	I =	0.000	PF =	0.000			
Σ	V ₁₂ =	0.00	V ₂₃ =	0.00			Measurement To Page2
	V ₃₁ =	0.00	P ₀ =	0.0			
Recall CH1	Recall CH2	Recall CH3	Recall CH4	Recall CH5	More 1 of 2	2014/12/17 16:25:53	

Below is the procedure to the 2nd measurement item from I to Iac in 1 phase mode.

1. Press Measurement Setting in the MAIN PAGE (1_Phase Mode).
2. Move the cursor to "I".
3. Use the RPG to select "Iac" and press **ENTER**.
4. Press  to return to the MAIN PAGE.

1_Phase		LOCAL		QUIT			
OUTPUT SETTING						Setting	
Vac = 0.0V F = 60.00Hz						OUTPUT: More Setting	
						Measurement Setting	
MEASUREMENT SETTING						Waveform Viewer	
	<u>V</u>	P ₀	Vac	Vdc	Vpk	VA	
	I	PF	Iac	Idc	Ipk	CF	
						Limitation	
						Output Mode	
Average Times 1	Isurge Start 10ms	Isurge Interval 10ms					2014/12/17 16:26:46

1_Phase		LOCAL		QUIT			
OUTPUT SETTING						Setting	
Vac = 0.0V F = 60.00Hz						OUTPUT: More Setting	
						Measurement Setting	
MEASUREMENT SETTING						Waveform Viewer	
	V	P ₀	<u>Vac</u>	Vdc	Vpk	VA	
	<u>Iac</u>	PF	Iac	Idc	Ipk	CF	
						Limitation	
						Output Mode	
Average Times 1	Isurge Start 10ms	Isurge Interval 10ms					2014/12/17 16:27:27

1_Phase LOCAL QUIT						1_Phase LOCAL QUIT					
OUTPUT SETTING						OUTPUT SETTING					
Vac = 0.0V F = 60.00Hz						Vac = 0.0V F = 60.00Hz					
MEASUREMENT SETTING						MEASUREMENT					
V	Po	Vac	Vdc	Vpk	VA	V	Po	Vac	Vdc	Vpk	VA
Iac	PF	Iac	Idc	Ipk	CF	Iac	PF	Iac	Idc	Ipk	CF
Average Times 1						Recall CH1 Recall CH2 Recall CH3 Recall CH4 Recall CH5 More 1 of 2					
2014/12/17 16:27:27						2014/12/17 16:28:57					

3.3.2.1 Average Times

Average Times is the sampling average of voltage/current RMS and voltage/current peak. The Regenerative Grid Simulator uses moving windows for sampling. When “4” is selected for Average Times it indicates it will be sampling 4 times in moving windows.

Press Average Times at the bottom to set the average times for sampling. When the measurement is fluctuated severely, higher sampling average times can be set to improve the measurement accuracy. The average times for sampling to be set are listed below.

Average Times: 1, 2, 4, 8, 16 and 32.

Follow the steps below to set the sampling average times to 1.

1. Press Average Times at the bottom.
2. Turn RPG to switch to “1” and press **ENTER**.

3_Phase LOCAL QUIT						3_Phase LOCAL QUIT						
OUTPUT SETTING						OUTPUT SETTING						
#1	Vac = 0.0V F = 60.00Hz					Setting						
#2	Vac = 0.0V F = 60.00Hz					OUTPUT: More Setting						
#3	Vac = 0.0V F = 60.00Hz					Measurement Setting						
MEASUREMENT SETTING						MEASUREMENT						
#1	V	Po	Vac	Vdc	Vpk	VA	V	Po	Vac	Vdc	Vpk	VA
#1	I	PF	Iac	Idc	Ipk	CF	I	PF	Iac	Idc	Ipk	CF
#2	V	Po	Vac	Vdc	Vpk	VA	V	Po	Vac	Vdc	Vpk	VA
#2	I	PF	Iac	Idc	Ipk	CF	I	PF	Iac	Idc	Ipk	CF
#3	V	Po	Vac	Vdc	Vpk	VA	V	Po	Vac	Vdc	Vpk	VA
#3	I	PF	Iac	Idc	Ipk	CF	I	PF	Iac	Idc	Ipk	CF
Σ	V12	V23	V12	V23			V12	V23	V12	V23		
	V31	Po	V31	VA			V31	Po	V31	VA		
Average Times	Isurge Delay	Isurge Interval	Edit Each							2014/12/17 16:30:36		
1	10ms	10ms										

3.3.2.2 Isurge Delay, Isurge Interval

The Isurge in Measurement Setting is the surge peak current output by the Regenerative Grid Simulator. Isurge measurement starts after Isurge Delay when the voltage output changes. The measurement time is set by Isurge Interval. These two functions can be set by Measurement Setting.

The procedure for setting Isurge Delay = 10 ms, Isurge Interval = 10 ms is described below.

1. Move the cursor to "Isurge Delay =" command line.
2. Press **1**, **0** and **ENTER** to change the value to "10.0".
3. Move the cursor to "Isurge Interval =" command line.
4. Press **1**, **0** and **ENTER** to change the value "10.0".

3_Phase		LOCAL		QUIT			
OUTPUT SETTING						Setting	
#1	Vac =	0.0V	F =	60.00Hz	OUTPUT: More Setting		
#2	Vac =	0.0V	F =	60.00Hz	OUTPUT: More Setting		
#3	Vac =	0.0V	F =	60.00Hz	Measurement Setting		
MEASUREMENT SETTING							
#1	V	Po	Vac	Vdc	Vpk	VA	Waveform Viewer
#1	I	PF	Iac	Idc	Ipk	CF	Waveform Viewer
#2	V	Po	Vac	Vdc	Vpk	VA	Limitation
#2	I	PF	Iac	Idc	Ipk	CF	Limitation
#3	V	Po	Vac	Vdc	Vpk	VA	Output Mode
#3	I	PF	Iac	Idc	Ipk	CF	Output Mode
	V12	V23	V12	V23			
Σ	V31	Po	V31	VA			
Average Times	Isurge Delay	Isurge Interval	Edit	2014/12/17 16:31:21			
1	10ms	10ms	Each				

3_Phase		LOCAL		QUIT			
OUTPUT SETTING						Setting	
#1	Vac =	0.0V	F =	60.00Hz	OUTPUT: More Setting		
#2	Vac =	0.0V	F =	60.00Hz	OUTPUT: More Setting		
#3	Vac =	0.0V	F =	60.00Hz	Measurement Setting		
MEASUREMENT SETTING							
#1	V	Po	Vac	Vdc	Vpk	VA	Waveform Viewer
#1	I	PF	Iac	Idc	Ipk	CF	Waveform Viewer
#2	V	Po	Vac	Vdc	Vpk	VA	Limitation
#2	I	PF	Iac	Idc	Ipk	CF	Limitation
#3	V	Po	Vac	Vdc	Vpk	VA	Output Mode
#3	I	PF	Iac	Idc	Ipk	CF	Output Mode
	V12	V23	V12	V23			
Σ	V31	Po	V31	VA			
Average Times	Isurge Delay	Isurge Interval	Edit	2014/12/17 16:35:01			
1	10ms	10ms	Each				

3.3.3 Waveform Viewer

Waveform Viewer can be used to see the real time output voltage/ current waveform. There are a total of 3 CH available. Voltage, current and time can be adjusted by the Scale command. The figure below shows the Waveform Viewer.

Ch1: Φ1V, Φ2V, Φ3V, Φ1I, Φ2I, Φ3I.

Ch2: Φ1V, Φ2V, Φ3V, Φ1I, Φ2I, Φ3I.

Ch3: Φ1V, Φ2V, Φ3V, Φ1I, Φ2I, Φ3I.

V Scale: 10, 20, 40, 80, 120V/div.

I Scale: 5, 10, 20, 40, 60A/div.

Time Scale: 0.2, 0.5, 1, 2, 5, 10, 50, 100, 200ms/div.

The procedure for setting CH1 =Φ1V, CH2 =Φ2V, CH3 =Φ3V, V Scale = 40 V/div, I Scale = 5A/div, Time Scale = 2 ms/div in 1_Phase Mode /3_Phase Mode is described as below.

1. Press CH1 at the bottom.
2. Turn the RPG to change to "Φ1V" and press **ENTER**.
3. Press CH2 at the bottom.
4. Turn the RPG to change to "Φ2V" and press **ENTER**.
5. Press CH3 at the bottom.
6. Turn the RPG to change to "Φ3V" and press **ENTER**.
7. Press V Scale at the bottom.
8. Turn the RPG to change to "40" and press **ENTER**.
9. Press I Scale at the bottom.
10. Turn the RPG to change to "5" and press **ENTER**.
11. Press Time Scale at the bottom.
12. Turn the RPG to change to "2" and press **ENTER**.

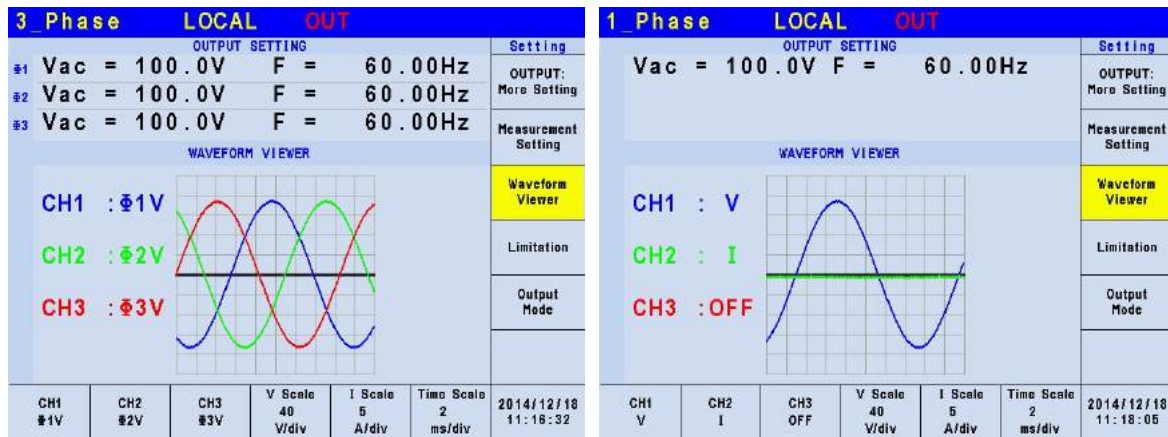

3.3.4 Limitation

The Limit of Regenerative Grid Simulator 1-phase/3-phase output mode is set separately. For instance, the Vac Limit setting will apply the settings of the 1-phase mode when changing it from the 3-phase mode.

3.3.4.1 Vac Limit

Vac Limit sets the Vac value in MAIN PAGE (3_Phase Mode/1_Phase Mode). Press Limitation on the right in MAIN PAGE (3_Phase Mode/1_Phase Mode) to set the Vac Limit. This command protects the planned program instead of the hardware.

Press Edit at the bottom to set the limitation of the 3-phase voltage output for “Each” or “All”.

The procedure to set Vac Limit = 300V in 1_Phase Mode /3_Phase Mode is described below.

1. Move the cursor to “Vac =” command line.
2. Press **[3]**, **[0]**, **[0]** and **[ENTER]** to change the value to “300.0”.

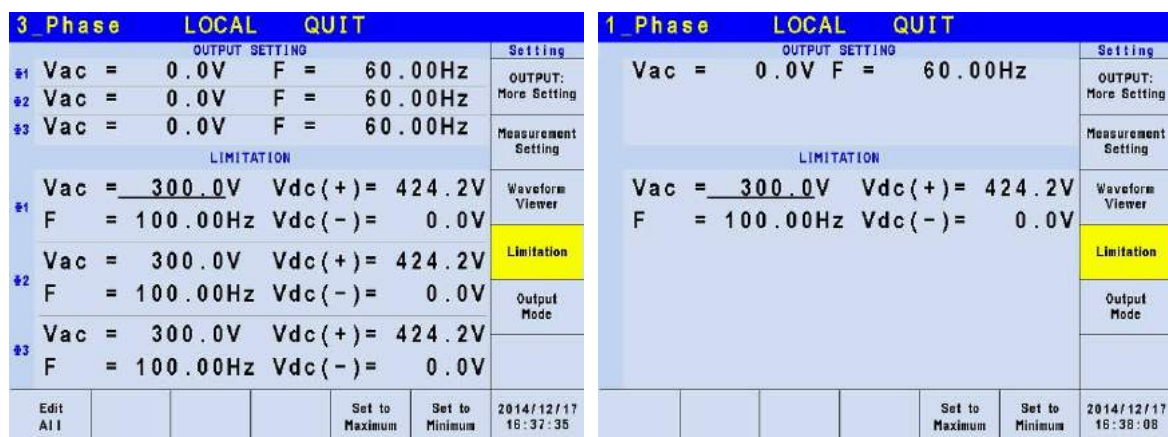

3.3.4.2 Vdc Limit (+), Vdc Limit (-)

Vdc Limit (+) and Vdc Limit (-) restrict the Vdc setting in MAIN PAGE (3_Phase Mode/1_Phase Mode). These two items can be set in the Limitation function (see 3.3.4). The Vdc setting can exceed Vdc Limit (+) but cannot be under Vdc Limit (-).

The procedure for setting Vdc (+) = 424.2V, Vdc (-) = 0V in 1_Phase Mode /3_Phase Mode is described below.

1. Move the cursor to "Vdc (+) =" command line.
2. Press **4**, **2**, **4**, **.**, **2** and **ENTER** to change the value to "424.2".
3. Move the cursor to "Vdc (-) =" command line.
4. Press **0** and **ENTER** to change the value to "0.0".

3_Phase 300V LOCAL QUIT						1_Phase 300V LOCAL QUIT						
OUTPUT SETTING						OUTPUT SETTING						
#1	Vac =	0.0V	F =	60.00Hz	Setting	Vac = 0.0V F = 60.00Hz						
#2	Vac =	0.0V	F =	60.00Hz	OUTPUT: More Setting							
#3	Vac =	0.0V	F =	60.00Hz	Measurement Setting							
LIMITATION						LIMITATION						
#1	Vac =	300.0V	Vdc (+) =	424.2V	Waveform Viewer	Vac = 300.0V Vdc (+) = 424.2V						
	F =	100.00Hz	Vdc (-) =	0.0V	Limitation	F = 100.00Hz Vdc (-) = 0.0V						
#2	Vac =	300.0V	Vdc (+) =	424.2V	Output Mode							
	F =	100.00Hz	Vdc (-) =	0.0V								
#3	Vac =	300.0V	Vdc (+) =	424.2V								
	F =	100.00Hz	Vdc (-) =	0.0V								
Edit Each				Set to Maximum	Set to Minimum	2014/05/16 17:11:32				Set to Maximum	Set to Minimum	2014/05/16 17:12:13

Notice

It should restrict the Vdc value when the output contains it. It may cause damage if the output polarity is reversed especially the load polarity.

CAUTION

1. If the set Limitation is smaller than the main menu setting, the set value in main menu will equal to the one set by Limitation when the setting is done.

Ex. (1) The original main menu sets Vac = 200V.

3_Phase LOCAL QUIT						Main
OUTPUT SETTING						OUTPUT: More Setting
#1	Vac =	200.0V	F =	60.00Hz	Vdc =	141.0V
#2	Vac =	200.0V	F =	60.00Hz	Vdc =	141.0V
#3	Vac =	200.0V	F =	60.00Hz	Vdc =	141.0V
MEASUREMENT						Measurement Setting
#1	V =	0.00	Po =	0.0	Waveform Viewer	
	I =	0.000	PF =	0.000	Limitation	
#2	V =	0.00	Po =	0.0	Output Mode	
	I =	0.000	PF =	0.000		
#3	V =	0.00	Po =	0.0		
	I =	0.000	PF =	0.000		
Σ	V ₁₂ =	0.00	V ₂₃ =	0.00	Measurement To Page2	
	V ₃₁ =	0.00	Po =	0.0		
Recall CH1	Recall CH2	Recall CH3	Recall CH4	Recall CH5	More 1 of 2	2014/12/18 10:30:16

- (2) The Limitation sets Vac Limit =100V.

3 Phase			LOCAL			QUIT	
OUTPUT SETTING							Setting
#1	Vac = 200.0V	F = 60.00Hz	Vdc = 141.0V				OUTPUT: More Setting
#2	Vac = 200.0V	F = 60.00Hz	Vdc = 141.0V				
#3	Vac = 200.0V	F = 60.00Hz	Vdc = 141.0V				
LIMITATION							Measurement Setting
#1	Vac = 100.0V	F = 100.00Hz	Vdc(+) = 424.2V	Vdc(-) = 0.0V			Waveform Viewer
#2	Vac = 100.0V	F = 100.00Hz	Vdc(+) = 424.2V	Vdc(-) = 0.0V			Limitation
#3	Vac = 100.0V	F = 100.00Hz	Vdc(+) = 424.2V	Vdc(-) = 0.0V			Output Mode
Edit All				Set to Maximum	Set to Minimum	2014/12/18 10:31:04	

(3) When return to the main menu, the value will be the one set by Limitation.

3 Phase			LOCAL			QUIT	
OUTPUT SETTING							Main
#1	Vac = 100.0V	F = 60.00Hz	Vdc = 141.0V				OUTPUT: More Setting
#2	Vac = 100.0V	F = 60.00Hz	Vdc = 141.0V				
#3	Vac = 100.0V	F = 60.00Hz	Vdc = 141.0V				
MEASUREMENT							Measurement Setting
#1	V = 0.00	I = 0.000	Po = 0.0	PF = 0.000			Waveform Viewer
#2	V = 0.00	I = 0.000	Po = 0.0	PF = 0.000			Limitation
#3	V = 0.00	I = 0.000	Po = 0.0	PF = 0.000			Output Mode
Σ	V12 = 0.00	V31 = 0.00	V23 = 0.00	Po = 0.0			Measurement To Page2
Recall CH1	Recall CH2	Recall CH3	Recall CH4	Recall CH5	More 1 of 2	2014/12/18 10:31:34	

2. When AC+DC is selected for Coupling output mode, the output voltage will be restricted by voltage specification.

Ex. (1) It is unable to the DC voltage if the AC voltage is set to maximum output voltage. If the AC voltage sets to Vac = 300V, it is unable to set the DC voltage to 0V.

3 Phase			LOCAL			QUIT	
OUTPUT SETTING							Setting
#1	Vac = 300.0V	F = 60.00Hz	Vdc = 0.0V				OUTPUT: More Setting
#2	Vac = 300.0V	F = 60.00Hz	Vdc = 0.0V				
#3	Vac = 300.0V	F = 60.00Hz	Vdc = 0.0V				
LIMITATION							Measurement Setting
#1	Vac = 300.0V	F = 100.00Hz	Vdc(+) = 424.2V	Vdc(-) = 0.0V			Waveform Viewer
#2	Vac = 300.0V	F = 100.00Hz	Vdc(+) = 424.2V	Vdc(-) = 0.0V			Limitation
#3	Vac = 300.0V	F = 100.00Hz	Vdc(+) = 424.2V	Vdc(-) = 0.0V			Output Mode
Edit All				Set to Maximum	Set to Minimum	2014/12/18 10:28:55	

(2) The DC voltage will limit to system protection point if the AC voltage is not set to the maximum output voltage specification. When the AC voltage

sets to Vac = 200V, the DC voltage can only set to 141V at a maximum.

3 Phase			LOCAL	QUIT		
OUTPUT SETTING					Main	
#1	Vac = 200.0V	F = 60.00Hz	Vdc = 141.0V		OUTPUT: More Setting	
#2	Vac = 200.0V	F = 60.00Hz	Vdc = 141.0V		Measurement Setting	
#3	Vac = 200.0V	F = 60.00Hz	Vdc = 141.0V			
MEASUREMENT					Waveform Viewer	
#1	V = 0.00	Po = 0.0			Limitation	
	I = 0.000	PF = 0.000				
#2	V = 0.00	Po = 0.0			Output Mode	
	I = 0.000	PF = 0.000				
#3	V = 0.00	Po = 0.0			Measurement To Page2	
	I = 0.000	PF = 0.000				
Σ	V ₁₂ = 0.00	V ₂₃ = 0.00				
	V ₃₁ = 0.00	Po = 0.0				
Recall CH1	Recall CH2	Recall CH3	Recall CH4	Recall CH5	More 1 of 2	2014/12/18 10:30:16

3.4 CONFIG Function Key

Press **CONFIG** in the **FUNCTION** keys shown below to enter into CONFIG function (3_Phase Mode/1_Phase Mode.)

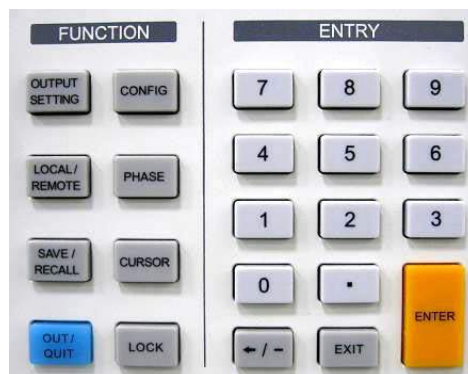

Figure 3-5 FUNCTION Keys

3 Phase			LOCAL	QUIT		
OUTPUT SETTING					Config	
#1	Vac = 0.0V	F = 60.00Hz			Interface	
#2	Vac = 0.0V	F = 60.00Hz			External Vref	
#3	Vac = 0.0V	F = 60.00Hz				
MEASUREMENT					Display	
#1	V = 0.00	Po = 0.0			PowerON Status	
	I = 0.000	PF = 0.000				
#2	V = 0.00	Po = 0.0			Protection	
	I = 0.000	PF = 0.000				
#3	V = 0.00	Po = 0.0			More 1 of 2	
	I = 0.000	PF = 0.000				
Σ	V ₁₂ = 0.00	V ₂₃ = 0.00				
	V ₃₁ = 0.00	Po = 0.0				
GPIB Address 30	RS232 Parity None	RS232 Baudrate 115200	Remote Inhibit Disable	EXT. ON/OFF Disable	Ethernet Setting	2014/12/17 16:40:44

1 Phase			LOCAL	QUIT		
OUTPUT SETTING					Config	
Vac = 0.0V		F = 60.00Hz			Interface	
MEASUREMENT					External Vref	
V = 0.00	Po = 0.0				Display	
I = 0.000	PF = 0.000					
Vac = 0.00	Vdc = 0.00				PowerON Status	
Iac = 0.000	Idc = 0.000					
Vpk = 0.00	VA = 0.0				Protection	
Ipk = 0.000	CF = 0.000					
More 1 of 2					More 1 of 2	
GPIB Address 30	RS232 Parity None	RS232 Baudrate 115200	Remote Inhibit Disable	EXT. ON/OFF Disable		Ethernet Setting

3.4.1 Interface

3.4.1.1 GPIB Address, RS-232 Parity/Baudrate

The Regenerative Grid Simulator also has remote operation mode that can be activated by the CONFIG function (3_Phase Mode/1_Phase Mode.) It is necessary to set GPIB address to 30 before conducting remote operation in 1_Phase Mode /3_Phase Mode.

1. Press GPIB address at the bottom.
2. Turn the RPG to change the address and press **ENTER** to set address 30.

3_Phase 300V LOCAL QUIT							1_Phase 300V LOCAL QUIT						
OUTPUT SETTING						Config	OUTPUT SETTING						Config
#1	Vac =	0.0V	F =	60.00Hz		Interface	Vac = 0.0V F = 60.00Hz						Interface
#2	Vac =	0.0V	F =	60.00Hz		External Vref							External Vref
#3	Vac =	0.0V	F =	60.00Hz									
MEASUREMENT						Display	MEASUREMENT						Display
#1	V =	0.00	Po =	0.0			V = 0.00	Po = 0.0					
	I =	0.000	PF =	0.000		PowerON Status	Vac = 0.00	Vdc = 0.00					
#2	V =	0.00	Po =	0.0			Iac = 0.000	Idc = 0.000					
	I =	0.000	PF =	0.000		Protection	Vpk = 0.00	VA = 0.0					
#3	I =	0.000	PF =	0.000			Ipk = 0.000	CF = 0.000					
	V ₁₂ =	0.00	V ₂₃ =	0.00		More 1 of 2							
Σ	V ₃₁ =	0.00	Po =	0.0									
GPIB Address	RS232 Parity	RS232 Baudrate	Remote Inhibit	EXT. ON/OFF	Ethernet Setting	2014/05/16 17:14:30	GPIB Address	RS232 Parity	RS232 Baudrate	Remote Inhibit	EXT. ON/OFF	Ethernet Setting	2014/05/16 17:15:09
30	None	115200	Disable	Disable			30	None	115200	Disable	Disable		

 **Notice** : The address range is from 1 to 30.

The Regenerative Grid Simulator uses the RS-232C bus to provide remote operation. Follow the steps below to set the communication protocol. Set Parity=None and Baudrate =115200 in 1_Phase Mode /3_Phase Mode as described below:

1. Press RS232 Parity at the bottom.
2. Turn the RPG to select None and press **ENTER**.
3. Press RS232 Baudrate at the bottom. Turn the RPG to “115200” and press **ENTER**.

1_Phase LOCAL QUIT							1_Phase LOCAL QUIT						
OUTPUT SETTING						Config	OUTPUT SETTING						Config
Vac = 0.0V F = 60.00Hz						Interface	Vac = 0.0V F = 60.00Hz						Interface
MEASUREMENT						External Vref	MEASUREMENT						External Vref
	V =	0.00	Po =	0.0			V = 0.00	Po = 0.0					
	I =	0.000	PF =	0.000		Display	Vac = 0.00	Vdc = 0.00					
	Vac =	0.00	Vdc =	0.00			Iac = 0.000	Idc = 0.000					
	Iac =	0.000	Idc =	0.000		PowerON Status	Vpk = 0.00	VA = 0.0					
	Vpk =	0.00	VA =	0.0			Ipk = 0.000	CF = 0.000					
	Ipk =	0.000	CF =	0.000		Protection							
							More 1 of 2						
GPIB Address	RS232 Parity	RS232 Baudrate	Remote Inhibit	EXT. ON/OFF	Ethernet Setting	2014/12/17 16:42:29		GPIB Address	RS232 Parity	RS232 Baudrate	Remote Inhibit	EXT. ON/OFF	Ethernet Setting
30	None	115200	Disable	Disable			30	None	115200	Disable	Disable		

1 Phase LOCAL QUIT						1 Phase LOCAL QUIT									
OUTPUT SETTING						OUTPUT SETTING									
Vac = 0.0V F = 60.00Hz						Vac = 0.0V F = 60.00Hz									
MEASUREMENT						MEASUREMENT									
V = 0.00		Po = 0.0		I = 0.000		PF = 0.000		V = 0.00		Po = 0.0		I = 0.000		PF = 0.000	
Vac = 0.00		Vdc = 0.00		Iac = 0.000		Idc = 0.000		Vac = 0.00		Vdc = 0.00		Iac = 0.000		Idc = 0.000	
Vpk = 0.00		VA = 0.0		Ipk = 0.000		CF = 0.000		Vpk = 0.00		VA = 0.0		Ipk = 0.000		CF = 0.000	
GPB Address 30						GPB Address 30									
RS232 Parity None						RS232 Parity None									
RS232 Baudrate 9600						RS232 Baudrate 57600									
Remote Inhibit Disable						Remote Inhibit Disable									
EXT. ON/OFF Disable						EXT. ON/OFF Disable									
Ethernet Setting 2014/12/17 16:44:40						Ethernet Setting 2014/12/17 16:45:13									



Notice

The baudrate selections are 9600/19200/38400/57600/115200 and the selections for parity are EVEN/ODD/NON.

3.4.1.2 Remote Inhibit, EXT. ON/OFF

The output of Regenerative Grid Simulator can be inhibited by external control or manual trigger. The output signal of the remote inhibit (remote control) is received from the TTL terminal on the rear panel (see *Appendix A*.) Remote Inhibit and EXT. ON/OFF are set by the CONFIG function (3_Phase Mode/1_Phase Mode). There are two remote inhibit output states: Enable and Disable.

Remote Inhibit: When the Remote Inhibit is enabled on the Regenerative Grid Simulator and the Remote Inhibit signal is LOW, the Regenerative Grid Simulator will disable the output. The Regenerative Grid Simulator holds the output disabled even when the Remote Inhibit signal turns to HIGH. In order to re-enable the output, the user must press **OUT/QUIT**.

EXT. ON/OFF: When the EXT. ON/OFF is enabled on the Regenerative Grid Simulator and the EXT. ON/OFF signal is LOW, the Regenerative Grid Simulator will disable the output. The Regenerative Grid Simulator will re-enable the output when the EXT. ON/OFF signal turns to HIGH.

The procedure for setting Remote Inhibit/EXT. ON/OFF to disable in 1_Phase Mode /3_Phase Mode is described below.

1. Press Remote Inhibit/EXT. ON/OFF at the bottom.
2. Turn the RPG to change to "Disable" and press **ENTER**.

3 Phase LOCAL QUIT							Config
OUTPUT SETTING							Interface
#1	Vac =	0.0V	F =	60.00Hz			
#2	Vac =	0.0V	F =	60.00Hz			
#3	Vac =	0.0V	F =	60.00Hz			External Vref
MEASUREMENT							Display
#1	V =	0.00	P ₀ =	0.0			
	I =	0.000	PF =	0.000			PowerON Status
#2	V =	0.00	P ₀ =	0.0			Protection
	I =	0.000	PF =	0.000			
#3	V =	0.00	P ₀ =	0.0			More 1 of 2
	I =	0.000	PF =	0.000			
Σ	V ₁₂ =	0.00	V ₂₃ =	0.00			
	V ₃₁ =	0.00	P ₀ =	0.0			
GPiB Address	RS232 Parity	RS232 Baudrate	Remote Inhibit	EXT. ON/OFF	Ethernet Setting	2014/12/17 16:46:15	
30	None	115200	Disable	Disable			

1 Phase LOCAL QUIT							Config
OUTPUT SETTING							Interface
Vac =	0.0V	F =	60.00Hz				
MEASUREMENT							Display
V =	0.00	P ₀ =	0.0				
I =	0.000	PF =	0.000				PowerON Status
Vac =	0.00	Vdc =	0.00				Protection
Iac =	0.000	Idc =	0.000				
Vpk =	0.00	VA =	0.0				More 1 of 2
Ipk =	0.000	CF =	0.000				
GPiB Address	RS232 Parity	RS232 Baudrate	Remote Inhibit	EXT. ON/OFF	Ethernet Setting	2014/12/17 16:47:48	
30	None	115200	Disable	Disable			

3 Phase LOCAL QUIT							Config
OUTPUT SETTING							Interface
#1	Vac =	0.0V	F =	60.00Hz			
#2	Vac =	0.0V	F =	60.00Hz			
#3	Vac =	0.0V	F =	60.00Hz			External Vref
MEASUREMENT							Display
#1	V =	0.00	P ₀ =	0.0			
	I =	0.000	PF =	0.000			PowerON Status
#2	V =	0.00	P ₀ =	0.0			Protection
	I =	0.000	PF =	0.000			
#3	V =	0.00	P ₀ =	0.0			More 1 of 2
	I =	0.000	PF =	0.000			
Σ	V ₁₂ =	0.00	V ₂₃ =	0.00			
	V ₃₁ =	0.00	P ₀ =	0.0			
GPiB Address	RS232 Parity	RS232 Baudrate	Remote Inhibit	EXT. ON/OFF	Ethernet Setting	2014/12/17 16:46:55	
30	None	115200	Disable	Disable			

1 Phase LOCAL QUIT							Config
OUTPUT SETTING							Interface
Vac =	0.0V	F =	60.00Hz				
MEASUREMENT							Display
V =	0.00	P ₀ =	0.0				
I =	0.000	PF =	0.000				PowerON Status
Vac =	0.00	Vdc =	0.00				Protection
Iac =	0.000	Idc =	0.000				
Vpk =	0.00	VA =	0.0				More 1 of 2
Ipk =	0.000	CF =	0.000				
GPiB Address	RS232 Parity	RS232 Baudrate	Remote Inhibit	EXT. ON/OFF	Ethernet Setting	2014/12/17 16:48:29	
30	None	115200	Disable	Disable			

Notice

The output of the Remote Inhibit (Remote Control) transmits the TTL signals via a special I/O connector. See *Appendix A* for the detail TTL signal pin assignments.

3.4.1.3 Ethernet Setting

The Regenerative Grid Simulator can be operated remotely through a network once the Ethernet Settings are complete.

Network Setting: Auto, Manual

The procedure for setting Network Settings manually in 1_Phase Mode/3_Phase Mode is described below.

1. Press Ethernet setting at the bottom.
2. Move the cursor to "Network Setting:."
3. Turn the RPG to change to Manual and press **ENTER**.
4. Set the IP Address, Net Mask and Gateway.

3 Phase		LOCAL	QUIT			
OUTPUT SETTING						
#1	Vac =	0.0V	F =	60.00Hz	Config Set	
#2	Vac =	0.0V	F =	60.00Hz		
#3	Vac =	0.0V	F =	60.00Hz		
NETWORK SETTING						
Network Setting: Auto						
IP Address : 10 . 1 . 7 . 86						
Net Mask : 255 . 255 . 254 . 0						
Gateway : 10 . 1 . 7 . 254						
LAN Status = SETTING.....						
GPIB Address	RS232 Parity	RS232 Baudrate	Remote Inhibit	EXT. ON/OFF	Ethernet Setting	2014/12/17 17:00:08
30	None	115200	Disable	Disable		

3 Phase		LOCAL	QUIT			
OUTPUT SETTING						
#1	Vac =	0.0V	F =	60.00Hz	Config Set	
#2	Vac =	0.0V	F =	60.00Hz		
#3	Vac =	0.0V	F =	60.00Hz		
NETWORK SETTING						
Network Setting: Manual						
IP Address : 10 . 1 . 7 . 86						
Net Mask : 255 . 255 . 254 . 0						
Gateway : 10 . 1 . 7 . 254						
LAN Status = SETTING.....						
GPIB Address	RS232 Parity	RS232 Baudrate	Remote Inhibit	EXT. ON/OFF	Ethernet Setting	2014/12/17 17:00:53
30	None	115200	Disable	Disable		

3 Phase		LOCAL	QUIT			
OUTPUT SETTING						
#1	Vac =	0.0V	F =	60.00Hz	Config Set	
#2	Vac =	0.0V	F =	60.00Hz		
#3	Vac =	0.0V	F =	60.00Hz		
NETWORK SETTING						
Network Setting: Manual						
IP Address : 10 . 1 . 7 . 86						
Net Mask : 255 . 255 . 254 . 0						
Gateway : 10 . 1 . 7 . 254						
LAN Status = READY						
GPIB Address	RS232 Parity	RS232 Baudrate	Remote Inhibit	EXT. ON/OFF	Ethernet Setting	2014/12/17 17:01:43
30	None	115200	Disable	Disable		

1 Phase		LOCAL	QUIT			
OUTPUT SETTING						
Vac =		0.0V	F =	60.00Hz	Config Set	
NETWORK SETTING						
Network Setting: Auto						
IP Address : 10 . 1 . 7 . 86						
Net Mask : 255 . 255 . 254 . 0						
Gateway : 10 . 1 . 7 . 254						
LAN Status = SETTING.....						
GPIB Address	RS232 Parity	RS232 Baudrate	Remote Inhibit	EXT. ON/OFF	Ethernet Setting	2014/12/17 17:03:03
30	None	115200	Disable	Disable		

1 Phase		LOCAL	QUIT			
OUTPUT SETTING						
Vac =		0.0V	F =	60.00Hz	Config Set	
NETWORK SETTING						
Network Setting: Manual						
IP Address : 10 . 1 . 7 . 86						
Net Mask : 255 . 255 . 254 . 0						
Gateway : 10 . 1 . 7 . 254						
LAN Status = SETTING.....						
GPIB Address	RS232 Parity	RS232 Baudrate	Remote Inhibit	EXT. ON/OFF	Ethernet Setting	2014/12/17 17:03:41
30	None	115200	Disable	Disable		

1 Phase		LOCAL	QUIT			
OUTPUT SETTING						
Vac =		0.0V	F =	60.00Hz	Config Set	
NETWORK SETTING						
Network Setting: Manual						
IP Address : 10 . 1 . 7 . 86						
Net Mask : 255 . 255 . 254 . 0						
Gateway : 10 . 1 . 7 . 254						
LAN Status = READY						
GPIB Address	RS232 Parity	RS232 Baudrate	Remote Inhibit	EXT. ON/OFF	Ethernet Setting	2014/12/17 17:05:01
30	None	115200	Disable	Disable		

3.4.2 External Vref

The Regenerative Grid Simulator allows the user to use analog control signals (simulated) from an external device to set its output (optional card is required.) The External Vref terminal socket at the rear panel allows users to apply signals to the Regenerative Grid Simulator for output voltage setting. The External Vref and the Control Method can be set by the CONFIG function (3_Phase Mode/1_Phase Mode). External Vref has two coupled modes to indicate the output of Regenerative Grid Simulator: Amplifier and Level. When the user is using single phase Ext. Vref, the signal inputted by terminal pin Ext-V Φ2 is the main control signal. Refer to *Appendix A* for the pin assignment of TTL terminal. The voltage phase difference from External-V Reference signal input to external output is 100us.

Amplifier: The output voltage (V_{out}) is the composition of the voltage set in MAIN PAGE and the supplemental programmed voltage inputted externally. The external V reference voltage range is from -10 V to 10V. When $V_{ac}=0$ and $V_{dc}=0$ in MAIN PAGE, the following formula can be used to calculate V_{out} .

$$V_{out} (dc) = V_{ref} (dc) / 10 V_{dc} \times 424.2 V_{dc}$$

or

$$V_{out} (ac) = V_{ref} (ac) / 7.072 V_{ac} \times 300 V_{ac}$$

Ex (1): Set V_{out} to 100Vdc:

The applied external output voltage is $V = 2.357V_{dc}$, $V_{out} = 100V_{dc}$

Ex (2): Set V_{out} to 100Vac:

The applied external output voltage is $V = 2.357V_{ac}$, $V_{out} = 100V_{ac}$

Level: It is the linear proportional output of output voltage ($V_{out} (ac)$) RMS programmed by the DC V reference. The Vreference range is from -10V to 10V. The following formula can be used to calculate V_{out} :

$$V_{out} (ac) = | V_{ref} (dc) | / 10 V_{dc} \times 300V_{ac}$$

Ex (1): Set V_{out} to 100Vac:

The applied external output voltage is $V = 3.333V_{dc}$ (or $-3.333V_{dc}$), $V_{out} = 100V_{ac}$

The setting of Ext. Vref Control = OFF, Control Method = Amplifier is described below.

1. Press Ext. Vref Control at the bottom.
2. Turn the RPG to change ON to OFF and press **ENTER**.
3. Press Control Method at the bottom.
4. Turn the RPG to select Amplifier and press **ENTER**.

3 Phase 300V LOCAL QUIT						Config
OUTPUT SETTING						Interface
#1	Vac =	0.0V	F =	60.00Hz		
#2	Vac =	0.0V	F =	60.00Hz		
#3	Vac =	0.0V	F =	60.00Hz		External Vref
MEASUREMENT						Display
#1	V =	0.00	Po =	0.0		
	I =	0.000	PF =	0.000		PowerON Status
#2	V =	0.00	Po =	0.0		
	I =	0.000	PF =	0.000		Protection
#3	V =	0.00	Po =	0.0		
	I =	0.000	PF =	0.000		More 1 of 2
Σ	V ₁₂ =	0.00	V ₂₃ =	0.00		
	V ₃₁ =	0.00	Po =	0.0		
Ext.Vref Control	Control Method					2014/05/16 17:35:31
Off	Amplifier					

3 Phase 300V LOCAL QUIT						Config
OUTPUT SETTING						Interface
#1	Vac =	0.0V	F =	60.00Hz		
#2	Vac =	0.0V	F =	60.00Hz		
#3	Vac =	0.0V	F =	60.00Hz		External Vref
MEASUREMENT						Display
#1	V =	0.00	Po =	0.0		
	I =	0.000	PF =	0.000		PowerON Status
#2	V =	0.00	Po =	0.0		
	I =	0.000	PF =	0.000		Protection
#3	V =	0.00	Po =	0.0		
	I =	0.000	PF =	0.000		More 1 of 2
Σ	V ₁₂ =	0.00	V ₂₃ =	0.00		
	V ₃₁ =	0.00	Po =	0.0		
Ext.Vref Control	Control Method					2014/05/16 17:35:52
Off	Amplifier					

3 Phase 300V LOCAL QUIT						Config
OUTPUT SETTING						Interface
#1	Vac =	0.0V	F =	60.00Hz		
#2	Vac =	0.0V	F =	60.00Hz		
#3	Vac =	0.0V	F =	60.00Hz		External Vref
MEASUREMENT						Display
#1	V =	0.00	Po =	0.0		
	I =	0.000	PF =	0.000		PowerON Status
#2	V =	0.00	Po =	0.0		
	I =	0.000	PF =	0.000		Protection
#3	V =	0.00	Po =	0.0		
	I =	0.000	PF =	0.000		More 1 of 2
Σ	V ₁₂ =	0.00	V ₂₃ =	0.00		
	V ₃₁ =	0.00	Po =	0.0		
Ext.Vref Control	Control Method					2014/05/16 17:38:12
Off	Amplifier					

Notice

When Ext. Vref Control =ON, Control Method =Level, the output voltage (Vout) can only be controlled by the level of the external DC programming voltage. It is unable to control the Vout amplitude from the front panel keys until Ext. Vref Control=OFF is set.

WARNING

- When Control Method = Amplifier and the Vref frequency exceeds 1000Hz, it could damage the Regenerative Grid Simulator. The user should obey the following formula:
When set to **Amplifier** mode, $F > 100\text{Hz}$: must be $V_{ref} (\text{pk-pk, V}) F (\text{Vref, Hz}) < 4000 \text{ VHz}$.
When set to **Level** mode, $F > 100\text{Hz}$: must be $V_{ref} (\text{pk-pk, V}) F (\text{Vref, Hz}) < 2000 \text{ VHz}$.
- The output may be distorted due to the bandwidth restriction of Regenerative Grid Simulator, especially when the external V reference has too many high frequency components.
- If the output voltage is over the limit, OUTPUT OVP or DST Protection will occur.

3.4.3 Display

The brightness of the backlight and power save mode settings of the LCD can be set in the CONFIG function (3_Phase Mode/1_Phase Mode.)

Style: Default.

Backlight: Low, Medium and High.

Backlight OFF after: Never, 1 min, 3 mins, 5 mins, 10 mins, 30 mins, 1 hour and 3 hours.

The procedure for setting Backlight = Medium, Backlight OFF after = Never in 1_Phase Mode /3_Phase Mode is listed below.

1. Press Backlight at the bottom.
2. Turn the RPG to Medium and press **ENTER**.
3. Press Backlight OFF after at the bottom.
4. Turn the RPG to select Never and press **ENTER**.

3_Phase LOCAL QUIT				1_Phase LOCAL QUIT			
OUTPUT SETTING				OUTPUT SETTING			
#1	Vac = 0.0V	F = 60.00Hz	Config	Vac = 0.0V	F = 60.00Hz	Config	
#2	Vac = 0.0V	F = 60.00Hz	Interface			Interface	
#3	Vac = 0.0V	F = 60.00Hz	External Vref			External Vref	
MEASUREMENT				MEASUREMENT			
#1	V = 0.00	Po = 0.0	Display	V = 0.00	Po = 0.0	Display	
	I = 0.000	PF = 0.000		I = 0.000	PF = 0.000		
#2	V = 0.00	Po = 0.0	PowerON Status	Vac = 0.00	Vdc = 0.00	PowerON Status	
	I = 0.000	PF = 0.000		Iac = 0.000	Idc = 0.000		
#3	V = 0.00	Po = 0.0	Protection	Vpk = 0.00	VA = 0.0	Protection	
	I = 0.000	PF = 0.000		Ipk = 0.000	CF = 0.000		
	V ₁₂ = 0.00	V ₂₃ = 0.00	More 1 of 2			More 1 of 2	
	V ₃₁ = 0.00	Po = 0.0					
Style Default	Backlight Medium	Backlight OFF after Never		Style Default	Backlight Medium	Backlight OFF after Never	
			2014/12/17 17:08:42				2014/12/17 17:09:27

3.4.4 Power ON Status

The user can set the output state of Regenerative Grid Simulator during power on using the Power ON Status in the CONFIG function (3_Phase Mode/1_Phase Mode). Once it is set users should save the data before power off. With the output set to Off, the Regenerative Grid Simulator will not enable the output voltage after it is powered on. With it set to On, the Regenerative Grid Simulator will enable the output by default after powered on.

3_Phase LOCAL QUIT				3_Phase LOCAL QUIT			
OUTPUT SETTING				OUTPUT SETTING			
#1	Vac = 0.0V	F = 60.00Hz	Config	#1	Vac = 0.0V	F = 60.00Hz	Config
#2	Vac = 0.0V	F = 60.00Hz	Interface	#2	Vac = 0.0V	F = 60.00Hz	Interface
#3	Vac = 0.0V	F = 60.00Hz	External Vref	#3	Vac = 0.0V	F = 60.00Hz	External Vref
POWER ON STATUS SETTING				POWER ON STATUS SETTING			
#1	Vac = 0.0V	F = 60.00Hz	Display	#1	Vac = 0.0V	F = 60.00Hz	Display
	Vdc = 0.0V				Vdc = 0.0V		
	Vac = 0.0V	F = 60.00Hz	PowerON Status		Vac = 0.0V	F = 60.00Hz	PowerON Status
#2	Vdc = 0.0V			#2	Vdc = 0.0V		
	Vac = 0.0V	F = 60.00Hz	Protection		Vac = 0.0V	F = 60.00Hz	Protection
	Vdc = 0.0V				Vdc = 0.0V		
#3	Vac = 0.0V	F = 60.00Hz	More 1 of 2	#3	Vac = 0.0V	F = 60.00Hz	More 1 of 2
	Vdc = 0.0V				Vdc = 0.0V		
Output Off	Edit All			Output Off	Edit All		
			2014/12/17 17:12:35				2014/12/17 17:13:10

3 Phase		LOCAL	QUIT		
OUTPUT SETTING					
#1	Vac =	0.0V	F =	60.00Hz	Config
#2	Vac =	0.0V	F =	60.00Hz	Interface
#3	Vac =	0.0V	F =	60.00Hz	External Vref
POWER ON STATUS SETTING					
#1	Vac =	0.0V	F =	60.00Hz	Display
	Vdc =	0.0V			PowerON Status
#2	Vac =	0.0V	F =	60.00Hz	Protection
	Vdc =	0.0V			
#3	Vac =	0.0V	F =	60.00Hz	More 1 of 2
	Vdc =	0.0V			
Output Off	Edit Each				2014/12/17 17:14:10

1 Phase		LOCAL	QUIT		
OUTPUT SETTING					
	Vac =	0.0V	F =	60.00Hz	Config
POWER ON STATUS SETTING					
	Vac =	0.0V	F =	60.00Hz	Display
	Vdc =	0.0V			PowerON Status
Protection					
More 1 of 2					
Output Off					2014/12/17 17:15:29

3.4.5 Protection

The Regenerative Grid Simulator's Protection for 1-phase/3-phase output mode is set separately. For instance, the Protection will apply the settings of 1-phase when switching from 3-phase to 1-phase mode rather than the Protection settings of any phase under 3-phase mode.

The Protection in the CONFIG function (3_Phase Mode/1_Phase Mode) is able to set the limit of the output RMS current (OCP), output power (OPP) and the Delay Time for triggering the current protection. The limit in this command is to protect the program instead of the hardware.

Following shows the procedure of setting the current limit = 100A (50A for 61830; 75A for 61845; 100A for 61860), power limit = 20000VA (10000VA for 61830; 15000VA for 61845; 20000VA for 61860), delay time for trigger current protection = 3 sec.

1. Move the cursor to "OCP =" command line.
2. Press **1**, **0**, **0** and **ENTER** to change the value to "100.0".
3. Move the cursor to "OPP =" command line.
4. Press **2**, **0**, **0**, **0**, **0**, **ENTER** to change the value to "20000.0".
5. Move the cursor to "Delay time =" command line.
6. Press **3**, **ENTER** to change the value to "3.0".

3_Phase		LOCAL	QUIT		
OUTPUT SETTING					
#1	Vac =	0.0V	F =	60.00Hz	Config
#2	Vac =	0.0V	F =	60.00Hz	Interface
#3	Vac =	0.0V	F =	60.00Hz	External Vref
PROTECTION SETTING					
#1	OCP =	100.0A	OPP =	20000.0VA	Display
	OCP delay time =	3.0sec			PowerON Status
#2	OCP =	100.0A	OPP =	20000.0VA	Protection
	OCP delay time =	3.0sec			
#3	OCP =	100.0A	OPP =	20000.0VA	More 1 of 2
	OCP delay time =	3.0sec			
Edit All			Set to Maximum	Set to Minimum	2014/12/17 17:18:56

Notice

1. When “OCP = 0.0 A”, it means the limit of output current equals to the specification limit.
2. The setting of the delay time for trigger current protection is only valid when the current is within the specification. When the output exceeds the specification, it is still valid if the current protection delay trigger is between the set 0.1 to 1s. However, it will go into protection when it is over 1s. The resolution is 0.1s.
3. When switched to ACL mode (option), set the current limit example = 105A (max. 55A for 61830, max. 80A for 61845, and max. 105A for 61860), set the power limit example = 21000VA (max. 11000VA for 61830, max. 16000VA for 61845, and max. 21000VA for 61860).

Notice

The protection point varies by the measurement error, thus it may act before reaching the protection point set.

3.4.6 Others

Press MORE on the right in CONFIG function (3_Phase Mode/1_Phase Mode) to go to the second page and press Others on the right to set Output Relay, Buzzer, Date/Time and Remote Sense.

Output Relay: Depend and Always ON.

Buzzer: on and off.

Date/Time: Year, Month, Day, Hour, Minute and Second.

Remote Sense: on, off.

3 Phase		LOCAL		QUIT			
OUTPUT SETTING						Config	
#1	Vac =	0.0V	F =	60.00Hz	Others		
#2	Vac =	0.0V	F =	60.00Hz	Calibration		
#3	Vac =	0.0V	F =	60.00Hz	System Information		
MEASUREMENT						Factory Default	
#1	V =	0.00	P _o =	0.0	Master/Slave Function		
	I =	0.000	PF =	0.000	More 2 of 2		
#2	V =	0.00	P _o =	0.0			
	I =	0.000	PF =	0.000			
#3	V =	0.00	P _o =	0.0			
	I =	0.000	PF =	0.000			
Σ	V ₁₂ =	0.00	V ₂₃ =	0.00			
	V ₃₁ =	0.00	P _o =	0.0			
Output Relay Depend.	Buzzer On	Date/Time	Remote Sense On			2014/12/17 17:20:05	

1 Phase		LOCAL		QUIT			
OUTPUT SETTING						Config	
Vac =		0.0V	F =	60.00Hz	Others		
MEASUREMENT						Calibration	
V =	0.00	P _o =	0.0	System Information			
I =	0.000	PF =	0.000	Factory Default			
Vac =	0.00	Vdc =	0.00	Master/Slave Function			
Iac =	0.000	Idc =	0.000	More 2 of 2			
Vpk =	0.00	VA =	0.0				
Ipk =	0.000	CF =	0.000				
Output Relay Depend.	Buzzer On	Date/Time	Remote Sense On			2014/12/17 17:20:50	

The output circuit on the Regenerative Grid Simulator has a relay to connect to the load. When the output relay is “Always ON”, it indicates the output relay is closed (connected) even if the Regenerative Grid Simulator output state is in QUIT mode. When the output relay is “Depend.”, it indicates the output relay is closed (connected) only when the output state is in OUT mode. If the output state is in QUIT mode, the output relay will be opened (disconnected.) Output relay can be set in the SETUP function.

The procedure for setting the output relay to Always ON in 1_Phase Mode /3_Phase Mode is described below.

1. Press Output Relay at the bottom.
2. Turn the RPG to set the output relay to Always ON and press **ENTER**. When the output

relay is working, the Regenerative Grid Simulator will click once.

3 Phase 300V LOCAL QUIT				1 Phase 300V LOCAL QUIT			
OUTPUT SETTING				OUTPUT SETTING			
#1	Vac =	0.0V	F = 60.00Hz	Vac = 0.0V		F = 60.00Hz	
#2	Vac =	0.0V	F = 60.00Hz	Vac = 0.0V		F = 60.00Hz	
#3	Vac =	0.0V	F = 60.00Hz	Vac = 0.0V		F = 60.00Hz	
MEASUREMENT				MEASUREMENT			
#1	V =	0.00	Po = 0.0	V = 0.00	Po = 0.0		
	I =	0.000	PF = 0.000	I = 0.000	PF = 0.000		
#2	V =	0.00	Po = 0.0	Vac = 0.00	Vdc = 0.00		
	I =	0.000	PF = 0.000	Iac = 0.000	Idc = 0.000		
#3	V =	0.00	Po = 0.0	Vpk = 0.00	VA = 0.0		
	I =	0.000	PF = 0.000	Ipk = 0.000	CF = 0.000		
Σ	V ₁₂ =	0.00	V ₂₃ = 0.00				
	V ₃₁ =	0.00	Po = 0.0				
Output Relay	Buzzer	Date/Time	Remote Sense	Output Relay	Buzzer	Date/Time	Remote Sense
Always ON	On		On	Always ON	On		On
2014/05/16 17:46:48				2014/05/16 17:47:21			

Notice

Check if the Regenerative Grid Simulator has voltage output before powering it off. To ensure the safety of hardware, it is prohibited to power off the Regenerative Grid Simulator in Output state.

Next, the Regenerative Grid Simulator buzzer beeps when the panel keys are pressed or the RPG rotary is turned. If the user does not want the buzzer active, it may be turned off.

Following procedure describes the procedure for turning off the buzzer in 1_Phase Mode /3_Phase Mode.

1. Press Buzzer at the bottom.
2. Turn the RPG to change ON to OFF and press **ENTER**.

3_Phase LOCAL QUIT				1_Phase LOCAL QUIT			
OUTPUT SETTING				OUTPUT SETTING			
#1	Vac =	0.0V	F = 60.00Hz	Vac = 0.0V		F = 60.00Hz	
#2	Vac =	0.0V	F = 60.00Hz	Vac = 0.0V		F = 60.00Hz	
#3	Vac =	0.0V	F = 60.00Hz	Vac = 0.0V		F = 60.00Hz	
MEASUREMENT				MEASUREMENT			
#1	V =	0.00	Po = 0.0	V = 0.00	Po = 0.0		
	I =	0.000	PF = 0.000	I = 0.000	PF = 0.000		
#2	V =	0.00	Po = 0.0	Vac = 0.00	Vdc = 0.00		
	I =	0.000	PF = 0.000	Iac = 0.000	Idc = 0.000		
#3	V =	0.00	Po = 0.0	Vpk = 0.00	VA = 0.0		
	I =	0.000	PF = 0.000	Ipk = 0.000	CF = 0.000		
Σ	V ₁₂ =	0.00	V ₂₃ = 0.00				
	V ₃₁ =	0.00	Po = 0.0				
Output Relay	Buzzer	Date/Time	Remote Sense	Output Relay	Buzzer	Date/Time	Remote Sense
Depend.	Off		On	Depend.	Off		On
2014/12/17 17:25:30				2014/12/17 17:25:12			

Set the time and date of Regenerative Grid Simulator.

Date/Time: Year, Month, Day, Hour, Minute, Second.

Follow the procedure below to set the time and date in 1_Phase Mode /3_Phase Mode.

1. Press Date/Time at the bottom.
2. Select the item (Year/Month/Day/Hour/Minute/Second) to be set and press the button on the right.
3. Use the RPG to change the selected item and press **ENTER**.

3 Phase LOCAL QUIT						1 Phase LOCAL QUIT					
OUTPUT SETTING					Config	OUTPUT SETTING					Config
#1	Vac =	0.0V	F =	60.00Hz	Year	Vac = 0.0V F = 60.00Hz					Year
#2	Vac =	0.0V	F =	60.00Hz	2014						2014
#3	Vac =	0.0V	F =	60.00Hz	Month						Month
MEASUREMENT					12	MEASUREMENT					12
#1	V =	0.00	P ₀ =	0.0	Day	V =	0.00	P ₀ =	0.0	Day	
	I =	0.000	PF =	0.000	17	I =	0.000	PF =	0.000	17	
#2	V =	0.00	P ₀ =	0.0	Hour	Vac =	0.00	Vdc =	0.00	Hour	
	I =	0.000	PF =	0.000	17	Iac =	0.000	Idc =	0.000	17	
#3	V =	0.00	P ₀ =	0.0	Minute	Vpk =	0.00	VA =	0.0	Minute	
	I =	0.000	PF =	0.000	27	Ipk =	0.000	CF =	0.000	27	
Σ	V ₁₂ =	0.00	V ₂₃ =	0.00	Second						Second
	V ₃₁ =	0.00	P ₀ =	0.0	16						53
Output Relay Depend.	Buzzer On	Date/Time	Remote Sense On		2014/12/17 17:27:31	Output Relay Depend.	Buzzer On	Date/Time	Remote Sense On		2014/12/17 17:28:10

At last, it can enable the Remote Sense to monitor the load voltage and compensate automatically to make sure the voltage sends to load is the set voltage.

Remote Sense: on, off.

Follow the procedure below to enable the remote voltage sense in 1_Phase Mode /3_Phase Mode.

1. Press Remote Sense at the bottom.
2. Turn the RPG to change ON to OFF and press **ENTER**.

3 Phase LOCAL QUIT						3 Phase LOCAL QUIT					
OUTPUT SETTING					Config	OUTPUT SETTING					Config
#1	Vac =	0.0V	F =	60.00Hz	Others	#1	Vac =	0.0V	F =	60.00Hz	Others
#2	Vac =	0.0V	F =	60.00Hz	Calibration	#2	Vac =	0.0V	F =	60.00Hz	Calibration
#3	Vac =	0.0V	F =	60.00Hz		#3	Vac =	0.0V	F =	60.00Hz	
MEASUREMENT					System Information	MEASUREMENT					System Information
#1	V =	0.00	P ₀ =	0.0	Factory Default	#1	V =	0.00	P ₀ =	0.0	Factory Default
	I =	0.000	PF =	0.000		#1	I =	0.000	PF =	0.000	
#2	V =	0.00	P ₀ =	0.0	Master/Slave Function	#2	V =	0.00	P ₀ =	0.0	Master/Slave Function
	I =	0.000	PF =	0.000		#2	I =	0.000	PF =	0.000	
#3	V =	0.00	P ₀ =	0.0	More 2 of 2	#3	V =	0.00	P ₀ =	0.0	More 2 of 2
	I =	0.000	PF =	0.000		#3	I =	0.000	PF =	0.000	
Σ	V ₁₂ =	0.00	V ₂₃ =	0.00		Σ	V ₁₂ =	0.00	V ₂₃ =	0.00	
	V ₃₁ =	0.00	P ₀ =	0.0		Σ	V ₃₁ =	0.00	P ₀ =	0.0	
Output Relay Depend.	Buzzer On	Date/Time	Remote Sense Off		2014/12/17 17:29:08	Output Relay Depend.	Buzzer On	Date/Time	Remote Sense On		2014/12/17 17:29:57

3.4.7 Calibration

See the descriptions in Chapter 4 for the detailed calibration procedures.

3.4.8 System Information

Press MORE on the right in the CONFIG function (3_Phase Mode/1_Phase Mode) to go to next page. Press System Information on the right to see the system information of the Regenerative Grid Simulator.

3_Phase LOCAL QUIT					
UNIT DATA					Config
Model : 61860 SN:000002					Others
Display	Version :	01.00	Dec 17 2014		Calibration
Waveform	Version :	1.00	,1.00 ,1.00		System Information
Remote	Version :	1.00	,0.05#		Factory Default
Waveform HDL	Version :	1.00	,1.00 ,1.00		Master/Slave Function
GRID Firmware	Version :	1.00	,1.00 ,1.00		More 2 of 2
GRID HDL	Version :	1.00	,1.00 ,1.00		
LAN Firmware	Version :	1.00			
					2014/12/18 11:20:18

3.4.9 Factory Default

Press MORE on the right in the CONFIG function (3_Phase Mode/1_Phase Mode) to go to next page. Press Factory Default on the right and Yes at the bottom to return to the factory default.

3_Phase LOCAL QUIT					
FACTORY DEFAULT					Config
Recall Factory Default setting?					Others
					Calibration
					System Information
					Factory Default
					Master/Slave Function
					More 2 of 2
	Yes		No		2014/12/17 17:31:46

3.5 PHASE Function Key

Press **PHASE** function key in Figure 3-5 to go to the switch 3_Phase Mode/1_Phase Mode.

3.5.1 3_Phase Mode

The Regenerative Grid Simulator can be set to 3-phase AC power by pressing the **PHASE** function key to switch to 3_Phase Mode when it is required.

The procedure for setting the Regenerative Grid Simulator to 3-phase mode is described below.

1. Press **PHASE** function key.
2. Press Three 3_PHASE on the right.
3. Press Yes on the right to confirm the change.

? Phase LOCAL QUIT						? Phase LOCAL QUIT					
NUMBER OF OUTPUT PHASE SELECTION						NUMBER OF OUTPUT PHASE SELECTION					
The output is in Single Phase (1_Phase) mode now. Select a mode						Warning!					
						You want to change to Three Phase(3_Phase) mode.					
						It is necessary to check if the output is connected properly, otherwise the AC source and/or UUT might be damaged.					
						Press <Yes> to change. Press <No> to exit.					
2014/12/17 17:33:25						2014/12/17 17:34:04					

3.5.2 1_Phase Mode

When the 3-phase power of the Regenerative Grid Simulator is not enough to drive the load, the 3-phase output can be paralleled to one of the phases. Pressing the **PHASE** function key can change the Regenerative Grid Simulator setting from 3-phase to 1-phase.

The procedure for setting the Regenerative Grid Simulator to 1-phase mode is described below.

1. Press **PAHSE** function key.
2. Press Single 1_PHASE on the right.
3. Press Yes on the right to confirm the change.

? Phase 300V LOCAL QUIT						? Phase 300V LOCAL QUIT					
NUMBER OF OUTPUT PHASE SELECTION						NUMBER OF OUTPUT PHASE SELECTION					
The output is in Three Phase (3_Phase) mode now. Select a mode						Warning!					
						You want to change to Single Phase(1_Phase) mode.					
						It is necessary to check if the output is connected properly, otherwise the AC source and/or UUT might be damaged.					
						Press <Yes> to change. Press <No> to exit.					
2014/05/17 09:35:26						2014/05/17 09:39:13					

Notice

- When switching between 1-phase and 3-phase mode, the set output value will be reset to zero to avoid damaging the Unit Under Test (UUT).

3.6 CURSOR Function Key

Press **CURSOR** function key in Figure 3-5 to set the value of a single digit.

The RPG can be used to set the digit of hundred, decade, figure and 1st place after the decimal point for voltage or frequency to save time in inputting the values.

The procedure for setting the 1st place after the decimal point for output voltage Vac in 1_Phase Mode /3_Phase Mode is described below.

1. Move the cursor to “Vac =” command line.
2. Press **CURSOR** function key.
3. The cursor will shorten to one digit range.
4. Move the cursor to the 1st digit after decimal point and use the RPG to change the value.
5. Press **CURSOR** function key again to exit it.

3 Phase LOCAL QUIT						1 Phase LOCAL QUIT							
OUTPUT SETTING						OUTPUT SETTING							
#1	Vac =	000.	0V	F =	60.00Hz	Vac = 000.0V F = 60.00Hz							
#2	Vac =	0.0V	F =	60.00Hz									
#3	Vac =	0.0V	F =	60.00Hz									
MEASUREMENT						MEASUREMENT							
#1	V =	0.00	Po =	0.0	V = 0.00 Po = 0.0								
	I =	0.000	PF =	0.000	I = 0.000 PF = 0.000								
#2	V =	0.00	Po =	0.0	Vac = 0.00 Vdc = 0.00								
	I =	0.000	PF =	0.000	Iac = 0.000 Idc = 0.000								
#3	V =	0.00	Po =	0.0	Vpk = 0.00 VA = 0.0								
	I =	0.000	PF =	0.000	Ipk = 0.000 CF = 0.000								
Σ	V ₁₂ =	0.00	V ₂₃ =	0.00									
	V ₃₁ =	0.00	Po =	0.0									
Recall CH1	Recall CH2	Recall CH3	Recall CH4	Recall CH5	More 1 of 2	2014/12/17 17:38:07	Recall CH1	Recall CH2	Recall CH3	Recall CH4	Recall CH5	More 1 of 2	2014/12/17 17:38:43

3.7 LOCK Function Key

Press **LOCK** function key in Figure 3-5 to lock the function.

Press this key to lock all functions on the panel and making all keys invalid. Press **LOCK** for 3~3.5 seconds to unlock it.

3 Phase LOCAL QUIT						1 Phase LOCAL QUIT					
OUTPUT SETTING						OUTPUT SETTING					
#1	Vac =	0.0V	F =	60.00Hz	Vac = 0.0V F = 60.00Hz						
#2	Vac =	0.0V	F =	60.00Hz							
#3	Vac =	0.0V	F =	60.00Hz							
MEASUREMENT						MEASUREMENT					
#1	V =	0.00	Po =	0.0	V = 0.00 Po = 0.0						
	I =	0.000	PF =	0.000	I = 0.000 PF = 0.000						
#2	V =	0.00	Po =	0.0	Vac = 0.00 Vdc = 0.00						
	I =	0.000	PF =	0.000	Iac = 0.000 Idc = 0.000						
#3	V =	0.00	Po =	0.0	Vpk = 0.00 VA = 0.0						
	I =	0.000	PF =	0.000	Ipk = 0.000 CF = 0.000						
Σ	V ₁₂ =	0.00	V ₂₃ =	0.00							
	V ₃₁ =	0.00	Po =	0.0							
LOCK! Front key and Rotary are disabled Press <LOCK> for 3 seconds to enable them						LOCK! Front key and Rotary are disabled Press <LOCK> for 3 seconds to enable them					
2014/12/18 09:52:50						2014/12/18 09:53:31					

3.8 OUTPUT Function Key

Please refer to section 3.3.1 for the detail description of OUTPUT function key.

3.9 LOCAL/REMOTE Function Key

Press **LOCAL/REMOTE** function key in Figure 3-5 to switch to remote control.

When the Regenerative Grid Simulator is in REMOTE state and controlled by an external device, press this key to release the REMOTE state and return to LOCAL control.

3_Phase		REMOTE		QUIT		
OUTPUT SETTING						Main
#1	Vac =	0.0V	F =	60.00Hz		
#2	Vac =	0.0V	F =	60.00Hz		
#3	Vac =	0.0V	F =	60.00Hz		
MEASUREMENT						
#1	V =	0.00	Po =	0.0		
	I =	0.000	PF =	0.000		
#2	V =	0.00	Po =	0.0		
	I =	0.000	PF =	0.000		
#3	V =	0.00	Po =	0.0		
	I =	0.000	PF =	0.000		
Σ	V ₁₂ =	0.00	V ₂₃ =	0.00		
	V ₃₁ =	0.00	Po =	0.0		
						2014/12/18 09:59:03

3.10 SAVE/RECALL Function Key

The Regenerative Grid Simulator has two modes for users to save and recall the output setting or system information as described in section 3.10.1 and 3.10.2. Press **SAVE/RECALL** function key in Figure 3-5 to access the save and recall functions.

3.10.1 Save/Recall Output Setting

The Regenerative Grid Simulator has 10 channels for users to save the frequently used Vac, F and Vdc for recall. For example, enter the setting and save it to CH1 memory in MAIN PAGE (3_Phase Mode) (see 3.3.)

3 Phase		300V		LOCAL		QUIT	
OUTPUT SETTING							
#1	Vac =	0.0V	F =	60.00Hz	Save/Recall		
#2	Vac =	0.0V	F =	60.00Hz	Save Output Setting		
#3	Vac =	0.0V	F =	60.00Hz	Save System Data		
MEASUREMENT							
#1	V =	0.00	P _o =	0.0	Recall Output Setting		
#2	I =	0.000	PF =	0.000	Recall System Data		
#3	V =	0.00	P _o =	0.0			
	I =	0.000	PF =	0.000			
	V =	0.00	P _o =	0.0			
	I =	0.000	PF =	0.000			
	V ₁₂ =	0.00	V ₂₃ =	0.00			
	V ₃₁ =	0.00	P _o =	0.0			
2014/05/17 09:57:00							

3 Phase		300V		LOCAL		QUIT	
OUTPUT SETTING							
#1	Vac =	0.0V	F =	60.00Hz	Save/Recall		
#2	Vac =	0.0V	F =	60.00Hz	Save Output Setting		
#3	Vac =	0.0V	F =	60.00Hz	Save System Data		
CHANNEL DATA							
	Vac =	0.0V	F =	60.00Hz	Vdc =	0.0V	
1	Vac =	0.0V	F =	60.00Hz	Vdc =	0.0V	
	Vac =	0.0V	F =	60.00Hz	Vdc =	0.0V	
	Vac =	0.0V	F =	60.00Hz	Vdc =	0.0V	
2	Vac =	0.0V	F =	60.00Hz	Vdc =	0.0V	Recall Output Setting
	Vac =	0.0V	F =	60.00Hz	Vdc =	0.0V	
	Vac =	0.0V	F =	60.00Hz	Vdc =	0.0V	
3	Vac =	0.0V	F =	60.00Hz	Vdc =	0.0V	Recall System Data
	Vac =	0.0V	F =	60.00Hz	Vdc =	0.0V	
	Vac =	0.0V	F =	60.00Hz	Vdc =	0.0V	
4	Vac =	0.0V	F =	60.00Hz	Vdc =	0.0V	
	Vac =	0.0V	F =	60.00Hz	Vdc =	0.0V	
	Vac =	0.0V	F =	60.00Hz	Vdc =	0.0V	
Save to CH1	Save to CH2	Save to CH3	Save to CH4	More		2014/05/17 09:57:27	

3 Phase		300V		LOCAL		QUIT	
OUTPUT SETTING							
#1	Vac =	0.0V	F =	60.00Hz	Save/Recall		
#2	Vac =	0.0V	F =	60.00Hz	Save Output Setting		
#3	Vac =	0.0V	F =	60.00Hz	Save System Data		
CHANNEL DATA							
Save output setting to CH 1							
Recall Output Setting							
Recall System Data							
2014/05/17 09:58:12							

3 Phase		300V		LOCAL		QUIT	
OUTPUT SETTING							
#1	Vac =	0.0V	F =	60.00Hz	Save/Recall		
#2	Vac =	0.0V	F =	60.00Hz	Save Output Setting		
#3	Vac =	0.0V	F =	60.00Hz	Save System Data		
CHANNEL DATA							
	Vac =	0.0V	F =	60.00Hz	Vdc =	0.0V	
1	Vac =	0.0V	F =	60.00Hz	Vdc =	0.0V	
	Vac =	0.0V	F =	60.00Hz	Vdc =	0.0V	
	Vac =	0.0V	F =	60.00Hz	Vdc =	0.0V	
2	Vac =	0.0V	F =	60.00Hz	Vdc =	0.0V	Recall Output Setting
	Vac =	0.0V	F =	60.00Hz	Vdc =	0.0V	
	Vac =	0.0V	F =	60.00Hz	Vdc =	0.0V	
3	Vac =	0.0V	F =	60.00Hz	Vdc =	0.0V	Recall System Data
	Vac =	0.0V	F =	60.00Hz	Vdc =	0.0V	
	Vac =	0.0V	F =	60.00Hz	Vdc =	0.0V	
4	Vac =	0.0V	F =	60.00Hz	Vdc =	0.0V	
	Vac =	0.0V	F =	60.00Hz	Vdc =	0.0V	
	Vac =	0.0V	F =	60.00Hz	Vdc =	0.0V	
Recall CH1	Recall CH2	Recall CH3	Recall CH4	More		2014/05/17 09:58:48	

Notice

1. Only the save and recall settings are set in MAIN PAGE. Other parameters are ignored.
2. In different output/coupling modes (see 3.3.1.1) the missing settings will be adjusted to Vac=0V, F=60Hz, Vdc=0V automatically. For example, when executing save in DC output mode Vac=0V, F=60Hz, Vdc is the setting in MAIN PAGE.

3.10.2 Save/Recall System Data

The Regenerative Grid Simulator has 10 groups of memory for users to save and recall system data. System data contains all parameters in the function keys such as MAIN PAGE (see 3.3) and CONFIG (see 3.4). Press **SAVE/RECALL** in MAIN PAGE (3_Phase Mode) (see 3.3) and press the LCD at the bottom to save the system data as shown below.

3 Phase		300V		LOCAL		QUIT	
OUTPUT SETTING							
#1	Vac =	0.0V	F =	60.00Hz	Save/Recall		
#2	Vac =	0.0V	F =	60.00Hz	Save Output Setting		
#3	Vac =	0.0V	F =	60.00Hz	Save System Data		
MEASUREMENT							
#1	V =	0.00	P _o =	0.0	Recall Output Setting		
#2	I =	0.000	PF =	0.000	Recall System Data		
#3	V =	0.00	P _o =	0.0			
	I =	0.000	PF =	0.000			
	V ₁₂ =	0.00	V ₂₃ =	0.00			
	V ₃₁ =	0.00	P _o =	0.0			
2014/05/17 10:00:30							

3 Phase		300V		LOCAL		QUIT	
OUTPUT SETTING							
#1	Vac =	0.0V	F =	60.00Hz	Save/Recall		
#2	Vac =	0.0V	F =	60.00Hz	Save Output Setting		
#3	Vac =	0.0V	F =	60.00Hz	Save System Data		
MEASUREMENT							
#1	V =	0.00	P _o =	0.0	Recall Output Setting		
#2	I =	0.000	PF =	0.000	Recall System Data		
#3	V =	0.00	P _o =	0.0			
	I =	0.000	PF =	0.000			
	V ₁₂ =	0.00	V ₂₃ =	0.00			
	V ₃₁ =	0.00	P _o =	0.0			
Save to GROUP1	Save to GROUP2	Save to GROUP3	Save to GROUP4	Save to GROUP5	More	2014/05/17 10:00:54	

3 Phase		300V		LOCAL		QUIT	
OUTPUT SETTING							
#1	Vac =	0.0V	F =	60.00Hz	Save/Recall		
#2	Vac =	0.0V	F =	60.00Hz	Save Output Setting		
#3	Vac =	0.0V	F =	60.00Hz	Save System Data		
CHANNEL DATA							
Save system data to GROUP 1							
Recall Output Setting							
Recall System Data							
2014/05/17 10:01:18							

3 Phase		300V		LOCAL		QUIT	
OUTPUT SETTING							
#1	Vac =	0.0V	F =	60.00Hz	Save/Recall		
#2	Vac =	0.0V	F =	60.00Hz	Save Output Setting		
#3	Vac =	0.0V	F =	60.00Hz	Save System Data		
MEASUREMENT							
#1	V =	0.00	P _o =	0.0	Recall Output Setting		
#2	I =	0.000	PF =	0.000	Recall System Data		
#3	V =	0.00	P _o =	0.0			
	I =	0.000	PF =	0.000			
	V ₁₂ =	0.00	V ₂₃ =	0.00			
	V ₃₁ =	0.00	P _o =	0.0			
Recall GROUP1	Recall GROUP2	Recall GROUP3	Recall GROUP4	Recall GROUP5	More	2014/05/17 10:01:48	

Notice

The Regenerative Grid Simulator has 11 groups of memory: GROUP 0, GROUP1~10. GROUP 0 will save the power-on default. The data saved in GROUP 0 will be recalled automatically and loaded when the Regenerative Grid Simulator powers on again. As to the data saved in GROUP 1~10 memory groups, they need to be called manually for loading.

3.11 Protection

The Regenerative Grid Simulator has both software and hardware protection. When protection occurs the Regenerative Grid Simulator will stop the output and disconnect the output relay. The display shows that the source is in protection mode. To normal output after the Recovery protection is triggered, please address any issues and press **ENTER** to release protection for normal operation. To normal output after the Latch protection is triggered, remove the error load and restart  to release protection for normal operation.

The table below lists the output protection:

Message	Protection	Possible Cause	Troubleshooting
SYS_OCP(1/2/3)	It occurs when the output current exceeds the system set current limit. (Recovery)	1. The UUT impedance is too low. 2. Temporary short circuit.	1. Remove the UUT and make sure the protection value is correctly set.
(ϕ 1/2/3) DA_OCP	It occurs when the transient output current exceeds the module current limit or current specification. (Latch)	3. The RCD load impedance is too small. 4. The UUT capacitive load is too big.	2. Remove the UUT and confirm its correctness. 3. Add a current limit resistor. 4. Set the voltage slew rate.
SYS_OPP(1/2/3)	It occurs when the output power exceeds the system set power limit. (Recovery)	1. The UUT impedance is too low. 2. Temporary short circuit.	1. Remove the UUT and make sure the protection value is correctly set.
(ϕ 1/2/3)DA_OPP	It occurs when the transient output power exceeds the module power limit or power specification. (Latch)		2. Remove the UUT and confirm its correctness.
SYS_OVP(1/2/3)	It occurs when the output voltage exceeds the system set voltage limit. (Recovery)	1. The external source is too large. 2. The external inductive load is open.	1. Make sure the external circuit is correct. 2. Check if the circuit is short circuited.
(ϕ 1/2/3)DA_OVP	It occurs when the transient output voltage exceeds the module voltage limit or voltage specification. (Latch)	3. The UUT capacitive load is too big.	3. Confirm the external circuit characteristics.
(ϕ 1/2/3)DA_SHORT	It occurs when the output is short circuited. (Latch)	1. The UUT impedance is too low. 2. Temporary short circuit.	1. Remove the UUT and make sure the protection value is correctly set. 2. Remove the UUT and confirm its correctness.
(ϕ 1/2/3)DA_SENSE_FAULT	It occurs when the remote voltage sense is enabled but the signal cable is disconnected or error. (Latch)	1. The Remote sense wire is disconnected or connected wrong. 2. The remote	1. Confirm the wiring connection of Remote sense 2. Shorten the distance between UUT and remove

		connection impedance is too big. 3. The output relay is failure.	the impedance. 3. Change the broken output relay.
(ϕ 1/2/3)DA_DST_PROT_F	DC/AC power module internal parts transient over rated protection. (Recovery)	1. The output voltage waveform and frequency set by the user is over the rated DC/AC power module internal parts.	1. Reset the output voltage waveform and frequency.
(ϕ 1/2/3)DA_DST_PROT_S	DC/AC power module internal parts steady state over rated protection. (Recovery)	2. The DC/AC module measurement circuit is having error. 3. The DC/AC module digital circuit is having error. 4. The digital module is having error.	2. Check and replace the DC/AC module board that is having protection phase. 3. Check and replace the DC/AC digital module board that is having protection phase. 4. Check and replace the digital module board.
Remote - Inhibit	It occurs when remote is inhibited.		
SYS_UVP(1/2/3)(ACL)	It occurs when the UUT voltage is lower than the set voltage limit. (Recovery)	The external UUT output is short-circuited.	1. Remove the UUT and check its circuit characteristics. 2. Check if the circuit is short-circuited. 3. Check the external circuit characteristics.
(ϕ 1/2/3)DA_UVP(ACL)	It occurs when the UUT transient output voltage is lower than the operating voltage limit. (Latch)		

The table below lists the module protection:

Message	Protection	Possible Cause	Troubleshooting
FAN_FAIL_TR	It occurs when the auxiliary power module fan is malfunction. (Latch)	1. The fan is blocked due foreign object or dust.	1. Check the fan on the module having protection and clear the foreign
(ϕ 1/2/3)AD_FAN_FAIL	It occurs when the	2. The fan is not	

	AC/DC power module fan is malfunction. (Latch)	connected. 3. The fan is broken or invalid.	object. 2. Check the connection of fan on the module having protection.
(φ1/2/3)DA_FAN_FAIL	It occurs when the DC/AC power module fan is malfunction. (Latch)	4. The fan circuit is malfunction.	3. Replace the broken or invalid fan. 4. Replace the fan circuit board.
(φ1/2/3)AD_DUST	It occurs when the AC/DC module is dusty. (Latch)	The AC/DC module has accumulated dust or foreign object.	Check the AC/DC module of each phase for dust and clean it.
(φ1/2/3)DA_DUST	It occurs when the DC/AC module is dusty. (Latch)	DC/AC module has accumulated dust or foreign object.	Check the DC/AC module of each phase for dust and clean it.
OTP_TR	It occurs when the auxiliary power module internal temperature is too high. (Latch)	1. The operating environment temperature is over.	1. Solve the environment overheat problem.
(φ1/2/3)AD_OTP	It occurs when the AC/DC power module internal temperature is too high. (Latch)	2. The power IGBT module is having error.	2. Check the error IGBT module and replace it.
(φ1/2/3)DA_OTP	It occurs when the DC/AC power module internal temperature is too high. (Latch)	3. The detection circuit is having error.	3. Check the error fan circuit board with sense wire and replace them.
(φ1/2/3)AD_OVP_LINE_RS_F (φ1/2/3)AD_OVP_LINE_ST_F (φ1/2/3)AD_OVP_LINE_TR_F	It occurs when the circuit transient input voltage is higher than the spec. (Latch)	1. Input power error.	1. Check if the input power meets the rated voltage.
(φ1/2/3)AD_OVP_LINE_RS_S (φ1/2/3)AD_OVP_LINE_ST_S (φ1/2/3)AD_OVP_LINE_TR_S	It occurs when the circuit steady input voltage is higher than the spec. (Latch)	2. The AC/DC module measurement circuit is having error.	2. Check and replace the protected AC/DC module board.
(φ1/2/3)AD_UVP_LINE_RS_F (φ1/2/3)AD_UVP_LINE_ST_F (φ1/2/3)AD_UVP_LINE_TR_F	It occurs when the circuit transient input voltage is lower than the spec. (Latch)	1. Input power is having error.	1. Check if the input power meets the rated voltage.
(φ1/2/3)AD_UVP_LINE_RS_S (φ1/2/3)AD_UVP_LINE_ST_S (φ1/2/3)AD_UVP_LINE_TR_S	It occurs when the circuit steady input voltage is lower	2. The AC/DC module input Fuse is broken. 3. The AC/DC module measurement	2. Measure the AC/DC module input fuse and replace it.

	than the spec. (Latch)	circuit is having error.	3. Check and replace the protected AC/DC module board.
(ϕ 1/2/3)AD_UNBALANCE_LINE	It occurs when the circuit input is unbalanced or open phase. (Latch)	<ol style="list-style-type: none"> 1. The input power is connected wrong. (10% line voltage difference) 2. The input power is disconnected (open phase.) 3. The AC/DC module fuse is broken. 4. The AC/DC module measurement circuit is having error. 	<ol style="list-style-type: none"> 1. Check if the input power meets the rated voltage. 2. Measure the AC/DC module input fuse and replace it. 3. Check and replace the protected AC/DC module board.
FREQ_LINE_ERR(ϕ 1/2/3)	It occurs when circuit input frequency is over the spec. (Latch)	The Mains frequency is incorrect.	Check the Mains frequency. (47Hz-63Hz)
(ϕ 1/2/3)AD_OCP_LINE_R_F (ϕ 1/2/3)AD_OCP_LINE_S_F (ϕ 1/2/3)AD_OCP_LINE_T_F	It occurs when circuit transient input current is over the limit. (Latch)	<ol style="list-style-type: none"> 1. The output transient power is too high. (The input current is over 135Arms.) 2. The AC/DC module measurement circuit is having error. 	<ol style="list-style-type: none"> 1. Remove the UUT and check if the operation is correct. 2. Check and replace the protected AC/DC module board.
(ϕ 1/2/3)AD_OCP_LINE_R_S (ϕ 1/2/3)AD_OCP_LINE_S_S (ϕ 1/2/3)AD_OCP_LINE_T_S	It occurs when the circuit steady input current is over the limit (Latch)		
(ϕ 1/2/3)AD_OPP_LINE_R_F (ϕ 1/2/3)AD_OPP_LINE_S_F (ϕ 1/2/3)AD_OPP_LINE_T_F	It occurs when the circuit transient input is over power.(Latch)	<ol style="list-style-type: none"> 1. The output transient power is too high. (The input power is over 84kW.) 2. The AC/DC module measurement circuit is having error. 	<ol style="list-style-type: none"> 1. Remove the UUT and check if the operation is correct. 2. Check and replace the protected AC/DC module board.
(ϕ 1/2/3)AD_OPP_LINE_R_S (ϕ 1/2/3)AD_OPP_LINE_S_S (ϕ 1/2/3)AD_OPP_LINE_T_S	It occurs when the circuit steady input is over power. (Latch)		
(ϕ 1/2/3)AD_OVP_VDC_F	It occurs when the power module internal DC BUS transient voltage is higher than the spec. (Latch)	<ol style="list-style-type: none"> 1. The output transient power is too high. (The protected phase VDC is higher than 700V.) (Regen mode) 2. The AC/DC 	<ol style="list-style-type: none"> 1. Remove the UUT and check if the operation is correct. 2. Check and replace the protected AC/DC module
(ϕ 1/2/3)AD_OVP_VDC_S	It occurs when the power module		

	internal DC BUS steady voltage is higher than the spec. (Latch)	module measurement circuit is having error.	board.
(ϕ 1/2/3)AD_UVP_VDC_F	It occurs when the power module internal DC BUS transient voltage is lower than the spec. (Latch)	1. The output transient power is too high. (The protected phase VDC is lower than 600V) (Source mode)	1. Remove the UUT and check if the operation is correct.
(ϕ 1/2/3)AD_UVP_VDC_S	It occurs when the power module internal DC BUS steady voltage is lower than the spec. (Latch)	2. The AC/DC module measurement circuit is having error. 3. AC/DC module relay driver signal is incorrect or the relay is broken. 4. The AC/DC module PWM driver signal is incorrect. 5. The AC/DC power module is abnormal or broken.	2. Check and replace the protected AC/DC module board. 3. Check and replace the protected AC/DC module board. 4. Check and replace the protected AC/DC power module board. 5. Check and replace the protected AC/DC power module board.
(ϕ 1/2/3)AD_OCP_IDC_F	It occurs when the power module internal DC BUS transient state is over current. (Latch)	1. The output transient power is too high. (The protected phase IDC is higher than 38Arms) (Source /Regen mode)	1. Remove the UUT and check if the operation is correct.
(ϕ 1/2/3)AD_OCP_IDC_S	It occurs when the power module internal DC BUS steady state is over current. (Latch)	2. The AC/DC module measurement circuit is having error. 3. The AC/DC power module is abnormal or broken. 4. The DC/AC power module is abnormal or broken.	2. Check and replace the protected AC/DC module board. 3. Check and replace the protected AC/DC power module board. 4. Check and replace the protected DC/AC power module board.
(ϕ 1/2/3)AD_OPP_PDC_F	It occurs when the power module internal DC BUS	1. The output transient power is too high. (The	1. Remove the UUT and check if the operation

	transient state is over power. (Latch)	protected phase PDC is higher than 26.25kW.) (Source/ Regen mode)	is correct.
(φ1/2/3)AD_OPP_PDC_S	It occurs when the power module internal DC BUS steady state is over power. (Latch)	<ol style="list-style-type: none"> 2. The AC/DC module measurement circuit is having error. 3. The AC/DC power module is abnormal or broken. 4. The DC/AC power module is abnormal or broken. 	<ol style="list-style-type: none"> 2. Check and replace the protected AC/DC module board. 3. Check and replace the protected AC/DC power module board. 4. Check and replace the protected DC/AC power module board.
SYS SELF_AD_1 SYS SELF_AD_2 SYS SELF_AD_3	It occurs when the auxiliary power of AC/DC power module is running self detect. (Latch)	<ol style="list-style-type: none"> 1. The AC/DC module auxiliary power is having error. 2. The AC/DC module measurement circuit is having error. 3. The digital module is having error. 	<ol style="list-style-type: none"> 1. Check and replace the AC/DC module auxiliary power board of protected phase. 2. Check and replace the AC/DC module board of protected phase. 3. Check and replace the digital module board.
SYS SELF_DA_1 SYS SELF_DA_2 SYS SELF_DA_3	It occurs when the auxiliary power of DC/AC power module is running self detect. (Latch)	<ol style="list-style-type: none"> 1. The DC/AC module auxiliary power is having error. 2. The AC/DC module measurement circuit is having error. 3. The digital module is having error. 	<ol style="list-style-type: none"> 1. Check and replace the DC/AC module auxiliary power board of protected phase. 2. Check and replace the DC/AC module board of protected phase. 3. Check and replace the digital module board.
SYS SELF_CS	It occurs when the	1. The digital	1. Check and

	auxiliary power of digital module is running self detect. (Latch)	<ul style="list-style-type: none"> 1. module auxiliary power is having error. 2. The digital module measurement circuit is having error. 3. The digital module is having error. 	<ul style="list-style-type: none"> 1. replace the digital module board. 2. Check and replace the digital module board. 3. Check and replace the digital module board.
SYS SELF_E	It occurs when the Interface and panel auxiliary power is running self detect. (Latch)	<ul style="list-style-type: none"> 1. The auxiliary power of digital interface module is having error. 2. The measurement circuit of digital interface module is having error. 3. The digital module is having error. 	<ul style="list-style-type: none"> 1. Check and replace the digital interface module board. 2. Check and replace the digital interface module board. 3. Check and replace the digital module board.
(φ1/2/3)AD_PWM_FAULT (1/2/3)	It occurs when the AC/DC power module driving signal is having error. (Latch)	<ul style="list-style-type: none"> 1. The driving signal is having error. (The power element is short circuited.) 2. The AC/DC module measurement circuit is having error. 3. The DC/AC module digital circuit is having error. 	<ul style="list-style-type: none"> 1. Check and replace the power module board of protected phase. 2. Check and replace the AC/DC module digital board of protected phase. 3. Check and replace the DC/AC module digital board of protected phase.
(φ1/2/3)DA_PWM(1/2)_FAULT	It occurs when the DC/AC power module driving signal is having error. (Latch)	<ul style="list-style-type: none"> 1. The driving signal is having error. (The power element is short circuited.) 2. The AC/DC module measurement circuit is having error. 3. The DC/AC module digital circuit is having error. 	<ul style="list-style-type: none"> 1. Check and replace the power module board of protected phase. 2. Check and replace the AC/DC module digital board of protected phase. 3. Check and replace the DC/AC module digital board of protected phase.
SYS SELF_TEST_NG_1 SYS SELF_TEST_NG_2 SYS SELF_TEST_NG_3	It occurs when the self-test of DC/AC power module output voltage is no good. (Recovery)	<ul style="list-style-type: none"> 1. The DC/AC module voltage calibration of protected phase is having error. 2. DC/AC module measurement circuit is having error. 3. The DC/AC module digital circuit is having 	<ul style="list-style-type: none"> 1. Execute voltage calibration again. 2. Check and replace the DC/AC module board of protected phase. 3. Check and replace the DC/AC module

		error. 4. The digital module is having error.	digital board of protected phase. 4. Check and replace the digital module board.
SYS_INT_OFF	It occurs when the circuit of auxiliary power module or digital module is having error. (Latch)	1. The auxiliary power (VD) is having error. 2. The digital module protection circuit is having error.	1. Check and replace the auxiliary power module. 2. Check and replace the digital module.
SYS_INT_AUX_OUT	It occurs when the auxiliary power module is having error. (Latch)	1. The auxiliary power (VP) is having error. 2. The auxiliary power protective circuit is having error.	Check and replace the auxiliary power module.
SYS_SHUTDOWN	It occurs when paralleling the Master or Slave units. (Latch)	1. The Mains is having error when paralleling the Master or Slave. 2. The auxiliary power module is having error when paralleling the Master or Slave. 3. The cables fell off when paralleling the Master or Slave.	1. Check if the Mains is having error when paralleling the Master or Slave. 2. Check or replace the auxiliary power module. 3. Check if the cables are connected firmly when paralleling the Master or Slave.

 **Notice**

- The protection message is marked _F(FAST) and _S(SLOW) by transient and steady state.
- The protection point varies by the measurement error, thus it may act before reaching the protection point set.

4. Calibration

4.1 Introduction

The Regenerative Grid Simulator has built in simple procedures for the user to operate for calibrating the output and measuring the accuracy without opening the case. When executing the calibration procedure, the voltmeter, ammeter, appropriate load and +10Vdc power supply are required. See Figure 4-1 for the connection of these instruments. The calibration items contain output voltage, output current and external reference voltage. However, it does not need to calibrate all of the three items at the same time. If desired, it can select one of them for calibration.

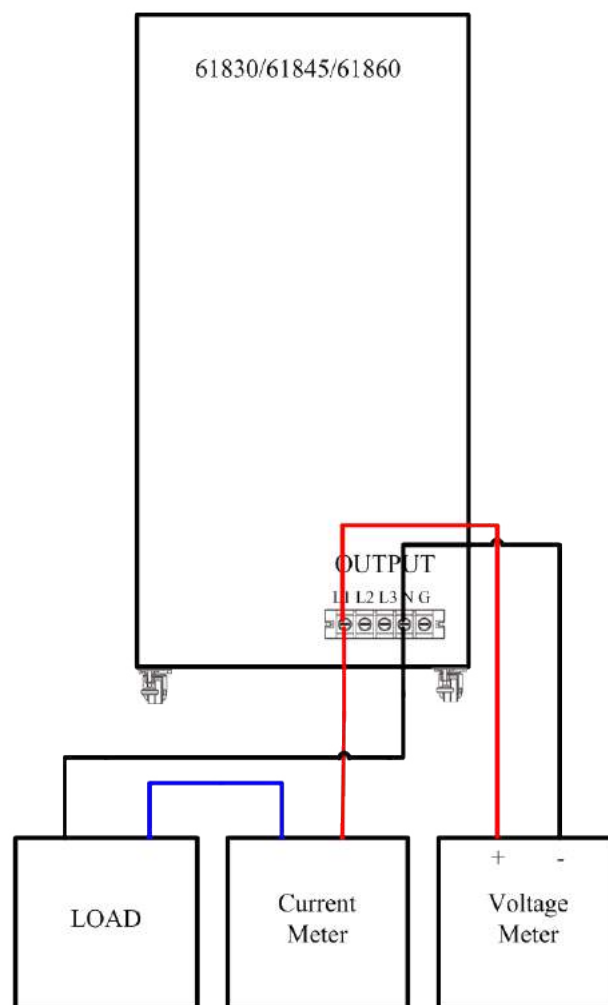

Figure 4-1

Notice

1. For the environment temperature of 25°C, it is required to warm up for 20 minutes before calibration so that the Regenerative Grid Simulator can reach the normal working temperature and make sure the calibrated values are correct.
2. The Voltage Meter cable ensures remote sense also connects to terminal.

4.2 Manual Calibration Function

Select "Calibration" in the CONFIG function (3_Phase Mode/1_Phase Mode) to input the calibration procedure. For safety reason, the user is required to enter the password to show the calibration items. The password is listed in this manual to ensure the user has read the manual before performing calibration.

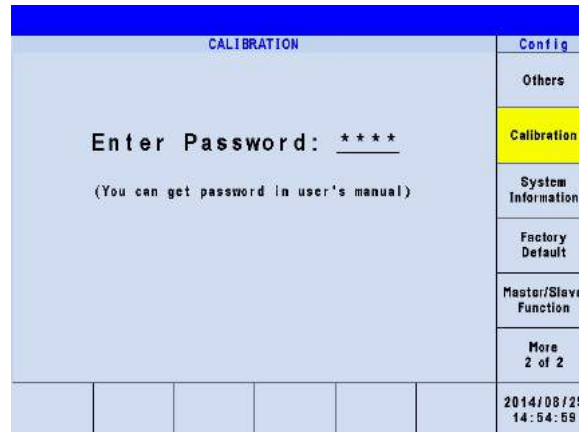

Notice

1. The password for entering the calibration procedure is "3621 ". Input it and press **ENTER** to confirm it.
2. Before calibrating the Regenerative Grid Simulator, the user should read the procedure clearly. Otherwise, the memory data could be lost due to improper operation.

The screen is displayed as below after the correct password is entered. The LCD shows that the calibration can only be performed in 3_Phase mode and it is prohibited to switch to 1_Phase mode. Press **ENTER** to continue the calibration procedure.

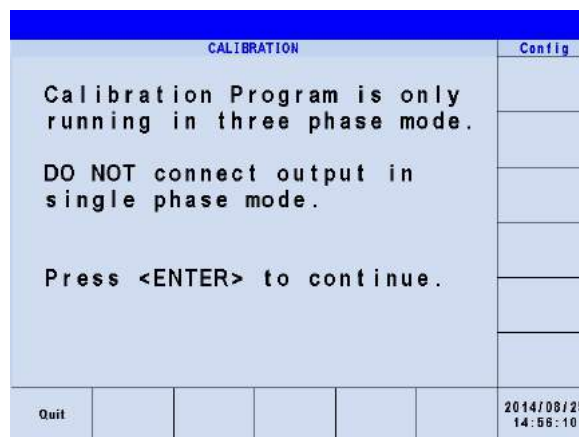

The user can choose to calibrate the voltage, current and external reference voltage.

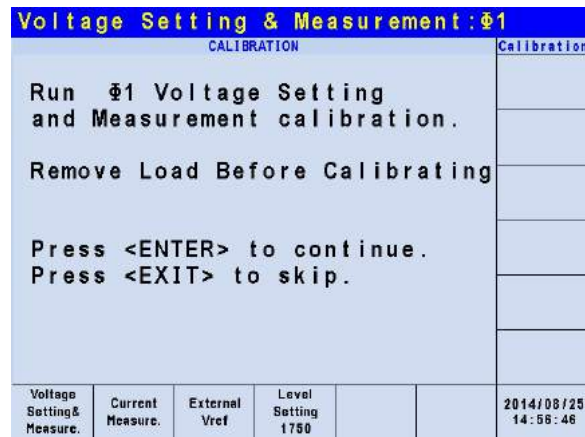

Voltage setting & Measure: It calibrates the output voltage and the accuracy of voltage measurement.

Current Measure: It calibrates accuracy of current measurement.

External Vref.: It calibrates the external Vref.

Level Setting: It adjusts the response speed.

4.2.1 Calibrating Output Voltage and Voltage Measurement

After entered the password, the CALIBRATION CHOICES are shown on the screen as described in section 4.2. Press Voltage setting & Measure to output voltage and execute the measurement calibration.

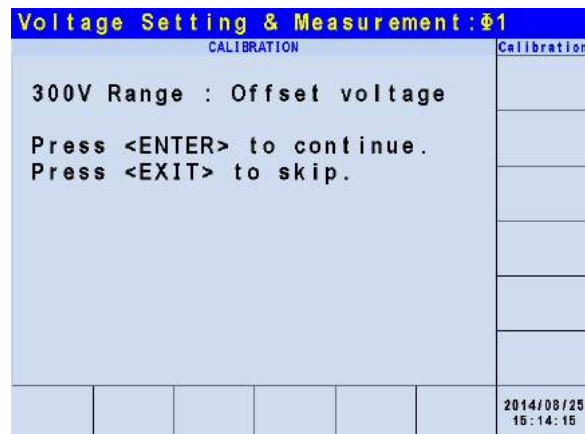

In measurement calibration, it will ask the user if performing Offset voltage calibration for 300V range. Press **ENTER** to continue the Offset voltage calibration. Press **EXIT** to skip the Offset voltage calibrating and enter into the 300V Range Setting & Meas. procedure.

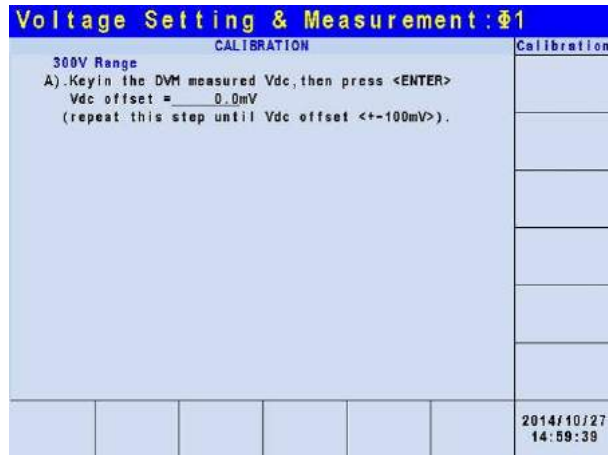

In the calibration procedure step A for 300V Range (Offset voltage), the user should use the DVM to measure the DC output voltage of Regenerative Grid Simulator in the unit of mV and then key in the value on the LCD. Monitor the DVM readings and enter the DC output voltage repeatedly till the DC output is lower than ± 100 mV.

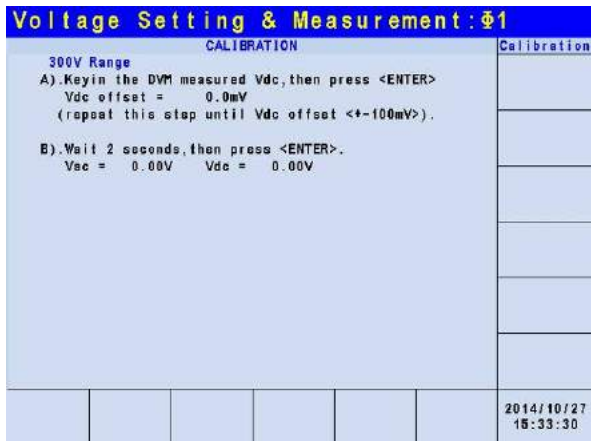
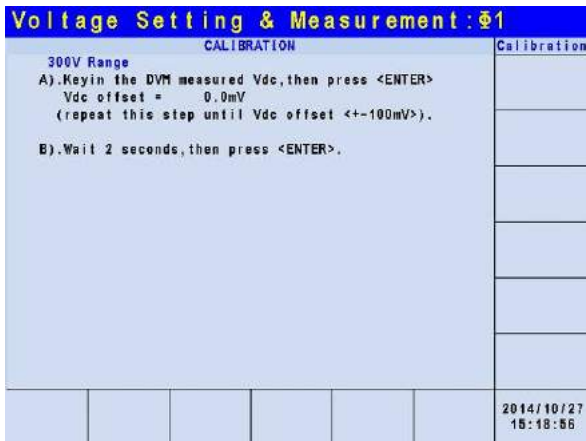

In step B, the LCD shows the differences of Vac and Vdc measured by the Regenerative Grid Simulator that are generated internally. Wait for 2 seconds and press **ENTER**, the LCD will show the voltage offset Vac and Vdc calculated by the Regenerative Grid Simulator

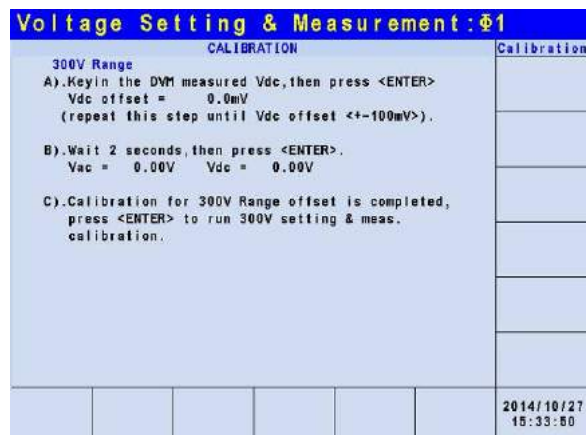

In step C, the LCD shows the calibration for 300V Range offset is completed. Press **EXIT** to enter into the saving screen as shown below or press **ENTER** to continue the 300V setting

and measurement calibration.

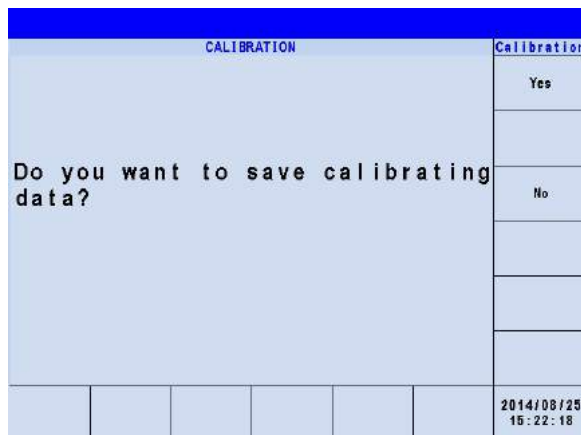

Press **EXIT** in step C and the LCD will show for saving. Press Yes on the right to save the calibration results.

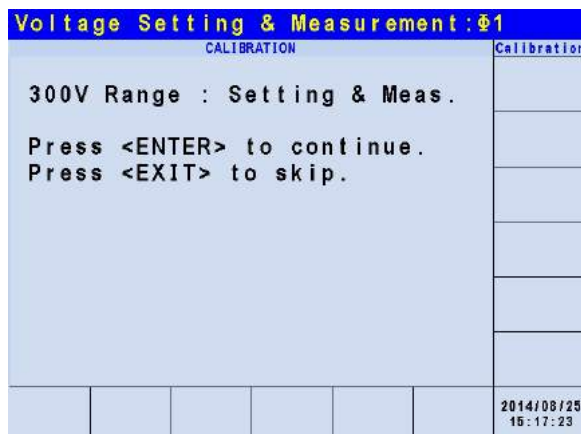

When the 300V Range (Offset voltage) calibration is done, the LCD will ask the user if executing the 300V Range Setting & Meas. Press **ENTER** to continue the setting and measurement calibration. Press **EXIT** to skip the Setting & Meas. to enter into the Calibration main screen.

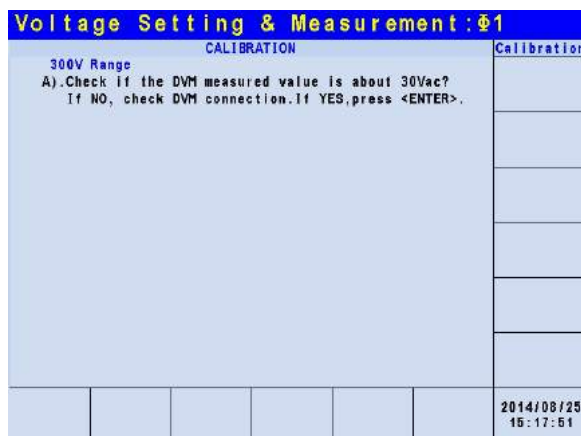

In the calibration procedure step A for 300V Range Setting & Measurement, the user should remove the load. Check the digital DVM measured output AC voltage for about 30Vac. This

is simply to confirm the connection and then press **ENTER**.

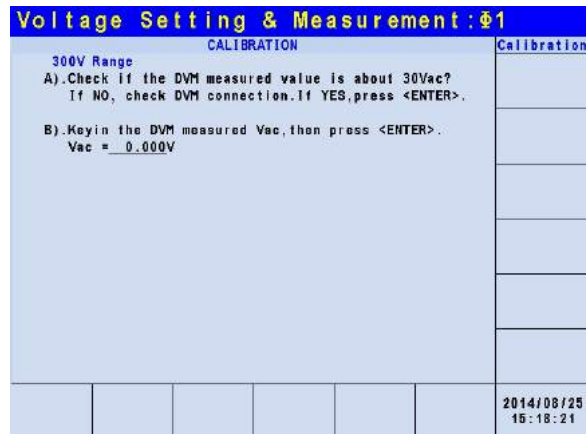

In step B, check the digital DVM measured output voltage for about 240VAC. Enter the digital DVM measured value and press **ENTER**.

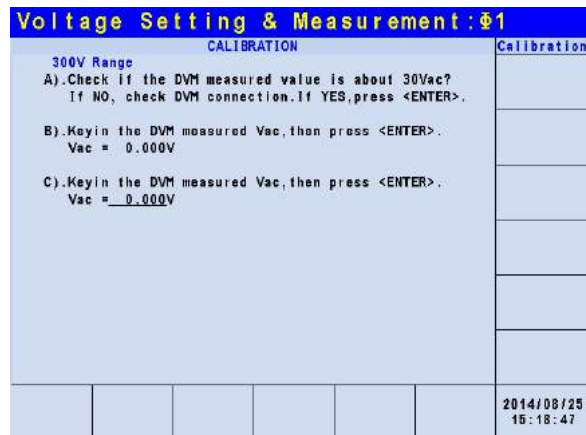

In step C, check the digital DVM measured output voltage for about 300VAC. Enter the digital DVM measured value and press **ENTER**.

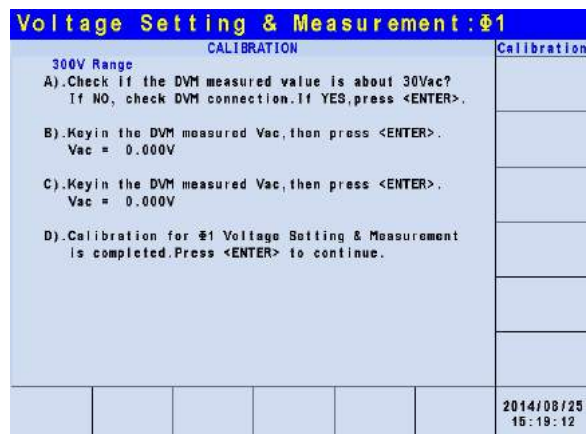

In step D, the LCD shows the calibration for 300V Range Setting & Meas. is completed. Press **EXIT** to enter into the saving screen as shown below or press **ENTER** to continue other voltage calibration.

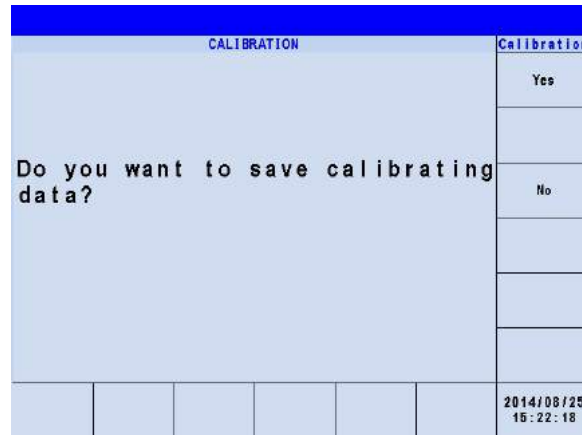

Press **EXIT** in step D and the LCD will show for saving. Press Yes on the right to save the calibration results.

Notice

1. In the last step, the user can press **ENTER** to continue calibrating the 2nd phase or the 3rd phase.
2. In the previous screen, if **EXIT** is pressed but the results are not saved, the calibrated values will remain till the Regenerative Grid Simulator is powered off.

4.2.2 Calibrating Current Measurement

After entered the password, the CALIBRATION CHOICES are shown on the screen as described in section 4.2. Press Current Measure to calibrate the current measurement.

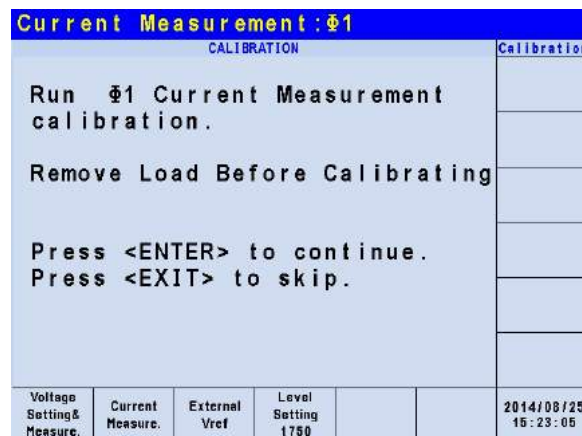

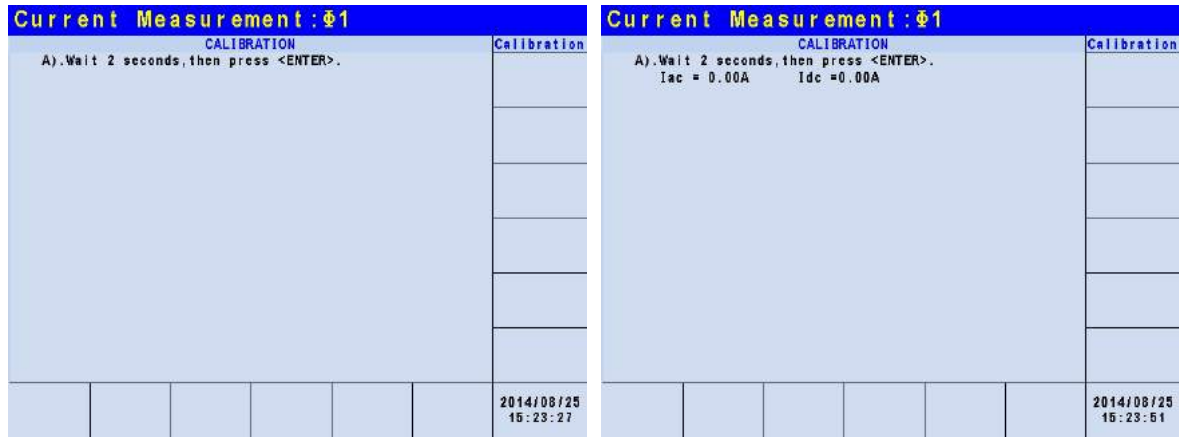

In the Current Measure. ACCURACY CALI. step A, the LCD shows the differences of Iac and Idc measured by the Regenerative Grid Simulator that are generated internally. Wait for 2 seconds and press **ENTER**, the Iac = 0.00A and Idc = 0.00A.

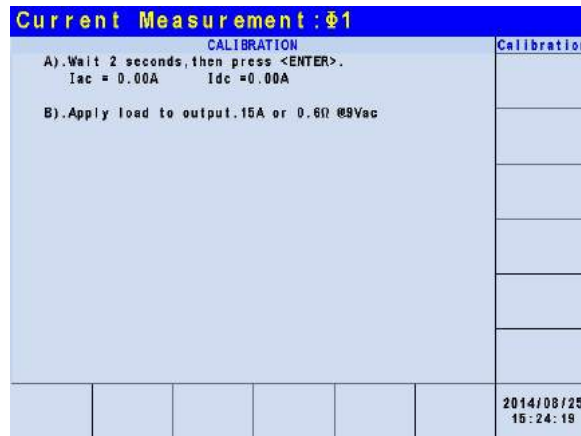

In step B, adjust the load to 0.6Ω for output and press **ENTER**. The Regenerative Grid Simulator will output 9Vac.

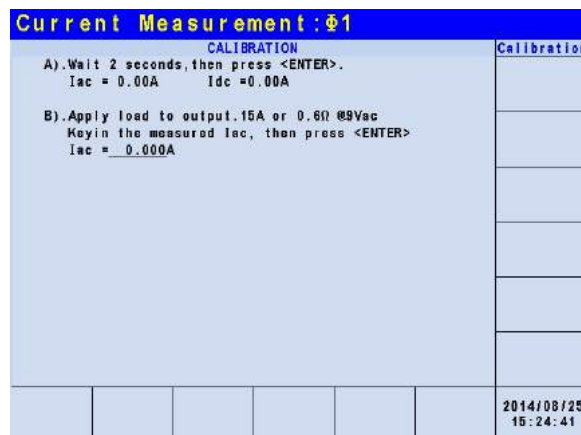

Use the ammeter (or power analyzer) to measure the output current. Input the measured value and press **ENTER**.

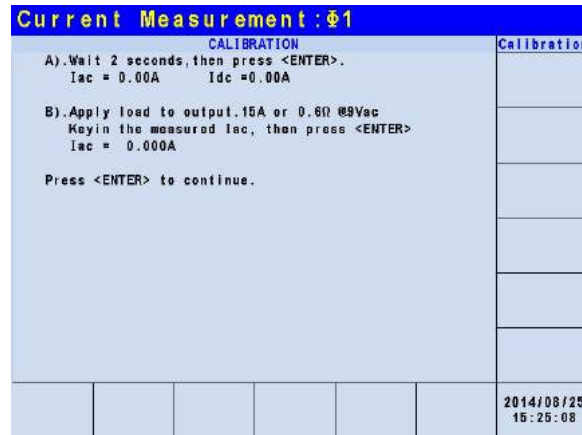

Press **ENTER** to continue the calibration procedure and disconnect the load now.

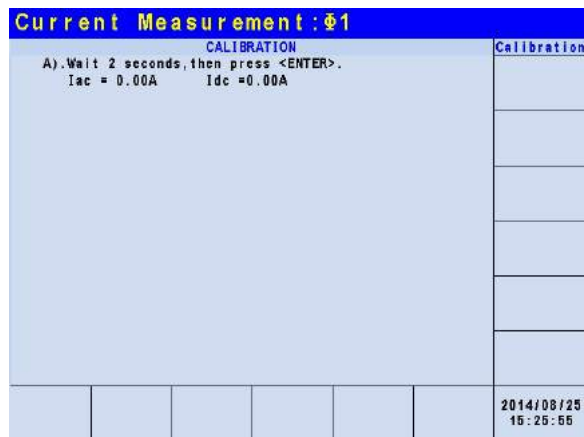
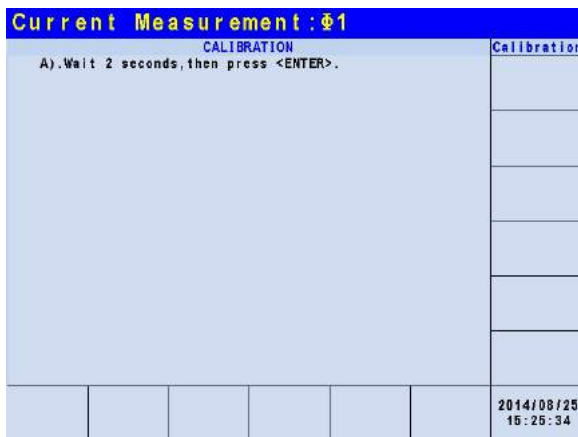

In step A, the LCD shows the differences of Iac and Idc measured by the Regenerative Grid Simulator that are generated internally. Wait for 2 seconds and press **ENTER**, the Iac = 0.00A and Idc = 0.00A.

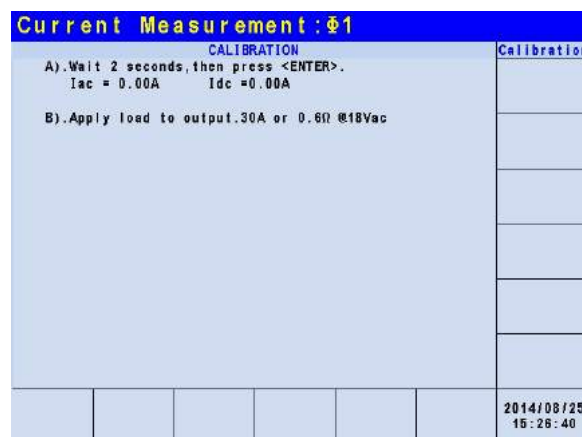

In step B, adjust the load to 0.6Ω for output and press **ENTER**. The Regenerative Grid Simulator will output 18Vac ◦

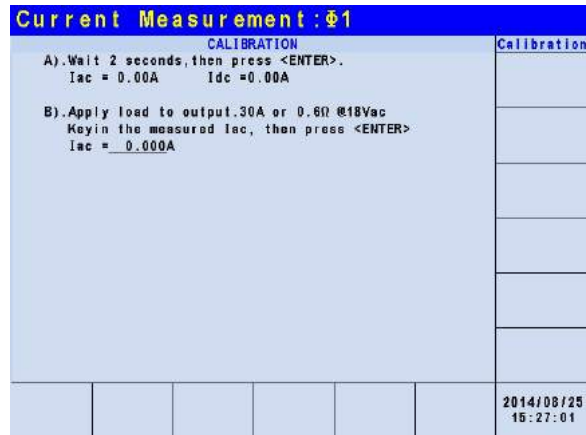

Use the ammeter (or power analyzer) to measure the output current. Input the measured value and press **ENTER**.

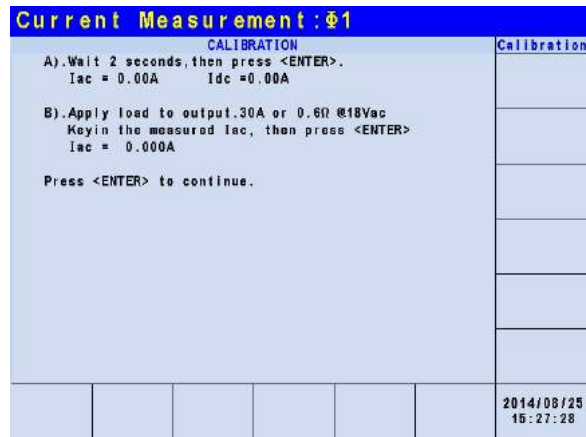

Press **ENTER** to continue the calibration procedure and disconnect the load now.

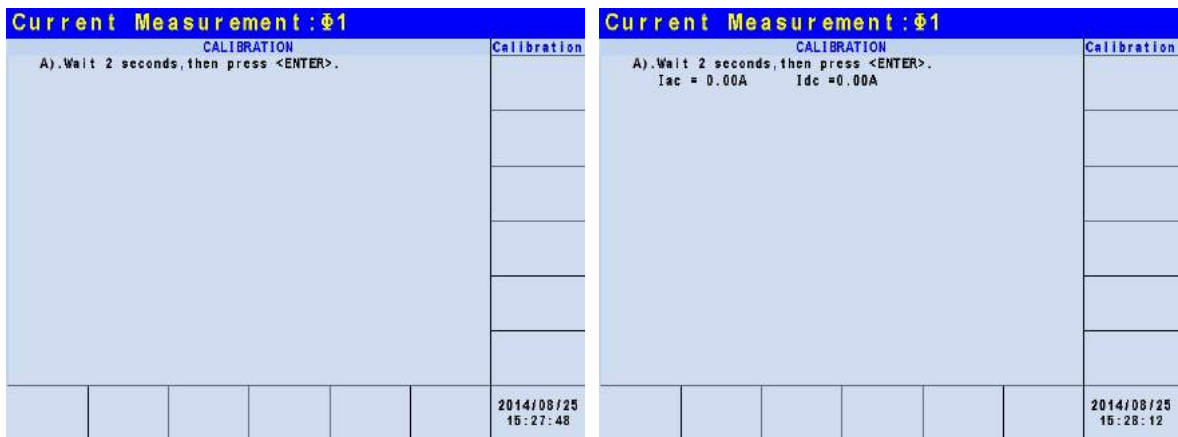

In step A, the LCD shows the differences of Iac and Idc measured by the Regenerative Grid Simulator that are generated internally. Wait for 2 seconds and press **ENTER**, the Iac = 0.00A and Idc = 0.00A.

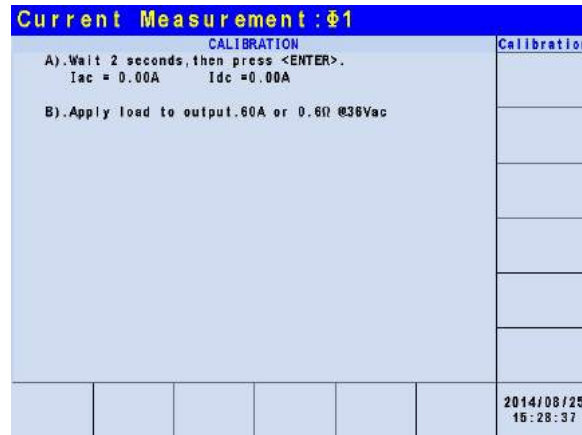

In step B, adjust the load to 0.62Ω for output and press **ENTER**. The Regenerative Grid Simulator will output 36Vac ◦



Notice

When the Regenerative Grid Simulator is model 61830, the simulated power output will be 27Vac.

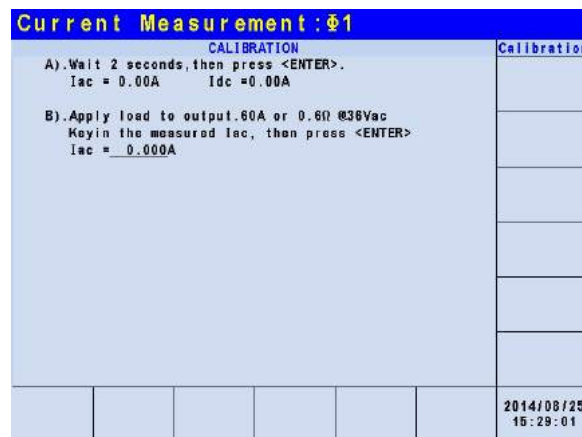

Use the ammeter (or power analyzer) to measure the output current. Input the measured value and press **ENTER**.

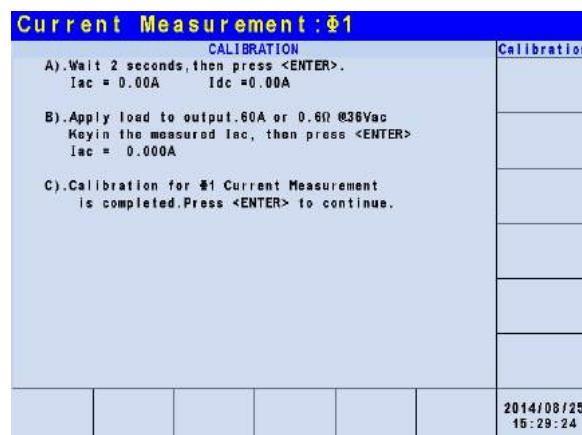

Step C is the last step of Current Measure. ACCURACY CALI. Press **ENTER** to continue the 2nd and 3rd phase current calibration or press **EXIT** to leave this screen. The LCD appears as shown below. Press Yes on the right to save the calibration results.

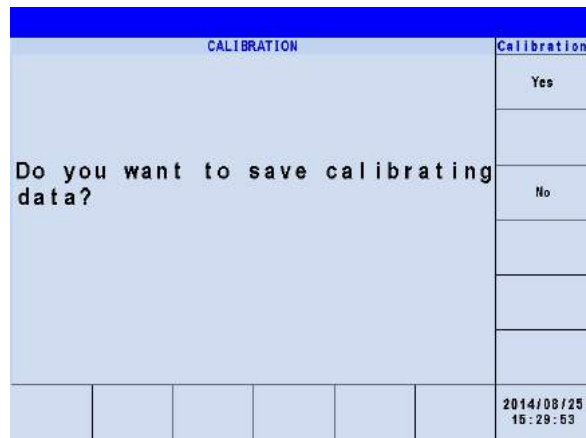

Notice

1. The resistance of applied load has to be constant so that the load current and output voltage is proportional. If not, the step B of URRENT MEAS. ACCURACY is meaningless. The user can use the current that meets step C as the calibration value.
2. Remove protection temporary when executing the calibration. If the applied load is inappropriate, it could cause the Regenerative Grid Simulator to be damaged.

4.2.3 Calibrating External Vref

After entered the password, the CALIBRATION CHOICES are shown on the screen as described in section 4.2. Press External Vref to calibrate the external Vref.

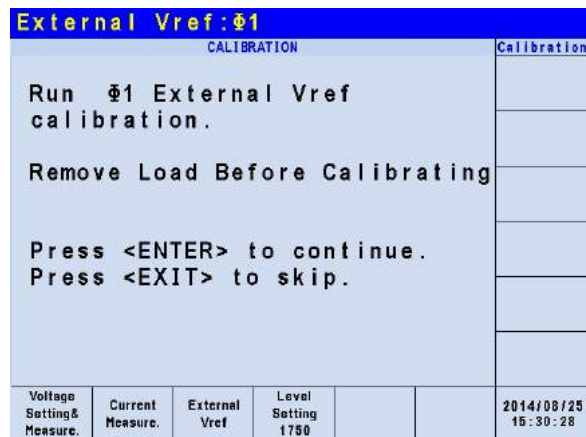



Step A: Short circuit the pin 1 and pin 4 on the Ext. Vref input terminal and press **ENTER**.

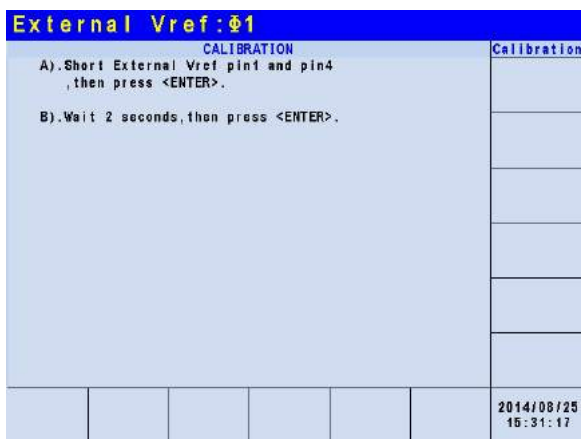

Step B: When the Vref input terminal is short circuited, set the input to 0V and then the LCD will show the Vdc measured by the Regenerative Grid Simulator. The offset voltage is generated by internal ingredients. Wait for 2 seconds and press **ENTER**, the LCD will show the voltage offset Vdc calculated by the Regenerative Grid Simulator.

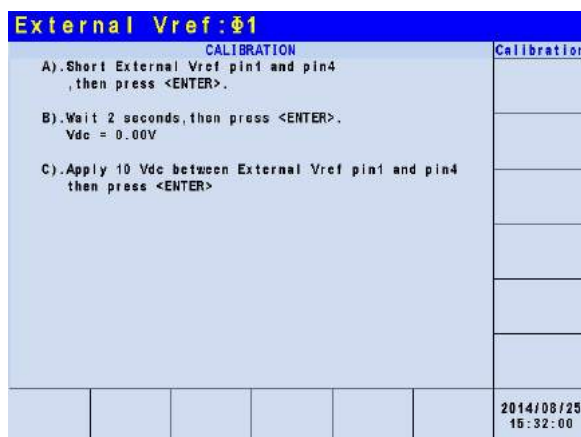

Step C: Disconnect the pin 1 and pin 4 on the Ext. Vref input terminal. Input DC voltage 10Vdc between pin 1 and pin 4 and press **ENTER**.

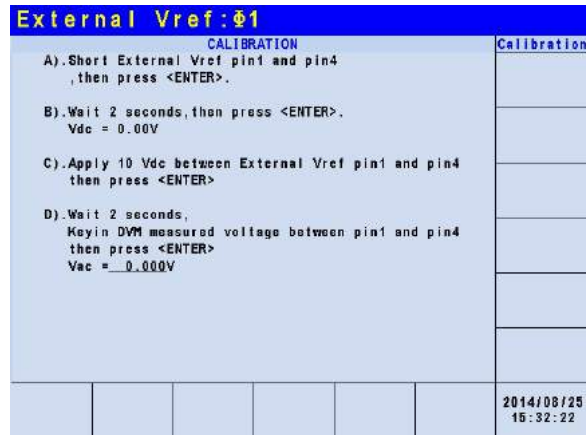

Step D: Use a digital DVM to measure the voltage between pin 1 and pin 4 on the Ext. Vref input terminal. Input the DC voltage and press and press **ENTER**.

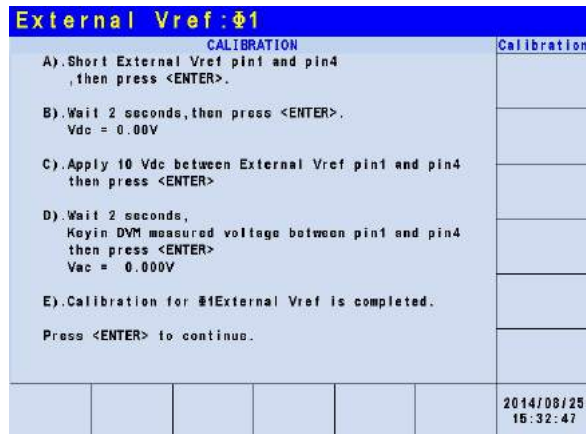

Step E: It is the last step for External Vref CALI. Press **EXIT** to enter into the saving screen as shown below or press **ENTER** to continue other voltage calibration.

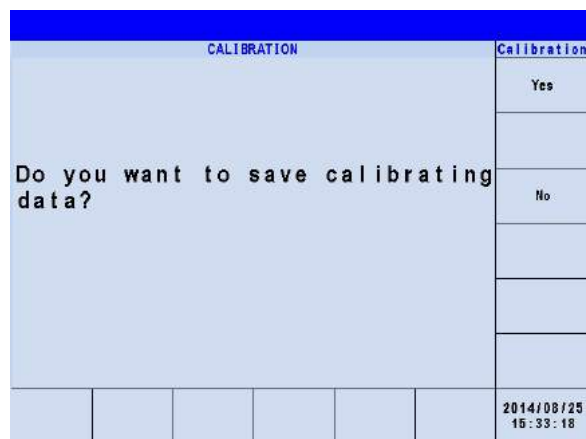

Press **EXIT** in step E and the LCD will show for saving. Press Yes on the right to save the calibration results.

4.3 Adjusting Response Speed

After entered the password, the CALIBRATION CHOICES are shown on the screen as described in section 4.2. The Regenerative Grid Simulator allows the user to adjust the bandwidth response speed. The default is 1750 that is varied with the UUT. The output response speed is set by Level which the higher level the faster response speed and vice versa.

Voltage Setting & Measurement:Φ1					Compensation Settings						
CALIBRATION					CALIBRATION						
Run Φ1 Voltage Setting and Measurement calibration.					This function allows user to adjust the output response speed.						
Remove Load Before Calibrating					When the Level value, is set to high, it could be cause overshoot.						
Press <ENTER> to continue. Press <EXIT> to skip.											
Voltage Setting & Measure.	Current Measure.	External Vref	Level Setting 1750		2000/01/09 01:11:39	Voltage Setting & Measure.	Current Measure.	External Vref	Level Setting 1750		2000/01/09 01:12:53

Procedure for adjusting the response speed:

1. Press Level Setting function key.
2. Turn the RPG to change the response speed and press **ENTER**.

WARNING : For some circumstances, the output voltage could cause Overshoot if the Level setting is too high.

5. Application

5.1 Overview

The Regenerative Grid Simulator not only can program a stable sinusoidal output voltage and frequency, but also provides powerful features to simulate power line interrupts. Users can change the output using the Sequences in LIST mode (see 5.2), or change the output to step by step in STEP mode (see 5.4.) With these functions, the simulations of conditions such as cycle loss, transient peak and power attenuation are very easy.

The Regenerative Grid Simulator is able to measure the related power parameters provided in MAIN PAGE (see 3.3); also it can provide harmonic measurements up to 50 orders (see 5.7.) In addition, the Regenerative Grid Simulator allows the user to edit different harmonic components to synthesize the harmonic distortion waveform (see 5.5). It has the ability to program the inter-harmonic frequency and components, as well as to sweep and overlap the static fundamental waveforms (see 5.6).

3_Phase			LOCAL			QUIT		
OUTPUT SETTING								
#1	Vac =	0.0V	F =	60.00Hz	Setting			
#2	Vac =	0.0V	F =	60.00Hz	OUTPUT: More Setting			
#3	Vac =	0.0V	F =	60.00Hz	Measurement Setting			
MEASUREMENT								
#1	V =	0.00	Po =	0.0	Waveform Viewer			
	I =	0.000	PF =	0.000				
#2	V =	0.00	Po =	0.0	Limitation			
	I =	0.000	PF =	0.000				
#3	V =	0.00	Po =	0.0	Output Mode			
	I =	0.000	PF =	0.000				
Σ	V ₁₂ =	0.00	V ₂₃ =	0.00				
	V ₃₁ =	0.00	Po =	0.0				
List Mode	Pulse Mode	Step Mode	Synthesis	Inter- harmonics	Harmonic Meas.	2014/12/18 10:08:28		

5.2 List Mode

Press Output Mode on the right on the MAIN PAGE (see 3.3) to go into the Output Mode command line and press List Mode at the bottom to go into the List Mode command line.

3_Phase			LIST MODE:STOP			QUIT		
OUTPUT SETTING								
#1	Vac =	0.0V	F =	60.00Hz	List Mode			
#2	Vac =	0.0V	F =	60.00Hz	Trigger			
#3	Vac =	0.0V	F =	60.00Hz	Couple Individual			
MEASUREMENT								
#1	V =	0.00	Po =	0.0	Phase Continue Disable			
	I =	0.000	PF =	0.000				
#2	V =	0.00	Po =	0.0				
	I =	0.000	PF =	0.000				
#3	V =	0.00	Po =	0.0				
	I =	0.000	PF =	0.000				
Σ	V ₁₂ =	0.00	V ₂₃ =	0.00	Edit			
	V ₃₁ =	0.00	Po =	0.0				
List Mode	Pulse Mode	Step Mode	Synthesis	Inter- harmonics	Harmonic Meas.	2014/12/18 10:09:44		

Press Edit on the right to go to the setting page.

3_Phase		LIST MODE				QUIT
LIST MODE SETTING						
Vac start =	0.0V	Vac end =	0.0V			List Mode
F start =	60.00Hz	F end =	60.00Hz			Edit Each
Vdc start =	0.0V	Vdc end =	0.0V			Trigger Auto
Degree =	0.0°	Waveform =	A			
Time =	0.0ms					
Vac start =	0.0V	Vac end =	0.0V			Base Time
F start =	60.00Hz	F end =	60.00Hz			
Vdc start =	0.0V	Vdc end =	0.0V			Count
Degree =	240.0°	Waveform =	A			1
Time =	0.0ms					
Vac start =	0.0V	Vac end =	0.0V			Sequence
F start =	60.00Hz	F end =	60.00Hz			0
Vdc start =	0.0V	Vdc end =	0.0V			Execution Page
Degree =	120.0°	Waveform =	A			
Time =	0.0ms					
List Mode	Pulse Mode	Step Mode	Synthesis	Inter-harmonics	Harmonic Meas.	2014/12/18 10:12:17

The waveform programming in List mode is a combination of Sequences. The output waveform starts from Sequence = 0 and one Sequence after another until the Time or Cycle = 0, stopping the action. The Sequences following will not be executed. Users can edit the output voltage sequence as needed.

Trigger method: Auto / Manual / Excite.

Auto: It finishes all counts when triggered.

Manual: It executes the sequence waveform once, same as Count = 1.

Excite: It is Remote-Excite via the pin 13 of TTL terminal that is triggered by the external trigger signal. See *Appendix A TTL Signal Pin Assignments* for the detail pin assignment.

Couple: Individual / $\Phi 1+\Phi 2+\Phi 3$.

Individual: The three phases are set separately.

$\Phi 1+\Phi 2+\Phi 3$: The setting of second/third phase is the same as the setting of the first phase, so the user only needs to set the first phase.

Phase Continue: Disable/Enable.

Disable: When set to disable, the starting angle of every sequence will follow the Degree setting for motion.

Enable: When set to enable, the starting angle of every sequence will vary automatically following the last output angle of previous sequence. The Degree of all sequences will be invalid when set to enable.

Base sequence unit: Time / Cycle.

Time: The sequence unit is time.

Cycle: The sequence unit is cycle.

Count: The entire sequence execution times, Count = 0: unlimited execution.

Sequence: Sequence number.

The sequence has to start from 0 and the maximum sequence number is 99. The phase difference of the second/third phase and the first phase of Sequence 0 is fixed to differ 120°. Therefore, the user cannot use the angle of the second/third phase in Sequence 0.

Degree: The phase angle when the sequence starts.

Vac start, F start, Vdc start: The initial waveform when the sequence starts.

Vac end, F end, Vdc end: The final waveform when the sequence ends.

Waveform= A / B: Select waveform (see 3.3.3.)

After setting the sequences, press Execution Page on the right to exit List mode and the LCD will show LIST MODE: STOP on the top. STOP indicates the present trigger state. Users can press Trigger on the right to trigger the output and the LCD will show RUNNING to indicate that the List mode is under execution. At the same time users can press Stop to cease the List waveform output. When the Regenerative Grid Simulator finishes all Sequences and Counts, the LCD will return to its initial state and display STOP. The Regenerative Grid Simulator will QUIT at the same time, as shown below.

3_Phase		LIST MODE:STOP				QUIT
OUTPUT SETTING						
#1	Vac =	0.0V	F =	60.00Hz	List Mode	
#2	Vac =	0.0V	F =	60.00Hz	Trigger	
#3	Vac =	0.0V	F =	60.00Hz	Couple Individual	
MEASUREMENT						
#1	V =	0.00	P _o =	0.0	Phase Continue Disable	
	I =	0.000	PF =	0.000		
#2	V =	0.00	P _o =	0.0		
	I =	0.000	PF =	0.000		
#3	V =	0.00	P _o =	0.0		
	I =	0.000	PF =	0.000		
Σ	V ₁₂ =	0.00	V ₂₃ =	0.00	Edit	
	V ₃₁ =	0.00	P _o =	0.0		
List Mode	Pulse Mode	Step Mode	Synthesis	Inter-harmonics	Harmonic Meas.	2014/12/18 10:09:44

3_Phase		LIST MODE:RUNNING				OUT
OUTPUT SETTING						
#1	Vac =	0.0V	F =	60.00Hz	List Mode	
#2	Vac =	0.0V	F =	60.00Hz	Stop	
#3	Vac =	0.0V	F =	60.00Hz		
MEASUREMENT						
#1	V =	0.43	P _o =	0.1		
	I =	0.235	PF =	0.627		
#2	V =	0.25	P _o =	-0.0		
	I =	0.017	PF =	-0.311		
#3	V =	0.26	P _o =	-0.0		
	I =	0.029	PF =	-0.100		
Σ	V ₁₂ =	0.55	V ₂₃ =	0.27		
	V ₃₁ =	0.56	P _o =	0.1		
List Mode	Pulse Mode	Step Mode	Synthesis	Inter-harmonics	Harmonic Meas.	2014/05/17 10:10:13

If the Regenerative Grid Simulator is under operation, pressing **OUT/QUIT** will stop the output and the waveform will be zero volts. Press **OUT/QUIT** again and the Regenerative Grid Simulator only outputs the waveform set in MAIN PAGE. Trigger must be pressed to re-trigger the source.

When pressing  to exit LIST page, the programmed LIST mode waveform will be closed.

Example of LIST Mode in 1_Phase Mode:

Trigger: Auto, **Base:** Time, **Count:** 1

LIST MODE SETTING:

Sequence 0: Vac start = 20V, Vac end = 100V
F start = 50Hz, F end = 50Hz

Vdc start = 0V, Vdc end = 0V
 Degree = 90°, Time = 50ms
 Waveform = A

Sequence 1: Vac start = 20V, Vac end = 20V
 F start = 50Hz, F end = 50Hz
 Vdc start = 0V, Vdc end = 100V
 Degree = 0°, Time = 50ms
 Waveform = A

Sequence 2: Vac start = 20V, Vac end = 120V
 F start = 50Hz, F end = 100Hz
 Vdc start = 0V, Vdc end = 0V
 Degree = 0°, Time = 100ms
 Waveform = A

Following lists the setting pages of LIST MODE.

1_Phase		LIST MODE				QUIT
LIST MODE SETTING						
Vac start	=	0.0V				List Mode
Vac end	=	0.0V				
F start	=	60.00Hz				Trigger
F end	=	60.00Hz				Auto
Vdc start	=	0.0V				Base
Vdc end	=	0.0V				Time
Degree	=	0.0°				Count
Waveform	=	A				1
Time	=	0.0ms				Sequence
						0
						Execution
						Page
List Mode	Pulse Mode	Step Mode	Synthesis	Inter-harmonics	Harmonic Meas.	2014/05/17 10:11:24

1_Phase		LIST MODE				QUIT
LIST MODE SETTING						
Vac start	=	0.0V				List Mode
Vac end	=	0.0V				
F start	=	60.00Hz				Trigger
F end	=	60.00Hz				Auto
Vdc start	=	0.0V				Base
Vdc end	=	0.0V				Time
Degree	=	0.0°				Count
Waveform	=	A				1
Time	=	0.0ms				Sequence
						0
						Execution
						Page
List Mode	Pulse Mode	Step Mode	Synthesis	Inter-harmonics	Harmonic Meas.	2014/05/17 10:11:51

1_Phase		LIST MODE				QUIT
LIST MODE SETTING						
Vac start	=	0.0V	List Mode			
Vac end	=	0.0V				
F start	=	60.00Hz	Trigger Auto			
F end	=	60.00Hz				
Vdc start	=	0.0V	Base Time			
Vdc end	=	0.0V				
Degree	=	0.0°	Count 1			
Waveform	=	A	Sequence 0			
Time	=	0.0ms	Execution Page			
List Mode	Pulse Mode	Step Mode	Synthesis	Inter-harmonics	Harmonic Meas.	2014/05/17 10:12:16

1_Phase		LIST MODE				QUIT
LIST MODE SETTING						
Vac start	=	0.0V	List Mode			
Vac end	=	0.0V				
F start	=	60.00Hz	Trigger Auto			
F end	=	60.00Hz				
Vdc start	=	0.0V	Base Time			
Vdc end	=	0.0V				
Degree	=	0.0°	Count 1			
Waveform	=	A	Sequence 0			
Time	=	0.0ms	Execution Page			
List Mode	Pulse Mode	Step Mode	Synthesis	Inter-harmonics	Harmonic Meas.	2014/05/17 10:12:48

1_Phase		LIST MODE				QUIT
LIST MODE SETTING						
Vac start	=	20.0V	List Mode			
Vac end	=	100.0V				
F start	=	50.00Hz	Trigger Auto			
F end	=	50.00Hz				
Vdc start	=	0.0V	Base Time			
Vdc end	=	0.0V				
Degree	=	0.0°	Count 1			
Waveform	=	A	Sequence 0			
Time	=	50.0ms	Execution Page			
List Mode	Pulse Mode	Step Mode	Synthesis	Inter-harmonics	Harmonic Meas.	2014/12/18 13:32:37

1_Phase		LIST MODE				QUIT
LIST MODE SETTING						
Vac start	=	20.0V	List Mode			
Vac end	=	20.0V				
F start	=	50.00Hz	Trigger Auto			
F end	=	50.00Hz				
Vdc start	=	0.0V	Base Time			
Vdc end	=	100.0V				
Degree	=	0.0°	Count 1			
Waveform	=	A	Sequence 1			
Time	=	50.0ms	Execution Page			
List Mode	Pulse Mode	Step Mode	Synthesis	Inter-harmonics	Harmonic Meas.	2014/12/18 13:31:54

1_Phase		LIST MODE				QUIT
LIST MODE SETTING						
Vac start	=	20.0V	List Mode			
Vac end	=	120.0V				
F start	=	50.00Hz	Trigger Auto			
F end	=	100.00Hz				
Vdc start	=	0.0V	Base Time			
Vdc end	=	0.0V				
Degree	=	0.0°	Count 1			
Waveform	=	A	Sequence 2			
Time	=	100.0ms	Execution Page			
List Mode	Pulse Mode	Step Mode	Synthesis	Inter-harmonics	Harmonic Meas.	2014/05/17 10:17:31

The trigger waveform when the settings are done is shown below:

Phase Continue Disable:

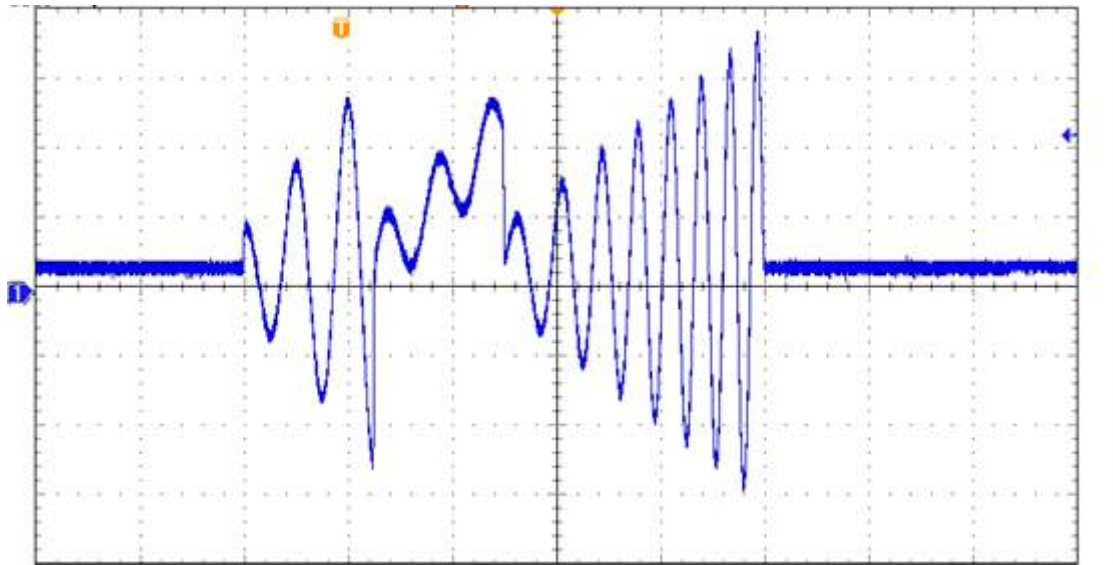

Phase Continue Enable:

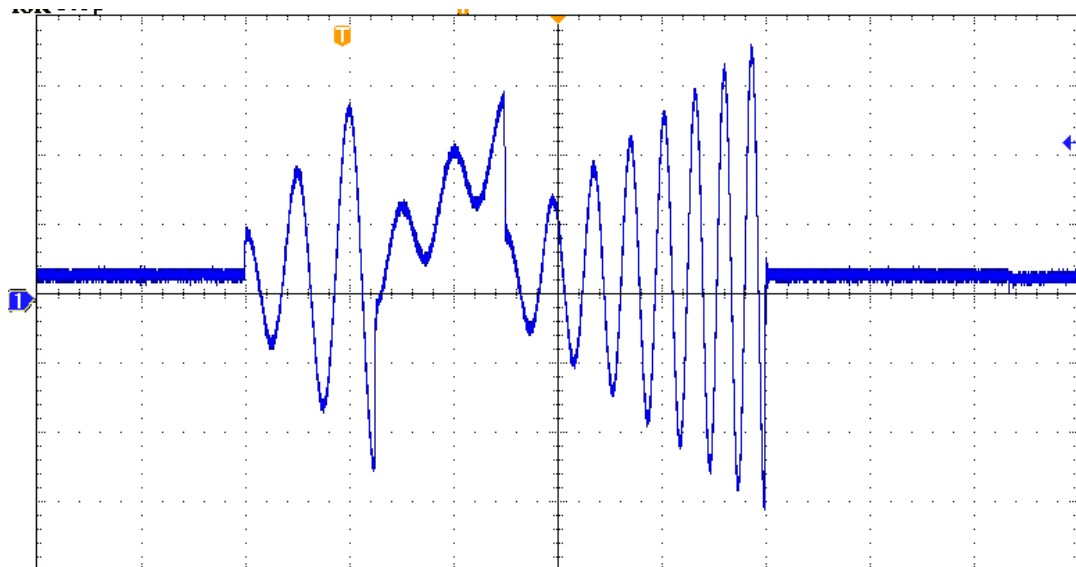

5.3 Pulse Mode

Press Output Mode on the right on the MAIN PAGE (see 3.3) to go into the Output Mode command line and press Pulse Mode at the bottom to go into the Pulse Mode command line.

3_Phase		PULSE MODE : STOP				QUIT
		OUTPUT SETTING				Pulse Mode
#1	Vac =	0.0V	F =	60.00Hz		Trigger
#2	Vac =	0.0V	F =	60.00Hz		
#3	Vac =	0.0V	F =	60.00Hz		
		MEASUREMENT				
#1	V =	0.00	P _o =	0.0		
	I =	0.000	PF =	0.000		
#2	V =	0.00	P _o =	0.0		
	I =	0.000	PF =	0.000		
#3	V =	0.00	P _o =	0.0		
	I =	0.000	PF =	0.000		
	V ₁₂ =	0.00	V ₂₃ =	0.00		Edit
	V ₃₁ =	0.00	P _o =	0.0		
List Mode	Pulse Mode	Step Mode	Synthesis	Inter-harmonics	Harmonic Meas.	2014/05/17 10:26:37

3_Phase		PULSE MODE				QUIT
		PULSE MODE SETTING				Pulse Mode
	Vac =	0.0V	Vdc =	0.0V		Edit Each
#1	F =	60.00Hz	Duty cycle =	50.0%		Trigger Auto
	Degree =	0.0°	Waveform =	A		
	Period =	0.0ms				
	Vac =	0.0V	Vdc =	0.0V		Count 0
#2	F =	60.00Hz	Duty cycle =	50.0%		
	Degree =	0.0°	Waveform =	A		
	Period =	0.0ms				Execution Page
	Vac =	0.0V	Vdc =	0.0V		
#3	F =	60.00Hz	Duty cycle =	50.0%		
	Degree =	0.0°	Waveform =	A		
	Period =	0.0ms				
List Mode	Pulse Mode	Step Mode	Synthesis	Inter-harmonics	Harmonic Meas.	2014/05/17 10:26:53

PULSE mode allows users to program a special waveform and add it to the normal output settings in MAIN PAGE. Waveform programming specifies the time ratio and the duty cycle of the pulse voltage.

Trigger method: Auto / Manual / Excite.

Auto: It finishes all counts when triggered.

Manual: It executes the sequence waveform once, same as Count = 1.

Excite: It is Remote-Excite via the pin 13 of TTL terminal that is triggered by the external trigger signal. See *Appendix A TTL Signal Pin Assignments* for the detail pin assignment.

Count: The count number of pulse.

Vac, F, Vdc: The Vac, F and DC output in pulse voltage.

Duty cycle: The pulse ratio during a duty cycle.

Period: The total length of the duty cycle.

Waveform = A / B: Select waveform (see 3.3.3.)

Degree: The output phase degree of pulse.

After setting the sequences, press Execution Page on the right to exit Pulse mode and the LCD will show PULSE MODE: STOP on the top. STOP indicates the present trigger state. Users can press Trigger on the right to trigger the output and the LCD will show RUNNING to indicate Pulse mode is under execution. The user can also press Stop to cease the Pulse waveform output. When the Regenerative Grid Simulator finishes all Sequences and Counts, the LCD will return to its initial state and display STOP. The Regenerative Grid Simulator will QUIT at the same time, as shown below.

3_Phase		PULSE MODE : STOP				QUIT
OUTPUT SETTING						
#1	Vac =	0.0V	F =	60.00Hz	Pulse Mode	
#2	Vac =	0.0V	F =	60.00Hz	Trigger	
#3	Vac =	0.0V	F =	60.00Hz		
MEASUREMENT						
#1	V =	0.00	Po =	0.0		
	I =	0.000	PF =	0.000		
#2	V =	0.00	Po =	0.0		
	I =	0.000	PF =	0.000		
#3	V =	0.00	Po =	0.0		
	I =	0.000	PF =	0.000		
Σ	V ₁₂ =	0.00	V ₂₃ =	0.00		
	V ₃₁ =	0.00	Po =	0.0	Edit	
List Mode	Pulse Mode	Step Mode	Synthesis	Inter-harmonics	Harmonic Meas.	2014/05/17 10:27:28

3_Phase		PULSE MODE : RUNNING				OUT
OUTPUT SETTING						
#1	Vac =	0.0V	F =	60.00Hz	Pulse Mode	
#2	Vac =	0.0V	F =	60.00Hz	Stop	
#3	Vac =	0.0V	F =	60.00Hz		
MEASUREMENT						
#1	V =	0.40	Po =	0.0		
	I =	0.235	PF =	0.068		
#2	V =	0.24	Po =	-0.0		
	I =	0.022	PF =	-0.510		
#3	V =	0.29	Po =	-0.0		
	I =	0.028	PF =	-0.119		
Σ	V ₁₂ =	0.51	V ₂₃ =	0.31		
	V ₃₁ =	0.58	Po =	0.0		
List Mode	Pulse Mode	Step Mode	Synthesis	Inter-harmonics	Harmonic Meas.	2014/05/17 10:28:21

If the Regenerative Grid Simulator is operating, pressing **OUT/QUIT** will stop the output and the waveform will be zero volts. Press **OUT/QUIT** again the Regenerative Grid Simulator will output the waveform set in MAIN PAGE. Trigger must be pressed to re-trigger the source.

When pressing  to exit PULSE page, the pulse will be closed.

Example of PULSE Mode in 1_Phase Mode:

OUTPUT SETTING: Vac = 50V, F = 50Hz

PULSE MODE SETTING:

Vac = 100V, Vdc = 0V

F = 50Hz, Duty cycle = 35%

Period = 100ms, Degree = 90°

Waveform = A

Trigger: Auto, **Count:** 0

The following lists the setting pages of PULSE MODE.

1_Phase		PULSE MODE				QUIT
PULSE MODE SETTING						
Vac	=	0.0V				Pulse Mode
Vdc	=	0.0V				
F	=	60.00Hz				Trigger Auto
Duty cycle	=	50.0%				Count 0
Degree	=	0.0°				
Waveform	=	A				
Period	=	0.0ms				
Execution Page						
List Mode	Pulse Mode	Step Mode	Synthesis	Inter-harmonics	Harmonic Meas.	2014/05/17 10:29:20

1_Phase		PULSE MODE				QUIT
PULSE MODE SETTING						
Vac	=	0.0V				Pulse Mode
Vdc	=	0.0V				
F	=	60.00Hz				Trigger Auto
Duty cycle	=	50.0%				Count 0
Degree	=	0.0°				
Waveform	=	A				
Period	=	0.0ms				
Execution Page						
List Mode	Pulse Mode	Step Mode	Synthesis	Inter-harmonics	Harmonic Meas.	2014/05/17 10:29:55

1_Phase		PULSE MODE				QUIT
PULSE MODE SETTING						
Vac	=	100.0V				Pulse Mode
Vdc	=	0.0V				
F	=	50.00Hz				Trigger Auto
Duty cycle	=	35.0%				Count 0
Degree	=	90.0°				
Waveform	=	A				
Period	=	100.0ms				
Execution Page						
List Mode	Pulse Mode	Step Mode	Synthesis	Inter-harmonics	Harmonic Meas.	2014/05/17 10:30:52

The trigger waveform when the settings are done is shown below:

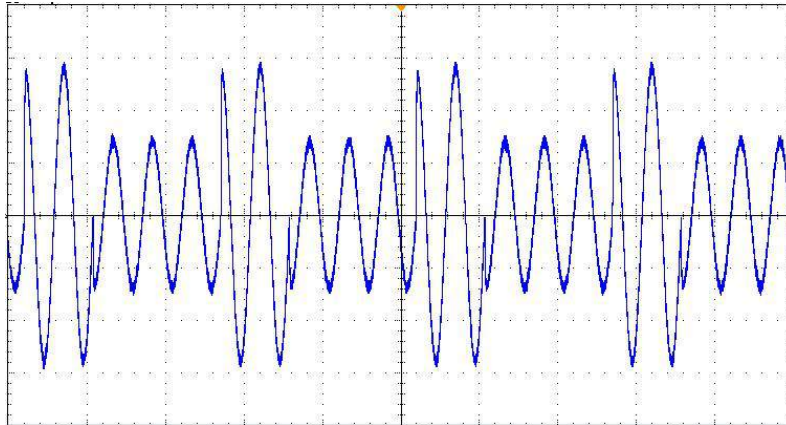

Notice

The Degree function in Pulse mode can only trigger the pulse mode angle once. To trigger the pulse mode for the same angle every time, it can be implemented via List mode.

5.4 Step Mode

Press Output Mode on the right on the MAIN PAGE (see 3.3) to go into the Output Mode command line and press Step Mode at the bottom to go into the Step Mode command line.

3 Phase			STEP MODE : STOP			QUIT
OUTPUT SETTING						Step Mode
#1	Vac = 0.0V	F = 60.00Hz	Vdc = 0.0V			Trigger
#2	Vac = 0.0V	F = 60.00Hz	Vdc = 0.0V			
#3	Vac = 0.0V	F = 60.00Hz	Vdc = 0.0V			
MEASUREMENT						
#1	V = 0.00	Po = 0.0				
	I = 0.000	PF = 0.000				
#2	V = 0.00	Po = 0.0				
	I = 0.000	PF = 0.000				
#3	V = 0.00	Po = 0.0				
	I = 0.000	PF = 0.000				
Σ	V12 = 0.00	V23 = 0.00				Edit
	V31 = 0.00	Po = 0.0				
List Mode	Pulse Mode	Step Mode	Synthesis	Inter-harmonics	Harmonic Meas.	2014/05/17 10:42:28

3 Phase			STEP MODE			QUIT
STEP MODE SETTING						Step Mode
	Vac = 0.0V	ΔVac = 0.0V			Edit Each	
	F = 60.00Hz	ΔF = 0.00Hz			Trigger Auto	
#1	Vdc = 0.0V	ΔVdc = 0.0V	Waveform = A			
	Count = 0	Dwell = 0.0ms				
	Vac = 0.0V	ΔVac = 0.0V			Execution Page	
	F = 60.00Hz	ΔF = 0.00Hz				
#2	Vdc = 0.0V	ΔVdc = 0.0V	Waveform = A			
	Count = 0	Dwell = 0.0ms				
	Vac = 0.0V	ΔVac = 0.0V			Execution Page	
	F = 60.00Hz	ΔF = 0.00Hz				
#3	Vdc = 0.0V	ΔVdc = 0.0V	Waveform = A			
	Count = 0	Dwell = 0.0ms				
List Mode	Pulse Mode	Step Mode	Synthesis	Inter-harmonics	Harmonic Meas.	2014/05/17 10:43:47

STEP Mode provides a simple auto switch function to change the output voltage by stepping. Waveform programming sets the item with an initial voltage, specifies the dwell time and the

change of each step as well as the step number. The output voltage will keep the last state after execution.

Trigger method: Auto / Manual.

Auto: It finishes all counts when triggered.

Manual: The output voltage changes a step every time it operates.

Count: The count number of each change.

Dwell: The time for each step.

Vac, F, Vdc: The Vac, F, DC initial value when STEP mode starts.

Δ Vac, Δ F, Δ Vdc: The difference value of each step. (It can be negative.)

Waveform = A / B: Select waveform (see 3.3.3.)

Degree: The output phase angle of each step.

Press Step Mode at the bottom to go STEP page. The LCD shows STEP MODE: STOP on the top. STOP indicates the present trigger state. Users can press Trigger to trigger the output and the LCD will show RUNNING to indicate Step mode is executing the output. Stop and Pause will show on the screen when the output is triggered. Stop ceases the waveform change of STEP, while Pause keeps the STEP waveform until the user presses TRIG_CONTINUE. When the Regenerative Grid Simulator finishes all Counts, the LCD will show STOP and the Regenerative Grid Simulator will QUIT.

3_Phase			STEP MODE: STOP			QUIT
OUTPUT SETTING						Step Mode
#1	Vac = 0.0V	F = 60.00Hz	Vdc = 0.0V			Trigger
#2	Vac = 0.0V	F = 60.00Hz	Vdc = 0.0V			
#3	Vac = 0.0V	F = 60.00Hz	Vdc = 0.0V			
MEASUREMENT						
#1	V = 0.00	Po = 0.0				Edit
	I = 0.000	PF = 0.000				
#2	V = 0.00	Po = 0.0				
	I = 0.000	PF = 0.000				
#3	V = 0.00	Po = 0.0				
	I = 0.000	PF = 0.000				
Σ	V ₁₂ = 0.00	V ₂₃ = 0.00				
	V ₃₁ = 0.00	Po = 0.0				
List Mode	Pulse Mode	Step Mode	Synthesis	Inter-harmonics	Harmonic Meas.	2014/05/17 10:44:32

3_Phase			STEP MODE: RUNNING			QUIT
OUTPUT SETTING						Step Mode
#1	Vac = 0.0V	F = 60.00Hz	Vdc = 0.0V			Stop
#2	Vac = 0.0V	F = 60.00Hz	Vdc = 0.0V			
#3	Vac = 0.0V	F = 60.00Hz	Vdc = 0.0V			
MEASUREMENT						
#1	V = 0.00	Po = 0.0				Pause
	I = 0.000	PF = 0.000				
#2	V = 0.00	Po = 0.0				
	I = 0.000	PF = 0.000				
#3	V = 0.00	Po = 0.0				
	I = 0.000	PF = 0.000				
Σ	V ₁₂ = 0.00	V ₂₃ = 0.00				
	V ₃₁ = 0.00	Po = 0.0				
List Mode	Pulse Mode	Step Mode	Synthesis	Inter-harmonics	Harmonic Meas.	2014/05/17 10:46:17

If the Regenerative Grid Simulator is outputting, pressing **OUT/QUIT** will stop the output and the waveform will be zero volts. Pressing **OUT/QUIT** again and the Regenerative Grid Simulator will output the waveform set in MAIN PAGE. Users must press Trigger again to re-trigger the output. If the Regenerative Grid Simulator is not outputting, the user can press

ENTER to output the STEP waveform directly.

When pressing  to exit the STEP page, the STEP waveform will stop execution.

The LCD shows Trigger UP and Trigger DOWN when **Trigger = Manual**. The output waveform changes to next voltage if Trigger UP is selected; and the output waveform changes to previous voltage if Trigger DOWN is selected.

3_Phase			STEP MODE : RUNNING			OUT
OUTPUT SETTING						Step Mode
#1	Vac = 0.0V	F = 60.00Hz	Vdc = 0.0V			STOP
#2	Vac = 0.0V	F = 60.00Hz	Vdc = 0.0V			
#3	Vac = 0.0V	F = 60.00Hz	Vdc = 0.0V			Trigger UP
MEASUREMENT						
#1	V = 0.88	Po = 0.2				Trigger DOWN
	I = 0.236	PF = 0.939				
#2	V = 0.28	Po = -0.0				
	I = 0.024	PF = -0.100				
#3	V = 0.75	Po = -0.0				
	I = 0.030	PF = -0.820				
Σ	V12 = 0.99	V23 = 0.68				
	V31 = 0.54	Po = 0.2				
List Mode	Pulse Mode	Step Mode	Synthesis	Inter-harmonics	Harmonic Meas.	2014/05/17 10:47:58

Example of STEP Mode in 1_Phase Mode:

Trigger: Auto

STEP MODE SETTING:

Vac = 40V, ΔVac = 10V
 F = 50Hz, ΔF = 10Hz
 Vdc = 0V, ΔVdc = 20V
 Degree = 90°, Dwell = 60ms
 Count = 3 , Waveform = A

Following lists the setting pages of STEP MODE.

1_Phase		STEP MODE		QUIT
STEP MODE SETTING				Step Mode
Vac	=	0.0V		
ΔVac	=	0.0V		
Vdc	=	0.0V		Trigger Auto
ΔVdc	=	0.0V		
F	=	60.00Hz		
ΔF	=	0.00Hz		
Degree	=	0.0°		
Count	=	0		
Waveform	=	A		
Dwell	=	0.0ms		Execution Page
List Mode	Pulse Mode	Step Mode	Synthesis	Inter-harmonics
				Harmonic Meas.
				2014/05/17 10:52:57

1_Phase		STEP MODE				QUIT
STEP MODE SETTING						
Vac	=	40.0V				Step Mode
ΔVac	=	10.0V				
Vdc	=	0.0V				Trigger
ΔVdc	=	20.0V				Auto
F	=	50.00Hz				
ΔF	=	50.00Hz				
Degree	=	90.0°				
Count	=	3				
Waveform	=	A				
Dwell	=	60.0ms				Execution
						Page
List Mode	Pulse Mode	Step Mode	Synthesis	Inter-harmonics	Harmonic Meas.	2014/05/17 10:54:08

1_Phase		STEP MODE : STOP				OUT
OUTPUT SETTING						
Vac	=	70.0V	F =	100.00Hz		Step Mode
Vdc	=	60.0V				Trigger
MEASUREMENT						
V	=	91.81	Po	=	10.7	
I	=	0.171	PF	=	0.686	
Vac	=	69.46	Vdc	=	59.96	
Iac	=	0.017	Idc	=	0.172	
Vpk	=	158.94	VA	=	15.7	
Ipk	=	0.266	CF	=	1.553	
						Edit
List Mode	Pulse Mode	Step Mode	Synthesis	Inter-harmonics	Harmonic Meas.	2014/05/17 11:01:38

The trigger waveform when the settings are done is shown below:

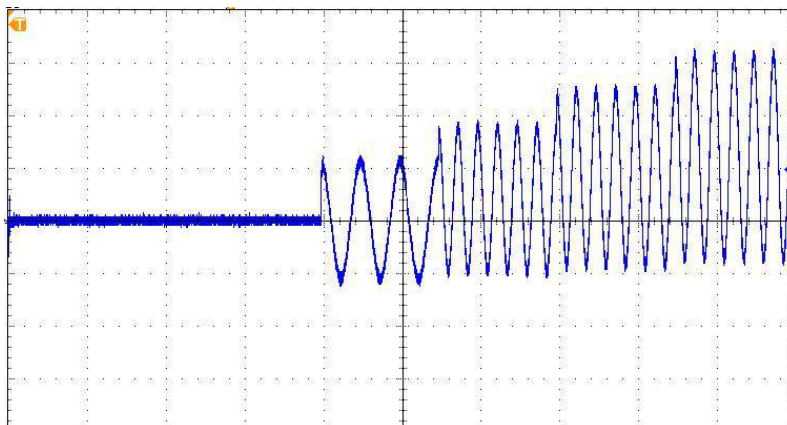

5.5 Synthesis Waveform

Press Output Mode on the right in MAIN PAGE (see 3.3) to enter into the Output Mode command line. Next press Synthesis at the bottom to go into the Synthesis command line. Pressing Edit on the right will enter the Synthesis editing window.

3_Phase			SYNTHESIS : STOP			QUIT
SYNTHESIS WAVEFORM FUNDAMENTAL SETTING						Synthesis
#1	Vac_fund = 0.0V	F_fund = 60Hz	Vdc = 0.0V		Run	
#2	Vac_fund = 0.0V	F_fund = 60Hz	Vdc = 0.0V			
#3	Vac_fund = 0.0V	F_fund = 60Hz	Vdc = 0.0V			
SYNTHESIS WAVEFORM MEASUREMENT						Edit
#1	V = 0.00	P _o = 0.0				
	I = 0.000	PF = 0.000				
#2	V = 0.00	P _o = 0.0				
	I = 0.000	PF = 0.000				
#3	V = 0.00	P _o = 0.0				
	I = 0.000	PF = 0.000				
Σ	V ₁₂ = 0.00	V ₂₃ = 0.00				
	V ₃₁ = 0.00	P _o = 0.0				
List Mode	Pulse Mode	Step Mode	Synthesis	Inter-harmonics	Harmonic Meas.	2014/05/17 11:05:11

3_Phase			SYNTHESIS			QUIT
SYNTHESIS WAVEFORM FUNDAMENTAL SETTING						Synthesis
Vac fundamental = 0.0V		Vdc = 0.0V		F fundamental = 60Hz		Compose Percent-1
F		Degree = 0.0°				
N	%	φ	N	%	φ	Edit ALL Clear All View Waveform Execution Page
2	0.00	0.0	19	0.00	0.0	
3	0.00	0.0	20	0.00	0.0	
4	0.00	0.0	21	0.00	0.0	
5	0.00	0.0	22	0.00	0.0	
6	0.00	0.0	23	0.00	0.0	
7	0.00	0.0	24	0.00	0.0	
8	0.00	0.0	25	0.00	0.0	
9	0.00	0.0	26	0.00	0.0	
10	0.00	0.0	27	0.00	0.0	
11	0.00	0.0	28	0.00	0.0	
12	0.00	0.0	29	0.00	0.0	
13	0.00	0.0	30	0.00	0.0	
14	0.00	0.0	31	0.00	0.0	
15	0.00	0.0	32	0.00	0.0	
16	0.00	0.0	33	0.00	0.0	
17	0.00	0.0	34	0.00	0.0	
18	0.00	0.0	35	0.00	0.0	
List Mode	Pulse Mode	Step Mode	Synthesis	Inter-harmonics	Harmonic Meas.	2015/01/08 15:45:28

61830/61845/61860 Regenerative Grid Simulator provides a Synthesis function for the user to synthesize waveform. The harmonic components range up to 50 orders with the fundamental frequency limited to 50Hz or 60Hz. The user can program the size and phase of each order easily on the LCD. The following is an example figure of the synthesis waveform.

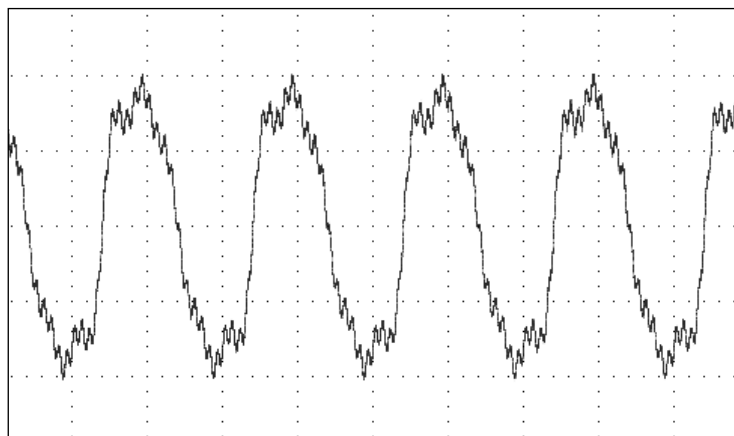

Compose = Value-1 / Value-2 / Value-3/ Percent-1 / Percent-2 / Percent-3: The data form of each harmonic order.

Value: The absolute value.

Percent: The percentage of the fundamental frequency voltage.

The user can program 6 types of synthesis waveform to execution or save.

Vac fundamental: The fundamental frequency voltage, the maximum is limited by RANGE (see 3.3.1.2.)

F fundamental = 50 / 60Hz: The fundamental frequency.

Vdc: The DC voltage component.

Degree: The start angle of the output waveform.

Following is the example of using Synthesis Mode in 1_Phase Mode:

1_Phase LOCAL QUIT					
OUTPUT SETTING					Setting
Vac = 0.0V F = 60.00Hz					OUTPUT: More Setting
MEASUREMENT					Measurement Setting
V = 0.00		Po = 0.0		Waveform Viewer	
I = 0.000		PF = 0.000		Limitation	
Vac = 0.00		Vdc = 0.00		Output Mode	
Iac = 0.000		Idc = 0.000			
Vpk = 0.00		VA = 0.0			
Ipk = 0.000		CF = 0.000			
List Mode	Pulse Mode	Step Mode	Synthesis	Inter-harmonics	Harmonic Meas.
					2014/12/18 10:20:21

Press Output Mode on the right in MAIN PAGE to select any Mode for application.

1_Phase SYNTHESIS:STOP QUIT					
SYNTHESIS WAVEFORM FUNDAMENTAL SETTING					Synthesis
Vac_fund = 0.0V					Run
F_fund =60Hz Vdc = 0.0V					
SYNTHESIS WAVEFORM MEASUREMENT					
V = 0.00		Po = 0.0			
I = 0.000		PF = 0.000			
Vac = 0.00		Vdc = 0.00			
Iac = 0.000		Idc = 0.000			
Vpk = 0.00		VA = 0.0			
Ipk = 0.000		CF = 0.000			
					Edit
List Mode	Pulse Mode	Step Mode	Synthesis	Inter-harmonics	Harmonic Meas.
					2014/05/17 11:07:57

Next, press Synthesis at the bottom to go to Synthesis Mode.

1_Phase SYNTHESIS QUIT					
SYNTHESIS WAVEFORM FUNDAMENTAL SETTING					Synthesis
Vac fundamental = 100.0V Vdc = 0.0V					Compose Value-1
F fundamental =60Hz Degree = 0.0°					
N	V	θ	H	V	θ
2	0.00	0.0	19	0.00	0.0
3	0.00	0.0	20	0.00	0.0
4	0.00	0.0	21	0.00	0.0
5	0.00	0.0	22	0.00	0.0
6	0.00	0.0	23	0.00	0.0
7	20.00	0.0	24	0.00	0.0
8	0.00	0.0	25	0.00	0.0
9	0.00	0.0	25	0.00	0.0
10	0.00	0.0	27	0.00	0.0
11	0.00	0.0	28	0.00	0.0
12	0.00	0.0	29	0.00	0.0
13	0.00	0.0	30	0.00	0.0
14	0.00	0.0	31	0.00	0.0
15	0.00	0.0	32	0.00	0.0
16	0.00	0.0	33	0.00	0.0
17	0.00	0.0	34	0.00	0.0
18	0.00	0.0	35	0.00	0.0
					View Waveform
					Execution Page
List Mode	Pulse Mode	Step Mode	Synthesis	Inter-harmonics	Harmonic Meas.
					2015/01/08 15:47:38

Press Edit on the right to go to editing screen. Use the arrow keys to move the cursor to the appropriate column and use numeric keys to key-in the setting, and then press **ENTER**. The example uses the following settings:

OUTPUT SETTING: Vac = 100V, F = 60Hz

Compose = Percent-1
Edit = Φ3
Vac fundamental = 100.0V
F fundamental = 60Hz
Vdc = 0.0V
Degree = 0.0°



Once the settings are edited, the user can press View Waveform on the right to view the edited output waveform. Press Return to go to previous page.

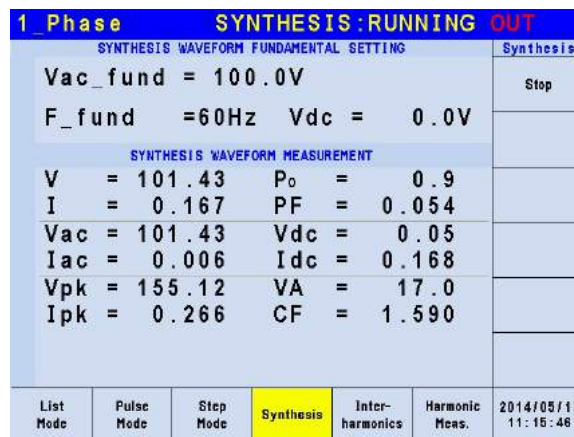

Press Execution Page on the right to return to the Synthesis Mode page. Next, press Run on the right to output the waveform.

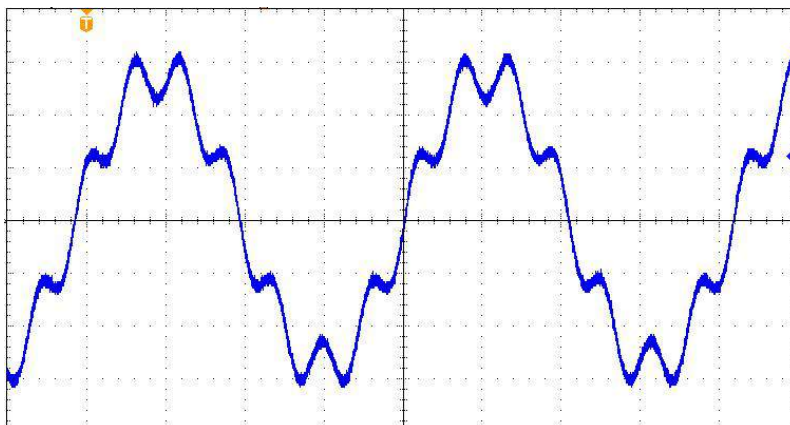

The figure above is the output voltage waveform of the Regenerative Grid Simulator, measured by an oscilloscope and is the same as the user edited waveform.

Notice

- In order to protect the power stage of Regenerative Grid Simulator for practical use, it is necessary to limit the synthesis value or the percentage of each order.
 - $2 \leq \text{order} \leq 10$, value $\leq 90\text{V}$ or percentage $\leq 30\%$.
 - $11 \leq \text{order} \leq 20$, value $\leq 60\text{V}$ or percentage $\leq 20\%$.
 - $21 \leq \text{order} \leq 40$, value $\leq 30\text{V}$ or percentage $\leq 10\%$.
 - $41 \leq \text{order} \leq 50$, value $\leq 15\text{V}$ or percentage $\leq 5\%$.
- If the synthesis waveform exceeds the voltage limit, OUTPUT OVP or DST Protection will occur.

5.6 Inter-harmonics Waveform

Press Output Mode on the right in the MAIN PAGE (see 3.3) to enter into the Output Mode command line. Next press Inter-harmonics at the bottom to go to the Inter-harmonics command line. Press Edit on the right to enter the Inter-harmonics editing window.

3_Phase INTERHARMONICS:STOP						QUIT
OUTPUT SETTING						Interharmon
#1	Vac =	0.0V	F =	60.00Hz		Trigger
#2	Vac =	0.0V	F =	60.00Hz		
#3	Vac =	0.0V	F =	60.00Hz		
MEASUREMENT						
#1	V	=	0.00	Po	=	0.0
	I	=	0.000	PF	=	0.000
#2	V	=	0.00	Po	=	0.0
	I	=	0.000	PF	=	0.000
#3	V	=	0.00	Po	=	0.0
	I	=	0.000	PF	=	0.000
Σ	V ₁₂	=	0.00	V ₂₃	=	0.00
	V ₃₁	=	0.00	Po	=	0.0
List Mode	Pulse Mode	Step Mode	Synthesis	Inter-harmonics	Harmonic Meas.	2014/05/17 11:17:39

3_Phase INTERHARMONICS					QUIT	
INTERHARMONIC WAVEFORM SETTING					Interharmon	
#1	F start	=	0.01Hz		Edit Each	
	F end	=	0.01Hz			
	Time	=	0.00Sec			
	Level	=	0.0%			
#2	F start	=	0.01Hz			
	F end	=	0.01Hz			
	Time	=	0.00Sec			
	Level	=	0.0%			
#3	F start	=	0.01Hz			
	F end	=	0.01Hz			
	Time	=	0.00Sec			
	Level	=	0.0%			
List Mode	Pulse Mode	Step Mode	Synthesis	Inter-harmonics	Harmonic Meas.	2014/05/17 11:18:11

For the Regenerative Grid Simulator Inter-harmonics function, besides the fundamental voltage output, another frequency of variable voltage component is added to test certain anti-interference. Following is the example figure of an inter-harmonic:

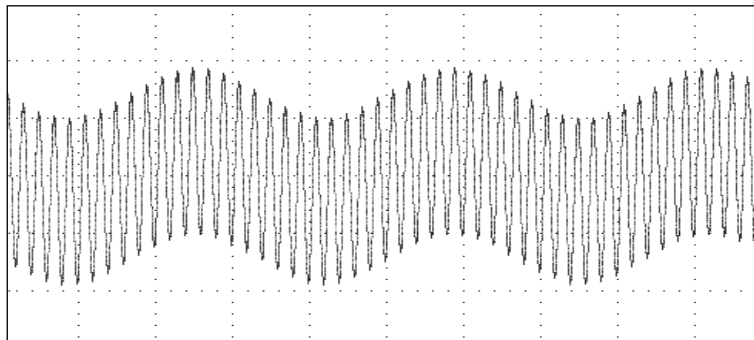
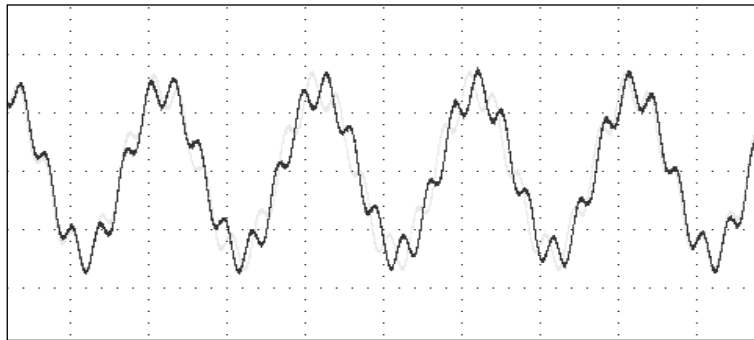

- F start:** The start frequency of scanning wave. The range is 0.01Hz ~ 3000Hz.
- F end:** The end frequency of scanning wave. The range is 0.01Hz ~ 3000Hz.
- Level:** The rms of scanning wave that is the percentage of fundamental voltage set in MAIN PAGE.
- Time:** The scanning time from F start to F end.

The following is the example of using Inter-harmonics Mode in 1_Phase Mode:

1_Phase LOCAL QUIT						
OUTPUT SETTING					Setting	
Vac = 0.0V F = 60.00Hz					OUTPUT: More Setting	
MEASUREMENT					Measurement Setting	
V = 0.00		Po = 0.0		Waveform Viewer		
I = 0.000		PF = 0.000		Limitation		
Vac = 0.00		Vdc = 0.00		Output Mode		
Iac = 0.000		Idc = 0.000				
Vpk = 0.00		VA = 0.0				
Ipk = 0.000		CF = 0.000				
List Mode	Pulse Mode	Step Mode	Synthesis	Inter- harmonics	Harmonic Meas.	2014/12/18 10:20:21

Press Output Mode on the right in the MAIN PAGE to select any Mode for application.

1_Phase INTERHARMONICS:STOP QUIT						
OUTPUT SETTING					Interharmon	
Vac = 0.0V F = 60.00Hz					Trigger	
MEASUREMENT						
V = 0.00		Po = 0.0				
I = 0.000		PF = 0.000				
Vac = 0.00		Vdc = 0.00				
Iac = 0.000		Idc = 0.000				
Vpk = 0.00		VA = 0.0				
Ipk = 0.000		CF = 0.000		Edit		
List Mode	Pulse Mode	Step Mode	Synthesis	Inter- harmonics	Harmonic Meas.	2014/05/17 11:18:50

Next, press Inter-harmonics at the bottom to go to Inter-harmonics Mode.

1_Phase INTERHARMONICS QUIT						
INTERHARMONIC WAVEFORM SETTING					Interharmon	
F start = 500.00Hz						
F end = 500.00Hz						
Time = 10.0Sec						
Level = 20.0%						
					Execution Page	
List Mode	Pulse Mode	Step Mode	Synthesis	Inter- harmonics	Harmonic Meas.	2014/05/17 11:24:40

Press Edit on the right to go to the editing screen. Use the arrow keys to move the cursor to the column to be set and use the numeric keys to key-in the setting and then press **ENTER**. The example uses the following settings:

OUTPUT SETTING: Vac = 60.0V, F = 60Hz
F start = 500.0Hz
F end = 500.0Hz
Level = 20.0%

Time = 10.0Sec

1_Phase INTERHARMONICS : RUNNING OUT						Interharmon
OUTPUT SETTING						Stop
Vac = 60.0V F = 60.00Hz						Pause
MEASUREMENT						
V = 59.90	Po = 0.3					
I = 0.164	PF = 0.033					
Vac = 59.90	Vdc = -0.00					
Iac = 0.021	Idc = 0.165					
Vpk = 92.05	VA = 9.8					
Ipk = 0.238	CF = 1.452					
List Mode	Pulse Mode	Step Mode	Synthesis	Inter-harmonics	Harmonic Meas.	2014/05/17 11:22:19

Press Execution Page on the right to return to the Inter-harmonics Mode page. Next press Trigger on the right to output the waveform.

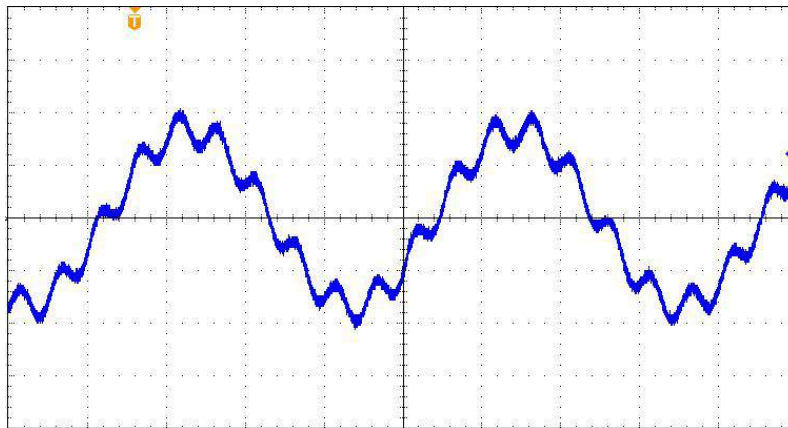

The figure above is the output voltage waveform of the Regenerative Grid Simulator measured by an oscilloscope and is the same as the user edited waveform.

Notice

1. In order to protect the power stage of Regenerative Grid Simulator for practical use, it is necessary to limit the F start and F end related Level.
 - * If $0.01\text{Hz} \leq F \text{ start or } F \text{ end} \leq 500\text{Hz}$, Level $\leq 30\%$.
 - * If $500\text{Hz} < F \text{ start or } F \text{ end} \leq 1000\text{Hz}$, Level $\leq 20\%$.
 - * If $1000\text{Hz} < F \text{ start or } F \text{ end} \leq 2400\text{Hz}$, Level $\leq 10\%$.
 - * If $2400\text{Hz} \leq F \text{ start or } F \text{ end} \leq 3000\text{Hz}$, Level $\leq 5\%$.
2. If the inter-harmonics waveform is over the voltage limit, OUTPUT OVP or DST Protection will occur.

5.7 Harmonic Waveform

Press Output Mode on the right in the MAIN PAGE (see 3.3) to enter into the Output Mode command line. Next press Harmonic Meas. at the bottom to go to the I Harmonic Meas. command line. Press Edit on the right to enter the Harmonic Meas. editing window.

3_Phase HARMONIC MEAS.: STOP						QUIT		
HARMONIC MEASUREMENT SETTING						Harmonic		
#1	THD = 0.0%	DC = 0.0V	Fundamental = 0.0V					
#2	THD = 0.0%	DC = 0.0V	Fundamental = 0.0V			Trigger		
#3	THD = 0.0%	DC = 0.0V	Fundamental = 0.0V					
	N	%	N	%	N	%		
	2	0.00	15	0.00	28	0.00	41	0.00
	3	0.00	16	0.00	29	0.00	42	0.00
	4	0.00	17	0.00	30	0.00	43	0.00
	5	0.00	18	0.00	31	0.00	44	0.00
	6	0.00	19	0.00	32	0.00	45	0.00
	7	0.00	20	0.00	33	0.00	46	0.00
	8	0.00	21	0.00	34	0.00	47	0.00
	9	0.00	22	0.00	35	0.00	48	0.00
	10	0.00	23	0.00	36	0.00	49	0.00
	11	0.00	24	0.00	37	0.00	50	0.00
	12	0.00	25	0.00	38	0.00		
	13	0.00	26	0.00	39	0.00		
	14	0.00	27	0.00	40	0.00		
List Mode	Pulse Mode	Step Mode	Synthesis	Inter-harmonics	Harmonic Meas.	2015/01/08 19:27:42		

3_Phase HARMONIC MEAS.						QUIT
HARMONIC MEASUREMENT						Harmonic
#1	Source = <u>V</u>					Edit Each
	F fundamental = 60Hz					Parameter Value
#2	Source = <u>V</u>					Measurement Single
	F fundamental = 60Hz					
#3	Source = <u>V</u>					Execution Page
	F fundamental = 60Hz					
List Mode	Pulse Mode	Step Mode	Synthesis	Inter-harmonics	Harmonic Meas.	2014/05/17 11:27:38

This function can measure the Total Harmonic Distortion (THD) of the fundamental frequency 50Hz or 60Hz, the DC current, and the fundamental frequency of output current or voltage, also can measure 2 ~ 50 orders of harmonic measurements.

Source = V / I: It measures the source signal output voltage or output current.

V: The output voltage.

I: The output current.

F fundamental = 50 / 60 Hz: The fundamental frequency of source signal.

Measurement = Single / Continue: The way the measurement result displays on LCD.

Single: The display will keep the measured data when set. It takes about 3 seconds to get the results.

Continue: The display updates the measured data when set. It takes about 10 seconds to get stable results.

Parameter = Percent / Value: The data form of each harmonic component.

Percent: The percentage of fundamental frequency value.

Value: The absolute value.

Following is an example of using Harmonic Meas. Mode in 1_Phase Mode:

1_Phase		LOCAL		QUIT	
OUTPUT SETTING					Setting
Vac = 0.0V F = 60.00Hz					OUTPUT: More Setting
MORE SETTING					Measurement Setting
Waveform = A SINE					Waveform Viewer
ON Degree = 0.0					Limitation
OFF Degree = IMMED					Output Mode
Vac S/R = 0.000V/ms					
Vdc S/R = 0.000V/ms					
F S/R = 0.000Hz/ms					
Coupling AC		Output Waveform Selection			2014/12/18 10:22:36

Press OUTPUT: More Settings on the right in the MAIN PAGE to enter into the output selections page.

1_Phase		LOCAL		QUIT	
OUTPUT SETTING					Waveform
Vac = 0.0V F = 60.00Hz					
MORE SETTING					
Waveform A = SINE					View Waveform
Waveform B = SINE					
Coupling AC		Output Waveform Selection			2014/12/18 10:23:30

Next, press Output Waveform Selection at the bottom to go to the output waveform selection page.

1_Phase		LOCAL		QUIT	
OUTPUT SETTING					Waveform
Vac = 0.0V F = 60.00Hz					
MORE SETTING					
Waveform A = DST04					View Waveform
Waveform B = SINE					
Coupling AC		Output Waveform Selection			2014/12/18 10:24:32

Set the Waveform A to DST04 waveform.

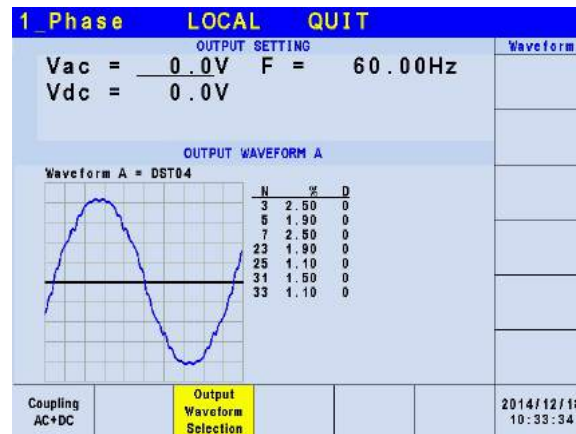

When the waveform setting is done, press View Waveform on the right to view the output waveform, the ratio of each harmonic order and the output angle.

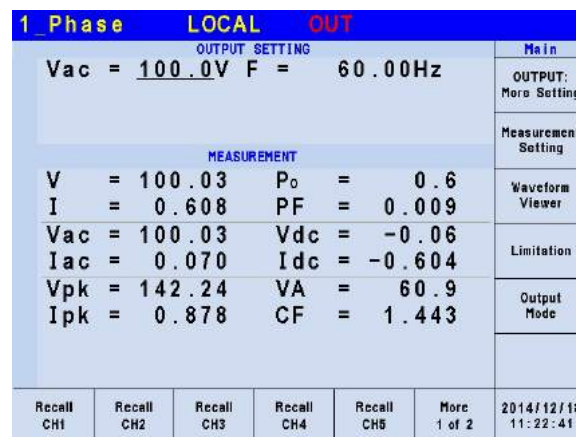

Press Return to go back to the MAIN PAGE and set the Vac to 100.0V, then press **OUT/QUIT** to output waveform.

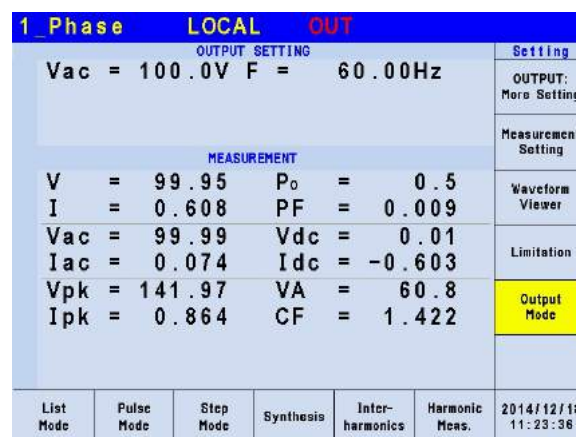

Press Output Mode on the right in the MAIN PAGE to select any Mode.

1_Phase HARMONIC MEAS. :STOP						QUIT
HARMONIC MEASUREMENT SETTING						Harmonic
THD = 0.0%		DC = 0.0V				Trigger
Fundamental = 0.0V						
N	VALUE	N	VALUE	N	VALUE	
2	0.00	15	0.00	28	0.00	
3	0.00	16	0.00	29	0.00	
4	0.00	17	0.00	30	0.00	
5	0.00	18	0.00	31	0.00	
6	0.00	19	0.00	32	0.00	
7	0.00	20	0.00	33	0.00	
8	0.00	21	0.00	34	0.00	
9	0.00	22	0.00	35	0.00	
10	0.00	23	0.00	36	0.00	
11	0.00	24	0.00	37	0.00	
12	0.00	25	0.00	38	0.00	
13	0.00	26	0.00	39	0.00	
14	0.00	27	0.00	40	0.00	
						Edit
List Mode	Pulse Mode	Step Mode	Synthesis	Inter-harmonics	Harmonic Meas.	2015/01/08 19:29:11

Next, press Harmonic Meas. at the bottom to go to the Harmonic Meas. Mode.

1_Phase HARMONIC MEAS.						QUIT
HARMONIC MEASUREMENT						Harmonic
Source = <u>V</u>						Parameter Value
F fundamental = 60Hz						Measurement Single
						Execution Page
List Mode	Pulse Mode	Step Mode	Synthesis	Inter-harmonics	Harmonic Meas.	2014/05/17 11:33:48

Press Edit on the right to go to the editing screen. Use the arrow keys to move the cursor to the column to be set and use the numeric keys to enter the setting and then press **ENTER**. The example uses the following settings:

Source = V
F fundamental = 60 Hz
Measurement = Continue
Parameter = Percent

1_Phase HARMONIC MEAS. :STOP						QUIT
HARMONIC MEASUREMENT SETTING						Harmonic
THD = 0.0%		DC = 0.0V				Trigger
Fundamental = 0.0V						
N	VALUE	N	VALUE	N	VALUE	
2	0.00	15	0.00	28	0.00	
3	0.00	16	0.00	29	0.00	
4	0.00	17	0.00	30	0.00	
5	0.00	18	0.00	31	0.00	
6	0.00	19	0.00	32	0.00	
7	0.00	20	0.00	33	0.00	
8	0.00	21	0.00	34	0.00	
9	0.00	22	0.00	35	0.00	
10	0.00	23	0.00	36	0.00	
11	0.00	24	0.00	37	0.00	
12	0.00	25	0.00	38	0.00	
13	0.00	26	0.00	39	0.00	
14	0.00	27	0.00	40	0.00	
						Edit
List Mode	Pulse Mode	Step Mode	Synthesis	Inter-harmonics	Harmonic Meas.	2015/01/08 19:29:11

Press Execution Page on the right to return to the Harmonic Meas. Mode page. Next press

Trigger on the right to perform the output voltage harmonic measurement.

1_Phase HARMONIC MEAS.:RUNNING OUT							
HARMONIC MEASUREMENT SETTING						Harmonic	
THD = 5.2%		DC = 0.0V				Step	
Fundamental = 99.8V							
N	%	N	%	N	%		
2	0.03	15	0.01	28	0.00	41	0.00
3	2.53	16	0.02	29	0.02	42	0.01
4	0.01	17	0.01	30	0.02	43	0.01
5	1.94	18	0.00	31	1.64	44	0.01
6	0.02	19	0.01	32	0.04	45	0.01
7	2.61	20	0.00	33	1.22	46	0.00
8	0.03	21	0.01	34	0.01	47	0.01
9	0.00	22	0.02	35	0.01	48	0.01
10	0.01	23	2.01	36	0.00	49	0.00
11	0.00	24	0.04	37	0.01	50	0.02
12	0.01	25	1.19	38	0.00		
13	0.00	26	0.01	39	0.01		
14	0.01	27	0.01	40	0.00		

List Mode	Pulse Mode	Step Mode	Synthesis	Inter-harmonics	Harmonic Meas.	2015/01/08 19:41:03
-----------	------------	-----------	-----------	-----------------	----------------	------------------------

After triggered, the user can press DATA on the right to view the measurement of a phase.

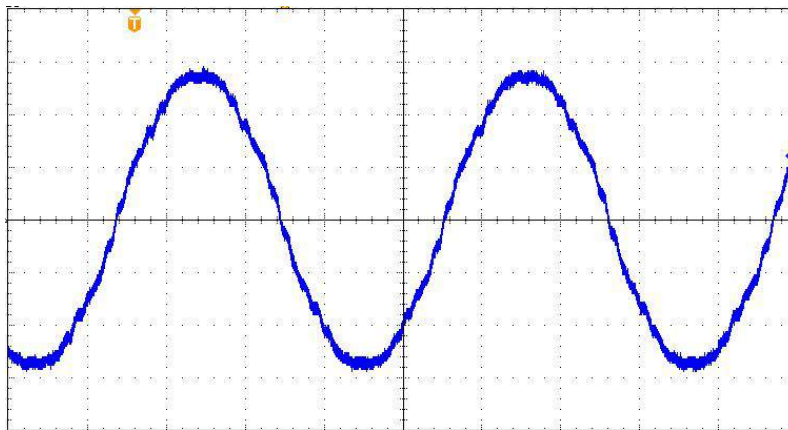

The figure above is the output voltage waveform of the Regenerative Grid Simulator measured by an oscilloscope and is the same as the user edited waveform.

Notice

When the user presses Trigger to execute the current harmonic measurement, the Regenerative Grid Simulator will adjust the internal gain automatically by the measured data so that the Regenerative Grid Simulator can get more accurate data of each harmonic. Thus, it is better to wait for the load to be stable before executing the harmonic measurement. In addition, the load cannot be changed during measurement or the retrieved data may lose its accuracy or cause over current protection.

6. Parallel/Series (Optional) Operation

6.1 Parallel Connection for Regenerative Grid Simulator

6.1.1 Connecting Two Parallel Units for Output

When two Regenerative Grid Simulators are to be connected in parallel mode, it can use the fixture A618002 (Input/Output Terminals for Parallel Connecting) to connect the output of two Regenerative Grid Simulators as the figure shown below.

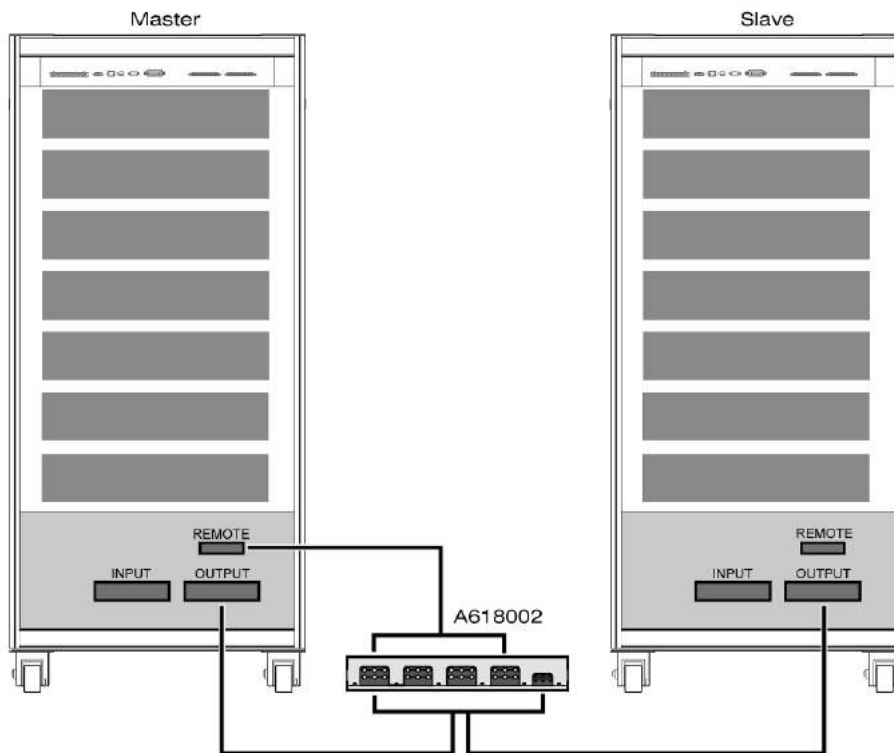

6.1.2 Connecting Two Parallel Units for Input

When two Regenerative Grid Simulators are to be connected in parallel mode, it can use the fixture A618002 (Input/Output Terminals for Parallel Connecting) to connect the input of two Regenerative Grid Simulators as the figure shown below.

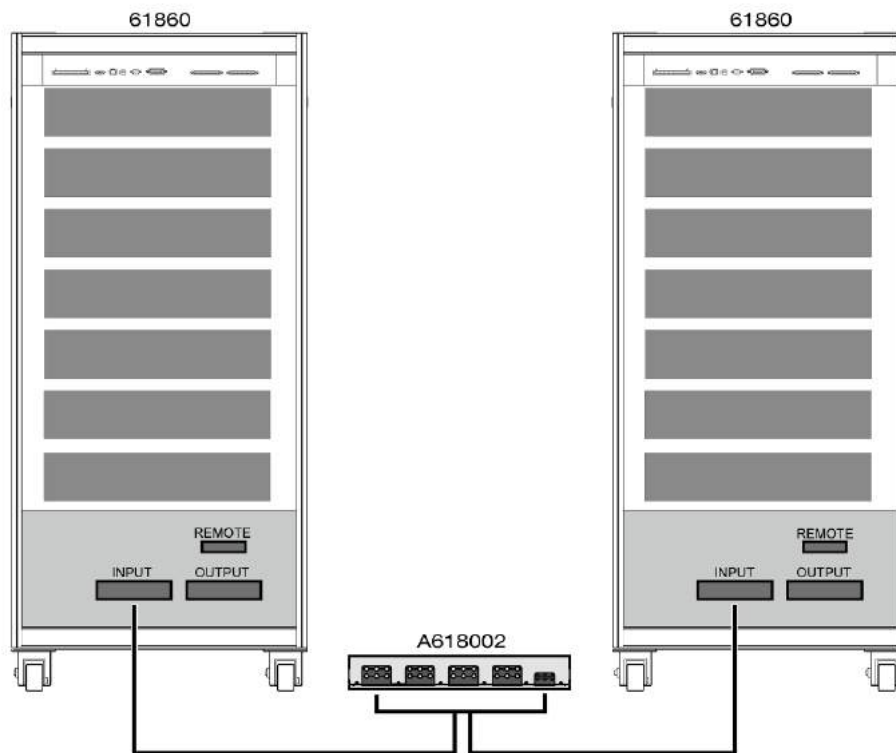

6.1.3 Connecting Three Parallel Units for Output

When three Regenerative Grid Simulators are to be connected in parallel mode, it can use the fixture A618002 (Input/Output Terminals for Parallel Connecting) to connect the output of three Regenerative Grid Simulators as the figure shown below.

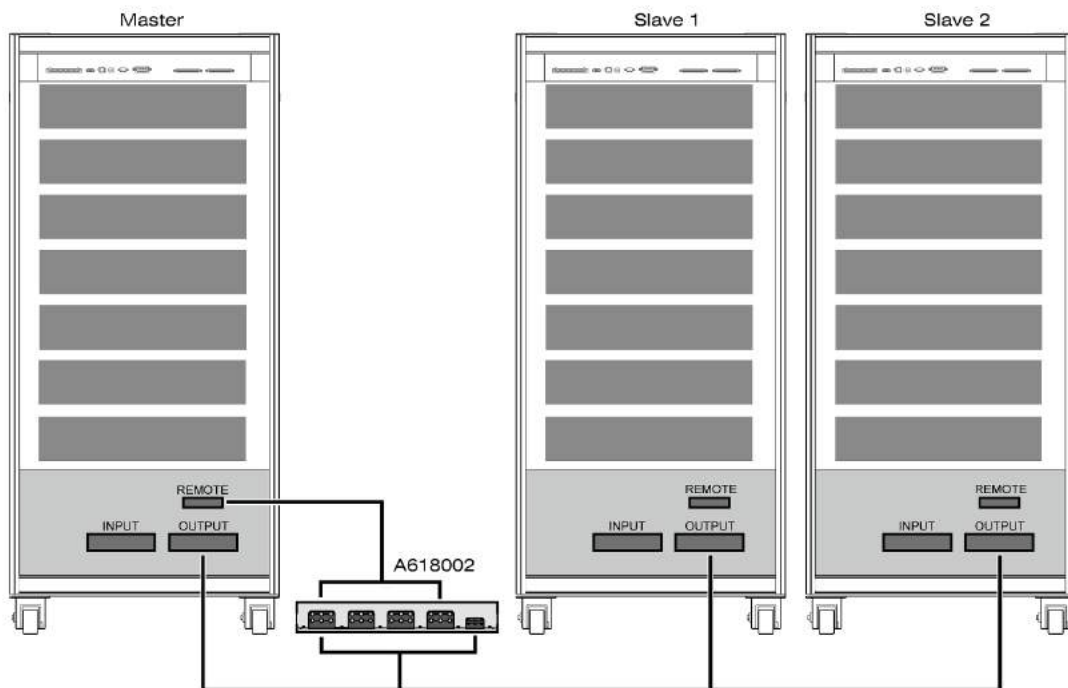

6.1.4 Connecting Three Parallel Units for Input

When three Regenerative Grid Simulators are to be connected in parallel mode, it can use the fixture A618002 (Input/Output Terminals for Parallel Connecting) to connect the input of three Regenerative Grid Simulators as the figure shown below.

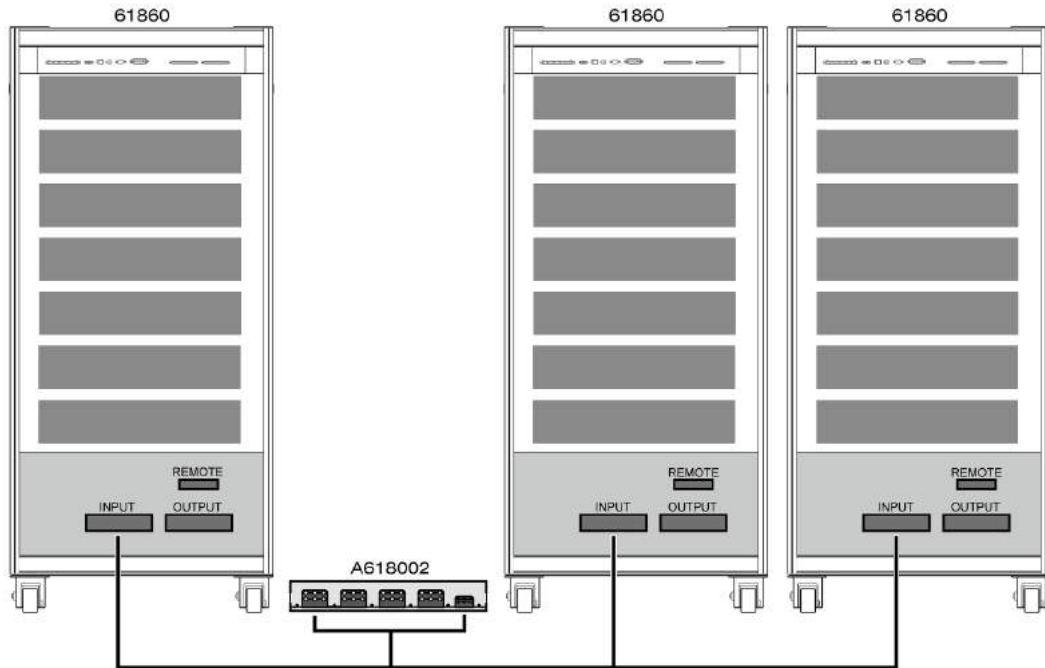

6.1.5 Connecting Four or Five Parallel Units for Output

When four or five Regenerative Grid Simulators are to be connected in parallel mode, it can use the fixture A618002 (Input/Output Terminals for Parallel Connecting) to connect the output of four or five Regenerative Grid Simulators as the figure shown below.

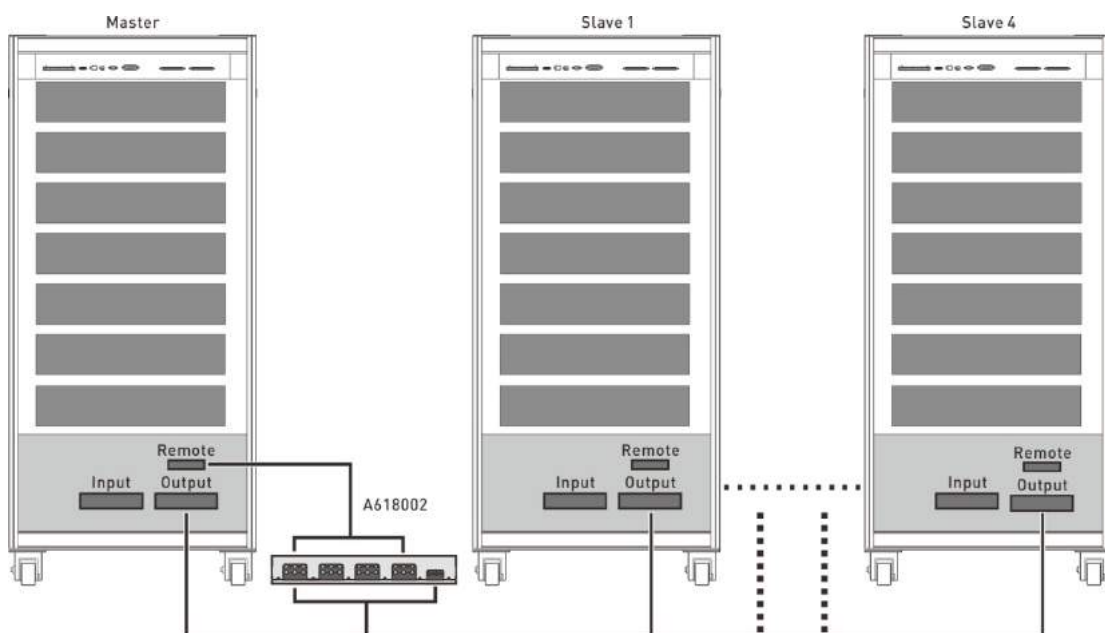

6.1.6 Connecting Four or Five Parallel Units for Input

When four or five Regenerative Grid Simulators are to be connected in parallel mode, it can use the fixture A618002 (Input/Output Terminals for Parallel Connecting) to connect the input of four or five Regenerative Grid Simulators as the figure shown below.

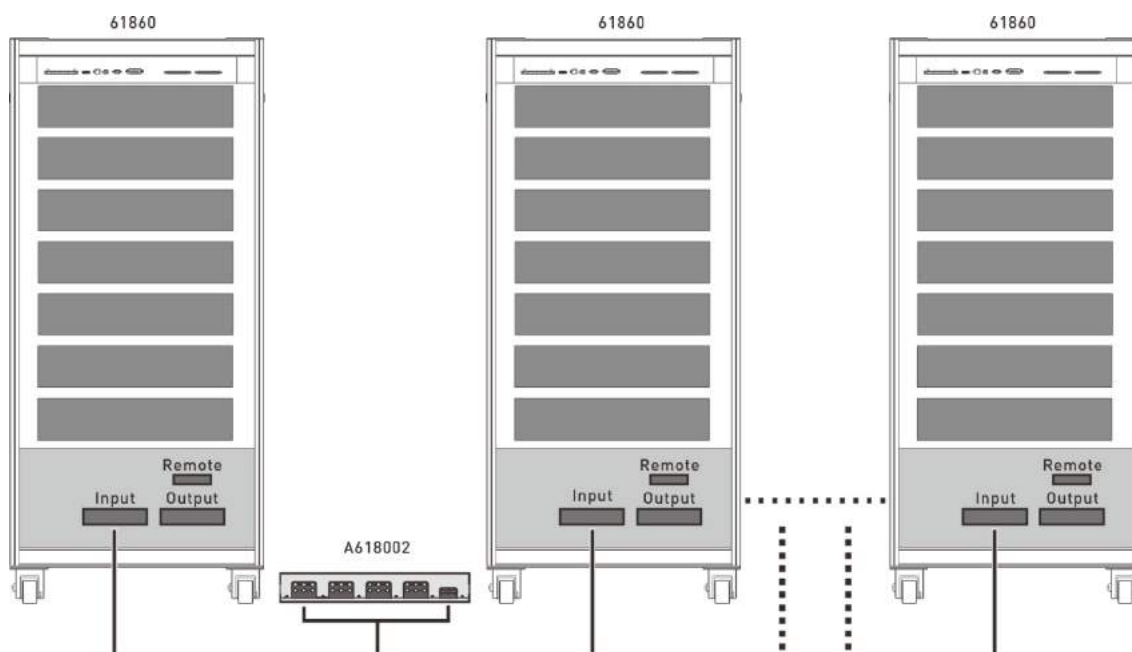

6.2 Series Connection for Regenerative Grid Simulators (Optional)

6.2.1 Connecting Two Simulators at Output in Series

Follow the figure shown below to connect two Regenerative Grid Simulators for use in series mode.

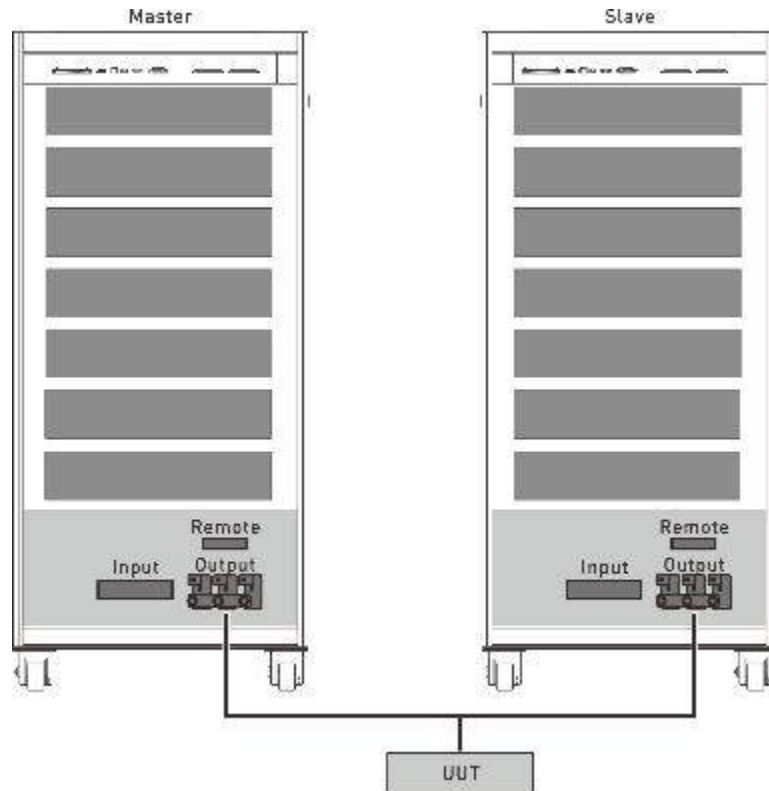

The UUT is connected in between the Master and Slave Regenerative Grid Simulators. The wiring diagram for connecting the output power to the UUT terminals is shown in the figure below.

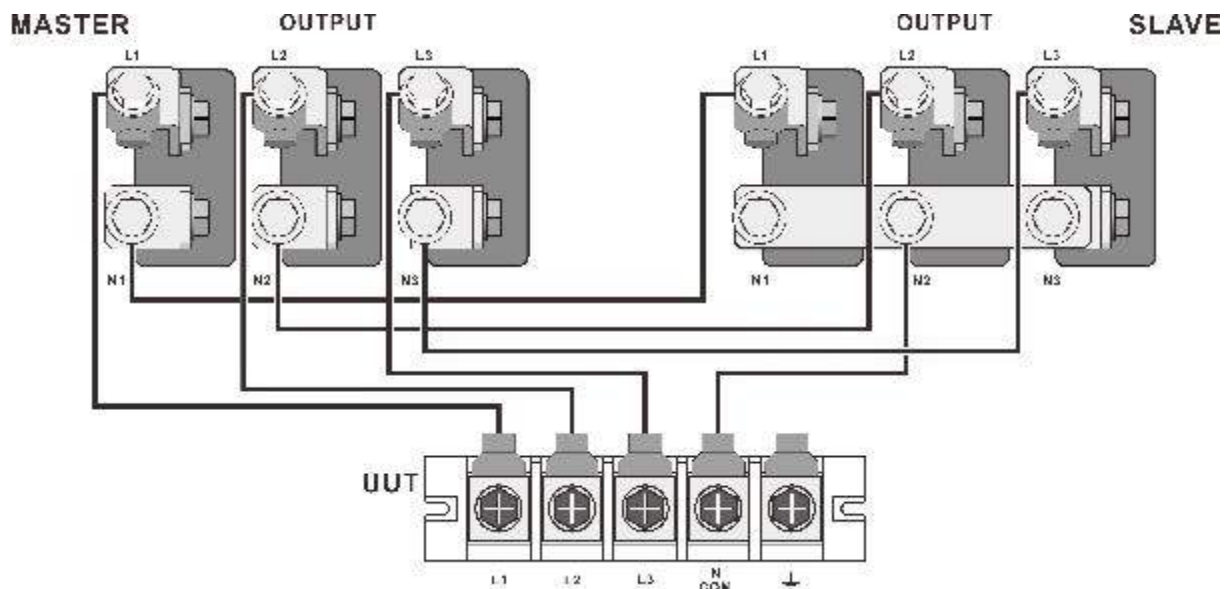

The REMOTE SENSE wires of the Master and Slave Regenerative Grid Simulators are connected to the terminals at the Master and Slave rear in sequence. The REMOTE SENSE wiring diagram is shown below.

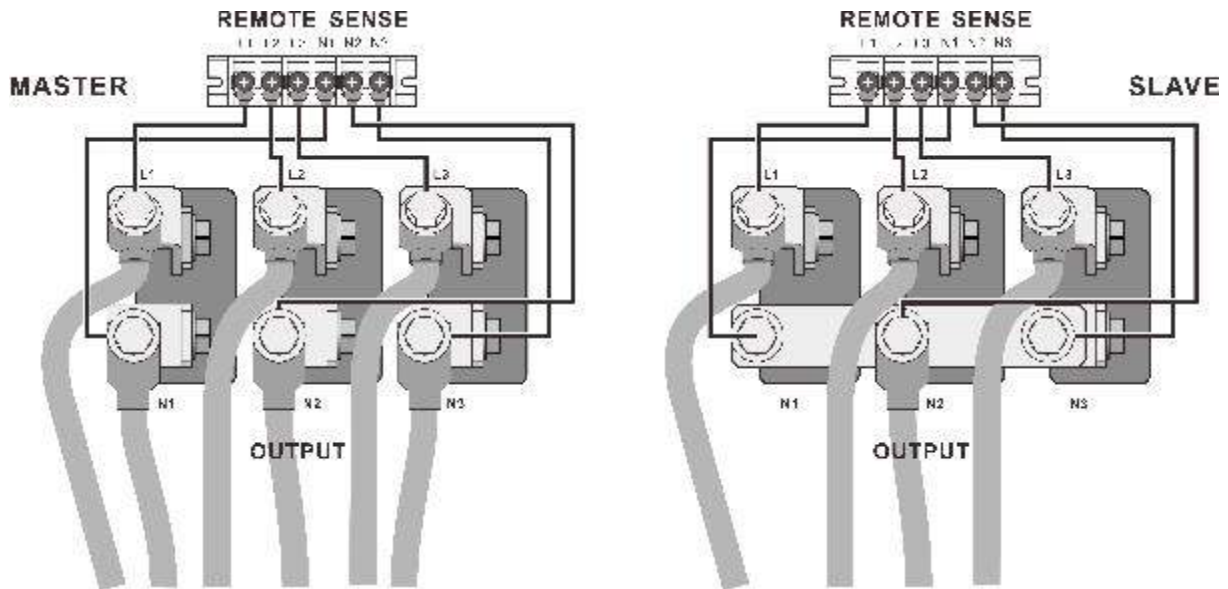

6.3 Cables Connection for Parallel Signal

6.3.1 Cables Connection for Paralleling Two Units

When the Regenerative Grid Simulator is applied to parallel mode, cables are required for transmitting the data in parallel. The connection is as the figure shown below.

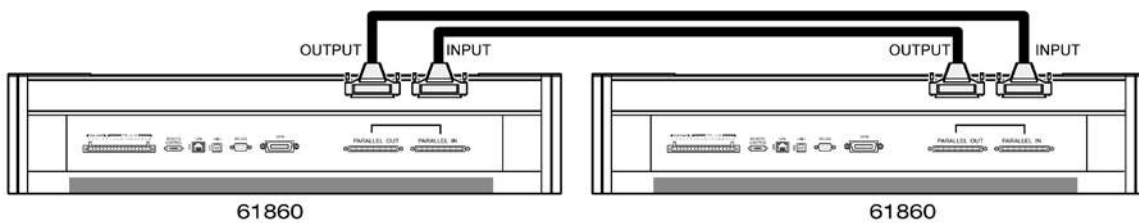

6.3.2 Cables Connection for Paralleling Three Units

When the Regenerative Grid Simulator is applied to parallel mode, parallel cable is required for transmitting the data and the connection is as the figure shown below. Be sure to follow the cable connection as stated if more power modules of Regenerative Grid Simulators (61830/61845/61860) are to be connected in parallel.

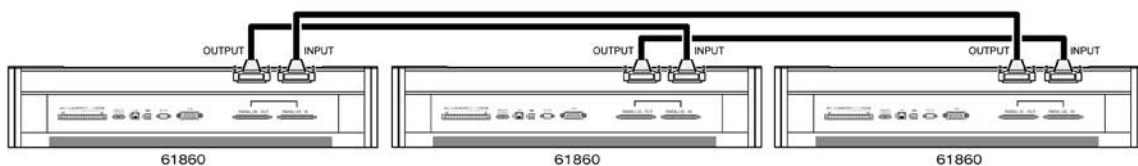

6.3.3 Cables Connection for Paralleling Four Units

When the Regenerative Grid Simulator is applied to parallel mode, parallel cable is required for transmitting the data and the connection is as the figure shown below. Be sure to follow the cable connection as stated if more power modules of Regenerative Grid Simulators (61830/61845/61860) are to be connected in parallel.

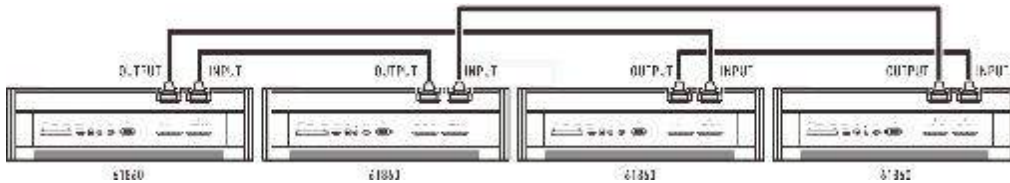

6.3.4 Cables Connection for Paralleling Five Units

When the Regenerative Grid Simulator is applied to parallel mode, it can support up to five units in parallel, and the connection is as the figure shown below. Be sure to follow the cable connection as stated if more power modules of Regenerative Grid Simulators (61830/61845/61860) are to be connected in parallel.

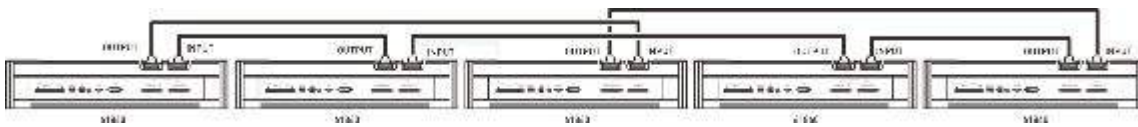

6.4 Signal Cable Connection for Series Mode (Optional)

6.4.1 Connecting Cable for Two Units

When the Regenerative Grid Simulators are used in series mode, cables are required to transmit the data in series. The connection is shown below.

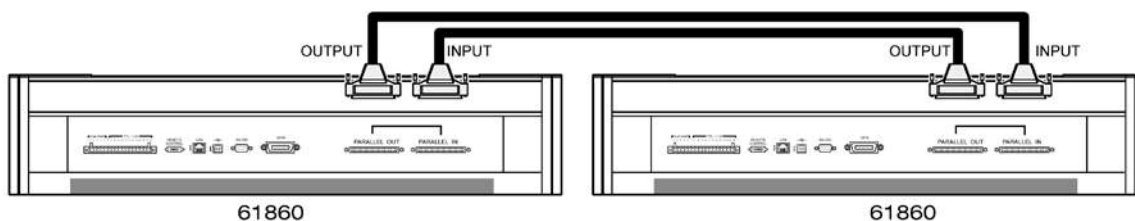

6.5 Setting

6.5.1 Setting Regenerative Grid Simulator to Slave

To set a Regenerative Grid Simulator to Slave, press **CONFIG** in **FUNCTION** menu and select Master/Slave Function in CONFIG menu setting the connection to parallel or series (optional). The setup sequences are listed as below.

1. Press Master/Slave Function.
2. Press Position at the bottom.
3. Turn the RPG to change the Position to Slave1 and press **ENTER** to set it.
4. If the device to be setup is located at the two ends, press Terminator at the bottom and turn the RPG to change the Terminator to Enable.

Notice

1. The Master and the connected Slave devices are all set to Terminator/Enable.
2. Only 2 models are provided for series connection (optional). The Position key can only set to Slave1.
3. When paralleling 3 units, see section 6.3.2 for cable connection. When setting Master/Slave, the recommended left-most connection is Master, and then Master, Salve1, and Salve2 from left to right. In this case, the Master and Salve2 are set to Terminator/ Enable.
4. When paralleling 5 units, see section 6.3.3 for cable connection. When setting Master/Slave, the recommended left-most connection is Master, and then Master, Salve1, Salve2, Salve3, and Salve4 from left to right. In this case, the Master and Salve4 need to set Terminator/ Enable.

3_Phase		LOCAL	QUIT		
OUTPUT SETTING					
#1	Vac =	0.0V	F =	60.00Hz	Config
#2	Vac =	0.0V	F =	60.00Hz	Others
#3	Vac =	0.0V	F =	60.00Hz	Calibration
MEASUREMENT					
#1	V =	0.00	Po =	0.0	System Information
	I =	0.000	PF =	0.000	
#2	V =	0.00	Po =	0.0	Factory Default
	I =	0.000	PF =	0.000	
#3	V =	0.00	Po =	0.0	Master/Slave Function
	I =	0.000	PF =	0.000	
Σ	V ₁₂ =	0.00	V ₂₃ =	0.00	More 2 of 2
	V ₃₁ =	0.00	Po =	0.0	
Position	Number of	Terminator		Function	2016/05/16
Master	Slave	Enable		Enable	13:21:04
	4				

3_Phase		LOCAL	QUIT		
OUTPUT SETTING					
#1	Vac =	0.0V	F =	60.00Hz	Config
#2	Vac =	0.0V	F =	60.00Hz	Others
#3	Vac =	0.0V	F =	60.00Hz	Calibration
MEASUREMENT					
#1	V =	0.00	Po =	0.0	System Information
	I =	0.000	PF =	0.000	
#2	V =	0.00	Po =	0.0	Factory Default
	I =	0.000	PF =	0.000	
#3	V =	0.00	Po =	0.0	Master/Slave Function
	I =	0.000	PF =	0.000	
Σ	V ₁₂ =	0.00	V ₂₃ =	0.00	More 2 of 2
	V ₃₁ =	0.00	Po =	0.0	
Position	Terminator				2016/05/16
Slave4	Enable				13:21:46

6.5.2 Setting Regenerative Grid Simulator to Master

In **FUNCTION** menu, press **CONFIG** and select Master/Slave Function in CONFIG menu to connect multiple devices in parallel or series (optional). The setup sequences are listed as below.

1. Press Master/Slave Function.
2. Press Position at the bottom.
3. Turn the RPG to change the Position to Master and press **ENTER** to set it.

4. Press Number of Slave at the bottom.
5. Turn the RPG to select the Slave number for parallel or series (optional) and press **ENTER** to set it.
6. If the device to be setup is located at the two ends, press Terminator at the bottom and turn the RPG to change the Terminator to Enable.
7. Press Function at the bottom.
8. Turn the RPG to change Function to Parallel if in parallel mode or to Series (optional) if in series mode, and press **ENTER** to set it.
9. Now, it will return to the main menu when set to Master and show a screen with Slave pattern on it when set to Slave.

Notice

1. At least one device needs to be to Slave for parallel application, or it will show “System Connection Fail!” when setting the Master to Enable. See the detailed troubleshooting information in the following section.
2. Only 2 models are provided for series connection (optional). The Number of Slave key can only set to 1.

WARNING

When setting the Number of Slave in Master, the rule is N-1 of Regenerative Grid Simulator units. For instance, the Number of Slave should set to 4 when 5 units are paralleled and 1 when 2 units of connected in series (optional). Incorrect unit number may cause failure in parallel or series connection or damage the device.

6.6 Troubleshooting

When connecting multiple devices for parallel/series (optional) usage, a parallel/series cable is required by each device to transmit the signals. When the set Slave number does not match the actual amount and communication error occurs during connection, follow the troubleshooting procedure described below to solve the problem and execute parallel/series connection again.

6.6.1 When the Connecting Cable is Off

If “System Connection Fail!” occurs when the Master connection is enabled, first check if the parallel/series cable is connected firmly and there is a device dedicated to parallel/series connection or another Regenerative Grid Simulator is set to Slave. If yes, press Retry on the Master to reconnect it.

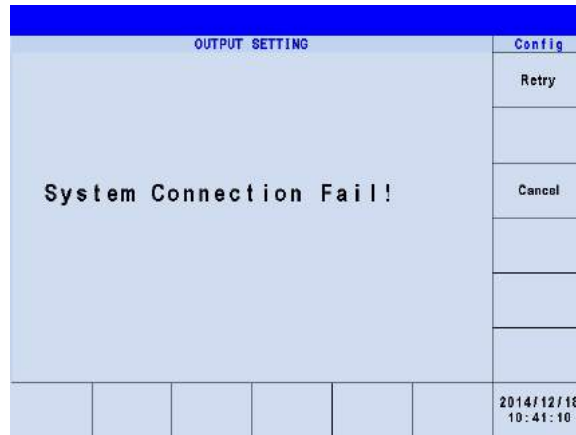

If the parallel/series signal cable is not correctly connected or disconnected when the Master connection is enabled, a warning “SYS SYS_ BUS-WIRE LOSS” will appear. First, check if the parallel/series cable is connected firmly and then reboot the simulator to execute connection again.



When “SYSTEM SHUTDOWN” occurs during connection, power the device off first and check if the parallel/series cable is connected firmly. When done, reboot the device and perform the connection again.

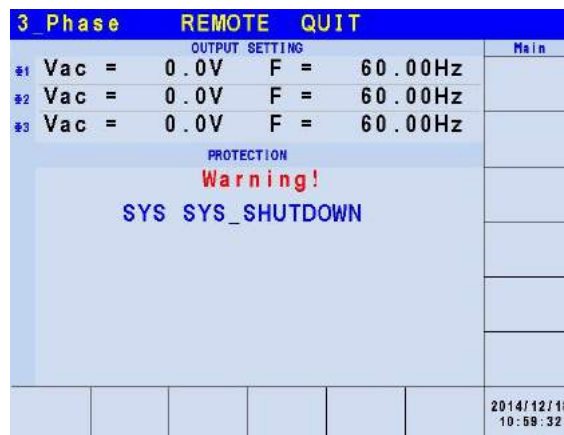

7. AC Load Mode (Option)

7.1 Switching to Load Mode

To set the Regenerative Grid Simulator to ACL mode, press **CONFIG** in the **FUNCTION** menu, and select System Information to set the ACL function by the procedure listed below.

AC LOAD 3 Phase LOCAL QUIT					
UNIT DATA					Config
Model : 61860 SN: 000066					Interface
Display	Version :	1.10Beta-ACLoad			External Iref
Waveform	Version :	1.02.1,1.02.1,1.02.1			System Information
Remote	Version :	1.01 ,1.02			Display
Waveform HDL	Version :	1.01 ,1.01 ,1.01			Protection
GRID Firmware	Version :	1.01 ,1.01 ,1.01			More 1 of 2
GRID HDL	Version :	1.01 ,1.01 ,1.01			
LAN Firmware	Version :	1.10			
OPTION	Option				2017/08/28 16:25:11
AC Load	Function				

1. Press System Information.
2. Press OPTION at the bottom.
3. Turn the RPG to change OPTION to AC Load, and press **ENTER**.
4. Reboot the simulator when the message shows on the LED screen.

7.2 Load Function Interface

When in Load mode and the self-test procedures are done, the screen shows MAIN PAGE (ACL Mode). There are CC Rectifier, CP Rectifier, CR, CC Lead/Lag and CP Lead/Lag 5 functions at the bottom for selection. The regenerative AC load measurement items are displayed under MEASUREMENT. Each output phase has 12 measurement items in total 3 pages which are the same as the Regenerative Grid Simulator (see 3.3).

7.2.1 CC Rectifier Mode

When in CC Rectifier mode, it can change the current amplitude and crest factor (CF) setting in the MAIN PAGE.

AC LOAD 3 Phase LOCAL QUIT						Main
CC-RECTIFIED CONDITION						Measurement Setting
#1	I _{ac} =	0.0A	CF =	1.414		
#2	I _{ac} =	0.0A	CF =	1.414		
#3	I _{ac} =	0.0A	CF =	1.414		
MEASUREMENT						Waveform Viewer
#1	V =	0.00	P _o =	0.0		
	I =	0.000	PF =	0.000		
#2	V =	0.00	P _o =	0.0		
	I =	0.000	PF =	0.000		
#3	V =	0.00	P _o =	0.0		
	I =	0.000	PF =	0.000		
Σ	V ₁₂ =	0.00	V ₂₃ =	0.00		Measurement To Page2
	V ₃₁ =	0.00	P _o =	0.0		
CC Rectifier	CP Rectifier	CR	CC Lead/Lag	CP Lead/Lag		2017/08/28 16:22:44

7.2.2 CP Rectifier Mode

When CP Rectifier mode, it can change the power and crest factor (CF) setting in the MAIN PAGE.

AC LOAD 3 Phase LOCAL QUIT						Main
CP-RECTIFIED CONDITION						Measurement Setting
#1	P =	10W	CF =	1.414		
#2	P =	10W	CF =	1.414		
#3	P =	10W	CF =	1.414		
MEASUREMENT						Waveform Viewer
#1	V =	0.00	P _o =	0.0		
	I =	0.000	PF =	0.000		
#2	V =	0.00	P _o =	0.0		
	I =	0.000	PF =	0.000		
#3	V =	0.00	P _o =	0.0		
	I =	0.000	PF =	0.000		
Σ	V ₁₂ =	0.00	V ₂₃ =	0.00		Measurement To Page2
	V ₃₁ =	0.00	P _o =	0.0		
CC Rectifier	CP Rectifier	CR	CC Lead/Lag	CP Lead/Lag		2017/11/21 17:37:08

7.2.3 CR Mode

When in CR mode, it can change the setting of resistance value in the MAIN PAGE.

AC LOAD 3 Phase LOCAL QUIT						Main
CR CONDITION						Measurement Setting
#1	R =	300.0Ω				
#2	R =	300.0Ω				
#3	R =	300.0Ω				
MEASUREMENT						Waveform Viewer
#1	V =	0.00	P _o =	0.0		
	I =	0.000	PF =	0.000		
#2	V =	0.00	P _o =	0.0		
	I =	0.000	PF =	0.000		
#3	V =	0.00	P _o =	0.0		
	I =	0.000	PF =	0.000		
Σ	V ₁₂ =	0.00	V ₂₃ =	0.00		Measurement To Page2
	V ₃₁ =	0.00	P _o =	0.0		
CC Rectifier	CP Rectifier	CR	CC Lead/Lag	CP Lead/Lag		2017/11/21 17:37:29

7.2.4 CC Lead/Lag Mode

When in CC Lead/Lag mode, it can change the current amplitude and phase setting in the MAIN PAGE. It can also change to current source mode by releasing the phase limit (>90° or <-90°) using the following procedure.

AC LOAD 3_Phase LOCAL QUIT						
CC-LEAD/LAG			CONDITION			Main
#1	I _{ac} =	0.0A	Deg =	0°		
#2	I _{ac} =	0.0A	Deg =	0°		
#3	I _{ac} =	0.0A	Deg =	0°		Measurement Setting
MEASUREMENT						
#1	V =	0.00	P _o =	0.0		Waveform Viewer
	I =	0.000	PF =	0.000		
#2	V =	0.00	P _o =	0.0		
	I =	0.000	PF =	0.000		
#3	V =	0.00	P _o =	0.0		
	I =	0.000	PF =	0.000		
Σ	V ₁₂ =	0.00	V ₂₃ =	0.00		Measurement To Page2
	V ₃₁ =	0.00	P _o =	0.0		
CC Rectifier	CP Rectifier	CR	CC Lead/Lag	CP Lead/Lag		2017/08/28 16:23:58

1. Press **CONFIG** to enter into CONFIG menu.
2. Press Phase limit on the right.
3. Turn the RPG to change the Phase limit to Disable and press **ENTER**.

AC LOAD 3_Phase LOCAL QUIT						
CC-LEAD/LAG			CONDITION			Config
#1	I _{ac} =	0.0A	Deg =	0°		Interface
#2	I _{ac} =	0.0A	Deg =	0°		PhaseLimit Enable
#3	I _{ac} =	0.0A	Deg =	0°		
MEASUREMENT						
#1	V =	0.00	P _o =	0.0		System Information
	I =	0.000	PF =	0.000		
#2	V =	0.00	P _o =	0.0		Display
	I =	0.000	PF =	0.000		
#3	V =	0.00	P _o =	0.0		Protection
	I =	0.000	PF =	0.000		
Σ	V ₁₂ =	0.00	V ₂₃ =	0.00		More 1 of 2
	V ₃₁ =	0.00	P _o =	0.0		
GPIB Address	RS232 Parity	RS232 Baudrate	Remote Inhibit	EXT. ON/OFF	Ethernet Setting	2017/11/21 17:39:23
30	None	115200	Disable	Disable		

7.2.5 CP Lead/Lag Mode

When in CP Lead/Lag mode, it can change the power and phase setting in the MAIN PAGE. It can also change to current source mode by releasing the phase limit (>90° or <-90°) using the following procedure.

AC LOAD 3_Phase LOCAL QUIT						
		CP-LEAD/LAG	CONDITION		Main	
#1	P =	10W	Deg =	0°		
#2	P =	10W	Deg =	0°		
#3	P =	10W	Deg =	0°	Measurement Setting	
MEASUREMENT						
#1	V =	0.00	P _o =	0.0	Waveform Viewer	
	I =	0.000	PF =	0.000		
#2	V =	0.00	P _o =	0.0		
	I =	0.000	PF =	0.000		
#3	V =	0.00	P _o =	0.0		
	I =	0.000	PF =	0.000		
Σ	V ₁₂ =	0.00	V ₂₃ =	0.00	Measurement To Page2	
	V ₃₁ =	0.00	P _o =	0.0		
	CC Rectifier	CP Rectifier	CR	CC Lead/Lag	CP Lead/Lag	2017/11/21 17:38:05

4. Press **CONFIG** to enter into CONFIG menu.
5. Press Phase limit on the right.
6. Turn the RPG to change the Phase limit to Disable and press **ENTER**.

AC LOAD 3_Phase LOCAL QUIT						
		CP-LEAD/LAG	CONDITION		Config	
#1	I _{ac} =	0.0A	Deg =	0°	Interface	
#2	I _{ac} =	0.0A	Deg =	0°	PhaseLimit Enable	
#3	I _{ac} =	0.0A	Deg =	0°		
MEASUREMENT						
#1	V =	0.00	P _o =	0.0	System Information	
	I =	0.000	PF =	0.000		
#2	V =	0.00	P _o =	0.0	Display	
	I =	0.000	PF =	0.000		
#3	V =	0.00	P _o =	0.0	Protection	
	I =	0.000	PF =	0.000		
Σ	V ₁₂ =	0.00	V ₂₃ =	0.00	More 1 of 2	
	V ₃₁ =	0.00	P _o =	0.0		
	GPIOB Address	RS232 Parity	RS232 Baudrate	Remote Inhibit	EXT. ON/OFF	Ethernet Setting
	30	None	115200	Disable	Disable	2017/11/21 17:39:23

8. Remote Operation

8.1 Introduction

The Regenerative Grid Simulator is able to do remote control via USB, GPIB, RS-232 or Ethernet. The USB interface supports USB 2.0/USB 1.1. The GPIB interface is an 8-bit parallel data bus that is synchronized by the bus command from the host. RS-232C interface is a serial bus with less powerful functions; however, the user can do basic remote control via simple programs.

8.1.1 USB Interface

- | | |
|------------------------|--------------------------------------------------------------------------------------------------------------------------------------------------------------------------------------------------------------------------------------------------------------------------------|
| (1) Hardware Support: | USB 2.0 and USB 1.1 |
| (2) Software Support: | USBTMC class and USB488 subclass |
| (3) OS Support: | Windows 98/2000/XP/Vista |
| (4) Installing Driver: | The Regenerative Grid Simulator USB Interface supports USBTMC, so if the PC OS supports USBTMC (installed NI-VISA runtime version 3.00 or above) it is no need to install other drivers. The OS will search for the standard USBTMC driver installation program automatically. |

If the PC OS does not support USBTMC, it is suggested to install the NI-VISA runtime version 3.00 or above first. When the installation of NI-VISA runtime is done, the USBTMC driver program is stored in OS. The PC can communicate with the Regenerative Grid Simulator via NI-VISA after using the USB cable to connect them.

Related Documents:

1. USB Test and Measurement Class (USBTMC) specification, Revision 1.0,
<http://www.usb.org>
2. USB Test and Measurement Class USB488 subclass specification, Revision 1.0,
<http://www.usb.org>

8.1.2 GPIB Interface

The default of GPIB address is 30 and it can only be changed from the “CONFIG” function menu (see 3.4.)

GPIB Capability	Description	Interface Function
Talker/Listener	Commands and response messages can be sent and received via the GPIB bus. Status information can be retrieved by serial query.	AH1, SH1, T6, L4
Service Request	The Regenerative Grid Simulator sets the SRQ to be true if there is a service request.	SR1
Remote/Local	When the Regenerative Grid Simulator is powered on in local mode, it can operate the front panel. In remote mode, all other keys are invalid except LOCAL/REMOTE . Press LOCAL/REMOTE can return to local mode.	RL1

8.1.3 RS-232C Interface

The baud rate of the Regenerative Grid Simulator is set to **115200** with parity set to None. For the RS-232C parameters such as baudrate and parity can be set via "CONFIG" function menu (see section 3.4.)

Only TxD and RxD signals are used for data transmission. The connector is a 9-pin D-subminiature **male** connector. The following table describes the pins and signals of RS-232C connector.

Pin No.	Input/Output	Description
1	---	No Connection
2	INPUT	RxD
3	OUTPUT	TxD
4	---	No Connection
5	GND	GND
6	---	No Connection
7	---	No Connection
8	---	No Connection
9	---	No Connection

Interconnection between the computer (compatible with IBM PC) and the Regenerative Grid Simulator is illustrated below:

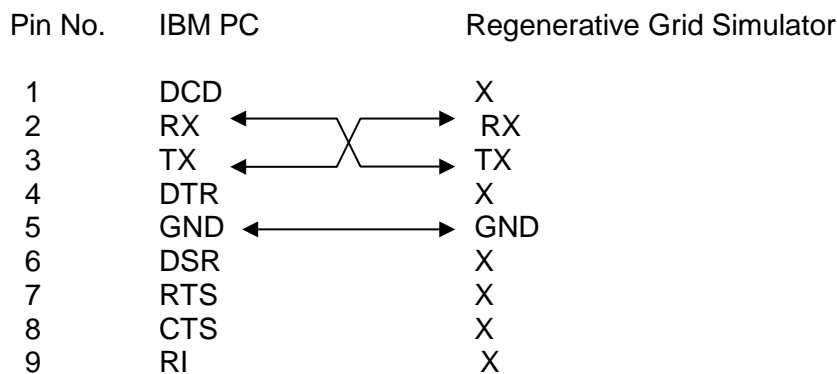

8.1.4 Ethernet Interface

To remote program a Regenerative Grid Simulator via a PC with Ethernet interface, it needs to confirm the IP address, Gateway address and Subnet mask in advance. See 3.4.1.3 for detail settings. To ensure reliable data transmission, TCP is used for data transmission and the communication port is 2101.

8.2 Introduction to Programming

All commands and response messages are transmitted in ASCII code. The response messages must be read completely before sending a new command; otherwise the remaining response messages will be lost and a query interrupt error will occur.

8.2.1 Conventions

Angle brackets	< >	Items in angle brackets are parameter abbreviations.
Vertical bar		Vertical bar separates alternative parameters.
Square brackets	[]	Items in square brackets are optional. For example, OUTP [: STATe] means that : STATe may be omitted.
Braces	{ }	Braces indicate the parameters that may be repeated. The notation <A> {<, B>} means that parameter "A" must be entered while parameter "B" may be omitted or entered once or many times.

8.2.2 Numerical Data Formats

All data programmed to or returned from the Regenerative Grid Simulator are ASCII. The data can be numerical or character string.

Symbol	Description	Example
NR1	It is a digit with no decimal point. The decimal is assumed to be on the right of the least significant digit.	123, 0123
NR2	It is a digit with a decimal point.	12.3, .123
NR3	It is a digit with a decimal point and an exponent.	1.23E+2

8.2.3 Boolean Data Format

Boolean parameter <Boolean> applies ON|OFF format only.

8.2.4 Character Data Format

The character strings returned by query command may in either of the following forms:

<CRD>	Character Response Data: character string with maximum length of 12.
<SRD>	String Response Data: character string.

8.2.5 Basic Definition

Command Tree Table:

The commands of the Regenerative Grid Simulator are structured hierarchically, which is called tree system. Full path must be specified to obtain a particular command. This path is represented in the table by placing the highest node in the farthest left position of the hierarchy. Lower nodes in the hierarchy are indented in the position to the right under the parent node.

Program Header:

Program header is the key word to identify the command according to the IEEE 488.2 syntax described in section 8.4. The Regenerative Grid Simulator accepts characters in both upper and lower cases without any distinction. Program header consists of two unique types, the common command header and the instrument-controlled header.

Common Command and Query Header:

The syntax of common commands and query headers are described in IEEE 488.2. They are used along with the IEEE 488.2 defined common commands and queries. The commands with leading "*" are common commands.

Instrument-Controlled Header:

Instrument-controlled header can be applied to all instrument commands. Each header has a long form and a short form. The Regenerative Grid Simulator only accepts the exact short and long forms. A special notation is used to distinguish the short form header from the long one of the same in this section. The short form of header is shown by upper case characters while the rest of the headers are shown in lower case.

Program Header Separator (:):

If a command has more than one header, a colon must be used to separate them (FETC: CURR?, VOLT:DC 10). At least one space is required to separate the data and program header.

Program Message:

The program message consists of many elements including zero sequence or message components that are separated by the separator (semicolon.)

Program Message Component:

A program component is a single command, programming data, or query.

Example: FREQ?, OUTPut ON.

Program Message Component Separator (;):

The separator (semicolon ;) separates the program message components from another in a program message.

Example: VOLT:AC 110;FREQ 120<PMT>

Program Message Terminator (<PMT>):

A program message terminator can end the program message. Three permitted terminators are:

- (1) <END>: end or identify (EOI)
- (2) <NL>: new line which is a single ASCII encoded byte 0A (10 decimals).
- (3) <NL> <END>: new line with EOI.



Notice

The response message is terminated by <NL> <END> for GPIB, and <NL> for RS-232C.

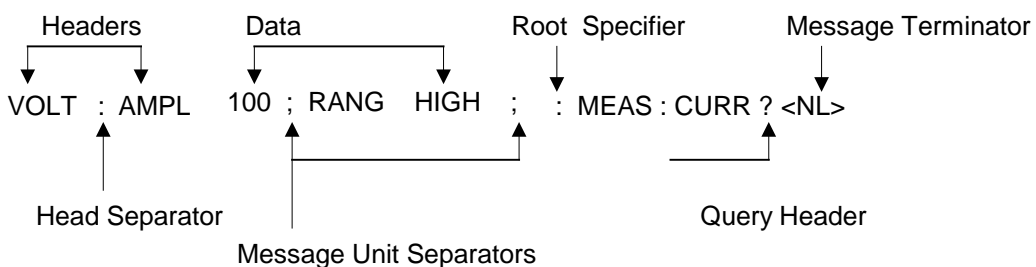

Figure 8-1 Structure of Command Message

- *ESE? Return standard event status enabled

- *ESR? The query reads the Standard Event readings of Event register and clears it. The bits of configuration are the same as Standard Event Status Enabled Register.

- *IDN? Return the Regenerative Grid Simulator identification string.
Return Parameter Chroma ATE,61800,123456,01.00
Chroma ATE : Company name
61800 : Model name
123456 : Serial number
01.00 : Firmware version

- *RCL<n> Restore the values of specified group that stored in memory previously.
Parameter 1 - 10

- *SAV<n> Save the values to a specified group in memory.
Parameter 1 - 10

- * RST It resets the Regenerative Grid Simulator to the initial states. It's better to wait for 3 seconds to send the next command.

- *SRE It sets conditions of Service Request Enabled Register. If one or more of the enabled events of the Status Byte Register is set, the MSS and RQS of Status Byte Register are set too.

- *SRE? This query returns the Service Request Enabled Register.

- *STB? This query returns the Status Byte Register.

Bit Configuration of Status Byte Register

Bit Position	7	6	5	4	3	2	1	0
Condition	--	MSS RQS	ESB	MAV	QUES	--	--	--

- ESB = Event Status Byte Summary
- QUES = Questionable Status Summary
- RQS = Request for Service
- MSS = Master Status Summary
- MAV = Message Available

- * TST? It queries the self-test result of the Regenerative Grid Simulator.

8.4.2 Instrument Command Dictionary

The commands are listed in alphabetical order. Commands followed by question marks (?) are in query forms. When a command has both command and query forms, it is noted in the description of query syntax.

8.4.2.1 SYSTEM Sub-System

SYSTEM

:ERRor?
 :VERSion?
 :LOCal
 :REMote
 :DATE
 :TIME

SYSTEM:ERRor?

Description : This command queries the error string of the command parser.
 Query Syntax : SYSTEM:ERRor?
 Parameter : None
 Return Parameter : Error string response: No Error
 Data Format Error
 Data Range Error
 Too Many Errors
 Execution Error

SYSTEM:VERSion?

Description : This query requests the Regenerative Grid Simulator to identify itself.
 Query Syntax : SYSTEM:VERSion?
 Parameter : None
 Return Parameter : Current version (XX.XX)

SYSTEM:LOCAl

Description : This command can only be used under the control of RS-232C. If
 SYST : LOC is programmed, the Regenerative Grid Simulator will be
 set in the LOCAL state, and the front panel will work.
 Query Syntax : None
 Parameter : None
 Return Parameter : None

SYSTEM:REMote

Description : This command can only be used under the control of RS-232C. If
 SYST : REM is programmed, the Regenerative Grid Simulator will be
 set in the REMOTE state, and the front panel will be disabled except
 the "<PAGE/EXIT> key.
 Query Syntax : None
 Parameter : None
 Return Parameter : None

SYSTEM:DATE

Description : This command sets the date of the Regenerative Grid Simulator real
 time clock.
 Query Syntax : **SYSTEM:DATE?**
 Parameter : <year>,<month>,<day>
 Return Parameter : 2013,01,01

SYSTEM:TIME

Description : This command sets the time (24H) of the Regenerative Grid
 Simulator real time clock.
 Query Syntax : **SYSTEM:TIME?**

Parameter : <hour>,<minute>,<second>
Return Parameter : 20,30,01

8.4.2.2 INSTRUMENT Sub-System

INSTRUMENT

:EDIT
:Couple
:NSElect
:SElect
:PHASe
:OPTION

INSTRUMENT:EDIT

Description : It is very convenient to use a programmed command to set all phases at the same time for a Regenerative Grid Simulator that equipped with multiple phases. If INST:EDIT ALL has been programmed, it will be sent to all phases. INST:EDIT EACH command disables EDIT ALL command.

Query Syntax : INSTRUMENT:EDIT?
Parameter : EACH | ALL
Return Parameter : None

INSTRUMENT : COUPLE

Description : It is easy to use a command to program all phases in a Regenerative Grid Simulator with multiple phases. If INST: COUP ALL is programmed, the command will be sent to all phases. INST: COUP NONE command will cancel COUP ALL command.

Query Syntax : INSTRUMENT : COUPLE?
Parameter : NONE | ALL
Return Parameter : None

INSTRUMENT : NSElect

Description : This command sets individual output for subsequent commands or queries in the multi-phase model. If INST: COUP NONE has been programmed, the phase selection command will send to a specific output phase set by INSTRUMENT: NSElect. If INST: COUP ALL has been programmed, all remote operation commands will send to all output phases. This command only affects the set voltage and queries the measurement data. For instance, if "INST: COUP ALL ", "INST : NSEL 2" and "Meas : VOLT?" are programmed, the Regenerative Grid Simulator will return Φ 2 measurement voltage. INST: NSEL follows the number to select phase.

Query Syntax : INSTRUMENT : NSElect?
Parameter : 1 | 2 | 3
Return Parameter : 1 | 2 | 3

INSTRUMENT : SElect

Description : This command sets individual output for subsequent commands or queries in the multi-phase model. If INST: COUP NONE has been programmed, the phase selection command will send to a specific output phase set by INSTRUMENT: SElect. If INST: COUP ALL has

been programmed, all remote operation commands will send to all output phases. This command only affects the set voltage and queries the measurement data. For instance, if “INST: COUP ALL ”, “INST: SEL OUTPUT2” and “Meas: VOLT?” are programmed, the Regenerative Grid Simulator will return Φ 2 measurement voltage. INST: SELEct follows the number to select phase.

Query Syntax : INSTRument : SELEct?
 Parameter : OUTPUT1 | OUTPUT2 | OUTPUT3
 Return Parameter : OUTPUT1 | OUTPUT2 | OUTPUT3

INSTRument : PHASe

Description : It switches between single phase and three-phase mode.
 Query Syntax : INSTRument : PHASe?
 Parameter : THREE | SINGLE
 Return Parameter : THREE | SINGLE

INSTRument:OPTION

Description : It sets the device to be ACSource or ACLoad mode.
 Query Syntax : INSTRument:OPTION?
 Parameter : SOURCE | LOAD
 Return Parameter : SOURCE | LOAD

8.4.2.3 FETCH and MEASURE Sub-System

FETCH | MEASURE

[: SCALar]

: CURRent	
: AC?	It queries the rms current of AC component.
: DC?	It queries the DC current level.
: ACDC?	It queries the current (AC+DC) rms.
: AMPLitude:MAXimum?	It queries the peak current.
: CRESfactor?	It queries the current crest factor.
: INRush?	It queries the inrush current.
: FREQuency?	It queries the frequency.
: POWer	
: AC	
[: REAL]?	It queries the real power.
: APParent?	It queries the apparent power.
: REACTive?	It queries the reactive power.
: PFACTor?	It queries the power factor.
: TOTal?	It queries the total power.
: TOTal:APParent?	It queries the total apparent power.
: VOLTage	
: AC?	It queries the rms voltage of AC component.
: DC?	It queries the DC voltage.
: ACDC?	It queries the rms voltage
: AMPLitude:MAXimum?	It queries the peak voltage.
: LINE	
: V12?	It queries the voltage difference of phase 1 & 2.
: V23?	It queries the voltage difference of phase 2 & 3.
: V31?	It queries the voltage difference of phase 3 & 1.

This command enables users to get measurement data from the Regenerative Grid Simulator via MEASure and FETCh. MEASure triggers the acquisition to get new data before returning data, while FETCh returns the previously acquired data from measurement buffer.

FETCh [: SCALAr] : CURRent : AC?**MEASure [: SCALAr] : CURRent : AC?**

Description : These queries return the rms current of AC component that is output from the output terminal.

Query Syntax : FETCh : CURRent : AC?, MEASure : CURRent : AC?

Return Parameter : <NR2>

FETCh [: SCALAr] : CURRent : DC?**MEASure [: SCALAr] : CURRent : DC?**

Description : These queries return the DC current that is output from the output terminal.

Query Syntax : FETCh : CURRent : DC?, MEASure : CURRent : DC?

Return Parameter : <NR2>

FETCh [: SCALAr] : CURRent : ACDC?**MEASure [: SCALAr] : CURRent : ACDC?**

Description : These queries return the rms current that is output from the output terminal.

Query Syntax : FETCh : CURRent : ACDC?, MEASure : CURRent : ACDC?

Return Parameter : <NR2>

FETCh [: SCALAr] : CURRent : AMPLitude : MAXimum?**MEASure [: SCALAr] : CURRent : AMPLitude : MAXimum?**

Description : These queries return the absolute value of peak current.

Query Syntax : FETCh : CURRent : AMPLitude : MAXimum?,
MEASure : CURRent : AMPLitude : MAXimum?

Return Parameter : <NR2>

FETCh [: SCALAr] : CURRent : CRESfactor?**MEASure [: SCALAr] : CURRent : CRESfactor?**

Description : These queries return the output current crest factor. It is the ratio of peak output current to rms output current.

Query Syntax : FETCh : CURRent : CRESfactor?
MEASure : CURRent : CRESfactor?

Return Parameter : <NR2>

FETCh [: SCALAr] : CURRent : INRush?**MEASure [: SCALAr] : CURRent : INRush?**

Description : These queries return the inrush current that is output from the output terminal.

Query Syntax : FETCh:CURRent: INRush?, MEASure: CURRent : INRush?

Return Parameter : <NR2>

FETCh [: SCALAr] : FREQuency?**MEASure [: SCALAr] : FREQuency?**

Description : These queries return the output frequency in Hertz.

Query Syntax : FETCh : FREQuency?
MEASure : FREQuency?

Return Parameter : <NR2>

FETCh [: SCALAr] : POWer : AC [: REAL] ?**MEASure [: SCALAr] : POWer : AC [: REAL] ?**

Description : These queries return the real power that is output from the output terminals in watt.

Query Syntax : FETCh : POWer : AC?
 MEASure : POWer : AC?
 Return Parameter : <NR2>

FETCh [: SCALAr] : POWer : AC : APParent?

MEASure [: SCALAr] : POWer : AC : APParent?

Description : These queries return the apparent power that is output from the output terminals in volt-ampere.
 Query Syntax : FETCh : POWer : AC : APParent?
 MEASure : POWer : AC : APParent?
 Return Parameter : <NR2>

FETCh [: SCALAr] : POWer : AC : REACTive?

MEASure [: SCALAr] : POWer : AC : REACTive?

Description : These queries return the reactive power that is output from the output terminals in volt-ampere. Reactive power is calculated by the following formula:

$$VAR = \sqrt{APPARENTPOWER^2 - REALPOWER^2}$$

Query Syntax : FETCh : POWer : AC : REACTive?
 MEASure : POWer : AC : REACTive?
 Return Parameter : <NR2>

FETCh [: SCALAr] : POWer : AC : PFACTor?

MEASure [: SCALAr] : POWer : AC : PFACTor?

Description : These queries return the power factor that is output from the output terminals. Power factor is computed by:
 $PF = TRUE\ POWER / APPARENT\ POWER$
 Query Syntax : FETCh : POWer : AC : PFACTor?
 MEASure : POWer : AC : PFACTor?
 Return Parameter : <NR2>

FETCh [: SCALAr] : POWer : AC : TOTAl ?

MEASure [: SCALAr] : POWer : AC : TOTAl ?

Description : These queries return the total of real power that is output from 3-phase output terminal in watt.
 Query Syntax : FETCh : POWer : AC : TOTAl?
 MEASure : POWer : AC : TOTAl?
 Return Parameter : <NR2>

FETCh [: SCALAr] : POWer : AC : TOTAl : APParent?

MEASure [: SCALAr] : POWer : AC : TOTAl : APParent?

Description : These queries return the total apparent power that is output from 3-phase output terminal in volt-ampere.
 Query Syntax : FETCh : POWer : AC : TOTAl : APParent?
 MEASure : POWer : AC : TOTAl : APParent?
 Return Parameter : <NR2>

FETCh [: SCALAr] : VOLTage : AC?

MEASure [: SCALAr] : VOLTage : AC?

Description : These queries return the rms of AC component that is output from the output terminal.
 Query Syntax : FETCh [: SCALAr] : VOLTage : AC?
 MEASure [: SCALAr] : VOLTage : AC?

Return Parameter : <NR2>

FETCh [: SCALAr] : VOLTage : DC?

MEASure [: SCALAr] : VOLTage : DC?

Description : These queries return the DC composite voltage that is output from the output terminal.

Query Syntax : FETCh [: SCALAr] : VOLTage : DC?
MEASure [: SCALAr] : VOLTage : DC?

Return Parameter : <NR2>

FETCh [: SCALAr] : VOLTage : ACDC?

MEASure [: SCALAr] : VOLTage : ACDC?

Description : These queries return the rms that is output from the output terminal.

Query Syntax : FETCh [: SCALAr] : VOLTage : ACDC?
MEASure [: SCALAr] : VOLTage : ACDC?

Return Parameter : <NR2>

FETCh [: SCALAr] : VOLTage : AMPLitude : MAXimum?

MEASure [: SCALAr] : VOLTage : AMPLitude : MAXimum?

Description : These queries return the absolute value of peak voltage.

Query Syntax : FETCh : VOLTage : AMPLitude : MAXimum?,
MEASure : VOLTage : AMPLitude : MAXimum?

Return Parameter : <NR2>

FETCh [: SCALAr] : LINE : V12?

MEASure [: SCALAr] : LINE : V12?

Description : These queries return the line voltage between phase 1 and 2.

Query Syntax : FETCh [: SCALAr] : LINE : V12?
MEASure [: SCALAr] : LINE : V12?

Return Parameter : <NR2>

FETCh [: SCALAr] : LINE : V23?

MEASure [: SCALAr] : LINE : V23?

Description : These queries return the line voltage between phase 2 and 3.

Query Syntax : FETCh [: SCALAr] : LINE : V23?
MEASure [: SCALAr] : LINE : V23?

Return Parameter : <NR2>

FETCh [: SCALAr] : LINE : V31?

MEASure [: SCALAr] : LINE : V31?

Description : These queries return the line voltage between phase 3 and 1.

Query Syntax : FETCh [: SCALAr] : LINE : V31?
MEASure [: SCALAr] : LINE : V31?

Return Parameter : <NR2>

8.4.2.4 OUTPUT Sub-System

OUTPut

[: STATe]
 : RELay
 : SLEW
 : VOLTage
 : AC
 : DC
 :FREQency
 : COUPling
 : MODE
 : PROTection
 :CLEAr

OUTPut [: STATe]

Description : This command enables or disables the output of the Regenerative Grid Simulator. Disabled output is to set the output voltage amplitude to 0 Volt.
 Query Syntax : OUTPut [: STATe]?
 Parameter : OFF | ON
 Return Parameter : OFF | ON

OUTPut : RELay

Description : This command sets output relay on or off.
 Query Syntax : OUTPut : RELay?
 Parameter : OFF | ON, ON sets the output relay of the Regenerative Grid Simulator on (close), OFF sets the output relay of the Regenerative Grid Simulator off (open).
 Return Parameter : OFF | ON

OUTPut : SLEW : VOLTage : AC

Description : This command sets the slew rate of the AC output voltage.
 Query Syntax : OUTPut : SLEW : VOLTage : AC?
 Parameter : <NR2>, the valid range is 0.000V/ms ~ 1200.000V/ms.
 Return Parameter : <NR2>

OUTPut : SLEW : VOLTage : DC

Description : This command sets the slew rate of the DC composite voltage.
 Query Syntax : OUTPut : SLEW : VOLTage : DC?
 Parameter : <NR2>, the valid range is 0.000V/ms ~ 1200.000V/ms.
 Return Parameter : <NR2>

OUTPut : SLEW : FREQuency

Description : This command sets the slew rate of the output frequency.
 Query Syntax : OUTPut : SLEW : FREQuency?
 Parameter : <NR2>, the valid range is 0.000 Hz/ms ~ 1600.000Hz/ms
 Return Parameter : <NR2>

OUTPut : COUPling

Description : This command selects the coupling of the output signals.
 Query Syntax : OUTPut : COUPling?
 Parameter : AC | DC | ACDC

Return Parameter : AC | DC | ACDC

OUTPut : MODE

Description : This command sets the operation mode and “FIXED” mode is the general operation mode.

Query Syntax : OUTPut : MODE?

Parameter : FIXED | LIST | PULSE | STEP | SYNTH | INTERHAR

Return Parameter : FIXED | LIST | PULSE | STEP | SYNTH | INTERHAR

OUTPut : PROTection : CLEAR

Description : This command clears the latch that disables the output when over current (OCP), over temperature (OTP), over power (OPP) or remote inhibit (RI) is detected. All conditions that generate the faults must be resolved before the latch is cleared.

Query Syntax : None

Parameter : None

Return Parameter : None

8.4.2.5 SOURCE Sub-System

[SOURCE :]

CURRent

: LIMit

: DELay

: INRush

: STARt

: INTerval

FREQency

[: {CW | IMMEDIATE}]

: LIMit

VOLTage

[: LEVel][: IMMEDIATE][:AMPLitude]

: AC

: DC

: LIMit

: AC

: DC

: PLUS

: MINus

POWER

: PROTection

FUNcTION

: SHAPe

: SHAPe

: A

: A

: MODE

: THD

: AMP

: B

: B

: MODE

: THD
: AMP

[SOURCE:] CURRENT : LIMIT

Description : This command sets the rms current limit of the Regenerative Grid Simulator for protection.
Query Syntax : [SOURCE :] CURRENT : LIMIT?
Parameter : <NR2>, the valid range is 0.00 ~ maximum current spec. of the specific model (unit: A.)
Return Parameter : <NR2>

[SOURCE:] CURRENT : DELAY

Description : This command sets the time delayed for triggering over current protection.
Query Syntax : [SOURCE :] CURRENT : DELAY?
Parameter : <NR2>, the valid range is 0.0 ~ 5.0 (unit: 0.1 second.)
Return Parameter : <NR2>

[SOURCE:] CURRENT : INRUSH : START

Description : This command sets the time to start the inrush current measurement.
Query Syntax : [SOURCE :] CURRENT : INRUSH : START?
Parameter : <NR2>, the valid range is 0 ~ 9999 (unit: ms.)
Return Parameter : <NR2>

[SOURCE:] CURRENT : INRUSH : INTERVAL

Description : This command sets the measuring interval for inrush current measurement.
Query Syntax : [SOURCE :] CURRENT : INRUSH : INTERVAL?
Parameter : <NR2>, the valid range is 0 ~ 9999 (unit: ms.)
Return Parameter : <NR2>

[SOURCE:] FREQUENCY [: {CW | IMMEDIATE}]

Description : This command sets the output waveform frequency for the Regenerative Grid Simulator in Hz.
Query Syntax : [SOURCE :] FREQUENCY [: {CW | IMMEDIATE}]?
Parameter : <NR2>, the valid range is 15.00 ~ 100.00 (unit: Hz.)
Return Parameter : <NR2>

[SOURCE:] FREQUENCY : LIMIT

Description : This command sets the output frequency limit for the Regenerative Grid Simulator.
Query Syntax : [SOURCE :] FREQUENCY : LIMIT?
Parameter : <NR2>, the valid range is 15.00 ~ 100.00 (unit: Hz)
Return Parameter : <NR2>

[SOURCE:] POWER:PROTECTION

Description : This command sets the OPP (Over Power Protection) for the Regenerative Grid Simulator.
Query Syntax : [SOURCE :] POWER:PROTECTION?
Parameter : <NR2>, the valid range is 0.0 ~ maximum power of specific model (unit: W.)
Return Parameter : <NR2>

[SOURce:] VOLTage [: LEVel][: IMMEDIATE][: AMPLitude] : AC

Description : This command sets the AC composite output voltage in Volts.
 Query Syntax : [SOURce :] VOLTage [: LEVel][: IMMEDIATE][: AMPLitude] : AC?
 Parameter : <NR2>, the valid range is 0.0 ~ 300.0.
 Return Parameter : <NR2>

[SOURce:] VOLTage [: LEVel][: IMMEDIATE][: AMPLitude] : DC

Description : This command sets the DC composite output voltage in Volts.
 Query Syntax : [SOURce :] VOLTage [: LEVel][: IMMEDIATE][: AMPLitude] : DC?
 Parameter : <NR2>, the valid range is -424.2 ~ 424.2.
 Return Parameter : <NR2>

[SOURce:] VOLTage : LIMit : AC

Description : This command sets the Vac LIMIT to restrict the value of Vac.
 Query Syntax : [SOURce :] VOLTage : LIMit : AC?
 Parameter : <NR2>, the valid range is 0.0 ~ 300.0 (unit: V.)
 Return Parameter : <NR2>

[SOURce:] VOLTage : LIMit : DC : PLUS

Description : This command sets the Vdc Limit(+).
 Query Syntax : [SOURce :] VOLTage : LIMit : DC : PLUS?
 Parameter : <NR2>, the valid range is -424.2 ~ 424.2 (unit: V)
 PS: The lower limit cannot exceed Vdc Limit(-).
 Return Parameter : <NR2>

[SOURce:] VOLTage : LIMit : DC : MINus

Description : This command sets the Vdc Limit(-).
 Query Syntax : [SOURce :] VOLTage : LIMit : DC : MINus?
 Parameter : <NR2>, the valid range is -424.2 ~ -424.2 (unit: V)
 PS: The upper limit cannot exceed Vdc Limit(+).
 Return Parameter : <NR2>

[SOURce:] FUNCTION : SHAPe

Description : This command specifies the waveform buffer. The Regenerative Grid Simulator output has two buffers and users need to specify to use the contents of the waveform buffer A or B.
 Query Syntax : [SOURce :] FUNCTION : SHAPe?
 Parameter : A | B
 Return Parameter : A | B

[SOURce:] FUNCTION : SHAPe : A

Description : This command specifies the waveform buffer A for use.
 Query Syntax : [SOURce :] FUNCTION : SHAPe : A?
 Parameter : SINE | SQUA | CSIN | DST<01..30> | USR<01..06>
 Return Parameter : SINE | SQUA | CSIN | DST<01..30> | USR<01..06>

[SOURce:] FUNCTION : SHAPe : A : MODE

Description : This command selects the mode for the clipping in waveform buffer A for use.
 Query Syntax : [SOURce :] FUNCTION : SHAPe : A : MODE?
 Parameter : AMP | THD
 Return Parameter : AMP | THD

[SOURCE:] FUNCTION : SHAPE : A : THD

Description : This command sets the clipped THD percentage for the clipping in waveform buffer A.
Query Syntax : [SOURCE :] FUNCTION : SHAPE : A : THD?
Parameter : <NR2>, the valid range is 0.0% ~ 43%.
Return Parameter : <NR2>

[SOURCE:] FUNCTION : SHAPE: A : AMP

Description : This command sets the clipped peak percentage for the clipping in waveform buffer A.
Query Syntax : [SOURCE :] FUNCTION : SHAPE : A : AMP?
Parameter : <NR2>, the valid range is 0.0% ~ 100%.
Return Parameter : <NR2>

[SOURCE:] FUNCTION : SHAPE : B

Description : This command specifies the waveform buffer B for use.
Query Syntax : [SOURCE :] FUNCTION : SHAPE : B?
Parameter : SINE | SQUA | CSIN | DST<01..30> | USR<01..06>
Return Parameter : SINE | SQUA | CSIN | DST<01..30> | USR<01..06>

[SOURCE:] FUNCTION : SHAPE : B : MODE

Description : This command selects the mode for the clipping in waveform buffer B for use.
Query Syntax : [SOURCE :] FUNCTION : SHAPE : B : MODE?
Parameter : AMP | THD
Return Parameter : AMP | THD

[SOURCE:] FUNCTION : SHAPE : B : THD

Description : This command sets the clipped THD percentage for the clipping in waveform buffer B.
Query Syntax : [SOURCE :] FUNCTION : SHAPE : B : THD?
Parameter : <NR2>, the valid range is 0.0% ~ 43%.
Return Parameter : <NR2>

[SOURCE:] FUNCTION : SHAPE: B : AMP

Description : This command sets the clipped peak percentage for the clipping in waveform buffer B.
Query Syntax : [SOURCE :] FUNCTION : SHAPE : B : AMP?
Parameter : <NR2>, the valid range is 0.0% ~ 100%.
Return Parameter : <NR2>

8.4.2.6 CONFIGURE Sub-System

[SOURCE:]

CONFigure
: INHibit
: EXTernal
: COUPling
: EXTON

[SOURCE:] CONFigure : INHibit

Description : This command sets the Remote Inhibit function.

Query Syntax : [SOURce :] CONFigure : INHibit?
 Parameter : DISABLE | ENABLE
 Return Parameter : DISABLE | ENABLE

[SOURce:] CONFigure : EXTERNAL

Description : This command sets if enabling the External-V Reference function.
 Query Syntax : [SOURce :] CONFigure : EXTERNAL?
 Parameter : OFF | ON
 Return Parameter : OFF | ON

[SOURce:] CONFigure : COUPLing?

Description : This command sets the External-V Reference to be AC_AMPLIFIER or DC_LEVEL to control the Regenerative Grid Simulator output.
 Query Syntax : [SOURce :] CONFigure : COUPLing?
 Parameter : AC | DC
 Return Parameter : AC | DC

[SOURce:] CONFigure : EXTON

Description : This command sets the External ON/OFF control.
 Query Syntax : [SOURce :] CONFigure : EXTON?
 Parameter : DISABLE | ENABLE
 Return Parameter : DISABLE | ENABLE

8.4.2.7 PHASE Sub-System**[SOURce:]**

PHASe
 : ON
 : OFF
 : P12
 : P13
 : SEQuence
 : THREE
 : RELOCK
 :BALanced :RELOCK

[SOURce:] PHASe: ON

Description : This command sets the transition angle when the waveform shifts. The default is ON meaning 0 degree.
 Query Syntax : [SOURce :] PHASe : ON?
 Parameter : <NR2>, the valid range is 0.0 ~ 359.9.
 Return Parameter : <NR2>

[SOURce:] PHASe: OFF

Description : This command sets the transition angle when the waveform ends.
 Query Syntax : [SOURce :] PHASe : OFF?
 Parameter : <NR2>, the valid range is 0.0 ~ 360.0, 360.0: means IMMED.
 Return Parameter : <NR2>

[SOURce:]PHASe:P12

Description : This command sets the phase difference of $\Phi 1$ and $\Phi 2$.

Query Syntax : [SOURce :]PHASe:P12?
Parameter : <NR2>, the valid range is 0.0 ~ 359.9.
Return Parameter : <NR2>

[SOURce:]PHASe:P13

Description : This command sets the phase difference of $\Phi 1$ and $\Phi 3$.
Query Syntax : [SOURce :]PHASe:P13?
Parameter : <NR2>, the valid range is 0.0 ~ 359.9.
Return Parameter : <NR2>

[SOURce:]PHASe:SEQuence

Description : This command sets the phase sequence in 3-phase mode.
Query Syntax : [SOURce :]PHASe:SEQuence?
Parameter : POS | NEG
Return Parameter : POSITIVE | NEGATIVE

[SOURce:]PHASe:RELOCK

Description : This command sets the relock function in 3-phase mode.
Query Syntax : [SOURce :]PHASe:RELOCK?
Parameter : ENABLE | DISABLE
Return Parameter : ENABLE | DISABLE

[SOURce:]PHASe:THREE

Description : This command sets the operation mode in 3-phase mode.
Query Syntax : [SOURce :]PHASe:THREE?
Parameter : INDEPEND | SAMEFREQ | BALANCE
Return Parameter : INDEPEND | SAMEFREQ | BALANCE

[SOURce:]PHASe:THREE:BALanced

Description : This command sets the voltage operation mode in 3-phase balanced mode.
Query Syntax : [SOURce :]PHASe:THREE:BAL?
Parameter : PHASE | LINE

8.4.2.8 STATUS Sub-system

STATus

: OPERation
 [: EVENT]?
 : ENABle
: QUEStionable
 : CONDition
 [: EVENT]?
 : ENABle
 : NTRansition
 : PTRansition

STATus : OPERation [: EVENT]?

Description : This command queries the Operation Status register.
Query Syntax : STATus : OPERation [: EVENT]?
Parameter : None
Return Parameter : Always 0.

STATUS : OPERATION : ENABLE

Description : This command sets the Operation Status Enable register. The register is the shield when specific bit is enabled from Operation Status register.

Query Syntax : STATUS : OPERATION : ENABLE?

Parameter : <NR1>, the valid range is 0 ~ 255.

Return Parameter : Always 0.

STATUS : QUESTIONABLE : CONDITION?

Description : This query command returns the value of Questionable Condition register. It is a read only register that saves the questionable condition of Regenerative Grid Simulator in real time.

Query Syntax : STATUS : QUESTIONABLE : CONDITION?

Parameter : NONE

Return Parameter : <NR1>, the valid range is 0 ~ 511.

STATUS : QUESTIONABLE [: EVENT] ?

Description : This query command returns the value of Questionable Event register. It is a read only register that saves all items that passed Questionable NTR and/or PTR filter. If the QUES bit in Service Request Enabled register has been set and Questionable Event register > 0, the QUES of Status Byte register will be set too.

Query Syntax : STATUS : QUESTIONABLE [: EVENT]?

Parameter : NONE

Return Parameter : <NR1>, the valid range is 0 ~ 511.

STATUS : QUESTIONABLE : ENABLE

Description : The command sets or reads the value of Questionable Enable register. The register is the shield when specific bit is enabled to set the QUES bit of Status Byte register from Operation Status register.

Query Syntax : STATUS : QUESTIONABLE : ENABLE?

Parameter : <NR1>, the valid range is 0 ~ 511.

Return Parameter : <NR1>

STATUS : QUESTIONABLE : NTRANSITION

Description : These commands set or read the value of register. The operation of these registers is the same as polarity filter of Questionable Enable and Questionable Event registers that lead the following actions:

- * When a bit of the Questionable NTR register is set to 1, a 1-to-0 transition of the corresponding bit in the Questionable Condition register will make that bit in the Questionable Event register to be set.
- * When a bit of the Questionable PTR register is set to 1, a 0-to-1 transition of the corresponding bit in the Questionable Condition register will make that bit in the Questionable Event register to be set.
- * If the two same bits in both NTR and PTR registers are set to 0, none transition of that bit in the Questionable Condition register can set the corresponding bit in the Questionable Event register.

Bit Configuration of Questionable Status Register

Bit Position	15-9	8	7	6	5	4	3	2	1	0
Condition	---	OVP	INP	OCP	FAN	SHT	OTP	OPP		

OVP: Output voltage protection
 INP: Line input protection.
 OCP: Over current protection.
 FAN: Fan failure.
 SHT: Output short protection.
 OTP: Over temperature protection.
 OPP: Over power protection.

Query Syntax : STATus : QUESTionable : NTRansition?
 Parameter : <NR1>, the valid range is 0 ~ 511.
 Return Parameter : <NR1>

STATus : QUESTionable : PTRansition

Description : These commands set or read the values of Questionable PTR register. Please refer to the description of previous command.
 Query Syntax : STATus : QUESTionable : PTRansition?
 Parameter : <NR1>, the valid range is 0 ~ 511.
 Return Parameter : <NR1>

8.4.2.9 TRACE Sub-system

TRACe
 : RMS

TRACe
 Description : This command sets the user-defined waveform data. It needs 1024 data points to create a period of waveform. Users have to normalize the data and make the maximum point equal to 32767 or the minimum point equal to -32767.
 Syntax : TRACe <waveform_name>, <amplitude> {,<amplitude>}
 Parameter : <waveform_name>:US<n>, n=1~6, <amplitude>:<NR1>, the valid range is -32767 ~ 32767.
 Example : TRACe US1 100 200 ...32767... 500 800 <= 1024 points
 This command requires about 1 second for execution.

TRACe : RMS
 Description : This command sets the rms value of user's waveform. Users need to calculate the root mean square value for 1024 data points.
 Syntax : TRACe : RMS <waveform_name>, <rms>
 Parameter : <waveform_name>:US<n>, n=1~6, <rms>:<NR1>, the valid range is 0 ~ 32767.
 Example : TRACe : RMS US1 27000

8.4.2.10 LIST Sub-system

[SOURce:]

LIST

: COUPling
 :TRIG
 : POINts?
 : COUNT
 : DWELI
 : SHAPe
 : BASE
 : VOLTage
 : AC
 : START
 : END
 : DC
 : START
 : END
 : FREQuency
 : START
 : END
 : DEGRee

OUTPut

: MODE

TRIG

TRIG : STATE?

[SOURce:]LIST : COUPling

Description : This command sets the function of list mode.
 Query Syntax : [SOURce:] LIST : Coupling?
 Parameter : ALL | NONE
 Return Parameter : ALL | NONE

[SOURce:]LIST : TRIG

Description : This command sets the trigger type of list mode.
 Query Syntax : [SOURce:] LIST : TRIG?
 Parameter : AUTO | MANUAL|EXCITE
 Return Parameter : AUTO | MANUAL|EXCITE

[SOURce:] LIST : POINts?

Description : This command returns the valid order number of list mode.
 Query Syntax : [SOURce:] LIST : POINts?
 Parameter : None
 Return Parameter : <NR1>, the valid range is 0 ~ 100.

[SOURce :] LIST : COUNT

Description : This command sets the number of times the list executed before completion.
 Query Syntax : [SOURce :] LIST : COUNT?
 Parameter : <NR1>, the valid range is 0 ~ 65535.
 Return Parameter : <NR1>

[SOURce :] LIST : DWELI

Description : This command sets the sequence of dwell time list points.
Query Syntax : [SOURce:] LIST : DWELI?
Parameter : <NR2>, ..., <NR2>, the valid range is 0 ~ 99999999.9 (unit: ms.)
Return Parameter : <NR2>, ..., <NR2>

[SOURce :] LIST : SHAPe

Description : This command sets the sequence of waveform buffer list points.
Query Syntax : [SOURce:] LIST : SHAPe?
Parameter : A|B, ..., A|B
Return Parameter : A|B, ..., A|B

[SOURce :] LIST : BASE

Description : This command sets the time base of list.
Query Syntax : [SOURce:] LIST : BASE?
Parameter : TIME | CYCLE
Return Parameter : TIME | CYCLE

[SOURce :] LIST : VOLTage : AC : START

Description : This command sets the sequence of AC start voltage list points.
Query Syntax : [SOURce:] LIST : VOLTage : AC : START?
Parameter : <NR2>, ..., <NR2>, the valid range is 0.0 ~ 300.0.
Return Parameter : <NR1>, ..., <NR2>

[SOURce :] LIST : VOLTage : AC : END

Description : This command sets the sequence of AC end voltage list points.
Query Syntax : [SOURce:] LIST : VOLTage : AC : END?
Parameter : <NR2>, ..., <NR2>, the valid range is 0.0 ~ 300.0.
Return Parameter : <NR2>, ..., <NR2>

[SOURce :] LIST : VOLTage : DC : START

Description : This command sets the sequence of DC start voltage list points.
Query Syntax : [SOURce:] LIST : VOLTage : DC : START?
Parameter : <NR2>, ..., <NR2>, the valid range is -424.2 ~ 414.2.
Return Parameter : <NR1>

[SOURce :] LIST : VOLTage : DC : END

Description : This command sets the sequence of DC end voltage list points.
Query Syntax : [SOURce:] LIST : VOLTage : DC : START?
Parameter : <NR2>, ..., <NR2>, the valid range is -424.2 ~ 414.2.
Return Parameter : <NR2>, ..., <NR2>

[SOURce :] LIST : FREQuency : START

Description : This command sets the sequence of start frequency list points.
Query Syntax : [SOURce:] LIST : FREQuency : START?
Parameter : <NR2>, ..., <NR2>, the valid range is 15.00 ~ 100.00 (unit: Hz.)
Return Parameter : <NR2>, ..., <NR2>

[SOURce :] LIST : FREQuency : END

Description : This command sets the sequence of end frequency list points.
Query Syntax : [SOURce:] LIST : FREQuency : END?
Parameter : <NR2>, ..., <NR2>, the valid range is 15.0 ~ 100.00 (unit: Hz.)
Return Parameter : <NR2>, ..., <NR2>

[SOURce :] LIST : DEGRee

Description : This command sets the sequence of phase angle list points.
 Query Syntax : [SOURce:] LIST : DEGRee?
 Parameter : <NR2>, ..., <NR2>, the valid range is 0.0 ~ 359.9.
 Return Parameter : <NR2>, ..., <NR2>

OUTPut : MODE

Description : This command sets the operation mode.
 Query Syntax : OUTPut : MODE?
 Parameter : FIXED | LIST | PULSE | STEP | SYNTH | INTERHAR
 Return Parameter : FIXED | LIST | PULSE | STEP | SYNTH | INTERHAR

TRIG

Description : This command sets LIST mode in OFF, ON execution state after setting OUTPut: MODE LIST. If users wish to change the parameters, it's necessary to set TRIG OFF then OUTPut: MODE FIXED. Then, set OUTPut : MODE LIST again to get ready to set TRIG ON.
 Query Syntax : TRIG : STATE?
 Parameter : OFF | ON
 Return Parameter : OFF | RUNNING

8.4.2.11 PULSE Sub-system**[SOURce :]****PULSe**

: VOLTage
 : AC
 : DC
 : FREQuency
 : SHAPe
 : SPHase
 : COUNT
 : DCYCLE
 : PERiod
 : TRIG

OUTPut

: MODE

TRIG**TRIG : STATE?****[SOURce :] PULSe : VOLTage : AC**

Description : This command sets AC voltage for the duty cycle of PULSE mode.
 Query Syntax : [SOURce :] PULSE : VOLTage : AC?
 Parameter : <NR2>, the valid range is 0.0 ~ 300.0.
 Return Parameter : <NR2>

[SOURce :] PULSe : VOLTage : DC

Description : This command sets the DC voltage for the duty cycle of PULSE mode.

Query Syntax : [SOURce :] PULSE : VOLTage : DC?
Parameter : <NR2>, the valid range is -424.2 ~ 424.2.
Return Parameter : <NR2>

[SOURce :] PULSe : FREQuency

Description : This command sets the frequency for the duty cycle of PULSE mode.
Query Syntax : [SOURce :] PULSE : FREQuency?
Parameter : <NR2>, the valid range is 15.0 ~ 100.00 (unit: Hz.)
Return Parameter : <NR2>

[SOURce :] PULSe : SHAPe

Description : This command selects the waveform buffer for PULSE mode.
Query Syntax : [SOURce :] PULSE : SHAPe?
Parameter : A | B
Return Parameter : A | B

[SOURce :] PULSe : SPHase

Description : This command sets the start phase angle of duty cycle for PULSE mode.
Query Syntax : [SOURce :] PULSE : SPHase?
Parameter : <NR2>, the valid range is 0.0 ~ 359.9.
Return Parameter : <NR2>

[SOURce :] PULSe : COUNT

Description : This command sets the number of times the pulse executed before completion.
Query Syntax : [SOURce :] PULSE : COUNT?
Parameter : <NR2>, the valid range is 0 ~ 65535.
Return Parameter : <NR2>

[SOURce :] PULSe : DCYClE

Description : This command sets the duty cycle of PULSE mode.
Query Syntax : [SOURce :] PULSE : DCYClE?
Parameter : <NR2>, the valid range is 0 % ~ 100 %.
Return Parameter : <NR2>

[SOURce :] PULSe : PERiod

Description : This command sets the period of the PULSE mode.
Query Syntax : [SOURce :] PULSE : PERiod?
Parameter : <NR2>, the valid range is 0 ~ 99999999.9 (unit: ms.)
Return Parameter : <NR2>

[SOURce:]PULSe : TRIG

Description : This command sets the TRIG type of PULSE mode.
Query Syntax : [SOURce:] PULSe : TRIG?
Parameter : AUTO | MANUAL|EXCITE
Return Parameter : AUTO | MANUAL|EXCITE

OUTPut : MODE

Description : This command sets the operation mode.
Query Syntax : OUTPut : MODE?
Parameter : FIXED | LIST | PULSE | STEP | SYNTH | INTERHAR
Return Parameter : FIXED | LIST | PULSE | STEP | SYNTH | INTERHAR

TRIG

Description : This command sets PULSE mode in OFF execution state after setting OUTPUT : MODE PULSE. If users want to change the parameters, it's necessary to set TRIG OFF then OUTPUT : MODE FIXED. Then, set OUTPUT : MODE PULSE again to get ready to set TRIG ON.

Query Syntax : TRIG : STATE?

Parameter : OFF | ON

Return Parameter : OFF | RUNNING

8.4.2.12 STEP Sub-system**[SOURCE:]****STEP**

: VOLTage
 : AC
 : DC

: FREQuency
 : SHAPe
 : SPHase
 : DVOLTage
 : AC
 : DC

: DFRequency
 : DWELI
 : COUNT
 : TRIG

OUTPUT

: MODE

TRIG**TRIG: STATE?****[SOURCE :] STEP : VOLTage : AC**

Description : This command sets the initial AC voltage of STEP mode.

Query Syntax : [SOURCE :] STEP : VOLTage : AC?

Parameter : <NR2>, the valid range is 0.0 ~ 300.0.

Return Parameter : <NR2>

[SOURCE :] STEP : VOLTage : DC

Description : This command sets the initial DC voltage of STEP mode.

Query Syntax : [SOURCE :] STEP : VOLTage : DC?

Parameter : <NR2>, the valid range is -424.2 ~ 424.2.

Return Parameter : <NR2>

[SOURCE :] STEP : FREQuency

Description : This command sets the initial frequency of STEP mode.

Query Syntax : [SOURCE :] STEP : FREQuency?

Parameter : <NR2>, the valid range is 15.0 ~ 100.00 (unit: Hz.)

Return Parameter : <NR2>

[SOURce :] STEP : SHAPe

Description : This command selects the waveform buffer of STEP mode.
Query Syntax : [SOURce :] STEP : SHAPe?
Parameter : A | B
Return Parameter: A | B

[SOURce :] STEP : SPHase

Description : This command sets the start phase angle of STEP mode.
Query Syntax : [SOURce :] STEP : SPHase?
Parameter : <NR2>, the valid range is 0.0 ~ 359.9.
Return Parameter: <NR2>

[SOURce :] STEP : DVOLTage : AC

Description : This command sets the AC voltage change in each step.
Query Syntax : [SOURce :] STEP : DVOLTage : AC?
Parameter : <NR2>, the valid range is -300.0 ~ 300.0.
Return Parameter: <NR2>

[SOURce :] STEP : DVOLTage : DC

Description : This command sets the DC voltage change in each step.
Query Syntax : [SOURce :] STEP : DVOLTage : DC?
Parameter : <NR2>, the valid range is -424.2 ~ 424.2.
Return Parameter: <NR2>

[SOURce :] STEP : DFRequency

Description : This command sets the frequency change in each step.
Query Syntax : [SOURce :] STEP : DFRequency?
Parameter : <NR2>, the valid range is -100.00 ~ 100.00 (unit: Hz.)
Return Parameter: <NR2>

[SOURce :] STEP : DWELI

Description : This command sets the dwell time in each step.
Query Syntax : [SOURce :] STEP : DWELI?
Parameter : <NR2>, the valid range is 0 ~ 99999999.9 (unit: ms.)
Return Parameter: <NR2>

[SOURce :] STEP : COUNT

Description : This command sets the number of times the step executed before completion.
Query Syntax : [SOURce :] STEP : COUNT?
Parameter : <NR2>, the valid range is 0 ~ 65535.
Return Parameter: <NR2>

[SOURce:] STEP : TRIG

Description : This command sets the TRIP type of STEP mode.
Query Syntax : [SOURce:] STEP : TRIG?
Parameter : AUTO | MANUAL
Return Parameter: AUTO | MANUAL

OUTPut : MODE

Description : This command sets the operation mode.
Query Syntax : OUTPut : MODE?
Parameter : FIXED | LIST | PULSE | STEP | SYNTH | INTERHAR
Return Parameter: FIXED | LIST | PULSE | STEP | SYNTH | INTERHAR

TRIG

Description : This command sets STEP mode in OFF, ON execution state after setting OUTPUT : MODE STEP. If users want to change the parameters, it's necessary to set TRIG OFF then OUTPUT : MODE FIXED. Then, set OUTPUT : MODE STEP again to get ready to set TRIG ON.

Query Syntax : TRIG : STATE?

Parameter : OFF | ON

Return Parameter : OFF | RUNNING

8.4.2.13 SYNTHESIS Sub-system**[SOURCE:]****SYNThesis**

: COMPose

: AMPLitude

: PHASe

: FUNDamental

: DC

: FREQuency

: SPHase

OUTPut

: MODE

TRIG

TRIG: STATE?

[SOURCE :] SYNThesis : COMPose

Description : This command sets the data format of each harmonic order.
VALUE: absolute value, PERCENT: basic computer percentage.
Users can program 6 waveforms for execution.

Query Syntax : [SOURCE :] SYNThesis : COMPose?

Parameter : VALUE1 | VALUE2 | VALUE3 |
PERCENT1 | PERCENT2 | PERCENT3

Return Parameter: VALUE1 | VALUE2 | VALUE3 |
PERCENT1 | PERCENT2 | PERCENT3

[SOURCE :] SYNThesis : AMPLitude

Description : This command sets the amplitude of each harmonic order.
The maximum order is 50.

Query Syntax : [SOURCE :] SYNThesis : AMPLitude?

Parameter : <NR2>, ..., <NR2>
Valid range:

Order	Value	Percentage
2 ~ 10	0 ~ 90.0	0 ~ 30.00
11 ~ 20	0 ~ 60.0	0 ~ 20.00
21 ~ 30	0 ~ 30.0	0 ~ 10.00
31 ~ 40	0 ~ 30.0	0 ~ 10.00
41 ~ 50	0 ~ 15.0	0 ~ 5.00

Return Parameter : <NR2>, ..., <NR2>

[SOURCE :] SYNThesis : PHASe

Description : This command sets the phase angle of each harmonic order.
Query Syntax : [SOURCE :] SYNThesis : PHASe?
Parameter : <NR2>, ..., <NR2>, the valid range: 0.0 ~ 359.9
Return Parameter: <NR2>, ..., <NR2>

[SOURCE :] SYNThesis : FUNDamental

Description : This command sets the fundamental AC voltage in SYNTHESIS mode.
Query Syntax : [SOURCE :] SYNThesis : FUNDamental?
Parameter : <NR2>, the valid range: 0.0 ~ 300.0.
Return Parameter: <NR2>

[SOURCE :] SYNThesis : DC

Description : This command sets the DC voltage to add the voltage waveform in SYNTHESIS mode.
Query Syntax : [SOURCE :] SYNThesis : DC?
Parameter : <NR2>, the valid range: -424.2 ~ 424.2.
Return Parameter: <NR2>

[SOURCE :] SYNThesis : FREQuency

Description : This command sets the fundamental frequency in SYNTHESIS mode.
Query Syntax : [SOURCE :] SYNThesis : FREQuency?
Parameter : 50 | 60
Return Parameter: 50 | 60

[SOURCE :] SYNThesis : SPHase

Description : This command sets the start phase angle in SYNTHESIS mode.
Query Syntax : [SOURCE :] SYNThesis : SPHase?
Parameter : <NR2>, the valid range: 0.0 ~ 359.9
Return Parameter: <NR2>

OUTPut : MODE

Description : This command sets the operation mode. User should quit output before setting OUTPut : MODE SYNTH.
Query Syntax : OUTPut : MODE?
Parameter : FIXED | LIST | PULSE | STEP | SYNTH | INTERHAR
Return Parameter: FIXED | LIST | PULSE | STEP | SYNTH | INTERHAR

TRIG

Description : This command sets SYNTHESIS mode in OFF, ON execution state after setting OUTPut : MODE SYNTH. If users want to change the parameters, it's necessary to set TRIG OFF then OUTPut : MODE FIXED. Then, set OUTPut : MODE SYNTH again to get ready to set TRIG ON.
Query Syntax : TRIG : STATE?
Parameter : OFF | ON
Return Parameter: OFF | RUNNING

8.4.2.14 INTERHARMONICS Sub-system

[SOURce :]

INTERHARmonics

: FREQuency
 : START
 : END
 : LEVel
 : DWELI

OUTPut

: MODE

TRIG

TRIG : STATE?

FETCh | MEASure

: INTERHARmonics
 : FREQuency? It queries the sweeping frequency.

[SOURce :] INTERHARmonics : FREQuency : START

Description : This command sets the start frequency of sweep wave for INTERHARMONICS mode.

Query Syntax : [SOURce :] INTERharmonics : FREQuency : START?

Parameter : <NR2>, the valid range is 0.01 ~ 3000.0 (unit: Hz.)

Return Parameter : <NR2>

[SOURce :] INTERHARmonics: FREQuency : END

Description : This command sets the end frequency of sweep wave for INTERHARMONICS mode.

Query Syntax : [SOURce :] INTERharmonics : FREQuency : END?

Parameter : <NR2>, the valid range is 0.01 ~ 3000.00 (unit: Hz.)

Return Parameter : <NR2>

[SOURce :] INTERHARmonics: LEVel

Description : This command sets the rms. range of sweep wave in percentage level.

Query Syntax : [SOURce :] INTERharmonics : LEVEl?

Parameter : <NR2>, the valid range is 0% ~ 30% in 0.01 Hz ~ 500 Hz
 0% ~ 20% in 500.01 Hz ~ 1000 Hz
 0% ~ 10% in 1000.01 Hz ~ 2400 Hz
 0% ~ 5% in 2400.01 Hz ~ 3000 Hz

Return Parameter : <NR2>

[SOURce :] INTERHARmonics: DWELI

Description : This command sets the dwell time of sweep wave.

Query Syntax : [SOURce :] INTERharmonics : DWELI?

Parameter : <NR2>, the valid range is 0.00 ~ 99999.99 (unit: sec.)

Return Parameter : <NR2>

OUTPut : MODE

Description : This command sets the operation mode.

Query Syntax : OUTPut : MODE?

Parameter : FIXED | LIST | PULSE | STEP | SYNTH | INTERHAR

Return Parameter : FIXED | LIST | PULSE | STEP | SYNTH | INTERHAR

TRIG

Description : This command sets INTERHARMONICS mode in OFF, ON, PAUSE or CONTINUE execution state after setting OUTPut : MODE INTERHAR. If users wish to change the Parameter, it has to set TRIG OFF and OUTPut : MODE FIXED, next OUTPut : MODE INTERHAR in order to set TRIG ON.

Query Syntax : TRIG : STATE?

Parameter : OFF | ON | PAUSE | CONTINUE

Return Parameter : OFF | RUNNING | PAUSE

FETCH [:SCALAr] : INTERHARmonics: FREQUency?

MEASure [:SCALAr] : INTERHARmonics: FREQUency?

Description : These query commands return the sweep frequency stacked on base voltage.

Query Syntax : FETCH : INTERHARMonics : FREQUency?
MEASure : INTERHARMonics : FREQUency?

Return Parameter : <NR2>

8.4.2.15 Harmonic Sense Sub-system

[SOURce:]

CONFigure

: HARMonic
: SOURce
: TIMES
: PARAmeter
: FREQUency

SENSe

: HARMonic

FETCH | MEASure

[: SCALAr]

: HARMonic

: THD?

: FUNDamental?

: ARRAy?

It returns the % of total harmonic distortion.

It returns the fundamental frequency.

It returns the array of all harmonic orders.

[SOURce :] CONFigure : HARMonic : SOURce

Description : This command sets the measured power source in harmonic analysis mode.

Query Syntax : [SOURce :] CONFigure : HARMonic : SOURce?

Parameter : VOLT | CURR

Return Parameter : VOLT | CURR

[SOURce :] CONFigure : HARMonic : TIMES

Description : This command sets the way the measurement result of harmonic analysis displayed on LCD.

SINGLE: It keeps the measured data on the display when set.

CONTINUE: It updates the measured data on the display when set.

Query Syntax : [SOURce :] CONFigure : HARMonic : TIMes?

Parameter : SINGLE | CONTINUE
 Return Parameter: SINGLE | CONTINUE

[SOURce :] CONFigure : HARMonic : PARAmeter

Description : This command sets the data format for each harmonic order.
 Query Syntax : [SOURce :] CONFigure : HARMonic : PARAmeter?
 Parameter : VALUE | PERCENT
 Return Parameter: VALUE | PERCENT

[SOURce :] CONFigure : HARMonic : FREQuency

Description : This command sets the fundamental frequency of original waveform.
 Query Syntax : [SOURce :] CONFigure : HARMonic : FREQuency?
 Parameter : 50 | 60
 Return Parameter: 50 | 60

SENSe : HARMonic

Description : This command sets the harmonic measurement on/off. It has to execute "ON" before every new search or measurement. Only 3 seconds are required for the result. The parameter has to set to "OFF" if users wish to measure other data.
 Query Syntax : SENSe : HARMonic?
 Parameter : ON | OFF
 Return Parameter: ON | OFF

FETCh [:SCALar] : HARMonic : THD?

MEASure [:SCALar] : HARMonic : THD?

Description : This query command returns the % of total harmonic distortion.
 Query Syntax : FETCh : HARMonic : THD?
 MEASure : HARMonic : THD?
 Return Parameter: <NR2>

FETCh [:SCALar] : HARMonic : FUNDamental?

MEASure [:SCALar] : HARMonic : FUNDamental?

Description : This query command returns the fundamental frequency output current or voltage.
 Query Syntax : FETCh : HARMonic : FUNDamental?
 MEASure : HARMonic : FUNDamental?
 Return Parameter: <NR2>

FETCh [:SCALar] : HARMonic : ARRay?

MEASure [:SCALar] : HARMonic : ARRay?

Description : This query command returns the array of all harmonic orders.
 Query Syntax : FETCh : HARMonic : ARRay?
 MEASure : HARMonic : ARRay?
 Return Parameter: <NR2>

8.4.2.16 ACL Subsystem (Option)

LOAD:

```

:MODE
CCREctifier
  :CURRent
  :CREStfactor
CPREctifier
  : POWer
  :CREStfactor
CR
  :RESistor
CCPHase
  : CURRent
  :DEGRee
CPPHase
  :POWER
  :DEGRee
  :PF
  :MODE
PHASe
  :LIMit
    
```

LOAD: MODE

```

Description      : This command sets the ACL operating mode.
Query Syntax    : LOAD: MODE?
Parameter       : CCRE | CPRE | CR | CCPH | CPPH
Return Parameter : CCRE | CPRE | CR | CCPH | CPPH
    
```

LOAD: CCREctifier: CURRent

```

Description      : This command sets the loading current for CCREctifier mode.
Query Syntax    : LOAD: CCREctifier : CURRent?
Parameter       : <NR2>, valid range: 0.0 ~ 100.0 (unit: A)
Return Parameter : <NR2>
    
```

LOAD: CCREctifier: CRES

```

Description      : This command sets the current crest factor for CCREctifier mode.
Query Syntax    : LOAD: CCREctifier : CRES?
Parameter       : <NR2>, valid range: 1.414 ~ 3.000
Return Parameter : <NR2>
    
```

LOAD: CPREctifier: POWer

```

Description      : This command sets the loading power for CPREctifier mode.
Query Syntax    : LOAD: CPREctifier: POWer?
Parameter       : <NR2>, valid range: 10 ~ 20000 (unit: W)
Return Parameter : <NR2>
    
```

LOAD: CPREctifier: CRES

```

Description      : This command sets the current crest factor of loading power for
                  CPREctifier mode.
Query Syntax    : LOAD: CPREctifier: CRES?
Parameter       : <NR2>, valid range: 1.414 ~ 3.000
Return Parameter : <NR2>
    
```

LOAD: CR: RESistor

Description : This command sets the loading resistance value for CR mode.
 Query Syntax : LOAD: CR: RESistor?
 Parameter : <NR2>, valid range: 1 ~ 300 (unit: Ohm)
 Return Parameter : <NR2>

LOAD: CCPHase: CURRent

Description : This command sets the loading current for CCPHase mode.
 Query Syntax : LOAD: CCPHase: CURRent?
 Parameter : <NR2>, valid range: 0.0 ~ 100.0 (unit: A)
 Return Parameter : <NR2>

LOAD: CCPHase: DEGRee

Description : This command sets the phase difference between the loading current and the UUT voltage for CCPHase mode.
 Query Syntax : LOAD: CCPHase: DEGRee?
 Parameter : Phase Limit is ON :<NR2>, valid range: -90.0 ~ 90.0 (unit: Degree)
 Phase Limit is OFF :<NR2>, valid range: -180.0 ~ 180.0 (unit: Degree)
 Return Parameter : <NR2>

LOAD: CPPHase: POWer

Description : This command sets the loading power for CCPHase mode.
 Query Syntax : LOAD: CPPHase: POWer?
 Parameter : <NR2>, valid range: 10 ~ 20000 (unit: W)
 Return Parameter : <NR2>

LOAD: CPPHase: DEGRee

Description : This command sets the phase difference between the loading current and the UUT voltage for CPPHase mode.
 Query Syntax : LOAD: CPPHase: DEGRee?
 Parameter : Phase Limit is ON :<NR2>, valid range: -45.0 ~ 45.0 (unit: Degree)
 Phase Limit is OFF :<NR2>, valid range: 135.0 ~ 225.0 (unit: Degree)
 Return Parameter : <NR2>

LOAD: CPPHase: PF

Description : This command sets the PF value between the loading current of CPPHase mode and the UUT voltage. This setting is linked with LOAD: CCPHase: DEGRee.
 Query Syntax : LOAD: CPPHase: PF?
 Parameter : Valid range: 0.707~1
 Return Parameter : <NR2>

LOAD: CPPHase: PF: MODE

Description : This command sets the loading current of CPPHase mode ahead or behind the UUT voltage. This setting is linked with LOAD: CCPHase: DEGRee.
 Query Syntax : LOAD: CPPHase: PF: MODE?
 Parameter : LEAD | LAG
 Return Parameter : LEAD | LAG

LOAD:PHASe: LIMit

Description : This command sets the phase limit to be enabled or disabled.

Query Syntax : LOAD: PHASe: LIMit?
Parameter : ON | OFF
Return Parameter : ON | OFF

8.5 Command Summary

Common Commands

* CLS Clear status
* ESE<n> Enable standard event status
* ESE? Return enabled standard event status
* IDN? Return the Regenerative Grid Simulator ID
* RCL<n> Recall the Regenerative Grid Simulator file
* RST Reset the Regenerative Grid Simulator to initial states
* SAV<n> Save the Regenerative Grid Simulator status
* SRE Set request enable register
* STB? Return status byte
* TST? Return the self-test result of Regenerative Grid Simulator

Instrument Commands

SYSTEM

: ERRor?
: VERSion?
: LOCal
: REMote
: DATE
: TIME

INSTrument

: EDIT
: Couple
: NSElect
: SElect
: PHASe
: OPTION

FETCH | MEASure

[: SCALar]
: CURRent
: AC?
: DC?
: ACDC?
: AMPLitude:MAXimum?
: CREStfactor?
: INRush?
: FREQuency?
: POWer
: AC
[: REAL]?
: APParent?
: REACtive?

```

        : PFACTOR?
        : TOTAL?
        : TOTAL:APPARENT?
:VOLTage
    : AC?
    : DC?
    : ACDC?
    : AMPLitude:MAXimum?
:LINE
    :V12?
    :V23?
    :V31?

```

OUTPut

```

[: STATE]
: RELay
: SLEW
    : VOLTage
    : AC
    : DC
    : FREQency
: COUPLing
: MODE
: PROTECTION
: CLEAR

```

[SOURce:]

```

CURRENT
    : LIMIT
    : DELay
    : INRush
    : START
    : INTerval

```

```

FREQency
    [: {CW | IMMEDIATE}]
    : LIMIT

```

```

VOLTage
    [: LEVEL][: IMMEDIATE][: AMPLitude]
    : AC
    : DC
    : LIMIT
    : AC
    : DC
    : PLUS
    : MINus

```

```

POWER
    : PROTECTION

```

```

FUNCTION
    : SHAPE
    : SHAPE

```

: A
: A
: MODE
: THD
: AMP
: B
: B
: MODE
: THD
: AMP

LIST

: Coupling
: TRIG
: POINTs?
: COUNT
: DWELI
: SHAPe
: BASE
: VOLTage
: AC
: START
: END
: DC
: START
: END
: FREQuency
: START
: END
: DEGRee
PULSe
: VOLTage
: AC
: DC
: FREQuency
: SHAPe
: SPHase
: COUNT
: DCYCLE
: PERiod

STEP

: VOLTage
: AC
: DC
: FREQuency
: SHAPe
: SPHase
: DVOLTage
: AC
: DC
: DFREquency
: DWELI
: COUNT

SYNThesis

: COMPose
: AMPLitude
: PHASe
: FUNDamental
: DC
: FREQuency
: SPHase

INTERHARrmonics

: FREQuency
: START
: END
: LEVEl
: DWELl
: MODe

[SOURce:]

PHASe
: ON
: OFF

[SOURce:]

CONFigure
: INHibit

STATus

: OPERation
[: EVENt]?
: ENABle
: QUEStionable
: CONDition
[: EVENt]?
: ENABle
: NTRansition
: PTRansition

TRACe

: RMS

TRIG

TRIG: STATE?

Appendix A TTL Signal Pin Assignments

Green terminal with female connector:

Pin No.	Signal	Description
1	Ext-V Φ 1	Φ 1 External-V Reference signal input (-10V~10V)
2	Ext-V Φ 2	Φ 2 External-V Reference signal input (-10V~10V) This is the input pin of external voltage signal for single phase use.
3	Ext-V Φ 3	Φ 3 External-V Reference signal input (-10V~10V)
4	AGND	External-V Reference signal grounding
5	+12V	12V voltage output (providing current 1A)
6	Reserved	
7	DGND	Digital signal grounding
8	DGND	Digital signal grounding
9	AC-ON	This pin turns to HIGH when the Regenerative Grid Simulator outputs voltage and turns to LOW when quits output.
10	/ FAULT-OUT	The voltage level of this pin is HIGH when the Regenerative Grid Simulator is in normal mode, it will turn to LOW when the Regenerative Grid Simulator is in protection mode.
11	/ Ext-ONOFF	When EXT-ONOFF is enabled and the voltage level of this pin turns to LOW, the Regenerative Grid Simulator output will be open and it will close on the contrary.
12	/ Remote-Inhibit	When the voltage level of this pin turns to LOW, it can inhibit the Regenerative Grid Simulator output or trigger mode.
13	/Remote-Excite	When this pin receives a negative edge signal (from High to Low), it can trigger the transient output of Regenerative Grid Simulator.
14	/Transient	When the output of Regenerative Grid Simulator changes, this pin will send out a low level 64us or remain at high level.
15	Reserved	
16	Reserved	
17	Reserved	
18	Reserved	

Appendix B Built-in DST Waveform

The ratios of all built-in waveforms' steps are measured under no load.

Waveform A = DST01



N	%	D
5	9.80	0
7	15.80	0
8	2.16	0

DST01

Waveform A = DST02

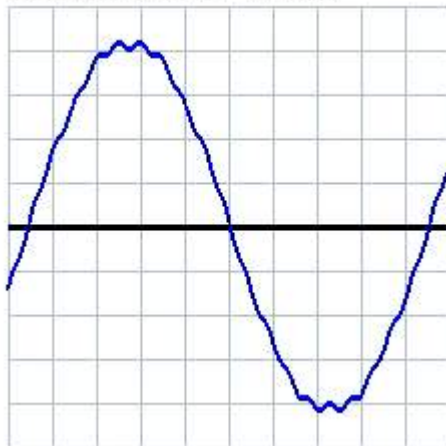

N	%	D
3	1.50	0
7	1.50	0
19	2.00	0

DST02

Waveform A = DST03

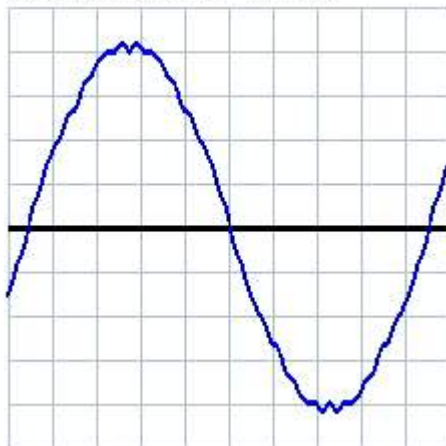

N	%	D
3	2.00	0
5	1.40	0
7	2.00	0
23	1.40	0
31	1.00	0

DST03

Waveform A = DST04

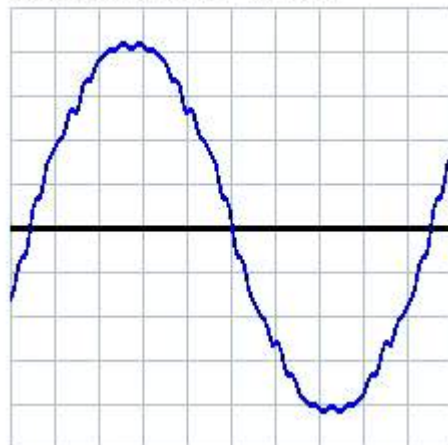

N	%	D
3	2.50	0
5	1.90	0
7	2.50	0
23	1.90	0
25	1.10	0
31	1.50	0
33	1.10	0

DST04

Waveform A = DST05

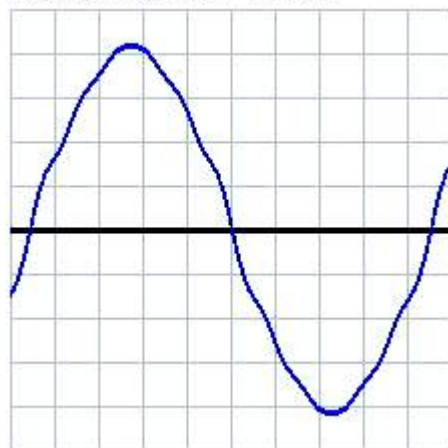

N	%	D
3	1.10	0
5	2.80	0
7	1.40	0
9	2.30	0
11	1.50	0

DST05

Waveform A = DST06



N	%	D
3	1.65	0
5	4.20	0
7	3.45	0
15	1.05	0
19	3.00	0

DST06

Waveform A = DST07

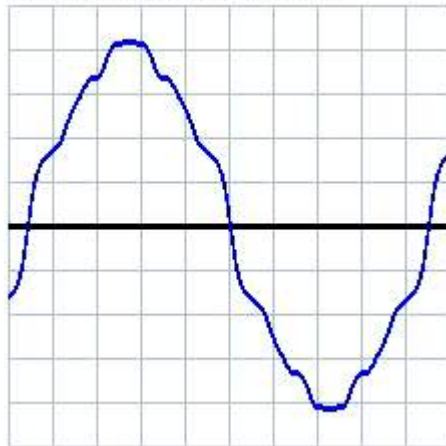

N	%	D
3	2.20	0
5	5.60	0
7	2.80	0
9	4.60	0
11	3.00	0
15	1.40	0
21	1.00	0

DST07

Waveform A = DST08

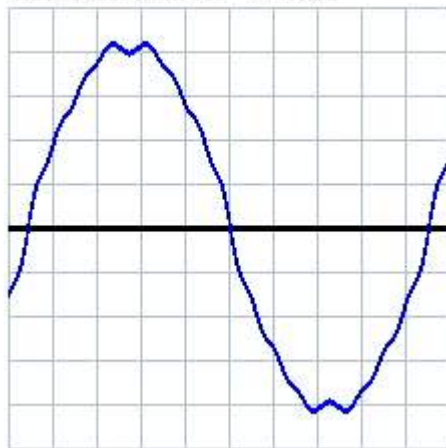

N	%	D
3	4.90	0
5	1.60	0
7	2.70	0
11	1.40	0
15	2.00	0
17	1.10	0

DST08

Waveform A = DST09

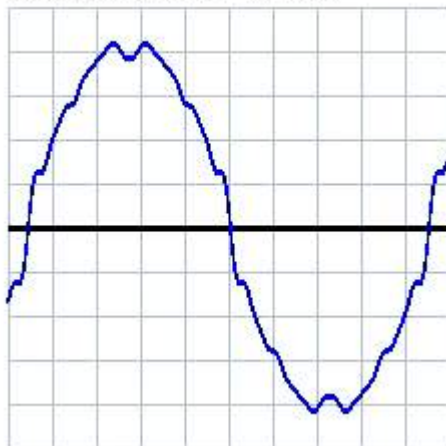

N	%	D	N	%	D
3	7.35	0	23	1.20	0
5	2.40	0	25	1.05	0
7	4.05	0			
11	2.10	0			
13	1.05	0			
15	3.00	0			
17	1.65	0			
19	1.05	0			
21	1.05	0			

DST09

Waveform A = DST10

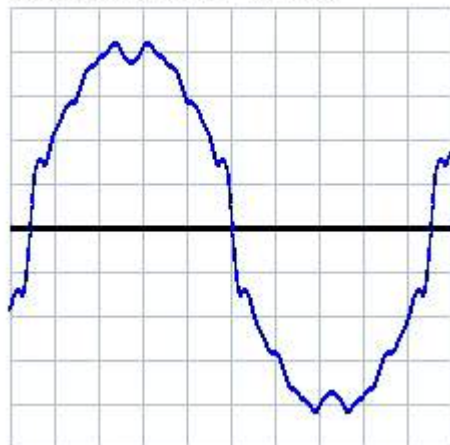

N	%	D	N	%	D
3	9.80	0	21	1.40	0
5	3.20	0	23	1.60	0
7	5.40	0	25	1.40	0
9	1.20	0			
11	2.80	0			
13	1.40	0			
15	4.00	0			
17	2.20	0			
19	1.40	0			

DST10

Waveform A = DST11



N	%	D
3	17.75	0

DST11

Waveform A = DST12

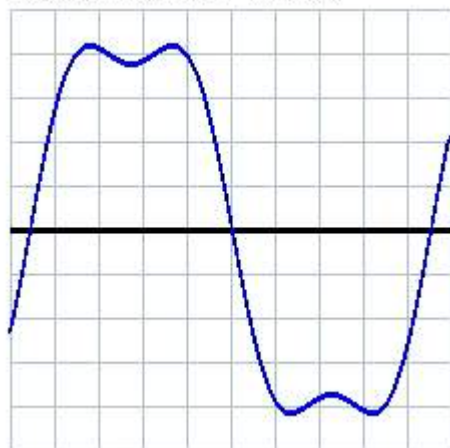

N	%	D
3	21.25	0

DST12

Waveform A = DST13

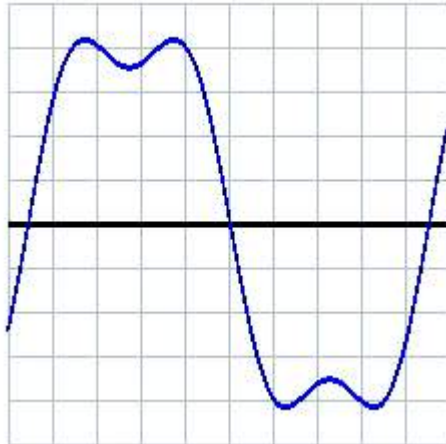

N	%	D
3	24.50	0

DST13

Waveform A = DST14



N	%	D
2	2.30	0
5	9.80	0
7	15.80	0
8	2.50	0

DST14

Waveform A = DST15

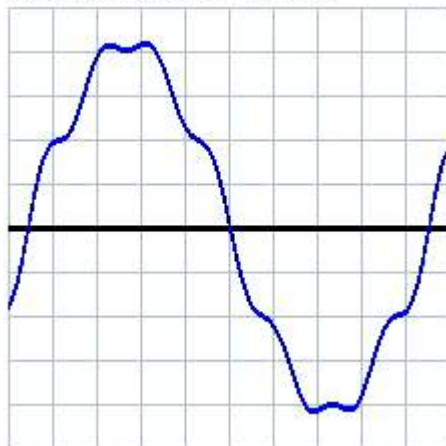

N	%	D
2	1.15	0
5	4.90	0
7	7.90	0
8	1.25	0

DST15

Waveform A = DST16

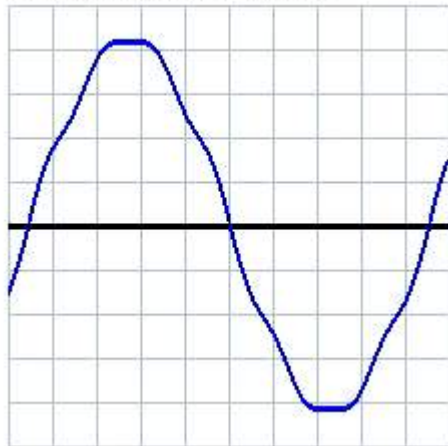

N	%	D
5	2.45	0
7	3.95	0

DST16

Waveform A = DST17

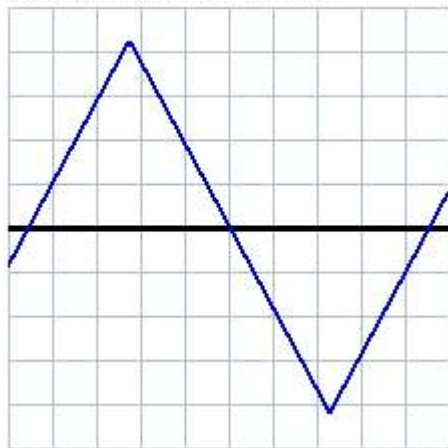

N	%	D	N	%	D
3	11.11	180	21	0.23	0
5	4.00	0	23	0.19	180
7	2.04	180	25	0.16	0
9	1.23	0	27	0.14	180
11	0.83	180			
13	0.59	0			
15	0.44	180			
17	0.35	0			
19	0.28	180			

DST17

Waveform A = DST18

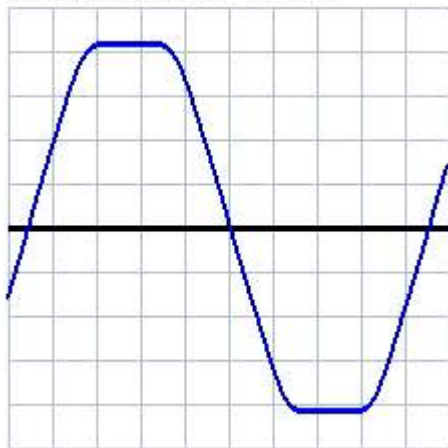

N	%	D
3	7.17	0
5	3.42	180
9	0.80	0

DST18

Waveform A = DST19

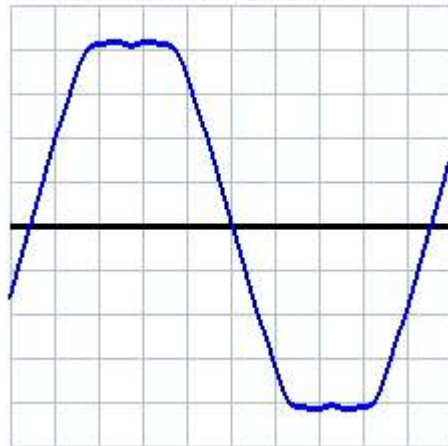

N	%	D
3	8.07	0
5	3.55	180
9	0.96	0
13	0.92	180

DST19

Waveform A = DST20

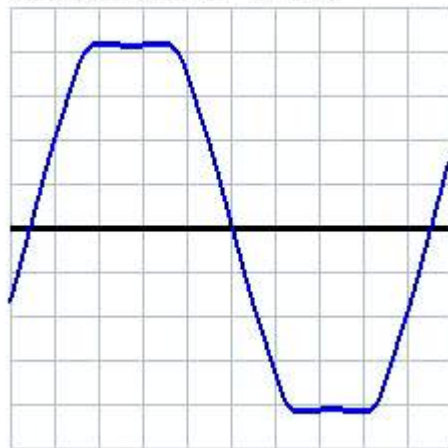

N	%	D
3	9.38	0
5	3.44	180
9	1.12	0
13	0.50	180

DST20

Waveform A = DST21

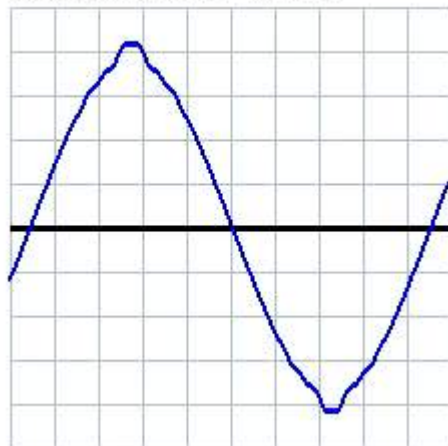

N	%	D
3	2.06	180
5	1.77	0
7	1.62	180
9	1.23	0
11	0.91	180
13	0.54	0
23	0.51	0
25	0.53	180

DST21

Waveform A = DST22

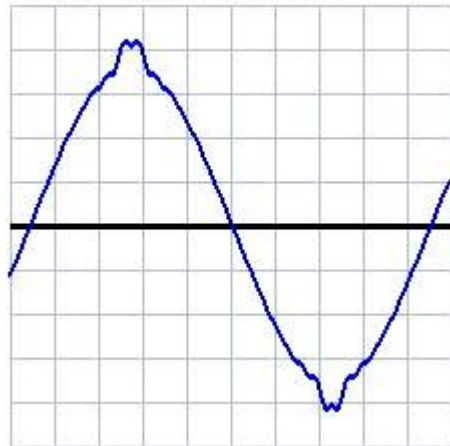

N	%	D	N	%	D
3	3.08	180	27	0.69	0
5	2.72	0	29	0.56	180
7	2.43	180			
9	1.97	0			
11	1.41	180			
13	0.86	0			
21	0.62	180			
23	0.73	0			
25	0.77	180			

DST22

Waveform A = DST23



N	%	D	N	%	D
3	4.28	180	23	0.97	0
5	3.77	0	25	1.04	180
7	3.27	180	29	0.75	180
9	2.57	0			
11	1.93	180			
13	1.22	0			
15	0.55	180			
19	0.46	0			
21	0.83	180			

DST23

Waveform A = DST24

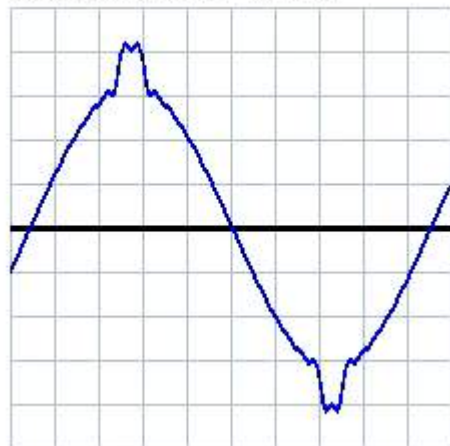

N	%	D	N	%	D
3	5.74	180	23	1.28	0
5	5.11	0	25	1.35	180
7	4.44	180	27	1.22	0
9	3.52	0	29	0.98	180
11	2.63	180			
13	1.65	0			
15	0.80	180			
19	0.61	0			
21	1.07	180			

DST24

Waveform A = DST25

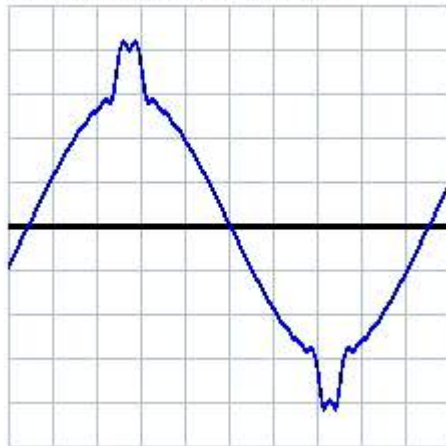

N	%	D	N	%	D
3	7.35	180	23	1.64	0
5	6.60	0	25	1.73	180
7	5.74	180	27	1.56	0
9	4.57	0	29	1.24	180
11	3.41	180			
13	2.16	0			
15	1.04	180			
19	0.74	0			
21	1.35	180			

DST25

Waveform A = DST26

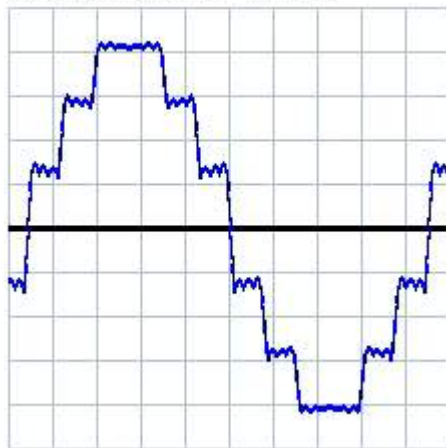

N	%	D	N	%	D
5	3.41	0	35	2.34	0
7	2.55	0	37	2.21	0
11	9.22	0			
13	7.68	0			
17	0.90	0			
19	0.90	0			
23	3.88	0			
25	3.56	0			
31	0.50	0			

DST26

Waveform A = DST27

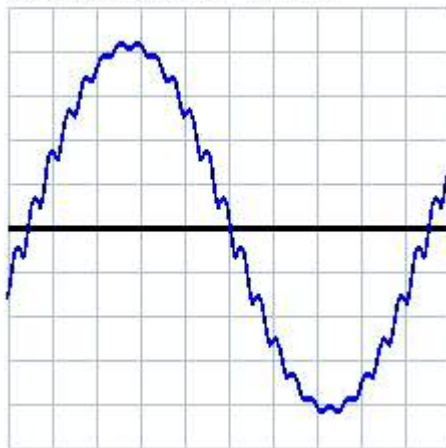

N	%	D
21	1.24	0
23	4.91	0
25	2.21	0

DST27

Waveform A = DST28

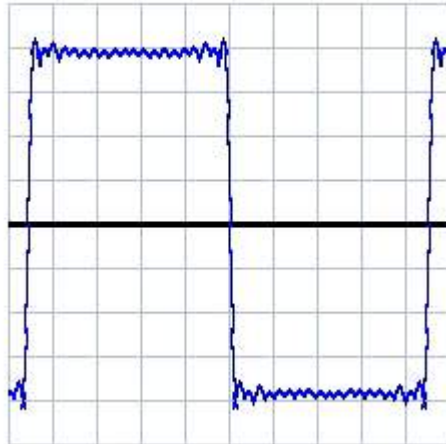

N	%	D	N	%	D
3	33.39	0	21	4.52	0
5	20.01	0	23	4.00	0
7	13.76	0	25	3.49	0
9	10.70	0	27	2.91	0
11	8.39	0	29	2.45	0
13	7.06	0	31	1.94	0
15	5.85	0	33	1.95	0
17	4.86	0	35	1.91	0
19	4.86	0	37	1.89	0
			39	1.83	0

DST28

Waveform A = DST29

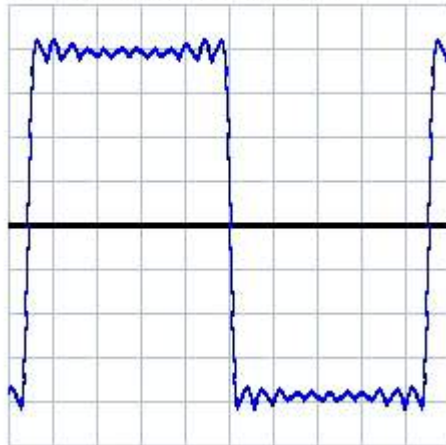

N	%	D	N	%	D
3	33.39	0	21	4.48	0
5	20.01	0	23	3.93	0
7	13.75	0	25	0.89	0
9	10.70	0	27	0.92	0
11	8.37	0	29	0.94	0
13	7.05	0	31	0.94	0
15	5.84	0	33	0.94	0
17	4.84	0	35	0.93	0
19	4.83	0	37	0.92	0
			39	0.91	0

DST29

Waveform A = DST30

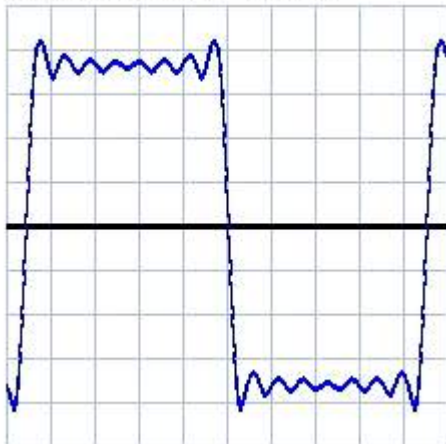

N	%	D
3	33.39	0
5	20.01	0
7	13.75	0
9	10.70	0
11	8.33	0
13	6.99	0
15	5.26	0

DST30

Chroma's Continuous Quality Process User Manual Customer Feedback

Chroma welcomes all comments and recommendations to improve this publication in the future editions. Please scan the QR code below or click the URL <http://www.chromaate.com/survey?n=793ce6db-17ef-4cd3-b0de-8bbd09aa38e0> to fill in the customer feedback form. Thank you!





CHROMA ATE INC.

致茂電子股份有限公司

66 Huaya 1st Road, Guishan,

Taoyuan 33383, Taiwan

台灣桃園市 33383 龜山區

華亞一路 66 號

T +886-3-327-9999

F +886-3-327-8898

Mail: info@chromaate.com

<http://www.chromaate.com>

All other trade names referenced are the properties of their respective companies.