

User's Manual

Regenerative DC Electronic Load 63700 Series

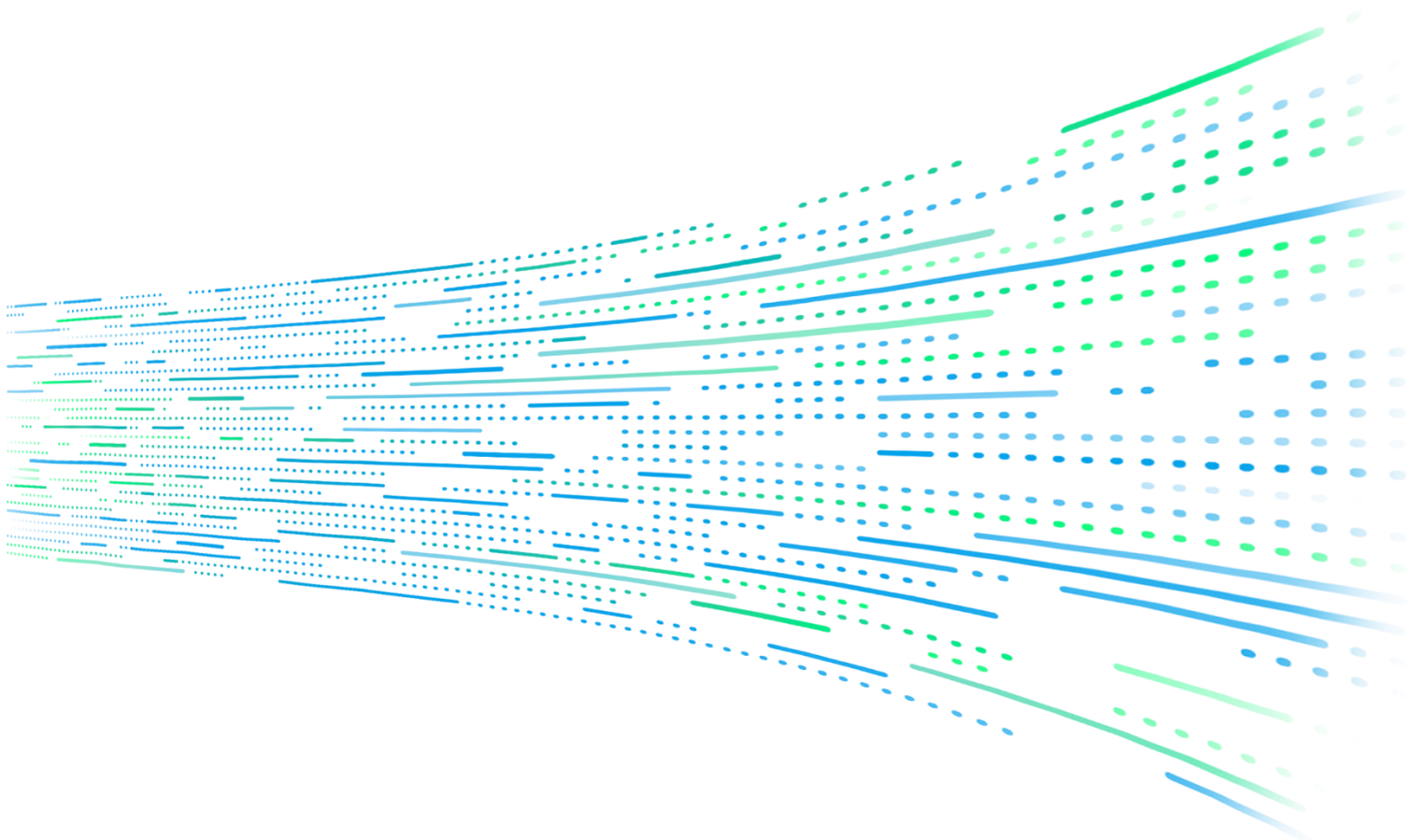

Get more product & global distributor information in Chroma ATE APP



Regenerative DC Electronic Load 63700 Series Operating and Programming Manual

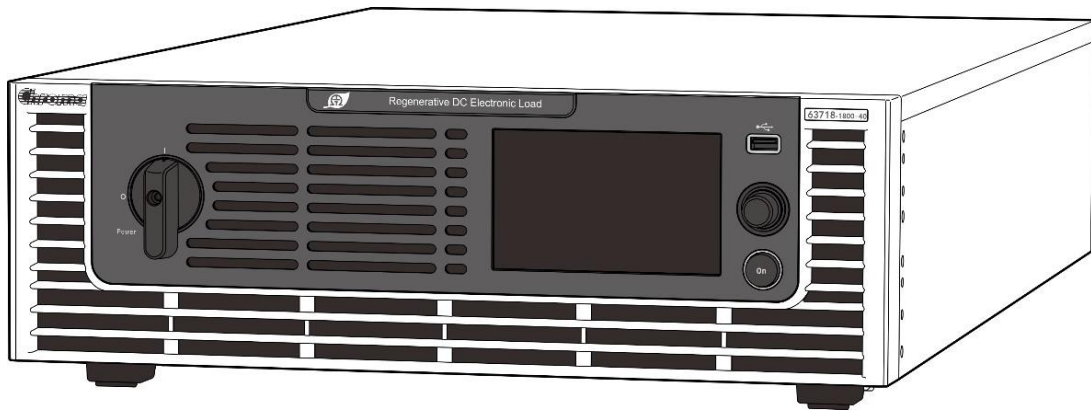

Version 1.2
April 2024

Legal Notices

The information in this document is subject to change without notice.

Chroma ATE INC. makes no warranty of any kind with regard to this manual, including, but not limited to, the implied warranties of merchantability and fitness for a particular purpose. Chroma ATE INC. shall not be held liable for errors contained herein or direct, indirect, special, incidental, or consequential damages in connection with the furnishing, performance, or use of this material.

CHROMA ATE INC.

88 Wenmao Rd., Guishan Dist., Taoyuan City 333001, Taiwan

Copyright Notices. Copyright 2022 Chroma ATE INC., all rights reserved. Reproduction, adaptation, or translation of this document without prior written permission is prohibited, except as allowed under the copyright laws.

Warranty

All of Chroma's instruments are warranted against defects in material and workmanship for a period of one year from the date of shipment. Chroma agrees to repair or replace any assembly or component found to be defective, under normal use during this period.

Chroma's obligation under this warranty is limited solely to repairing any such instrument, which in Chroma's sole opinion proves to be defective within the scope of the warranty when returned to the factory or to an authorized service center. Purchaser is responsible for the shipping and cost of the service item to Chroma factory or service center. Shipment should not be made without prior authorization by Chroma.

This warranty does not apply to any products repaired or altered by persons not authorized by Chroma, or not in accordance with instructions furnished by Chroma. If the instrument is defective as a result of misuse, improper repair, or abnormal conditions or operations, repairs will be billed at cost.

Chroma assumes no responsibility for its product being used in a hazardous or dangerous manner either alone or in conjunction with other equipment. High voltage used in some instruments may be dangerous if misused. Special disclaimers apply to these instruments. Chroma assumes no liability for secondary charges or consequential damages and in any event, Chroma's liability for breach of warranty under any contract or otherwise, shall not exceed the purchase price of the specific instrument shipped and against which a claim is made.

Any recommendations made by Chroma regarding the use of its products are based upon tests believed to be reliable; Chroma makes no warranty of the results to be obtained. This warranty is in lieu of all other warranties, expressed or implied, and no representative or person is authorized to represent or assume for Chroma any liability in connection with the sale of our products other than set forth herein.

Chroma undertakes no liability for any special or consequential damages, or any of our customer's compensation responsibilities to third parties, arising from use or access of our product.

CHROMA ATE INC.

88 Wenmao Rd., Guishan Dist.

Taoyuan City 333001, Taiwan

Tel: 886-3-327-9999

Fax: 886-3-327-8898

e-mail: info@chromaate.com

www.chromaate.com



**Ihr Ansprechpartner /
Your Partner:**

dataTec AG

E-Mail: info@datatec.eu

datatec.eu

Mess- und Prüftechnik. Die Experten.

Material Contents Declaration

The recycling label shown on the product indicates the Hazardous Substances contained in the product as the table listed below.

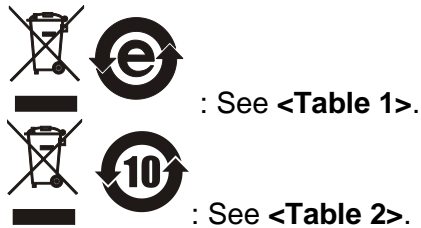

<Table 1>

Part Name	Hazardous Substances					
	Lead	Mercury	Cadmium	Hexavalent Chromium	Polybrominated Biphenyls/ Polybromodiphenyl Ethers	Selected Phthalates Group
	Pb	Hg	Cd	Cr ⁶⁺	PBB/PBDE	DEHP/BBP/DBP/DIBP
PCBA	○	○	○	○	○	○
CHASSIS	○	○	○	○	○	○
ACCESSORY	○	○	○	○	○	○
PACKAGE	○	○	○	○	○	○

“○” indicates that the level of the specified chemical substance is less than the threshold level specified in the standards of SJ/T-11363-2006, EU Directive 2011/65/EU, and 2015/863/EU.

“×” indicates that the level of the specified chemical substance exceeds the threshold level specified in the standards of SJ/T-11363-2006, EU Directive 2011/65/EU, and 2015/863/EU.

Remarks:

1. The CE marking on the product is a declaration of product compliance with EU Directive 2011/65/EU and 2015/863/EU.
2. This product complies with EU REACH regulations and no SVHC is in use.

Disposal

Do not dispose of electrical appliances as unsorted municipal waste, use separate collection facilities. Contact your local government for information regarding the collection systems available. If electrical appliances are disposed of in landfills or dumps, hazardous substances can leak into the groundwater and get into the food chain, damaging your health and well-being. When replacing old appliances with new ones, the retailer is legally obligated to take back your old appliances for disposal at least free of charge.



<Table 2>

Part Name	Hazardous Substances					
	Lead	Mercury	Cadmium	Hexavalent Chromium	Polybrominated Biphenyls/ Polybromodiphenyl Ethers	Selected Phthalates Group
	Pb	Hg	Cd	Cr ⁶⁺	PBB/PBDE	DEHP/BBP/DBP/DIBP
PCBA	×	○	○	○	○	○
CHASSIS	×	○	○	○	○	○
ACCESSORY	×	○	○	○	○	○
PACKAGE	○	○	○	○	○	○

“○” indicates that the level of the specified chemical substance is less than the threshold level specified in the standards of SJ/T-11363-2006, EU Directive 2011/65/EU, and 2015/863/EU.

“×” indicates that the level of the specified chemical substance exceeds the threshold level specified in the standards of SJ/T-11363-2006, EU Directive 2011/65/EU, and 2015/863/EU.

1. Chroma is not fully transitioned to lead-free solder assembly at this moment; however, most of the components used are RoHS compliant.
2. The environment-friendly usage period of the product is assumed under the operating environment specified in each product’s specification.
3. This product complies with EU REACH regulations and no SVHC is in use.

Disposal

Do not dispose of electrical appliances as unsorted municipal waste, use separate collection facilities. Contact your local government for information regarding the collection systems available. If electrical appliances are disposed of in landfills or dumps, hazardous substances can leak into the groundwater and get into the food chain, damaging your health and well-being. When replacing old appliances with new ones, the retailer is legally obligated to take back your old appliances for disposal at least free of charge.





Declaration of Conformity

For the following equipment :

Programmable Bidirectional DC Power Supply

(Product Name/ Trade Name)

62180D-600, 62120D-600, 62060D-600, A620037, 62180H-600P, 62120H-600P, 62060H-600P, 63718-600-120, 63712-600-80, 63706-600-40, A637002

(Model Designation)

Chroma ATE Inc.

(Manufacturer Name)

88 Wenmao Rd., Guishan Dist., Taoyuan City 333001, Taiwan

(Manufacturer Address)

Is herewith confirmed to comply with the requirements set out in the Council Directive on the Approximation of the Laws of the Member States relating to Electromagnetic Compatibility (2014/30/EU) and Low Voltage Directive (2014/35/EU). For the evaluation regarding the Directives, the following standards were applied :

EN 61326-1:2013 Class A, EN 61326-2-1:2013

EN 61000-3-12:2011, EN 61000-3-11:2000

EN 61326-1:2013 (industrial locations)

EN 61000-4-2:2009, EN 61000-4-3:2006+A1:2008+A2:2010,

EN 61000-4-4:2012, EN 61000-4-5:2014+A1:2017, EN 61000-4-6:2014,

EN 61000-4-8:2010, EN 61000-4-34:2007+A1:2009

IEC 61010-1:2010+A1:2016(Edition 3.1), EN 61010-1:2010+A1:2019

The equipment describe above is in conformity with Directive 2011/65/EU and 2015/863/EU of the European Parliament and of the Council on the restriction of the use of certain hazardous substances in electrical and electronic equipment.

The following importer/manufacturer or authorized representative established within the EUT is responsible for this declaration :

Chroma ATE Europe B.V.

(Authorized Representative Name)

Morsestraat 32, 6716 AH Ede, The Netherlands

(Authorized Representative Address)

Person responsible for this declaration:

Mr. Vincent Wu

(Name, Surname)

T&M BU/Vice President

(Position/Title)

Taiwan

(Place)

2021.10.15

(Date)

(Legal Signature)



Declaration of Conformity

For the following equipment :

Programmable Bidirectional DC Power Supply

(Product Name/ Trade Name)

62180D-1800, 62180D-1200, 62120D-1200, A620038, 62180H-1800P, 62120H-1200P, A620054, 63718-1800-40, 63712-1200-40, 63718-1200-40, A637003

(Model Designation)

Chroma ATE Inc.

(Manufacturer Name)

88 Wenmao Rd., Guishan Dist., Taoyuan City 333001, Taiwan

(Manufacturer Address)

Is herewith confirmed to comply with the requirements set out in the Council Directive on the Approximation of the Laws of the Member States relating to Electromagnetic Compatibility (2014/30/EU) and Low Voltage Directive (2014/35/EU). For the evaluation regarding the Directives, the following standards were applied :

EN 61326-1:2013 Class A, EN 61326-2-1:2013

EN 61000-3-12:2011, EN 61000-3-11:2000

EN 61326-1:2013 (industrial electromagnetic environment)

EN 61000-4-2:2009, EN 61000-4-3:2006+A1:2008+A2:2010,

EN 61000-4-4:2012, EN 61000-4-5:2014+A1:2017, EN 61000-4-6:2014,

EN 61000-4-8:2010, EN 61000-4-34:2007+A1:2009

IEC 61010-1:2010+A1:2016(Edition 3.1), EN 61010-1:2010+A1:2019

The equipment describe above is in conformity with Directive 2011/65/EU and 2015/863/EU of the European Parliament and of the Council on the restriction of the use of certain hazardous substances in electrical and electronic equipment.

The following importer/manufacturer or authorized representative established within the EUT is responsible for this declaration :

Chroma ATE Europe B.V.

(Authorized Representative Name)

Morsestraat 32, 6716 AH Ede, The Netherlands

(Authorized Representative Address)

Person responsible for this declaration:

Mr. Vincent Wu

(Name, Surname)

T&M BU/Vice President

(Position/Title)

Taiwan

(Place)

2021.10.15

(Date)

(Legal Signature)

Safety Summary

The following general safety precautions must be observed during all phases of operation, service, and repair of this product. Failure to comply with these precautions or specific WARNINGS given elsewhere in this manual will violate the safety standards of design, manufacture, and intended use of the instrument. *Chroma* assumes no liability for the customer's failure to comply with these requirements.



BEFORE APPLYING POWER

Verify that the power is set to match the rated input of this device.



PROTECTIVE GROUNDING

Make sure to connect the protective grounding to prevent an electric shock before turning on the power.

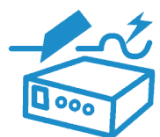

NECESSITY OF PROTECTIVE GROUNDING

Never cut off the internal or external protective grounding wire, or disconnect the wiring of the protective grounding terminal. Doing so will cause a potential shock hazard that may bring injury to a person.



FUSES

Only fuses with the required rated current, voltage, and specified type (normal blow, time delay, etc.) should be used. Do not use repaired fuses or short-circuited fuse holders. To do so could cause a shock or fire hazard.



DO NOT OPERATE IN AN EXPLOSIVE ATMOSPHERE

Do not operate the instrument in the presence of flammable gases or fumes. The instrument should be used in an environment of good ventilation.















DO NOT REMOVE THE COVER OF THE INSTRUMENT

Operating personnel must not remove the cover of the instrument. Component replacement and internal adjustment can be done only by qualified service personnel.

WARNING

When the voltage and current are set and outputting, the output terminal on the rear panel has dangerous voltage, touching it may result in death.

Safety Symbols

	DANGER – High voltage.
	Explanation: To avoid injury, death of personnel, or damage to the instrument, the operator must refer to the explanation in the manual.
	High temperature: This symbol indicates the temperature is hazardous. Do not touch to avoid personal injury.
	Protective grounding terminal: This symbol indicates that the terminal must be connected to the ground before operating the equipment to protect against electrical shock in case of a fault.
	Functional grounding: To identify an earth (ground) terminal in cases where the protective ground is not explicitly stated. This symbol indicates the power connector does not provide grounding.
	Frame or chassis: To identify a frame or chassis terminal.
	Alternating Current (AC)
	Direct Current (DC) / Alternating Current (AC)
	Direct Current (DC)
	Push-on/Push-off power switch
	The WARNING sign highlights an essential operating or maintenance procedure, practice, condition, statement, etc., which if not strictly observed, could result in injury to, or death of, personnel or long-term health hazards.
	The CAUTION sign highlights an essential operating or maintenance procedure, practice, condition, statement, etc., which if not strictly observed, could result in damage to, or destruction of, equipment.
	The Notice sign highlights an essential operating or maintenance procedure, condition, or statement.

Revision History

The following lists the additions and modifications in this manual at each revision.

Date	Version	Revised Sections
Dec. 2022	1.0	Complete this manual.
Oct. 2023	1.1	Modify the following: <ul style="list-style-type: none">- <i>“Introduction”</i> and <i>“Specifications”</i> in <i>“Overview”</i> chapter- <i>“Checking the Package”</i>, <i>“Common Environment Conditions”</i>, and <i>“Power on Procedure”</i> in <i>“Installation”</i> chapter- <i>“System Setup”</i>, <i>“Configuration”</i>, and <i>“Parallel”</i> in <i>“Manual Operation”</i> chapter- <i>“GPIB Function of 63700 Series”</i>, <i>“CONFIGURE Subsystem”</i>, and <i>“SYSTEM Subsystem”</i> in <i>“Remote Operation”</i> chapter- Appendix <i>“Analog Interface Pin Assignments”</i> and <i>“List of Protection”</i>
Apr. 2024	1.2	Add <i>“Sleep Mode”</i> and <i>“Fan Control”</i> in <i>“Manual Operation”</i> chapter. Modify the following: <ul style="list-style-type: none">- <i>“Specifications”</i> and <i>“Dimension”</i> in <i>“Overview”</i> chapter- <i>“Checking the Package”</i>, <i>“Ratings”</i>, <i>“Input Connection”</i>, <i>“Rear Panel Output”</i>, and <i>“Specification of Connecting Wire”</i> in <i>“Installation”</i> chapter- <i>“Appendix B List of Protection”</i> Add <i>“Precautions for Battery Test”</i> to appendix.

Table of Contents

1.	Overview	1-1
1.1	Introduction	1-1
1.2	System Functions	1-1
1.2.1	Operation Mode	1-1
1.2.2	Protection	1-1
1.2.3	Output and Indicators	1-1
1.2.4	Measuring and Editing	1-2
1.3	Specifications	1-2
1.4	Function Buttons	1-11
1.4.1	Front Panel	1-11
1.4.2	Rear Panel	1-12
1.5	Dimension	1-14
2.	Installation	2-1
2.1	Checking the Package	2-1
2.1.1	Maintenance and Cleaning	2-4
2.2	Preparation for Use	2-5
2.2.1	Common Environment Conditions	2-5
2.3	Requirements of Input Power	2-5
2.3.1	Ratings	2-5
2.3.2	Input Connection	2-6
2.4	Remote Sensing	2-8
2.4.1	Correct Connection	2-8
2.4.2	Reverse Connection of Remote Sensing Wire Polarity	2-9
2.5	Output Connection	2-10
2.5.1	Rear Panel Output	2-10
2.5.2	Specification of Connecting Wire	2-13
2.5.3	Installing the Handle	2-13
2.6	Power on Procedure	2-14
3.	Manual Operation	3-1
3.1	Introduction	3-1
3.2	Menu for Setup	3-1
3.2.1	Meas. & Setup	3-3
3.2.1.1	Constant Current (CC)	3-3
3.2.1.2	Constant Resistance (CR)	3-4
3.2.1.3	Constant Voltage (CV)	3-5
3.2.1.4	Constant Power (CP)	3-5
3.2.1.5	Constant Current Dynamic (CCD)	3-6
3.2.2	System Setup	3-7
3.2.2.1	System Information	3-7
3.2.2.2	Basic Setting	3-8
3.2.2.3	Protection	3-9
3.2.2.3.1	UUT OCP	3-10
3.2.2.3.2	UUT OPP	3-11
3.2.2.3.3	SAFETY INT.LOCK	3-11
3.2.2.4	Load Setting	3-13
3.2.2.5	Meas. Setting	3-14
3.2.2.6	Screenshot	3-16
3.2.2.7	Factory Default	3-17
3.2.2.8	Sleep Mode	3-18
3.2.2.9	Fan Control	3-18

3.2.3	Configuration.....	3-19
3.2.3.1	Interface	3-19
3.2.3.1.1	LAN.....	3-20
3.2.3.1.2	GPIB	3-22
3.2.3.1.3	CAN	3-22
3.2.3.1.4	USB.....	3-23
3.2.3.2	Parallel	3-24
3.2.3.2.1	Output Connection in Parallel	3-25
3.2.3.2.2	Installing Parallel Communication Interface	3-25
3.2.3.2.3	Setting Parallel Operation Mode	3-26
3.2.3.2.4	Parallel Mode Connection	3-27
4.	Remote Operation	4-1
4.1	Overview.....	4-1
4.1.1	USB Interface.....	4-1
4.1.2	Setting GPIB and Ethernet Parameters.....	4-1
4.1.3	Ethernet Remote Control.....	4-1
4.2	GPIB Function of 63700 Series.....	4-2
4.3	Introduction to Programming.....	4-2
4.3.1	Conventions	4-2
4.3.2	Numerical Data Formats.....	4-2
4.3.3	Boolean Data Format	4-3
4.3.4	Character Data Format.....	4-3
4.3.5	Basic Definition	4-3
4.3.5.1	Command Tree Structure	4-3
4.3.5.2	Program Headers	4-4
4.3.5.3	Common Command and Query Headers.....	4-4
4.3.5.4	Instrument-Controlled Headers.....	4-4
4.3.5.5	Program Header Separator (:)	4-4
4.3.5.6	Program Message	4-4
4.3.5.7	Program Message Unit.....	4-4
4.3.5.7.1	Program Message Unit Separator (;)	4-4
4.3.5.7.2	Program Message Terminator (<PMT>)	4-5
4.4	Traversal of Command Tree	4-5
4.5	Execution Order	4-5
4.6	Commands	4-5
4.6.1	Common Command Syntax	4-8
4.6.2	Specific Commands for 63700 Series.....	4-12
4.6.2.1	ABORT Subsystem	4-12
4.6.2.2	CONFIGURE Subsystem	4-12
4.6.2.3	MODE Subsystem	4-17
4.6.2.4	LOAD Subsystem.....	4-17
4.6.2.5	CURRENT Subsystem	4-18
4.6.2.6	RESISTANCE Subsystem.....	4-21
4.6.2.7	VOLTAGE Subsystem.....	4-22
4.6.2.8	POWER Subsystem	4-23
4.6.2.9	FETCH Subsystem.....	4-24
4.6.2.10	MEASURE Subsystem	4-25
4.6.2.11	SYSTEM Subsystem	4-25
4.6.2.12	INSTRUMENT Subsystem.....	4-29
5.	Self Test and Troubleshooting	5-1
5.1	Overview.....	5-1
5.2	Troubleshooting	5-1

Appendix A	Analog Interface Pin Assignments.....	A-1
Appendix B	List of Protection.....	B-1
Appendix C	Precautions for Battery Test.....	C-1

1. Overview

1.1 Introduction

The Chroma 63700 Series are high power density, regenerative DC electronic loads that have electronic load functions and regenerative load characteristics allowing energy feedback to the grid from UUT. They are suitable for testing modern energy storage systems, providing stable DC output and accurate measurement for regenerative power applications.

The features of 63700 Series Regenerative DC Electronic Loads are:

- (1) High power density output ➔ the maximum output power can be up to 18kW under 3U height.
- (2) 16-bit ADC/16-bit DAC ➔ provides excellent resolution for measurement and load.
- (3) Rotary knob control on the front panel ➔ to set the loading current and others.
- (4) Touch panel ➔ provides users with a high brightness and wide viewing angle interface for manual operation.
- (5) Via GPIB/CAN (option), USB, Ethernet, or APG (analog programmable interface) interface ➔ to do remote control.
- (6) Active PFC design ➔ PF value > 0.99 to improve the utilization of power distribution capacity and wiring.

1.2 System Functions

1.2.1 Operation Mode

- (1) Local operation is performed by the touch panel and rotary knob on the front panel.
- (2) The remote control is done via GPIB/CAN (option), USB, or Ethernet interface.

1.2.2 Protection

- (1) Protections for voltage phase loss, input over-voltage or under-voltage, output over-voltage, over-current, over-power, over-temperature, fan fail, CV/CC foldback, etc. are available.
- (2) Smart fan control: Turn the fan speed from low to high based on the device temperature, output current, and output power to reduce the audible noise.

1.2.3 Output and Indicators

- (1) Analog outputs are provided to monitor (V/I Monitor) output signals. This allows signals to be easily measured by external instruments (DMM, Oscilloscope, etc.). The analog monitoring points are stored in the buffer for protection
- (2) Load ON indicator signal.
- (3) Protection state indication (AD OCP/DD OCP/OPP/FAN LOCK/AC FAULT, etc.).
- (4) Over temperature (OTP) protection signal.

- (5) Load status indicators.

1.2.4 Measuring and Editing

- (1) The Electronic Load can measure the voltage, current, and power.
 (2) The Electronic Load is equipped with constant current (CC), constant resistance (CR), constant voltage (CV), constant power (CP), and dynamic constant current (CCD) operating modes.

1.3 Specifications

Chroma 63700 Series Regenerative DC Electronic Loads include 6kW (63706), 12kW (63712), and 18kW (63718) three types. Table 1-1 lists the specifications of these models. It is suggested to warm up the instruments for more than 10 minutes before performing verification tests. The test condition is $25 \pm 5^{\circ}\text{C}$ and under a resistance load.

Table 1-1 Specifications

Model	63706-100-180	63712-100-360	63718-100-540
Voltage ^{*2}	0-100V		
Current ^{*3}	0-180A	0-360A	0-540A
Power ^{*4}	6kW	12kW	18kW/22kW ^{*12}
Static mode			
Min. operating voltage (DC) ^{*5}	5V@180A	5V@360A	5V@540A
CC			
Range	0-180A	0-360A	0-540A
Resolution	10mA		
Accuracy	0.2%F.S.		
Ripple (rms)	<150mA	<300mA	<450mA
CR			
Range	0.1mΩ-240Ω	0.1mΩ-120Ω	0.1mΩ-80Ω
Resolution	10mA / Vsense		
Accuracy	Vin/Rset*(0.4%)+0.4% IF.S.		
CV			
Range	0-100V		
Resolution	10mV		
Accuracy	0.1%F.S.		
Ripple (P-P) ^{*6}	150mV		
Ripple (rms) ^{*6}	25mV		
CP			
Range	0-6,000W	0-12,000W	0-18,000W
Resolution	0.4W		
Accuracy ^{*7}	0.3%F.S.		
Dynamic mode			
T1 & T2	10ms-100s		
Resolution	1ms		
Accuracy	1ms+100ppm		
Slew rate ^{*8}	10mA/ms-10A/ms	10mA/ms-20A/ms	10mA/ms-30A/ms

Model	63706-100-180	63712-100-360	63718-100-540
Resolution	1mA/ms		
Accuracy	1% ± 2ms		
Min. rise time	2ms (Typical)		
Measurement			
Voltage read back			
Range	0-100V		
Resolution	10mV		
Accuracy	0.05%+0.05%F.S.		
Current read back			
Range	0-180A	0-360A	0-540A
Resolution	10mA		
Accuracy	0.1%+0.1%F.S.		
Power read back			
Range	0-6,000W	0-12,000W	0-18,000W/0-22,000W**11
Resolution	100mW		
Accuracy *7	0.2%+0.2%F.S.		
Monitor			
Voltage Monitor			
Bandwidth	20kHz		
Range	0-100V		
Output	0-10V		
Accuracy	0.5%F.S.		
Output impedance	10kΩ		
Resolution	4mV		
Current Monitor			
Bandwidth	20kHz		
Range	0-180A	0-360A	0-540A
Output	0-10V		
Accuracy	0.75%F.S.		
Output impedance	10kΩ		
Resolution	4mV		
Signal			
Signal Output			
LOAD ON status	Active "High" when the load is on, TTL		
ALARM status	Active "High" when an alarm is in progress, TTL		
SHORT status	Active "High" when the short is on, TTL		
RANGE status	N/A		
Digital output	Defined by users		
Signal Input			
External load on	To control load on/off externally		
Trigger sequence	To trigger the following sequence, TTL		
Digital input	Defined by users		
Protection			
DC Side			
Over Current	Yes (Settable)		
Over Power	Yes (Settable)		
Over Temperature	Yes		
Over Voltage Alarm	Yes		
Reverse Alarm	Yes		

Model	63706-100-180	63712-100-360	63718-100-540
Under Voltage	N/A		
AC Side			
Voltage Range Error	Out of the voltage range		
Frequency Range Error	Out of the 47Hz - 63Hz range		
Open Phase	When one of the three phases is missing		
Interface			
Front USB (Host)	Standard (Type A)		
Rear USB (Device)	Standard (Type B)		
GPIB	GPIB send command to DC Load receiver <20ms Under GPIB command using Measure <25ms		
Ethernet (LXI)	Standard		
RS232	Optional		
CAN	Optional Cycling time < 10ms		
System Bus	Master/Slave		
Control Setting Time (CC Mode)	<20ms from command sent till the load starts to change		
Measurement Response Time (For both V&I)	<10ms		
General			
HxWxD	133 x 428 x 730 mm / 5.23 x 16.85 x 28.74 inch		
Weight	29.6kg / 65.25lbs	37.5kg / 82.67lbs	45.4kg / 100.8lbs
Operating Temp	0-40°C		
Storage Temp	-25-70°C		
Line Voltage	3Φ 200Vac - 480Vac ± 10% (4kw@200~340Vac input, 6kw@341~480Vac input) w/o Neutral	3Φ 200Vac - 480Vac ± 10% (8kw@200~340Vac input, 12kw@341~480Vac input) w/o Neutral	3Φ 200Vac - 480Vac ± 10% (12kw@200~340Vac input, 18kw@341~480Vac input) w/o Neutral
Power Regeneration Efficiency ⁹	>89%(Typical)		
EMC & Safety	CE		
Fan Noise(dB)-Standby	62dB		
Fan Noise(dB) ¹⁰ -Full Load	<80dB		
Airflow max	57CFM	115CFM	170CFM
Input Cap.	4.08mF	8.16mF	12.24mF

Model	63706-600-40	63712-600-80	63718-600-120
Voltage ^{*2}	0-600V	0-600V	0-600V
Current ^{*3}	0-40A	0-80A	0-120A
Power ^{*4}	0-6,000W	0-12,000W	0-18,000W
Static mode			
Min. operating voltage (DC) ^{*5}	30V@40A	30V@80A	30V@120A
CC			
Range	0-40A	0-80A	0-120A
Resolution	10mA		
Accuracy	0.2%F.S.		
Ripple (rms)	<30mA	<60mA	<90mA
CR			
Range	0.1mΩ-7.5kΩ	0.1mΩ-3.75kΩ	0.1mΩ-2.5kΩ
Resolution	10mA / Vsense		
Accuracy	Vin/Rset*(0.4%)+0.4% IF.S.		
CV			
Range	0-600V		
Resolution	10mV		
Accuracy	0.1%F.S.		
Ripple (P-P) ^{*6}	420mV		
Ripple (rms) ^{*6}	85mV		
CP			
Range	0-6,000W	0-12,000W	0-18,000W
Resolution	0.4W	0.4W	0.4W
Accuracy ^{*7}	0.3%F.S.		
Dynamic mode			
T1 & T2	10ms-100s		
Resolution	1ms		
Accuracy	1ms+100ppm		
Slew rate ^{*8}	10mA/ms-20A/ms	10mA/ms-40A/ms	10mA/ms-60A/ms
Resolution	1mA/ms		
Accuracy	1% ± 2ms		
Min. rise time ^{*8}	2ms (Typical)		
Measurement			
Voltage read back			
Range	0-600V		
Resolution	10mV		
Accuracy	0.05%+0.05%F.S.		
Current read back			
Range	0-40A	0-80A	0-120A
Resolution	10mA		
Accuracy	0.1%+0.1%F.S.		
Power read back			
Range	0-6,000W	0-12,000W	0-18,000W
Resolution	100mW		
Accuracy ^{*7}	0.2%+0.2%F.S.		
Monitor			
Voltage Monitor			
Bandwidth	20kHz		
Range	0-600V		

Model	63706-600-40	63712-600-80	63718-600-120
Output	0-10V		
Accuracy	0.5%F.S.		
Output impedance	10kΩ		
Resolution	4mV		
Current Monitor			
Bandwidth	20kHz		
Range	0-40A	0-80A	0-120A
Output	0-10V		
Accuracy	0.75%F.S.		
Output impedance	10kΩ		
Resolution	4mV		
Signal			
Signal Output			
LOAD ON status	Active "High" when the load is on, TTL		
ALARM status	Active "High" when an alarm is in progress, TTL		
SHORT status	Active "High" when the short is on, TTL		
RANGE status	N/A		
Digital output	Defined by users		
Signal Input			
External load on	To control load on/off externally		
Trigger sequence	To trigger the following sequence, TTL		
Digital input	Defined by users		
Protection			
DC Side			
Over Current	Yes (Settable)		
Over Power	Yes (Settable)		
Over Temperature	Yes		
Over Voltage Alarm	Yes		
Reverse Alarm	Yes		
Under Voltage	N/A		
AC Side			
Voltage Range Error	Out of the voltage range		
Frequency Range Error	Out of the 47Hz - 63Hz range		
Open Phase	When one of the three phases is missing		
Interface			
Front USB (Host)	Standard (Type A)		
Rear USB (Device)	Standard (Type B)		
GPIB	GPIB send command to DC Load receiver <20ms Under GPIB command using Measure <25ms		
Ethernet (LXI)	Standard		
RS232	Optional		
CAN	Optional Cycling time < 10ms		
System Bus	Master/Slave		
Control Setting Time (CC Mode)	<20ms from command sent till the load starts to change		

Model	63706-600-40	63712-600-80	63718-600-120
Measurement Response Time (For both V&I)	<10ms		
General			
HxWxD	133 x 428 x 730 mm / 5.23 x 16.85 x 28.74 inch		
Weight	27kg / 59.5lbs	33kg / 72.75lbs	39.5kg / 87.1lbs
Operating Temp	0-40°C		
Storage Temp	-25-70°C		
Line Voltage	3Φ 200Vac - 480Vac ± 10% (4kw@200~340Vac input, 6kw@341~480Vac input) w/o Neutral	3Φ 200Vac - 480Vac ± 10% (8kw@200~340Vac input, 12kw@341~480Vac input) w/o Neutral	3Φ 200Vac - 480Vac ± 10% (12kw@200~340Vac input, 18kw@341~480Vac input) w/o Neutral
Power Regeneration Efficiency ^{*9}	>92%(Typical)		
EMC & Safety	CE		
Fan Noise(dB)-Standby	62dB		
Fan Noise(dB) ^{*10} -Full Load	<80dB		
Airflow max	57CMF	115CMF	170CMF
Input Cap.	260μF	520μF	780μF

Model	63712-1200-40	63718-1200-40	63718-1800-40
Voltage ^{*2}	0-1,200V	0-1,200V	0-1,800V
Current ^{*3}	0-40A	0-40A	0-40A
Power ^{*4}	0-12,000W	0-18,000W	0-18,000W
Static mode			
Min. operating voltage (DC) ^{*5}	60V@40A	90V@40A	
CC			
Range	0-40A		
Resolution	10mA		
Accuracy	0.2%F.S.		
Ripple (rms)	<30mA		
CR			
Range	0.1mΩ-15kΩ	0.1mΩ-22.5kΩ	
Resolution	10mA / Vsense		
Accuracy	Vin/Rset*(0.4%)+0.4% IF.S.		
CV			
Range	0-1,200V	0-1,200V	0-1,800V
Resolution	100mV		
Accuracy	0.1%F.S.		
Ripple (P-P) ^{*6}	840mV	1,260mV	
Ripple (rms) ^{*6}	170mV	255mV	
CP			
Range	0-12,000W	0-18,000W	
Resolution	1W		

Model	63712-1200-40	63718-1200-40	63718-1800-40
Accuracy ^{*7}	0.3%F.S.		
Dynamic mode			
T1 & T2	10ms-100s		
Resolution	1ms		
Accuracy	1ms+100ppm		
Slew rate ^{*8}	10mA/ms-20A/ms	10mA/ms-20A/ms	
Resolution	1mA/ms		
Accuracy	1% ± 2ms		
Min. rise time ^{*8}	2ms (Typical)		
Measurement			
Voltage read back			
Range	0-1200V	0-1200V	0-1800V
Resolution	100mV		
Accuracy	0.05%+0.05%F.S.		
Current read back			
Range	0-40A		
Resolution	10mA		
Accuracy	0.1%+0.1%F.S.		
Power read back			
Range	0-12,000W	0-18,000W	
Resolution	100mW		
Accuracy ^{*7}	0.2%+0.2%F.S.		
Monitor			
Voltage Monitor			
Bandwidth	20kHz		
Range	0-1200V	0-1200V	0-1800V
Output	0-10V		
Accuracy	0.5%F.S.		
Output impedance	10kΩ		
Resolution	4mV		
Current Monitor			
Bandwidth	20kHz		
Range	0-40A		
Output	0-10V		
Accuracy	0.75%F.S.		
Output impedance	10kΩ		
Resolution	4mV		
Signal			
Signal Output			
LOAD ON status	Active "High" when the load is on, TTL		
ALARM status	Active "High" when an alarm is in progress, TTL		
SHORT status	Active "High" when the short is on, TTL		
RANGE status	N/A		
Digital output	Defined by users		
Signal Input			
External load on	To control load on/off externally		
Trigger sequence	To trigger the following sequence, TTL		
Digital input	Defined by users		
Protection			
DC Side			

Model	63712-1200-40	63718-1200-40	63718-1800-40
Over Current	Yes (settable)		
Over Power	Yes (settable)		
Over Temperature	Yes		
Over Voltage Alarm	Yes		
Reverse Alarm	Yes		
Under Voltage	N/A		
AC Side			
Voltage Range Error	Out of the voltage range		
Frequency Range Error	Out of the 47Hz - 63Hz range		
Open Phase	When one of the three phases is missing		
Interface			
Front USB (Host)	Standard (Type A)		
Rear USB (Device)	Standard (Type B)		
GPIB	GPIB send command to DC Load receiver <20ms Under GPIB command using Measure <25ms		
Ethernet (LXI)	Standard		
RS232	Optional		
CAN	Optional Cycling time < 10ms		
System Bus	Master/Slave		
Control Setting Time (CC Mode)	<20ms from command sent till the load starts to change		
Measurement Response Time (for both V&I)	<10ms		
General			
HxWxD	133 x 428 x 730 mm / 5.23 x 16.85 x 28.74 inch		
Weight	33kg / 72.75lbs	39.5kg / 87.1lbs	
Operating Temp	0-40°C		
Storage Temp	-25-70°C		
Line Voltage	3Φ 200Vac - 480Vac ± 10% (8kw@200~340Vac input, 12kw@341~480Vac input) w/o Neutral	3Φ 200Vac - 480Vac ± 10% (12kw@200~340Vac input, 18kw@341~480Vac input) w/o Neutral	
Power Regeneration Efficiency ^{*9}	>92%(Typical)		
EMC & Safety	CE		
Fan Noise(dB)-Standby	62dB		
Fan Noise(dB) ^{*10} -Full Load	<80dB		
Airflow max	115CMF	170CMF	
Input Cap.	130μF	86.67μF	

All specifications are subject to change without prior notice.

- Note**
1. The specifications are guaranteed within the temperature range of $25\pm 5^{\circ}\text{C}$.
 2. The equipment could be damaged if the operating voltage exceeds 1.05 times the rated voltage.
 3. The current does not sink when it is less than 0.5% of the rated current.
 4. The rated power specifications are with an ambient temperature of $0\sim 40^{\circ}\text{C}$.
 5. The loading waveform is not guaranteed when the external voltage is lower than the minimum working voltage.
 6. From 20 Hz to 20 MHz for peak-to-peak noise; from 20 Hz to 300 kHz for rms noise. (A 44nF and 104.7 μF capacitor are connected to the loading terminal for measurement.) (Reference TN board Capacitor)
 7. Power F.S. = Vrange F.S. \times Irange F.S.
 8. The Slew rate is defined at 10%~90%.
 9. The efficiency point at 480Vac input voltage and full load output (V_o Max).480Vac
 10. This test value is the maximum noise value measured 1 meter in front of the device frame after 5 minutes of full power operation at an ambient temperature of 40°C .
 11. When the measured power range is larger than 18kW, the resolution is 200mW and the accuracy is 0.5%F.S.
 12. When the inlet air temperature of the front panel is 35°C (incl.) or below, the operating power can be increased to 1.2 times the rated power except for CP mode.

- CAUTION**
1. For applications with switching power supply and cable lengths greater than 20cm, it is recommended the cables be twisted and parallel capacitance be added to prevent oscillations, see Figure 1-1.
 2. Do not wrap the external input, output, and communication cables together to avoid cross-interference errors.
 3. Be sure to place the electronic load horizontally (top side up) when using or for storage Do not stand the electronic load vertically for a long period to avoid internal damage to the device.
 4. It is not recommended to hook up a relay when there is a voltage difference to avoid damaging the Electronic Load due to instantaneous overcurrent.

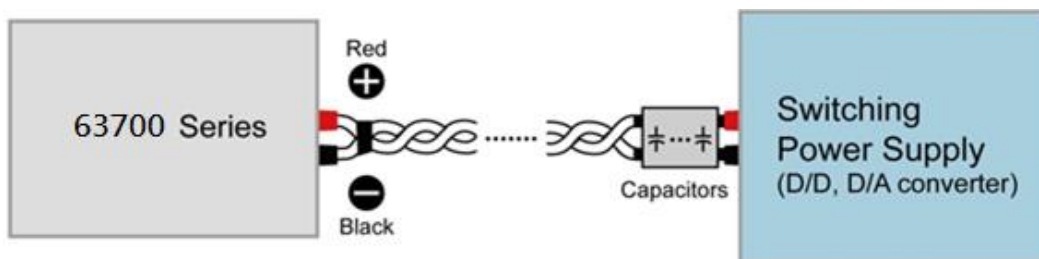

Figure 1-1

- WARNING** Voltage from the two output terminals to earth varies with the 63700 Series models as Table 1-2 shows:

Table 1-2

Model	Max. Voltage (Vdc) Difference between Output Terminal and Earth
63706-100-180	1000
63712-100-360	
63718-100-540	
63706-600-40	3000
63712-600-80	

63718-600-120	
63712-1200-40	
63718-1200-40	
63718-1800-40	

If the voltage exceeds the above range it may result in damage to the DC electronic load.

1.4 Function Buttons

1.4.1 Front Panel

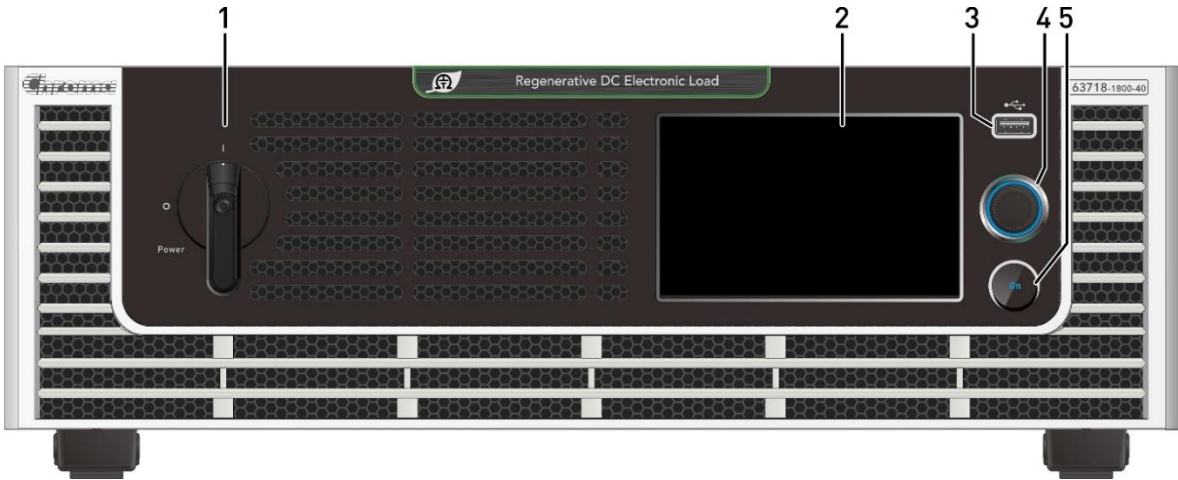

Figure 1-2 Front Panel of 63700 Series Models

Table 1-3 Front Panel Description

Item	Symbol	Description
1		Main Power Switch: Turn on or off the power.
2		LCD Touch Panel: Use the icons as they appear on the touch screen to set the voltage, current, and other measurements.
3		USB HOST: Download data and upgrade firmware, etc.
4		Rotary Knob: The rotary knob is used to edit the settings on the screen. When the settings are complete, press the rotary knob to confirm the input value.
5		Load ON Button: Press the ON button, the light on means Load ON, and the light off means Load OFF.

1.4.2 Rear Panel

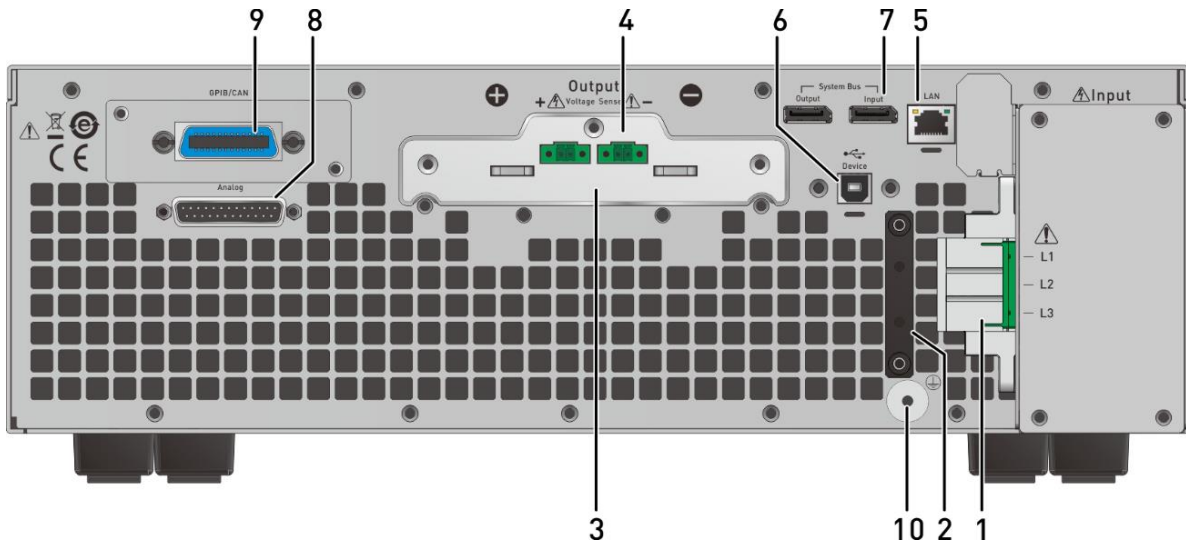

Figure 1-3 Rear Panel of 63700 Series Models

Table 1-4 Rear Panel Description

Item	Name	Description
1	AC power connector	AC power input connector.
2	AC power cord anti-pulling device	Connects to the AC power cord connector to prevent the cord from loosening due to external force during operation.
3	Output terminal	The output terminals of DC electronic load.
4	Voltage sense connector	Connecting this connector to the load can compensate for the voltage drop generated due to cable resistance. Be sure to connect the remote sense connector "+" to the positive output terminal and the "-" connector to the negative output terminal. Do not reversely connect the remote sense connector and the "+" and "-" polarity on the output terminal.
5	Ethernet connector	The remote controller uses an ETHERNET bus to connect to the PC for remote operation.
6	USB port	The remote controller uses a USB bus to connect to the PC for remote operation.
7	System bus	It is for serial/parallel data transmission. (Remove this cable if the electronic load is not connected in series or parallel.)
8	ANALOG interface signal connecting terminal	There are 25 pins signals including APG input/output terminals and system status signal terminals. See <i>Appendix A</i> for detailed pin assignments.
9	GPIB/CAN (option) connector	Used for GPIB/CAN control via an external PC for remote operation.
10	Functional Ground	This terminal is to connect the electronic load to earth grounding.

Notice

Item 9 in Figure 1-3 is an optional GPIB/CAN interface of the 63700 series selected by the user. A blank panel will be installed if no interface is selected.

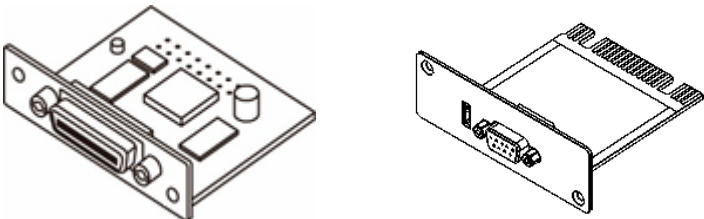

Figure 1-4 GPIB/CAN Interface

1.5 Dimension

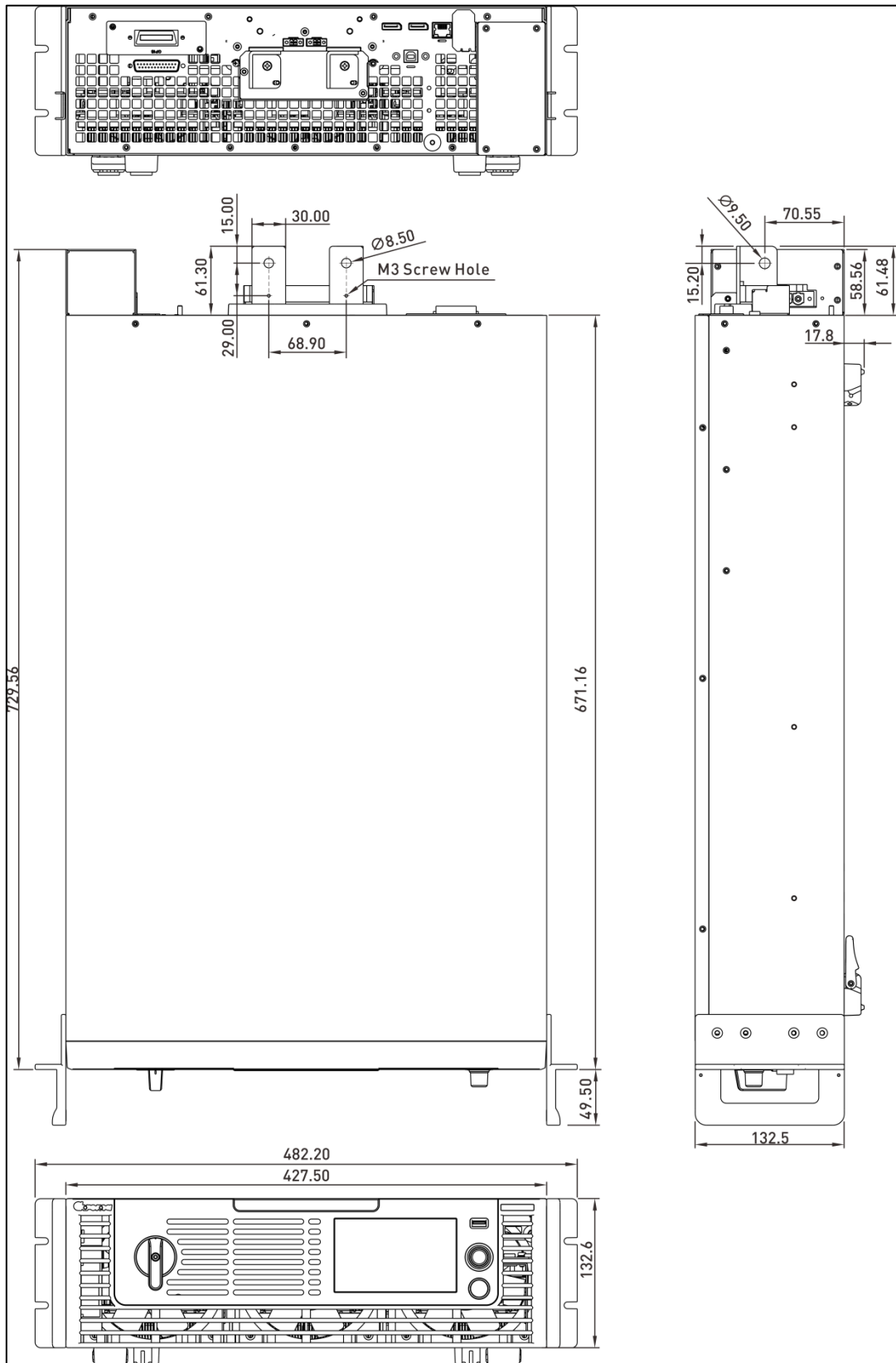

Figure 1-5 Dimension of 100V Models

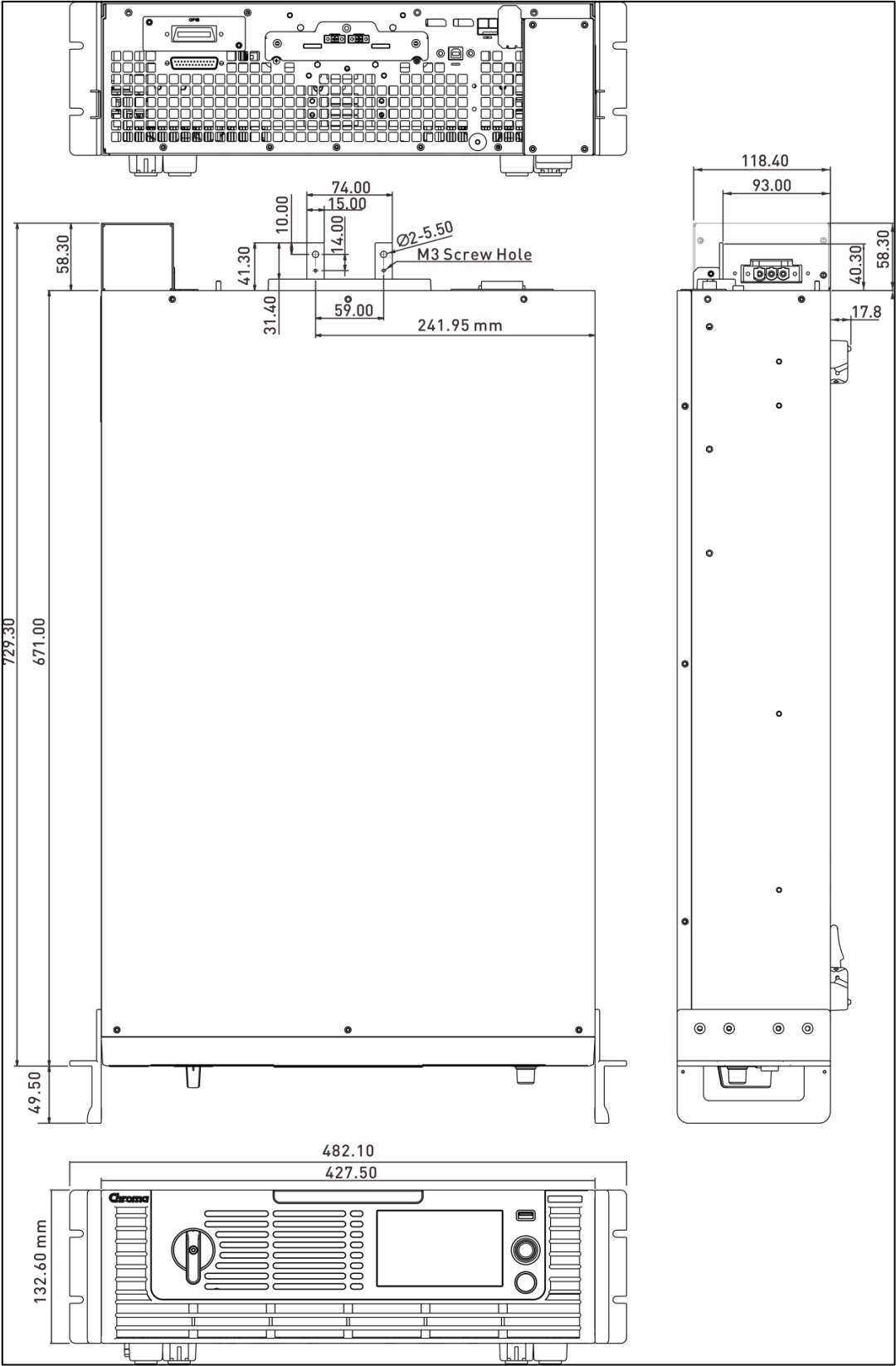

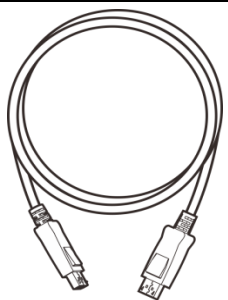





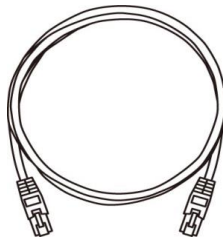
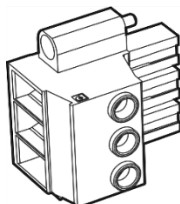
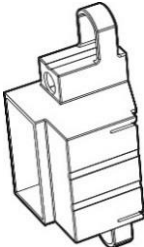
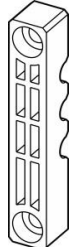

Figure 1-6 Dimension of 600V/1,200V/1,800V Models







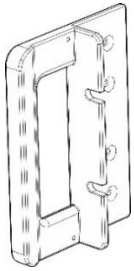

2. Installation

2.1 Checking the Package

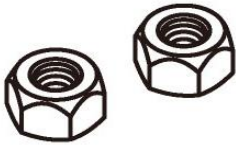
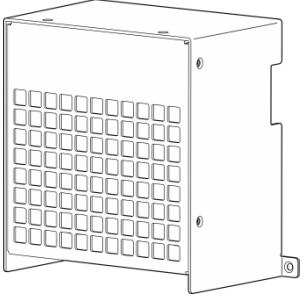

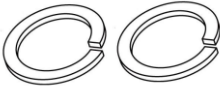



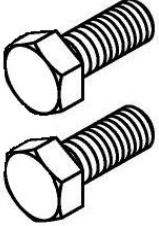



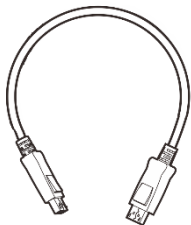

1. Check for any damage or missing accessories after unpacking.
2. Should any damage be found, contact the shipping company and Chroma's service department immediately of the agent that the device was purchased. It is also recommended to take pictures of both the instrument's damage and the shipping container and that the shipping container is kept for future reference.

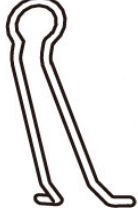

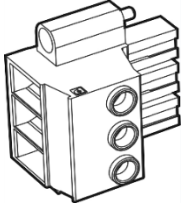
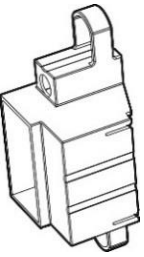

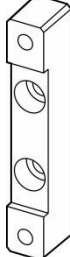
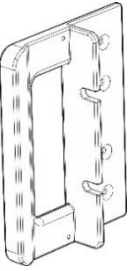

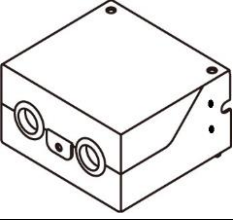

The standard accessories of 63700-100V models are listed as follows:

Standard Accessories				
Item				
Name	Current Sharing Cable (Display port 30cm)	USB Cable	Stylus	Stylus Spring Wire
P/N	W38-000844*1	W38-000082*1	A55-000289*1	G55-001131*1
Item				
Name	USB Cable Hoop	Ethernet Cable Hoop	Ethernet Cable	AC Input Connector
P/N	G32-005010*1	G32-005011*1	W31-000053*1	W52-000098*1
Item				
Name	AC Input Connector Cover	Input Cable Cleat	Input Cable Cleat	
P/N	G29-000106*1	G32-014501*1	G32-014502*1	

Standard Accessories				
Item				
Name	Rack Handle	M4x10 Screw (Handle)	8 Φ Washer	M8 Nut
P/N	G28-000146*2	H61-401020*8	H81-800000*4	H71-805800*2
Item				
Name	Output Cover Set	M3x6L Flat Head Screw	SP/ Washer, 8 Φ	M4x8 Screw
P/N	G29-000124 *1 pcs G29-000123 *1 pcs G53-000809 *1 pcs W61-006000 *2 pcs H61-300621 *6 pcs	H61-300621*3	H82-800000*2	H61-400850*2
Item				
Name	M3x6 Screw	M4x10 Screw	M4x16 Screw	M8x20 Screw
P/N	H69-300641*2	H61-401052*2	H69-401550*2	H61-802030*2

The standard accessories of 63700-600V/1200V/1800V models are listed as follows:

Standard Accessories				
Item				
Name	Current Sharing Cable (Display port-30cm)	USB Cable	Stylus Current Sharing Cable (Display port)	Stylus Spring Wire
P/N	W38-000844*1	W38-000082*1	A55-000289*1	G55-001131*1
Item				
Name	USB Cable Hoop	Ethernet Cable Hoop	Ethernet Cable	AC Input Connector
P/N	G32-005010*1	G32-005011*1	W31-000053*1	W52-000098*1
Item				
Name	AC Input Connector Cover	Input Cable Cleat	Input Cable Cleat	
P/N	G29-000106*1	G32-014501*1	G32-014502*1	
Item				
Name	Rack Handle	M4x10 Screw (Handle)	M5x13 Washer	M5-8 Nut
P/N	G28-000146*2	H61-401020*8	H81-501301*2	H71-000029*2

Standard Accessories				
Item				
Name	Output Cover Set	M3x6L Flat Head Screw	M4x8 Flat Head Screw	M4x8 Screw
P/N	G29-000112 *1 pcs G29-000114 *1 pcs G53-000771 *1 pcs G53-000770 *1 pcs W61-000010 *2 pcs H61-300621 *2 pcs H69-300641 *1 pcs	H61-300621*2	H61-400820*2	H61-400850*2
Item				
Name	M3x6 Screw	M4x10 Screw	M4x16 Screw	M5x15 Screw
P/N	H69-300641*2	H61-401052*2	H69-401550*2	H61-501550*2

Notice

1. Please keep all of the packing materials in case the device has to be returned for repair.
2. Do not return the instrument to the factory without obtaining prior RMA acceptance from Chroma.
3. Check if all accessories that are listed in the packing list are received.

CAUTION

The electronic load is too heavy for one person to safely lift and assemble. To avoid injury, ask for assistance during installation.

2.1.1 Maintenance and Cleaning

Remove all connected wires and cables on the instrument before cleaning. Use a brush to clean the dust. If there are stains on the chassis that cannot be removed by brush, wipe with a volatile liquid (such as Cleaning Naphtha). Do not use any corrosive liquid to avoid damaging the chassis. Use a damp cloth with soap water or soft detergent to clean the VFD front panel. For internal cleaning, use a low-pressure air gun to dust inside or send it back to our agent for cleaning.

2.2 Preparation for Use

1. Be sure the electronic load is connected to the AC line input that meets the specification.
2. The instrument must be installed in a well-ventilated area to avoid the internal temperature getting too high.
3. Ensure ambient air does not exceed 40°C.

2.2.1 Common Environment Conditions

1. Indoor use.
2. Altitude up to 2,000 meters.
3. Operating ambient temperature 0°C to 40°C.
4. Operating ambient humidity 0%rh to 90%rh (no condensation).
5. Storage ambient temperature -25°C to 70°C.
6. Storage ambient humidity 0%rh to 90%rh (no condensation).
7. Input AC supply voltage fluctuations can be up to $\pm 10\%$ of the rated voltage.
8. Transient over voltage is impulse withstand CAT II.
9. Pollution degree II.

2.3 Requirements of Input Power

2.3.1 Ratings

- (1) 100V models

Input voltage/frequency range: V_{LL} : 380-480V $\pm 10\%$ 3~ 4W / 47-63Hz
 V_{LL} : 200-220V $\pm 10\%$ 3~ 4W / 47-63Hz

Maximum input power:

Model	63706-100-180	63712-100-360	63718-100-540
V_{in}			
200Vac	3.6kVA	7.2kVA	10.8kVA
380/ 480Vac	5.4kVA	10.8kVA	16.2kVA

Maximum input current:

Model	63706-100-180	63712-100-360	63718-100-540
V_{in}			
200Vac	13A	26A	39A
380Vac	9A	17A	25A
480Vac	7A	13A	20A

- (2) 600V/1,200V/1,800V models

Input voltage/frequency range: V_{LL} : 380-480V $\pm 10\%$ 3~ 4W / 47-63Hz
 V_{LL} : 200-220V $\pm 10\%$ 3~ 4W / 47-63Hz

Maximum input power:

Model	63706-600-40	63712-600-80 63712-1200-40	63718-600-120 63718-1200-40 63718-1800-40
Vin			
200Vac	3.8kVA	7.6kVA	11.4kVA
380/ 480Vac	5.7kVA	11.4kVA	17.1kVA

Maximum input current:

Model	63706-600-40	63712-600-80 63712-1200-40	63718-600-120 63718-1200-40 63718-1800-40
Vin			
200Vac	14A	27A	41A
380Vac	9A	18A	26A
480Vac	7A	14A	21A

- (3) The leakage current of the 63700 Series DC Electronic Load is about 3mA.
- (4) Since the 63700 Electronic Load is supplied with a full range of input power and different input power ranges correspond to different output power settings, it will take 40 seconds for the device to turn off and on again to completely shut down the system; otherwise, an AD_UVP or AD_OVP may be judged mistakenly and issue a warning message.

2.3.2 Input Connection

- (1) The input power connector is located at the right of the rear panel.
- (2) The power line must be rated at least 105°C.
- (3) The power cable width must be 8AWG at least.
- (4) Assembly ➡ see Figure 2-1(a)~(d) and execute the following steps:
 - a. Secure the power cable and input terminal with a screwdriver (AC input connector and AC input connector cover).
 - b. Insert the AC power connector into the AC terminal and secure the protection cover (via M3x6 flat head screw).
 - c. Secure the grounding terminal to the grounding copper stud on the chassis (via an M4x0.7 flange nut).
 - d. Secure the input cable cleat with M4x10 and M4x16 round head screws to prevent the AC power connecting terminal from falling off.

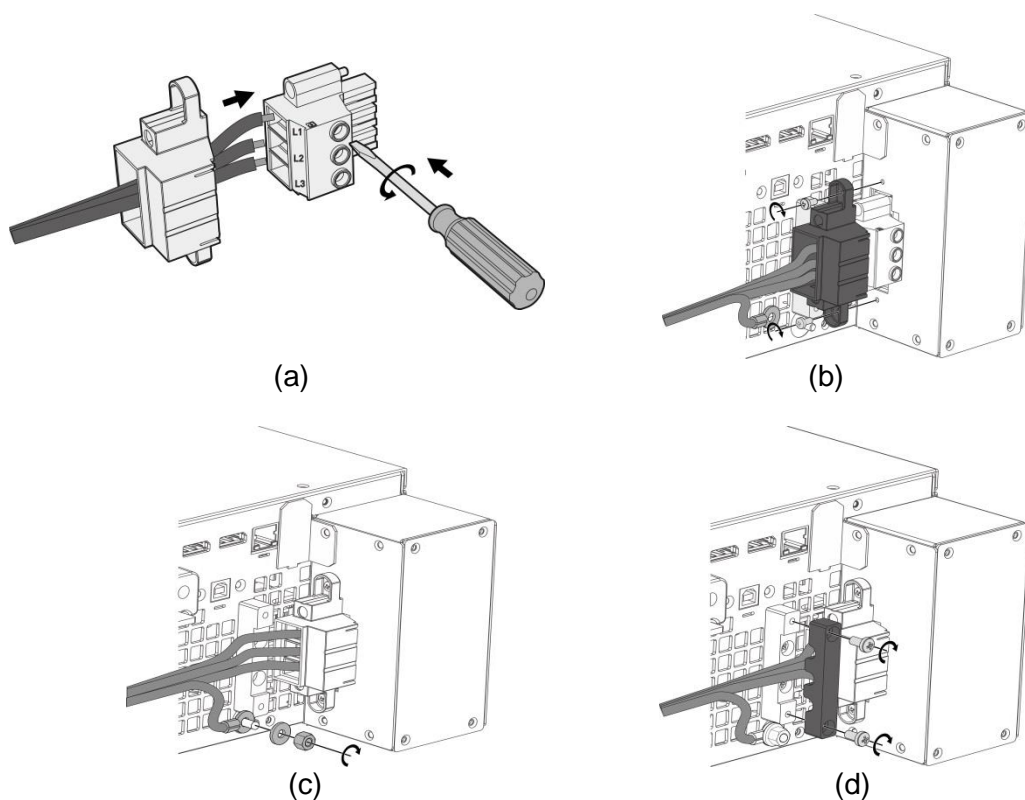



Figure 2-1

Notice

1. Connect the green or green/yellow grounding wire to the  terminal.
2. Connect the red black or blue power wire to the “L1, L2, L3” terminal.

WARNING

1. To protect the operators, the wire connected to the GND terminal () must be connected to the earth. Under no circumstances shall this DC electronic load be operated without an adequate ground connection.
2. Installation of the power cord must be done by a professional and compliant with local electrical codes.

CAUTION

1. Be sure to select an appropriate withstand voltage cable based on the varied input voltage.
2. To ensure operation safety, follow the input power source during installation to select the rated current breaker that closes to each phase and connect it to the input terminal in series.
3. The breaker should be installed inside the building. See Table 2-3 for the rating.

Table 2-1 lists the conductor sectional area for safe use of the input current and anti-pulling wire diameter.

Table 2-1 Suggested Cable Specification

Conductor Area Sectional Area mm ²	Safe Current (A)		Diameter for Anti- pulling Standard (mm)
	Copper Conductor		
8.0	55		6.65 ± 0.15

Table 2-2 lists the PVC (105°C) wire specification references when the ambient temperature is 30°C.

Table 2-2 PVC (105°C) Cable Specification

Conductor Area Sectional Area mm ²	Safe Current (A)	
	Copper Conductor	Aluminum conductor
1.25	15	--
2.0	20	--
3.5	30	--
5.5	40	--
8.0	55	--
14	70	50
22	90	70
30	120	90
38	145	100
50	175	120
80	230	150
100	260	200
125	300	240
150	350	270
200	425	330
250	500	380
325	600	450
400	700	500
500	800	600

Table 2-3 Breaker Rating

Model	Breaker Rating(A)
63706-xxx-xxx	20A max.
63712-xxx-xxx	30A max.
63718-xxx-xxx	50A max.

2.4 Remote Sensing

2.4.1 Correct Connection

1. Connecting remote sensing wires correctly can ensure the measurement of the UUT voltage.
2. Figure 2-2 shows the correct connection. Use two wires to connect the positive/negative connector of the load to the remote sensing connector on the rear panel. The connecting wire diameter must be 22AWG, and its withstand voltage should meet the 3kV specification.

3. Though remote sensing can compensate for the voltage drop, if the line loss is too large (see specification) it will cause protection error on remote sensing.
4. Remote sensing wire must be connected to the copper bar output terminal OR the load UUT output terminal

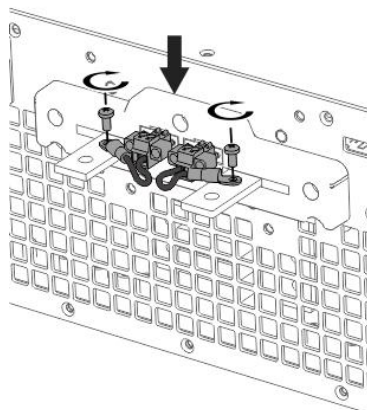

Figure 2-2

2.4.2 Reverse Connection of Remote Sensing Wire Polarity

The polarity of the remote sensing wire must be connected correctly, the “+” terminal is connected to the “+” side of the output terminal and the “-” terminal must be connected to the “-” side of the output terminal. If the polarity is connected reversely, an error message “SENSE_FAULT” will prompt as Figure 2-3 shows.

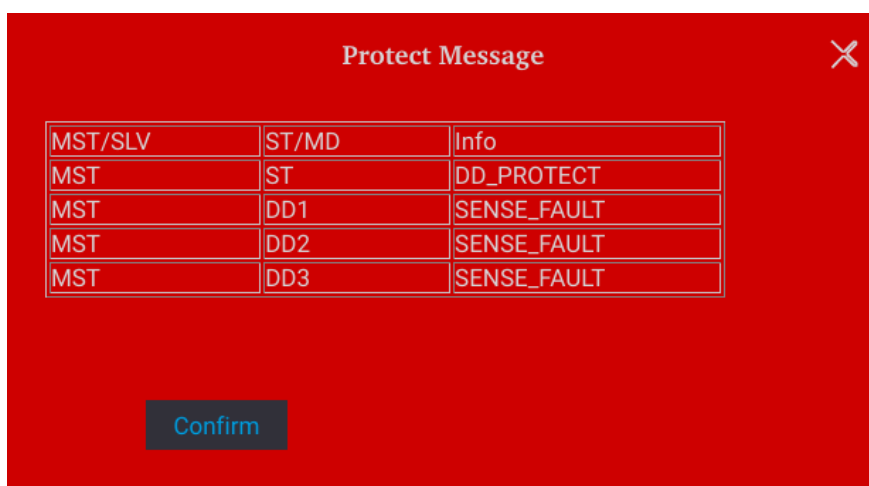

Figure 2-3

Notice

In the event of a reverse polarity error condition, proceed as follows to reset it:

1. First power it off.
2. Connect the remote sensing wire properly.
3. Restart the DC electronic load.

- ⚡ CAUTION**
1. If there is a voltage on the electronic load output, do not reverse connect the Remote sense to it or to the UUT to avoid damaging the electronic load.
 2. The voltage of the Remote Sense and local output needs to be smaller than 4% V_{MAX} to avoid damaging the electronic load.

2.5 Output Connection

The output connector of the 63700 Series DC electronic load is located in the upper middle area on the rear panel. The DC power is connected to the “+” and “-” output terminals.

2.5.1 Rear Panel Output

- (1) The output terminal is located in the upper middle area on the rear panel.
- (2) The output cable must be rated to at least 85°C with a conductor sectional area of more than 38mm².
- (3) Assembly ➡ follow Figure 2-5 (a)~(d) to execute the steps below:
 - a. Strip insulation off the ends of the power cable tip (the bare portion is about 1cm) and use an O-type terminal to crimp it.
 - b. Secure the power cable and input terminal with a Phillips screwdriver.
 - c. Secure the safety cover latch and safety cover to prevent the cable from falling or the electric terminal from exposure.

Table 2-4 Safety Cover

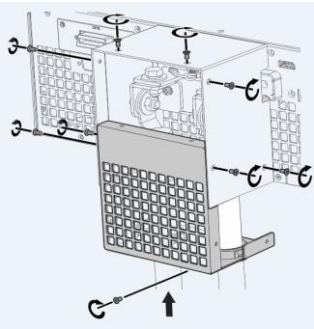
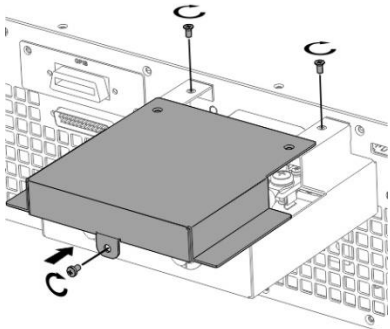
Safety Cover	Applicable Range	Applicable Model
	$V_o=0\sim 100V$ $I_o=1\sim 540A$	100V models
	$V_o=0\sim 1800V$ $I_o=0\sim 40A$	600V/1,200V/1,800V models

For the models requiring a larger safety cover, a cable with a wider diameter is needed. To ensure the output terminal is not stressed assemble it as the figure shown below.

Assembly of 100V models:

- a. Remove the output protective cover and pass the power output cable through the output protective cover A.
- b. Secure the power output wire (external hex screw M8x20, flat washer 8Φ, spring washer 8Φ, hex nut M8) to the output end of the electronic load.
- c. Secure the output protective cover B (flat head screw M4x8) to the chassis.
- d. Lock the output protective cover A and B (countersunk screw M3x6).
- e. Secure the output protective cover A to the chassis (flat head screw M3x6).

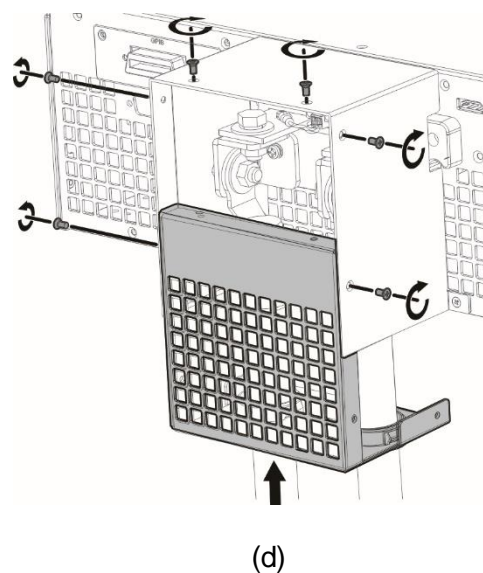
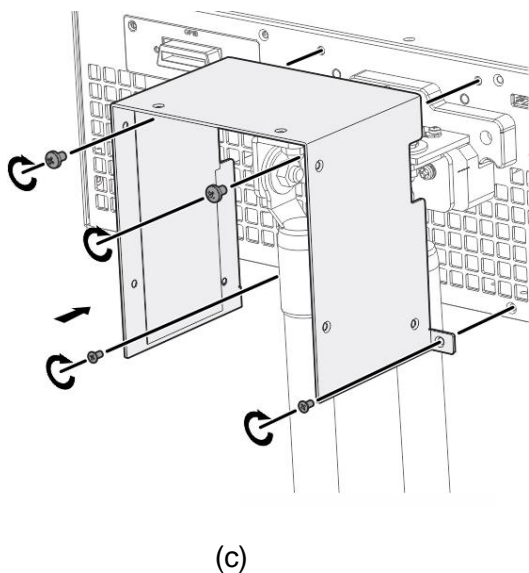
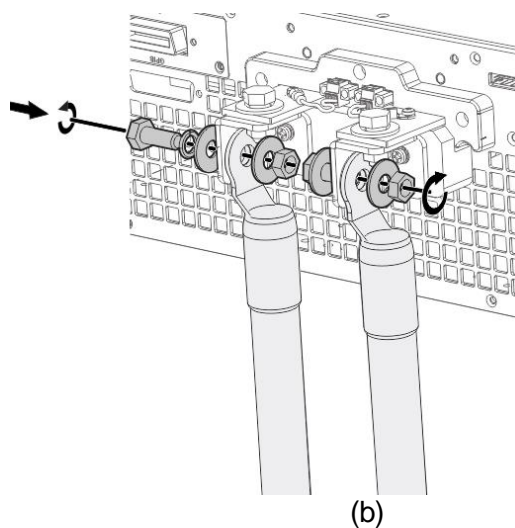
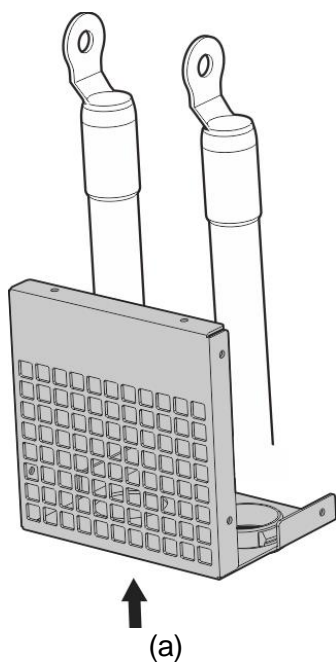

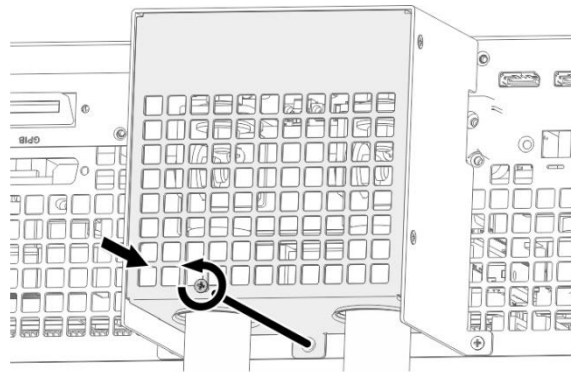

(e)

Figure 2-4 Assembly of 100V Models

Assembly of 600V/1,200V/18,00V models:

- a. Remove the output protective cover and pass the power output cable through the output protective cover A. ◦
- b. Secure the power output wire (round head screw M5x15, flat washer M5x13, hex nut M5) to the output end of the electronic load.
- c. Secure the output protection cover A to the chassis (countersunk screws M4x8, flat head screw M4x8).
- d. Lock the output protective cover A and B (countersunk screw M3x6, flat head screw M3x6).

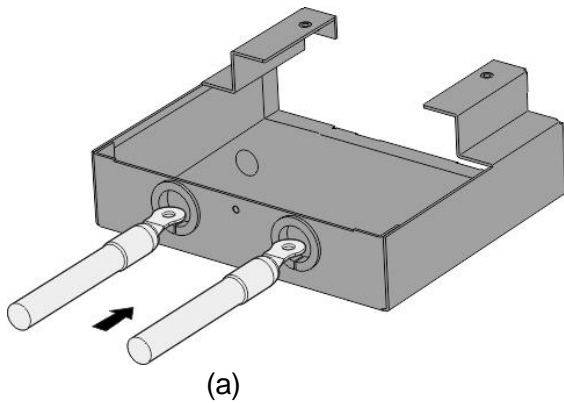

(a)

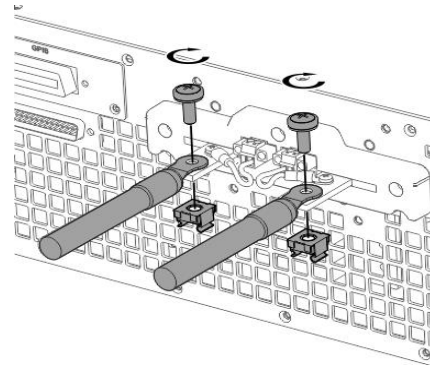

(b)

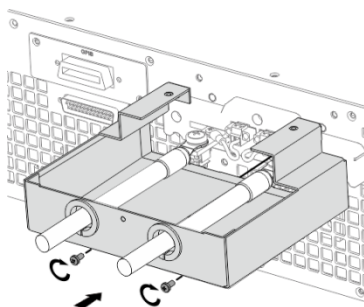

(c)

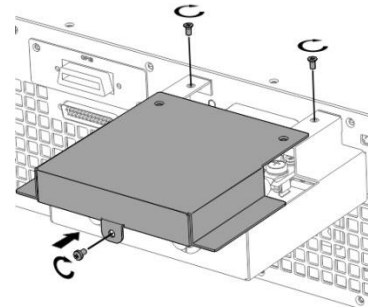

(d)

Figure 2-5 Assembly of 600V/1,200V/18,00V Models



CAUTION

1. To meet the safety requirement, the safety cover must be tightly secured.
2. The diameter of the wire connected to the load must be able to carry the maximum current applied.

3. Be sure to select the proper output wire that can withstand the voltage based on the model.

⚠ WARNING

For safety, do not exceed the rated current (varies with 63700 series models) for the output current.

2.5.2 Specification of Connecting Wire

The maximum inductance of connecting wire to the electronic load is the total inductance of two wires after being twisted or processed otherwise including self-inductance and mutual inductance. Do not exceed the specifications listed in the table below.

Table 2-5

Model	Maximum Output Inductance (μH)
100V models	200
600V/1,200V/1,800V models	400

⚡ CAUTION

1. To ensure the system's stability, the cable inductance should not exceed the above limits.
2. Do not use wire of an extra thin diameter to avoid overheating and causing a hazard.

2.5.3 Installing the Handle

Use M4x12 flat head screws to secure the handle to the rack mounting kit as shown in Figure 2-6.

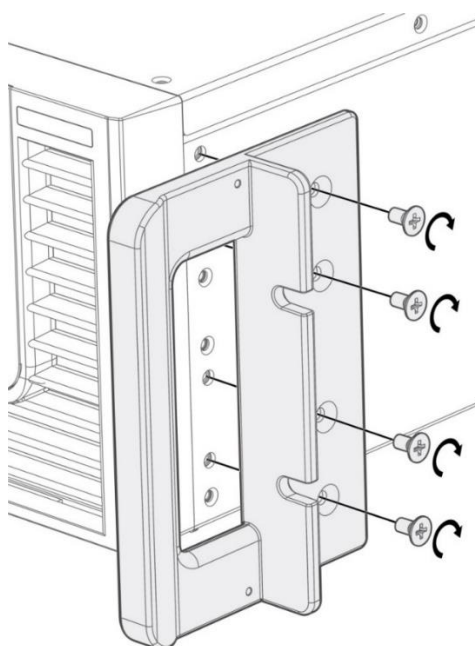

Figure 2-6

2.6 Power on Procedure

Plug in the power cord and turn on the power switch on the front panel. The DC electronic load will run a series of self-tests. The display on the front panel will turn on to run self-tests for CPLD (complex programmable logic device), memory, data, and communication as Figure 2-7 shows.

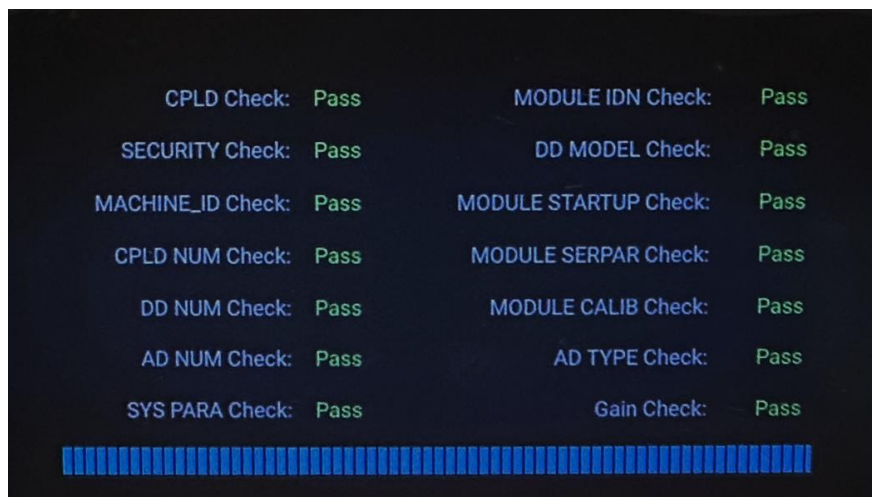

Figure 2-7

When the self-tests of memory, data, and communication are done, the screen automatically turns to the MAIN page as Figure 2-8 shows:



Figure 2-8

WARNING The DC electronic load internal circuit may not be able to reset if it is powered off and on immediately. It is suggested to wait for 3 seconds after powering it off and on again.

CAUTION Before turning on the instrument, all protective grounding terminals, extension cords, and devices must connect to the earth. The hazard of potential electric shock may occur if any interrupted grounding and could cause injury or death.

3. Manual Operation

3.1 Introduction

The DC electronic load can be operated manually or remotely via GPIB/CAN (option), LAN, USB, or APG interface which is described in Chapter 4 and section 3.2.3.1. Refer to the manual operation for using the front touch panel or rotary knob to input data described in this chapter.



The operation mode defaults to manual mode whenever power to the load is turned on.

3.2 Menu for Setup

The Menu provides you with various settings for configuring the system functions of the DC electronic load. The functions include:

1. Meas. & Setup: To set the basic parameters for CC, CV, CR, CP, and CCD modes.
2. System Setup: To set the display panel, various protections, time, and factory defaults.
3. Configuration: To set the communication interface, serial/parallel settings, and calibration.

The Menu screen is shown in Figure 3-1 with a complete function tree as shown in Figure 3-2.

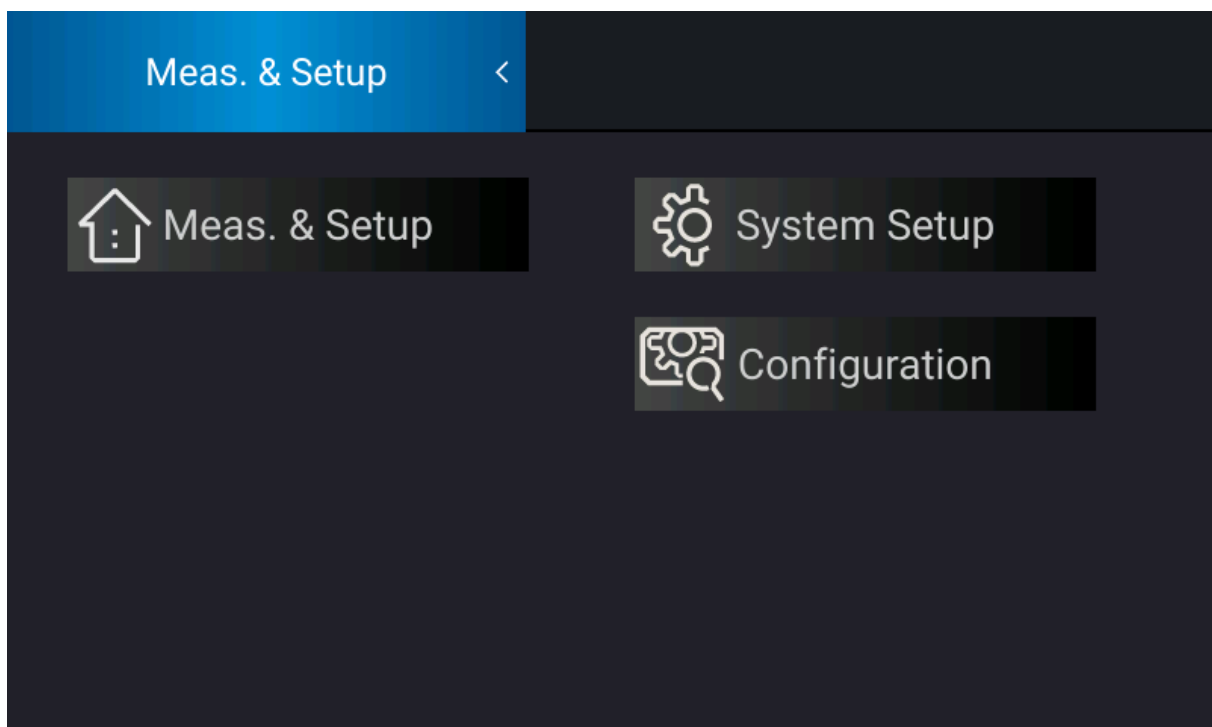

Figure 3-1

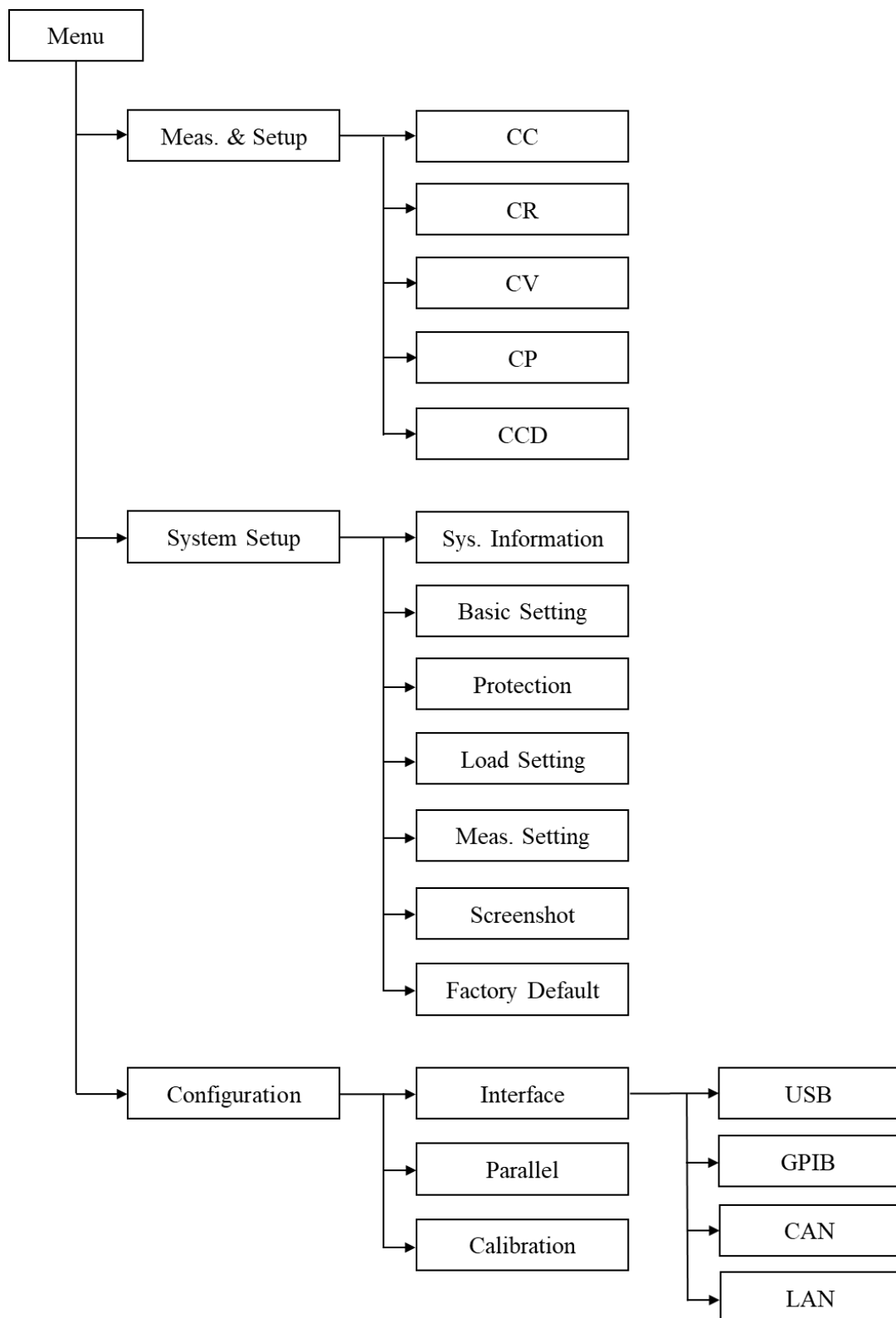

Figure 3-2

3.2.1 Meas. & Setup

There are five operation modes: Constant Current (CC), Constant Resistance (CR), Constant Voltage (CV), Constant Power (CP), and Constant Current Dynamic (CCD).

Tap the current mode pattern to select the mode from the mode menu, the load will change accordingly. When changing the mode, the load input will temporarily stop programming before the new mode is activated. When the current, resistance or voltage mode is selected, the programming parameters of this mode will be executed.

3.2.1.1 Constant Current (CC)

In constant current mode, no matter what the input voltage is, the load will sink according to the programmed current value. To enter the CC mode, tap the present mode and select CC mode from the mode menu.

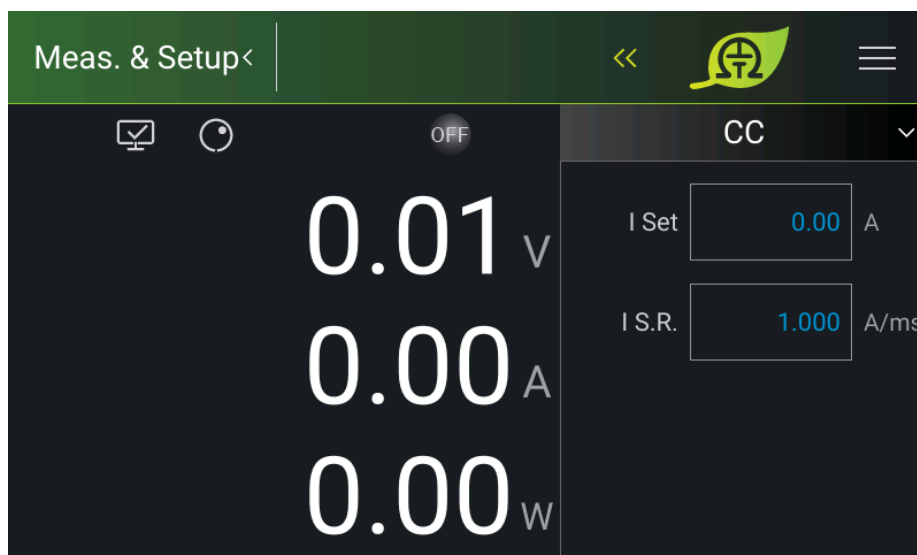

Figure 3-3

Parameters:

I Set: Sets the constant current loading parameters.

I S.R: Sets the current rise/fall slew rate.

There are two ways to set the value:

Method 1:

1. When the value of I Set is done, the touch panel will switch to a numeric keypad as Figure 3-4 shows.
2. Use the numeric buttons (0 ~ 9) to set the value and tap “\leftarrow” to complete the voltage setting.
3. Press “on” to start loading constant current.

Method 2:

1. Tap “on” on the panel to use the “Rotary” (⦿) knob and tap the I Set value, the cursor at the lower right of the number on the main screen will flicker.

2. When using the “Rotary” (⊙) knob for setting, pressing the knob can move the cursor to an individual digit, and then turn the rotary knob to increase or decrease the set value.
3. Press “” to start loading for constant current.

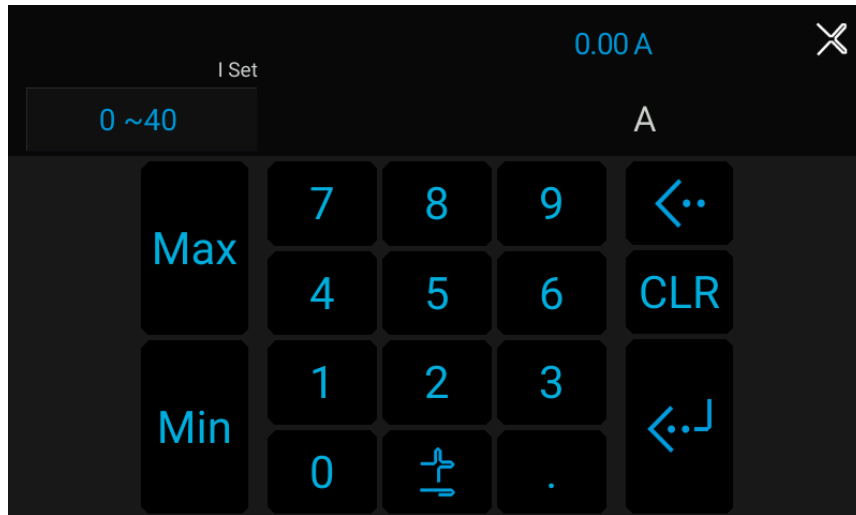

Figure 3-4

3.2.1.2 Constant Resistance (CR)

In constant resistance mode, the electronic load will follow the programmed resistance to sink current from the input voltage. To enter the CR mode, tap the present mode and select CR mode from the mode menu.

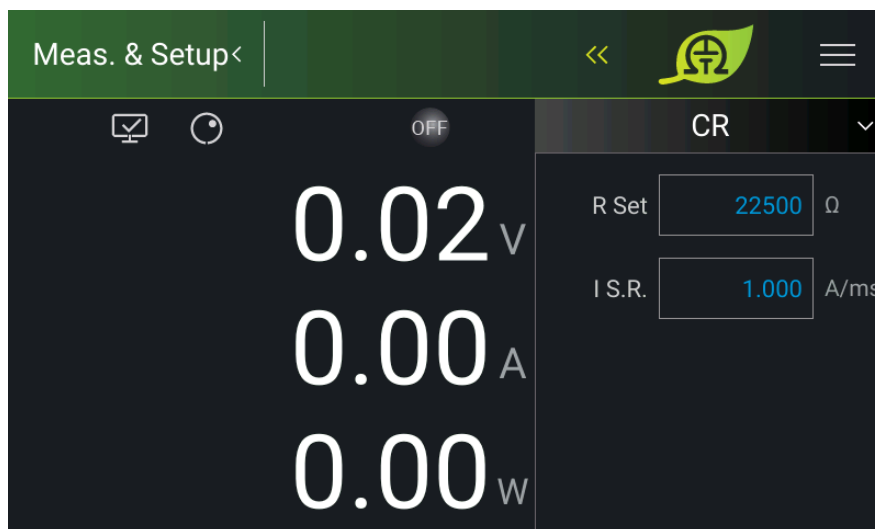

Figure 3-5

Parameters:

R SET: Sets the constant resistance loading parameters.

I S.R: Sets the current rise/fall slew rate.

The value set is the same as in CC mode.

3.2.1.3 Constant Voltage (CV)

In constant voltage mode, the electronic load follows the programmed voltage to control the output voltage of the current source by adjusting the sinking method. The constant voltage mode has two response speeds: FAST and SLOW. To enter into CV mode, tap the present mode and select CR mode from the mode menu.



Figure 3-6

Parameters:

V SET: Sets the constant voltage of the load.

I Limit: Sets the maximum current of the load.

Response: Sets the response speed of electronic load. There are FAST and SLOW for selection.

The value set is the same as in CC mode.

3.2.1.4 Constant Power (CP)

In constant power mode, the electronic load will follow the programmed power to sink current from the input voltage. To enter into CP mode, tap the present mode and select CP mode from the mode menu.

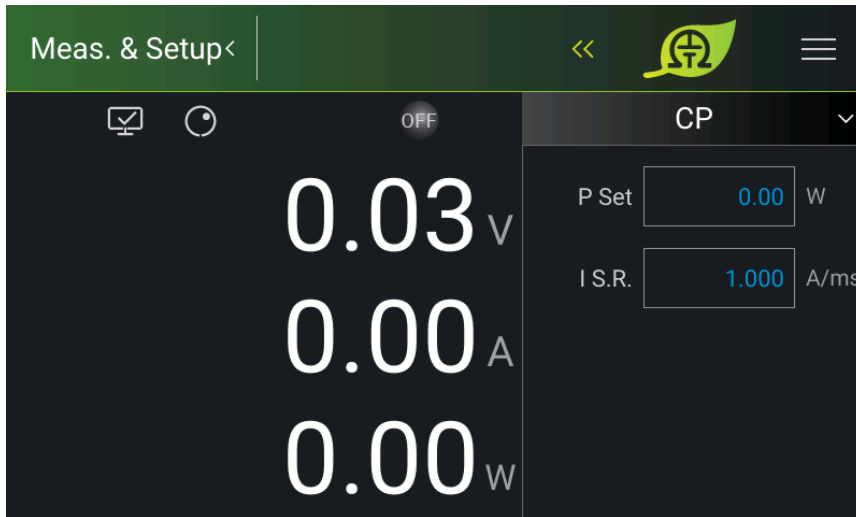

Figure 3-7

Parameters:

P SET: Sets the constant power loading parameter.

I S.R.: Sets the current rise/fall slew rate.

3.2.1.5 Constant Current Dynamic (CCD)

In CCD mode, no matter what the input voltage is, the load will dynamically sink current according to the programmed current and dynamic timing. To enter into CCD mode, tap the present mode and select CCD mode from the mode menu.

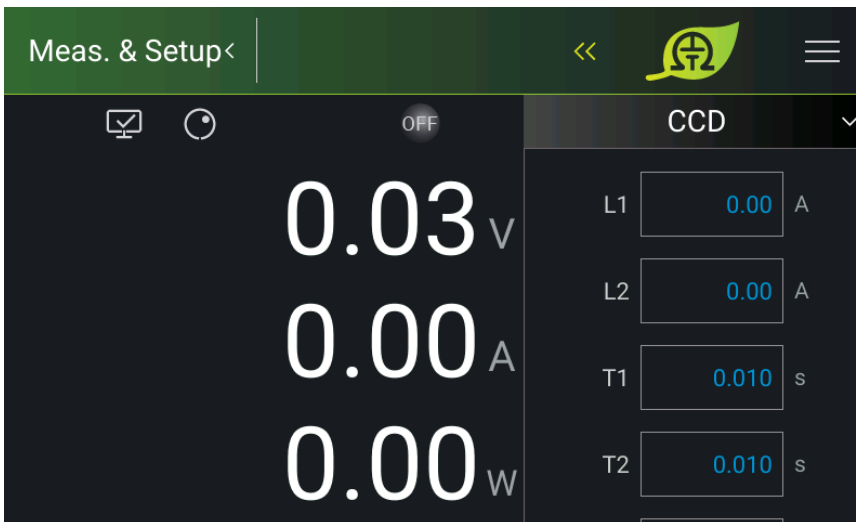

Figure 3-8

Parameters:

L1: Sets the Load1 parameter.

L2: Sets the Load2 parameter.

T1: Sets the L1 sinking time.

T2: Sets the L2 sinking time.

I S.R.: Sets the current rise/fall slew rate.

REPEAT: Sets the number of executions (0= infinite loop, 1= execute once).

3.2.2 System Setup

Tap "System Setup" in the Menu, and the screen is as Figure 3-9 shows after entering.

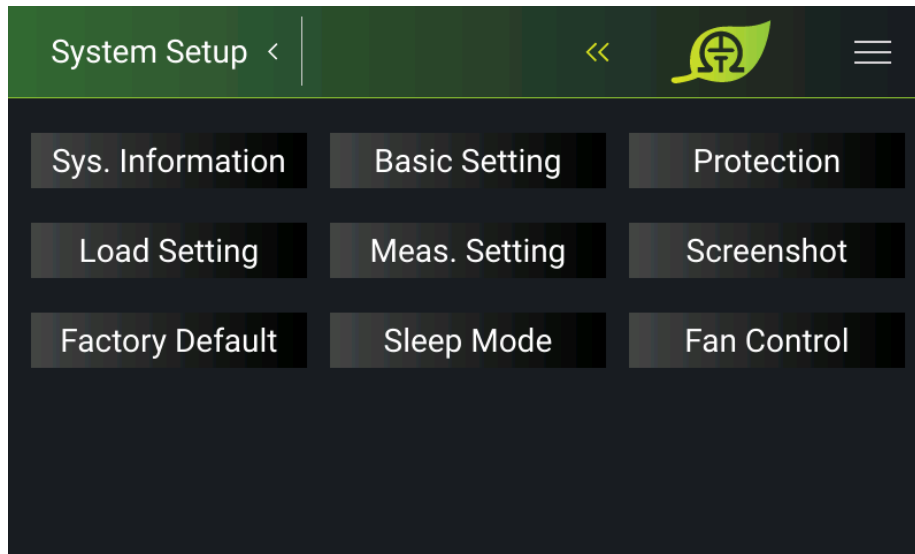

Figure 3-9

3.2.2.1 System Information

This function allows you to learn the firmware information of the DC electronic load. Tap "Sys. Information" to access it.

The display of each item is explained as follows:

Device Model	:	Displays the electronic load model no. as shown in Figure 3-10.
Serial No.	:	Displays the device serial no.
Host	:	Displays the version of D board firmware, CPLD, PCB, and UI.
AD1~AD3	:	Displays the firmware version no. of the front stage module.
DD1~DD3	:	Displays the version of rear stage module firmware, CPLD, and PCB.

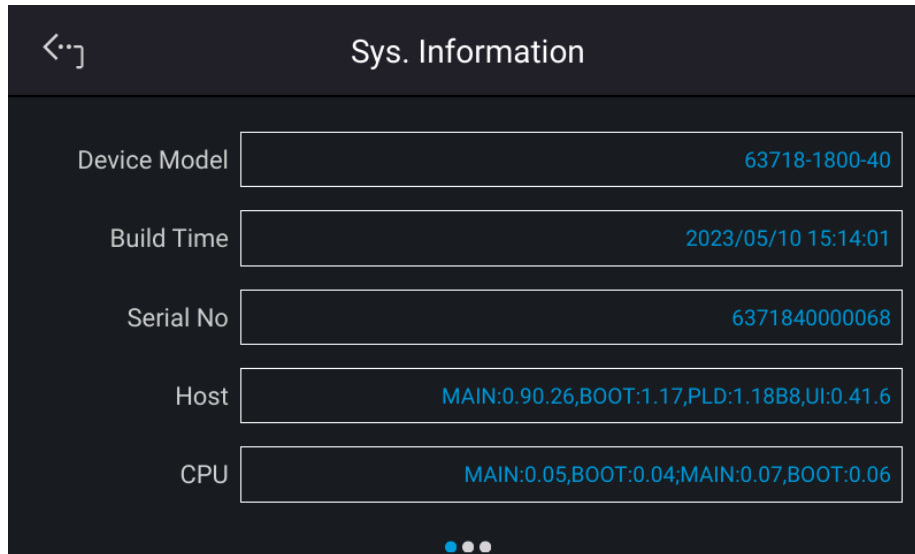

Figure 3-10

3.2.2.2 Basic Setting

This function allows you to set the brightness of the backlight, language, buzzer, time, and date. On the Menu page, tap “System Setup” and select “Basic Setting”, the screen will appear as Figure 3-11 or Figure 3-12 shows.

1. Tap Backlight to set its brightness.

 **Notice**

1. There are 3 selections for BRIGHTNESS: **HIGH /NORMAL/ DIMMED**, the default is **HIGH**.
2. The lower the backlight brightness, the longer the display panel life. Thus, it is suggested to turn the backlight brightness to **DIMMED** when the device is doing burn-in to prolong the product life of the VFD display.

2. Tap Language to set the desired language.
3. The buzzer sounds when the touch panel or the rotary knob on the front panel is tapped or turned to remind the user. It can be turned off if it is not necessary. (The default is ON.)

 **Notice**

1. BUZZER has two options: **ON / OFF**.
2. When the BUZZER is set to **ON**, press any key or turn the rotary knob will beep once to remind the user.
3. When the BUZZER is set to **ON**, the BUZZER will beep continuously if system protection occurs to remind the user.
4. When BUZZER is set to **OFF**, it will not beep in any situation.

Swipe the “Basic Setup” page left to set “Time” and “Date” in the format of hh:mm:ss and yyyy-mm-dd as shown in Figure 3-12.

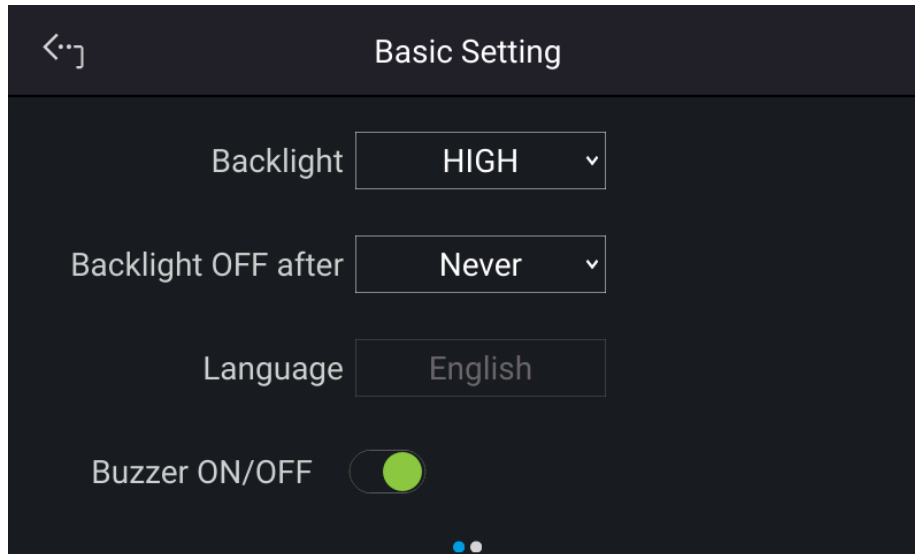

Figure 3-11

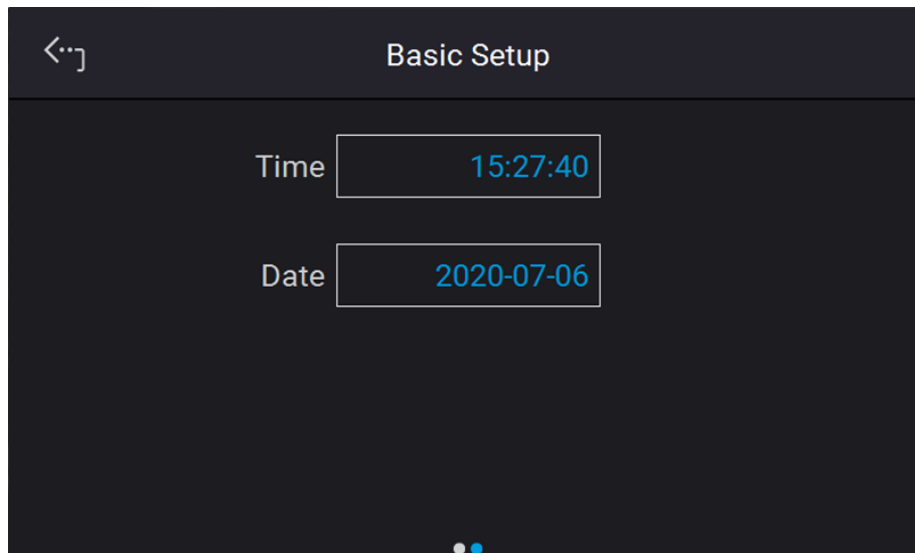

Figure 3-12

3.2.2.3 Protection

Chroma 63700 Series DC electronic loads have complete protection functions divided into two classes. The first type of protection includes over current and overpower; while the second type of protection includes over temperature, fan failure, and over/under input voltage. The first class protection trigger point is set by the user as described below, while the second class protection is auto-detected by the system hardware protection circuit.

On the “System Setup” page, select “Protection” to set each protection as shown below. The first page sets the OVP, OCP, OPP, and Foldback as Figure 3-13 shows.

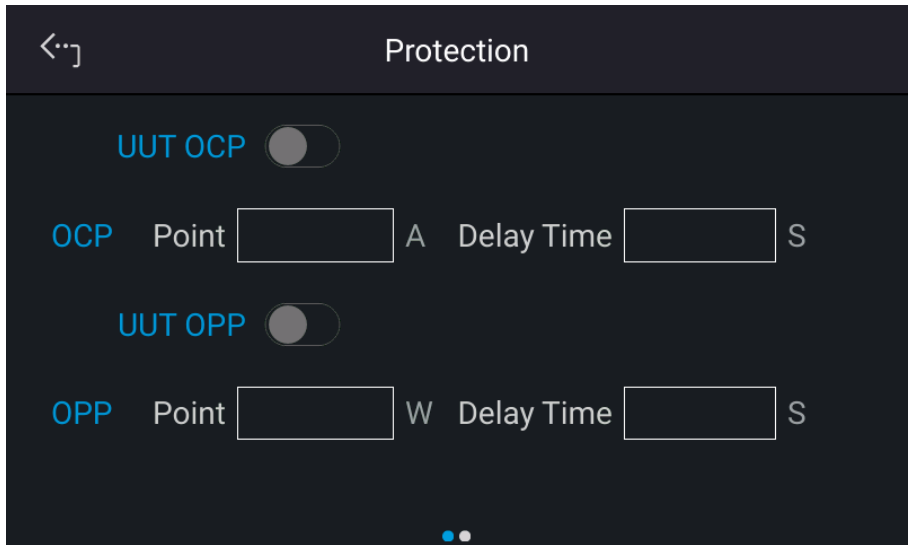

Figure 3-13

3.2.2.3.1 UUT OCP

Tap the touch panel to set UUT OCP. This function sets the protection point for Over Current. Once the loading current exceeds the range, it will turn off the output that is OUTPUT = OFF to protect the UUT.

Notice

Table 3-1 shows the current range of UUT OCP.

Table 3-1

Model	Min. OCP (A)	Max. OCP (A)
637XX	0.001 x I _{o_MAX}	1.02 x I _{o_MAX}

When UUT OCP occurs the main page will prompt a protect message as Figure 3-14 shows. Tap “Confirm” to return to the setup page.

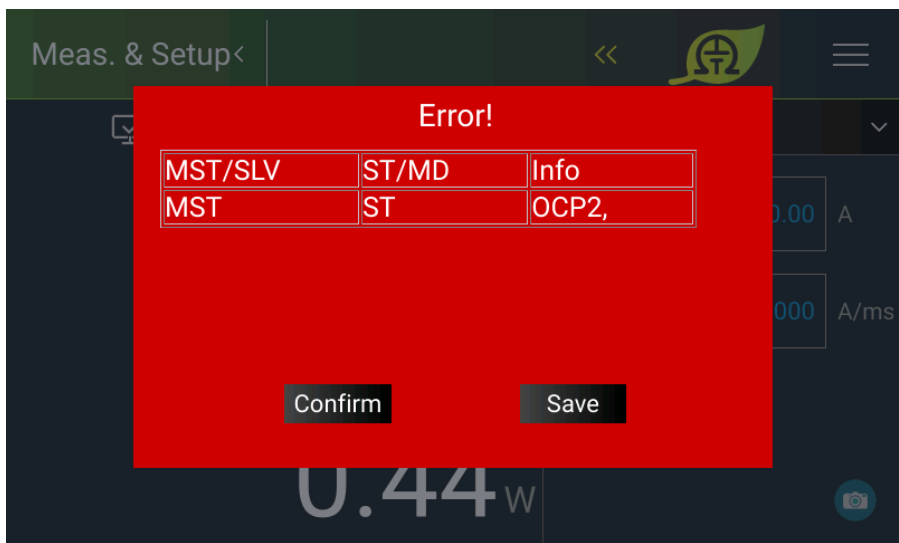

Figure 3-14

3.2.2.3.2 UUT OPP

Tap the touch panel to set UUT OPP. This function sets the protection point for Over Current. Once the output current exceeds the range, it will turn off the output that is OUTPUT = OFF to protect the UUT.

Notice Table 3-2 shows the current range of UUT OPP.

Table 3-2

Model	Min. OCP (A)	Max. OCP (A)
637XX	0.001 x Po_MAX	1.03 x Po_MAX

When UUT OPP occurs the main page will prompt a protect message as Figure 3-15 shows. Tap “**Confirm**” to return to the setup page.

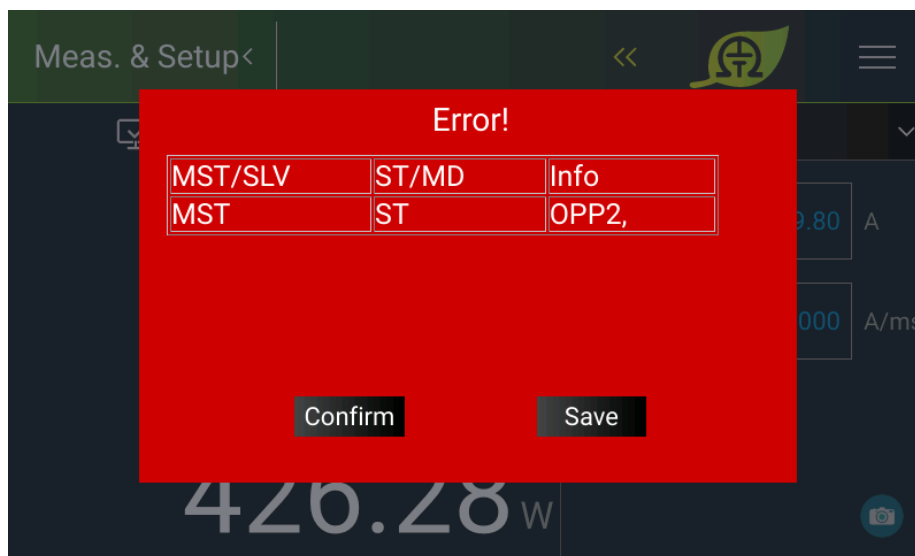

Figure 3-15

3.2.2.3.3 SAFETY INT.LOCK

This function allows the user to use Pin 3 (Interlock) of the ANALOG INTERFACE to control the Electronic Load to be temporarily OFF.

1. Tap Safety Inter Lock to set it to ON or OFF as Figure 3-16 shows.

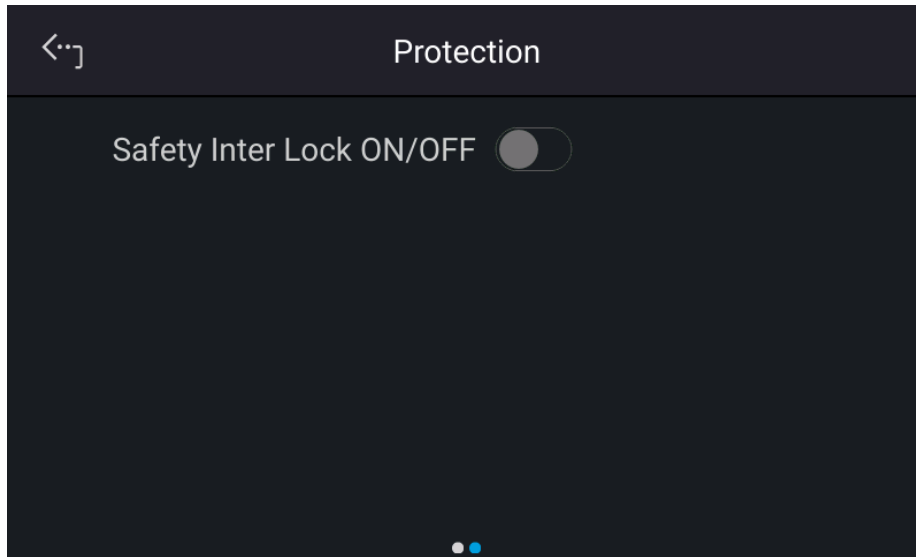



Figure 3-16

(1) Set to OFF: It disables this function.

(2) Set to ON: The ON/OFF of the Electronic Load is controlled by the “” button. When Pin 3 of the ANALOG INTERFACE is at a low level, it means the Electronic Load can output normally. When Pin 3 of the ANALOG INTERFACE is in High Level, the Electronic Load's output will be closed temporarily (the “” button is still on) and send out a protection signal. Once Pin 3 of the ANALOG INTERFACE returns to the low level, the Electronic Load will continue to output normally.

2. When protection occurs to Safety InterLock, the main screen will display the protection information, as shown in Figure 3-17.

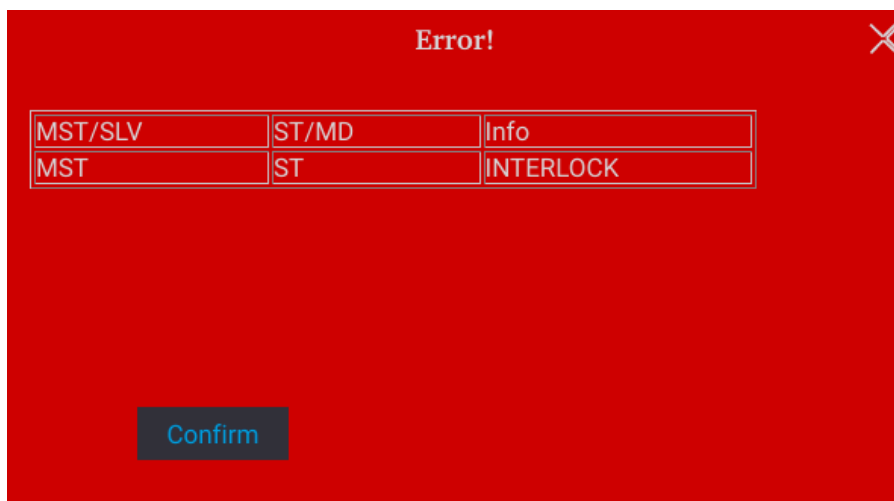

Figure 3-17

3. Pin 3 is the TTL Level input pin and its initial state is PULL=HIGH.

4. When the Electronic Load is set to OUTPUT = ON, the detailed action of Safety InterLock is shown in Figure 3-18.

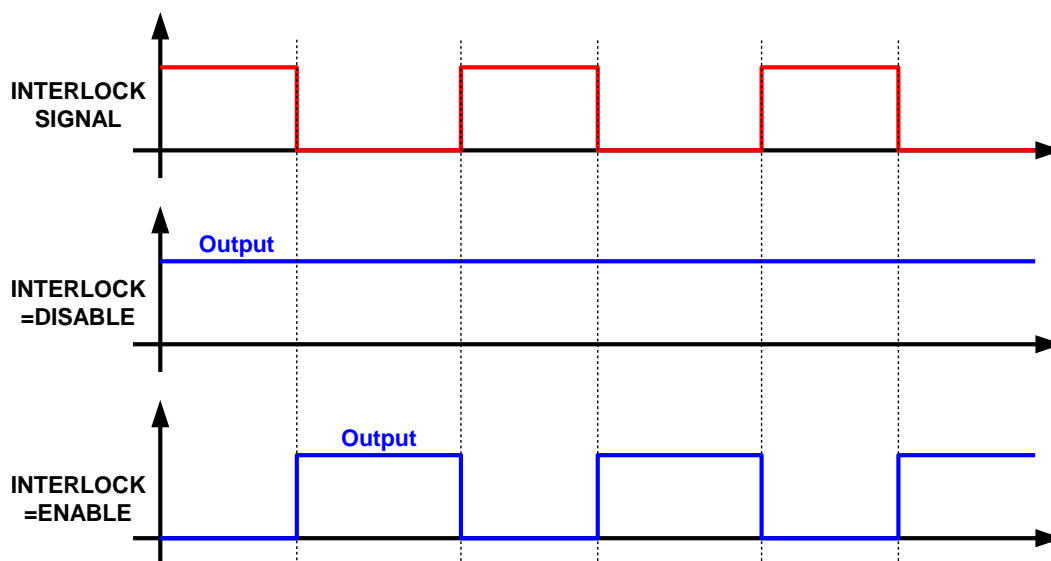

Figure 3-18

3.2.2.4 Load Setting

This function is mainly for the user to set the load timing of the Electronic Load. Tap Load Setting to set the DC electronic load. Von/off Point is the minimum operating voltage of each model by default.

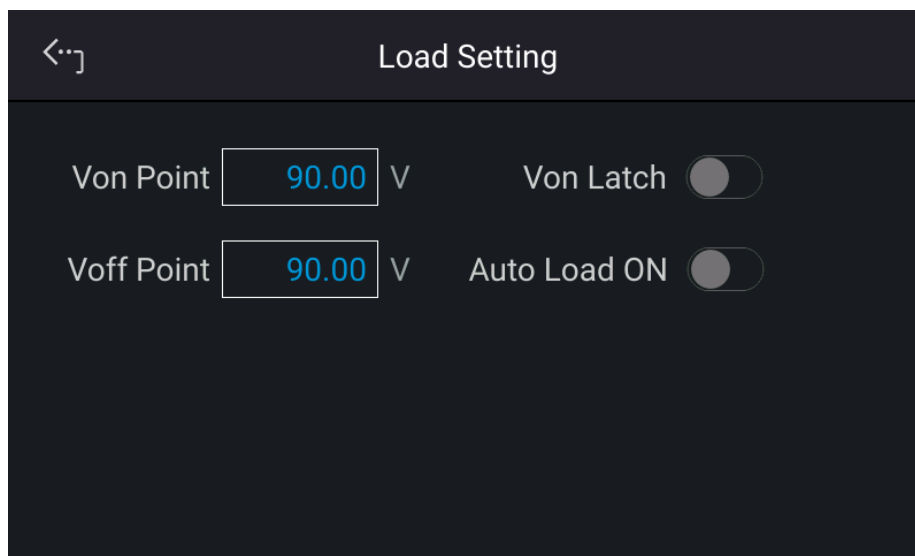

Figure 3-19

Von Point, set the start loading voltage level

The current will start loading when the electronic load is in the Load ON state and the UUT output voltage reaches the start loading voltage level (Von).

Von LATCH, lock the start loading voltage

Latch ON means the Load will continue loading current when it reaches Von. Latch OFF means the loading current will stop when the UUT voltage is lower than Von. The Von latch default is OFF.

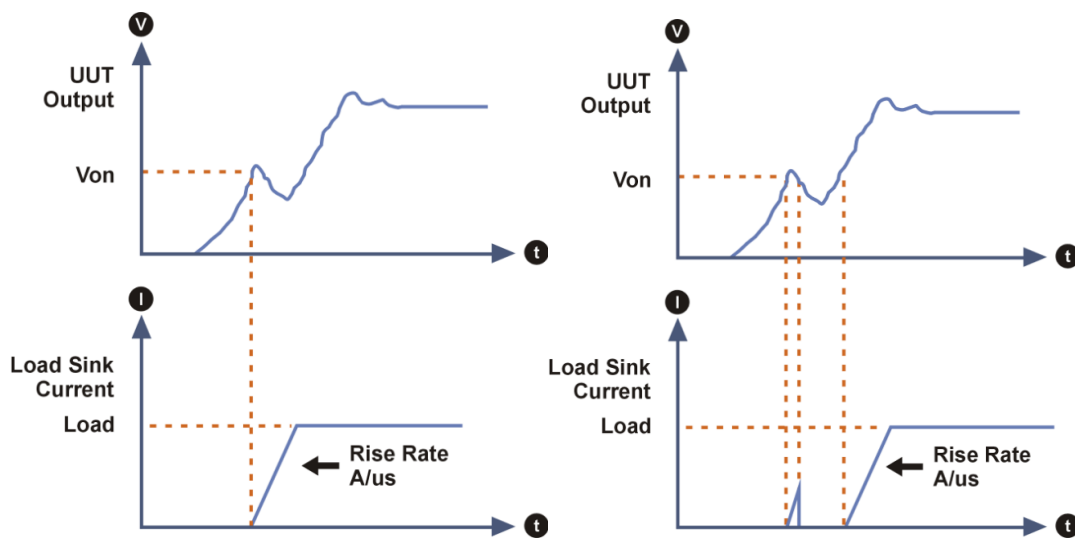

Figure 3-20 Von LATCH ON Current Waveform Von LATCH OFF Current Waveform

Voff Point, set the unload voltage level

The electronic load will close the loading state (Load OFF) when the UUT output is dropped to Voff. The default Voff voltage is the minimum working voltage of the electronic load.



CAUTION

1. The electronic load can simulate the loading conditions. When the UUT output voltage reaches Von, the electronic load will start or stop the loading current. The electronic load starts loading current when it is ON and the input voltage exceeds Von and stops loading when it is OFF or the input voltage is lower than Von. To avoid logic errors, Voff should be smaller than or equal to Von.
2. If Von_POT is set lower than the UUT minimum operating voltage, it could cause the UUT unable to turn on or to generate overshoot voltage or current when the load is set too high. Therefore, it is necessary to consider if the UUT minimum operating voltage spec is met when setting Von_POT.
3. Voff can only be used when the Von latch is on. Please note that Voff must be lower than Von.
4. When it sinks during Load on standby, the external voltage changing too fast may cause the electronic load to fail to respond and load over current triggering OPP, OCP protection.

AUTO ON, set for auto loading at power on

When Auto is on, the electronic load will apply the loading parameters and mode set last time before turning off for loading when powering on next time. The default is OFF.

3.2.2.5 Meas. Setting

Tap Meas. Setting to enter into the setup page as Figure 3-21 shows and set Average Time and Average Method respectively.

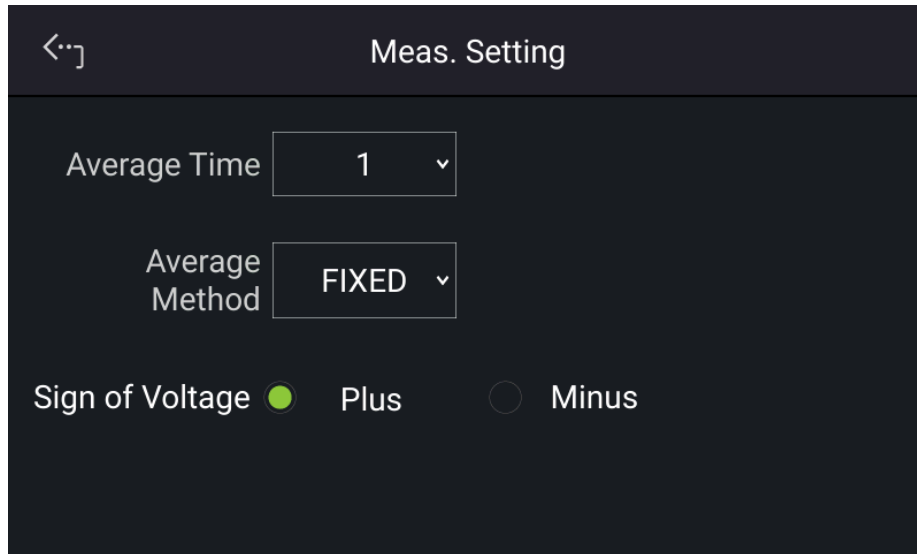

Figure 3-21

1. The way to change the reading average times is shown in Figure 3-22.

Tap the touch screen to set the desired average times. The reading average time can be set to 1, 2, 4, and 8.

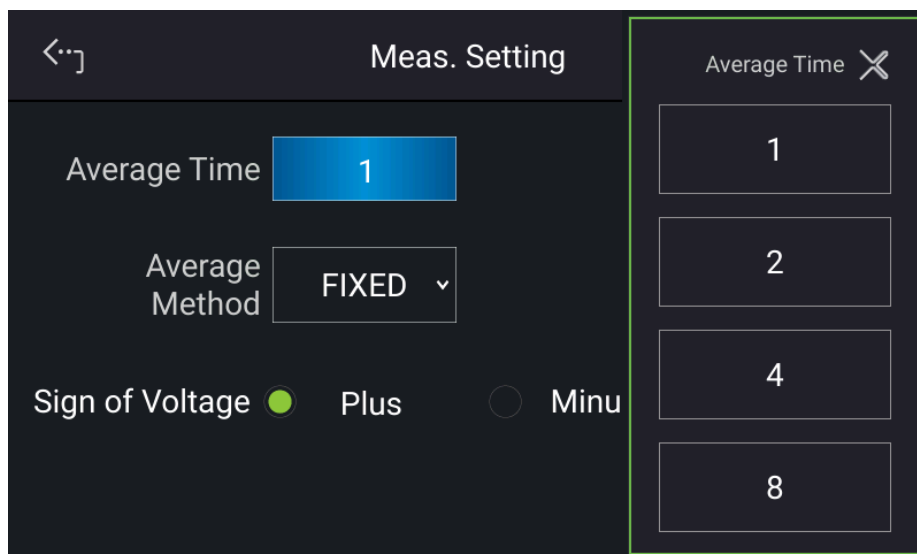

Figure 3-22

Notice

1. Assuming the reading average time is set to = 8, the average method is set to FIXED, readings sampling is that the device clears all of the old samples (A1 ~ A8) in the buffer and saves the new samples (B1 ~ B8), then average them in repetition as Figure 3-23 shows.

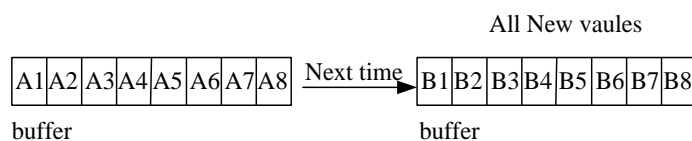

Figure 3-23

2. Assuming the reading average time is set to = 8, the average method is set to MOVING, the readings sampling is that the device removes the oldest sample in the buffer and saves a new sample, then averages them in repetition as Figure 3-24 shows.

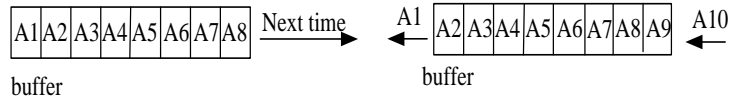

Figure 3-24

3. The panel reading is refreshed at the rate of 200ms.

2. The way to change the Average Method:

Tap the touch screen to select the desired average method. The Average Method can be set to FIXED and MOVING as shown in Figure 3-25.



Figure 3-25

3. Sign of Voltage: It sets the voltage display sign.

The voltage shows a minus sign when MINUS is set. If PLUS is set, the voltage will not show any sign. The default is PLUS.

3.2.2.6 Screenshot

Tap Screenshot to turn on or off the screen capture gadget. It allows the users to capture the desired screens such as protection or error messages and save them to USB for technical service or RD engineer use. The screen is shown in Figure 3-26 (with a small camera icon appearing in the lower right corner.)

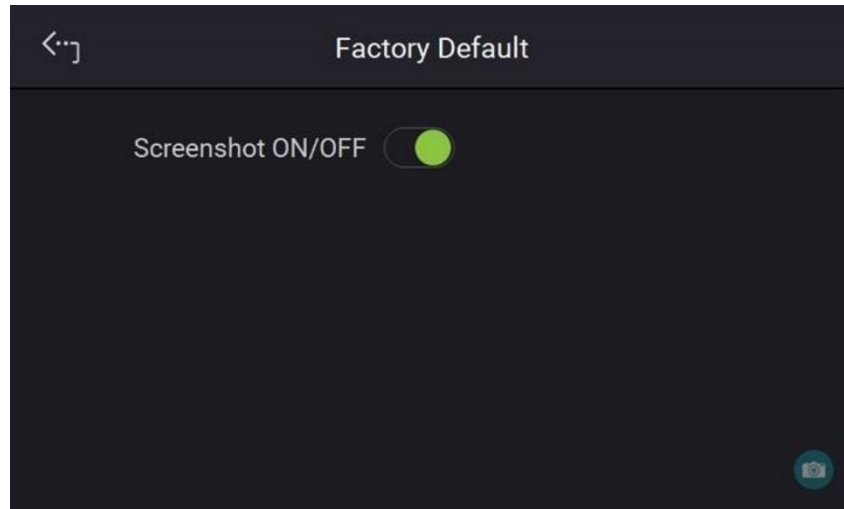

Figure 3-26

3.2.2.7 Factory Default

This function lets you reset the DC electronic load to its factory default settings.

1. On the Menu page, tap "System Setup" and select "Factory Default", the screen appears as Figure 3-27 shows.
2. Tap Recall Factory Default. A warning message will prompt as Figure 3-28 shows. It will remain the last configuration settings saved by you if No is selected, and return all configurations to the factory default if Yes is selected.

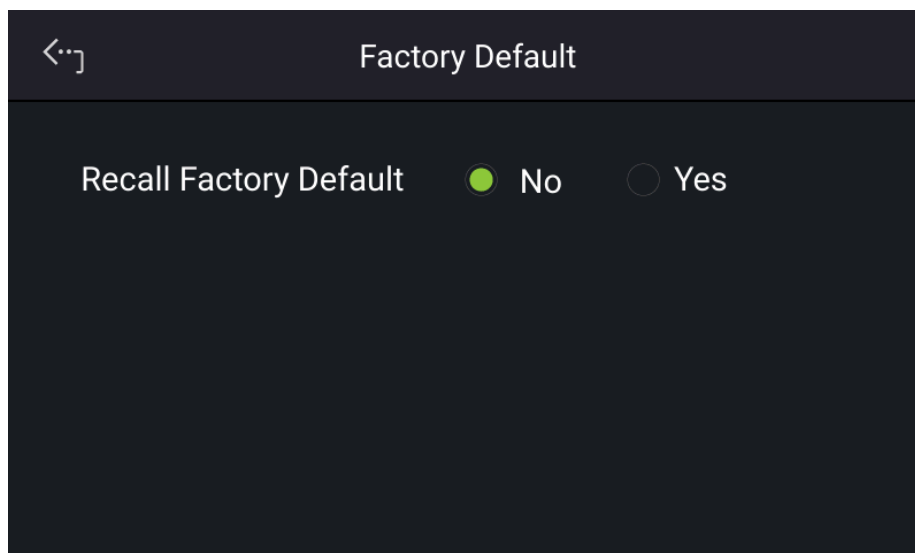

Figure 3-27

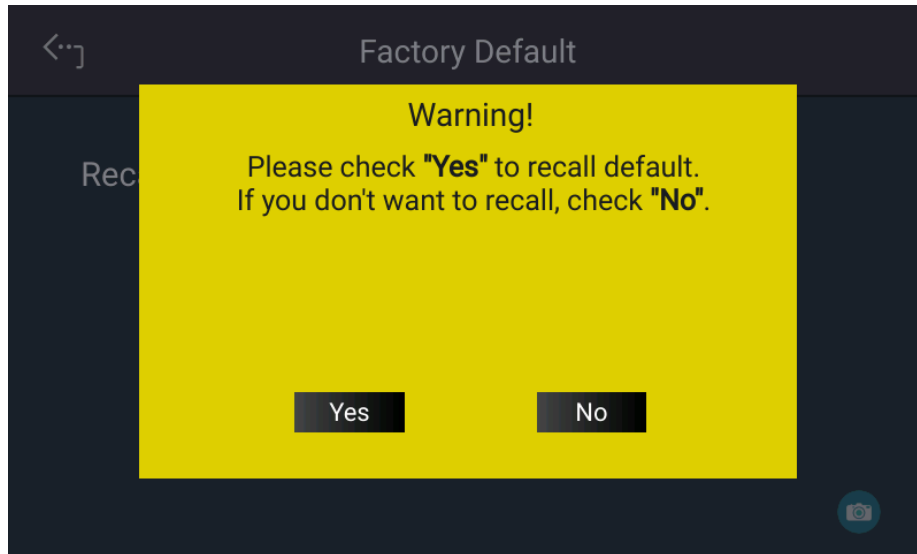

Figure 3-28

3.2.2.8 Sleep Mode

This function allows the electronic load to enter sleep mode and reduce energy consumption when it is in standby mode for a long time without any action. Tap Sleep Mode to enable it and set the time to enter the mode as the figure shown below.

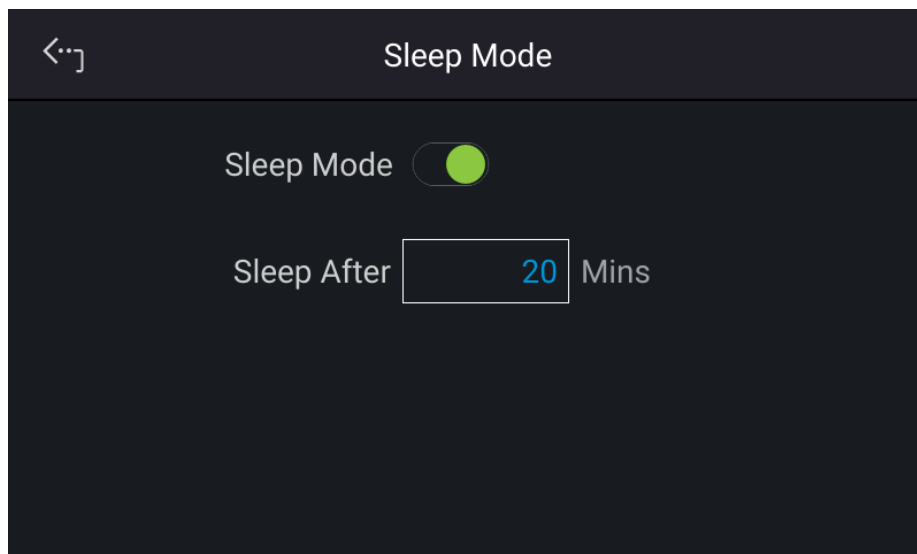

Figure 3-29

3.2.2.9 Fan Control

The default mode is Normal. Suppose the electronic load is used in a harsh environment and the air inlet filter is easily clogged with dust. In that case, it is recommended to use Strong mode to increase the fan speed to avoid over-temperature protection from occurrence.

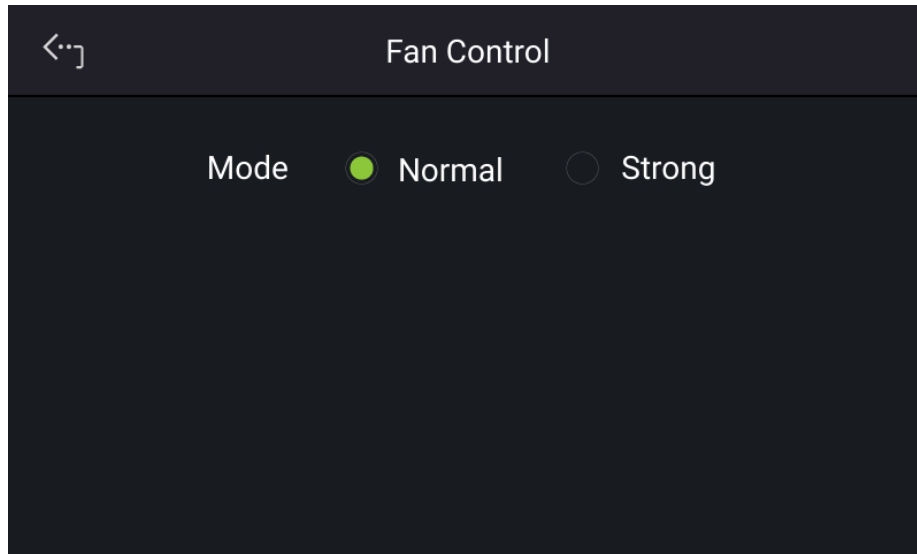

Figure 3-30

3.2.3 Configuration

3.2.3.1 Interface

Tap Configuration on the Menu page and select Interface as shown in Figure 3-31 and Figure 3-32.

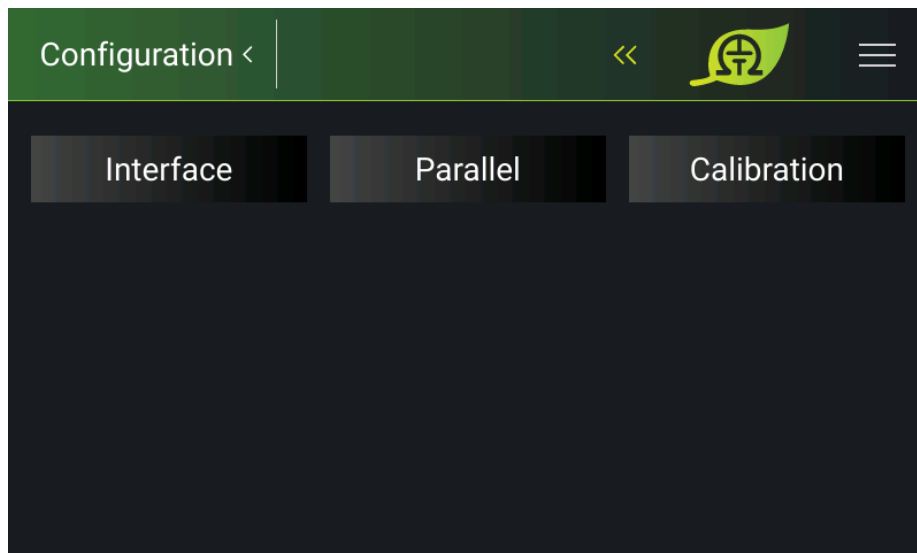

Figure 3-31

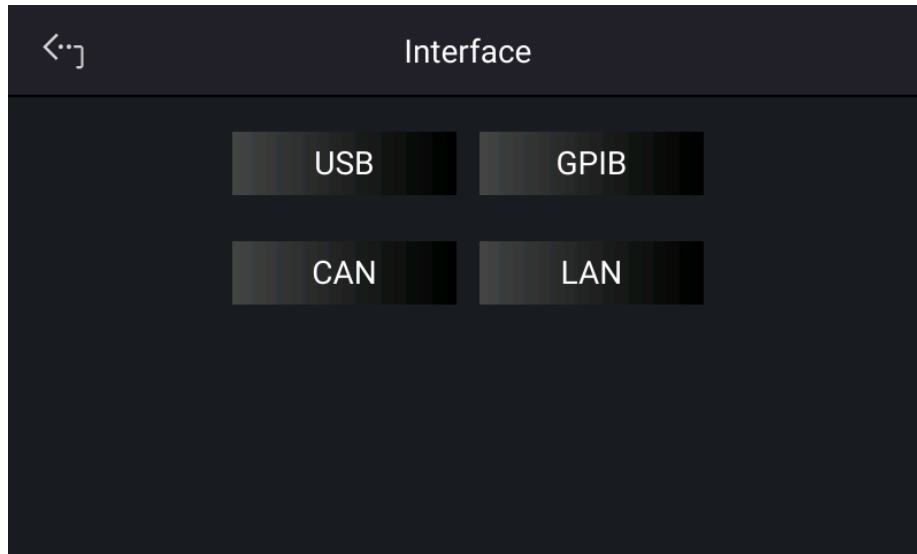

Figure 3-32

3.2.3.1.1 LAN

This DC electronic load uses LAN to provide remote operation. The LAN address is required for remote operation.

Notice

1. The user needs to connect the network cable to the DC electronic load for auto-detection.
2. If the network cable is not connected properly, it may cause the DC electronic load screen to show abnormally. Turn off the DC electronic to resolve the network cable problem and reboot it to clear the abnormal screen.

1. Tap "Menu", "Configuration" and "Interface:" to select LAN as shown in Figure 3-33 and Figure 3-34
2. Tap LAN to enter into the address setting screen.

Auto Detect:

The default of DHCP is ON. Swipe left to the second page as Figure 3-34 shows, the DC electronic load will automatically detect the external network address.

Manual Detect:

1. Tap DHCP to set it to OFF.
2. Tap IP ADDR and set it.
3. Tap SUBNET MASK and set it.
4. Tap GATEWAY ADDR, and set it.
5. Swipe left to the second page, tap "Apply" and wait for the connection.
6. Touch the upper left corner to enter the Menu page.
7. Tap "MEAS. & Setup" to return to the main page.

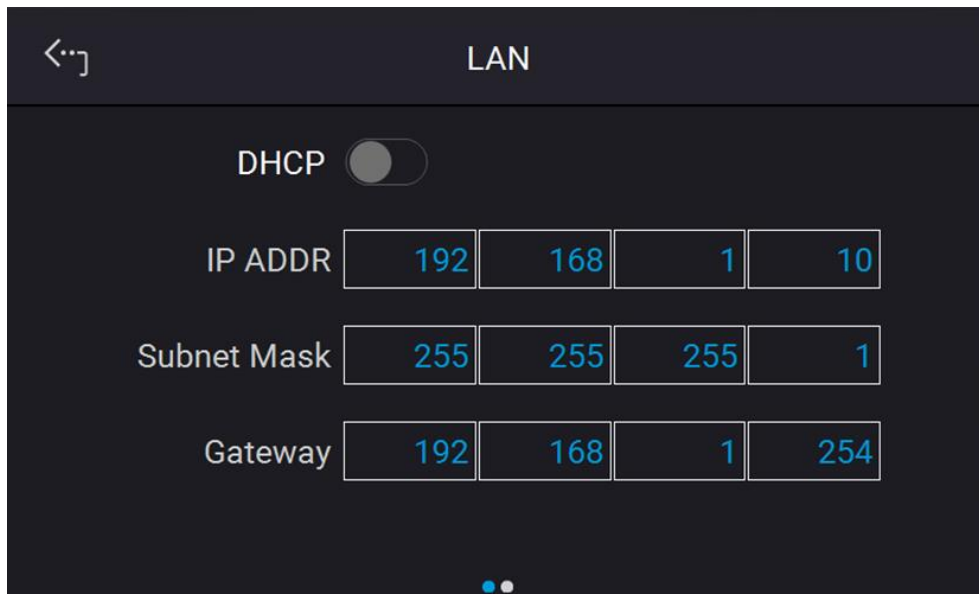

Figure 3-33

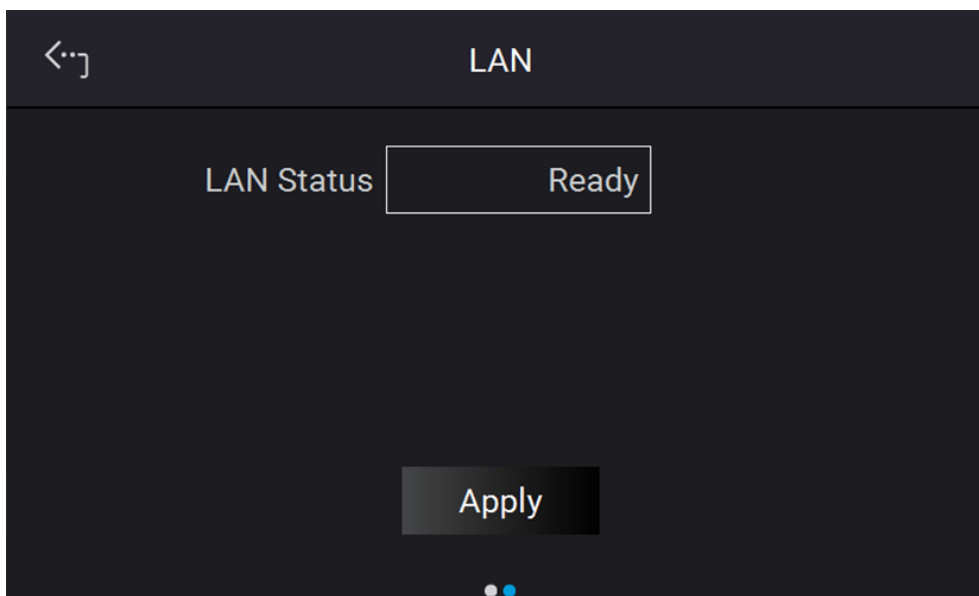

Figure 3-34

 **Notice**

1. The LAN STATUS is displayed automatically in the following 5 types:
 CONNECTED: It means the network is connected.
 CONNECTING. . . .: It means the network is connecting.
 NONE CONNECT: It means the network is not connected.
 SETTING. . . .: It means the network is under the setting.
 ETHERNET MODULE FAIL: It means the network module has failed.
 DUPLICATE_IP: It means that there is a device IP conflict.
2. The ETHERNET IP address is 0~255. In the ETHERNET setting, DHCP=ON will get the address automatically and DHCP=OFF will get the address manually. Once the IP address is set, it needs to set APPLY=YES for the address to be in effect.

3.2.3.1.2 GPIB

This DC electronic load supports remote operation via the GPIB function. It is necessary to set the GPIB address before operating remotely.

1. On the “Interface” page, select GPIB to enter the power supplies GPIB Address as shown in Figure 3-35.

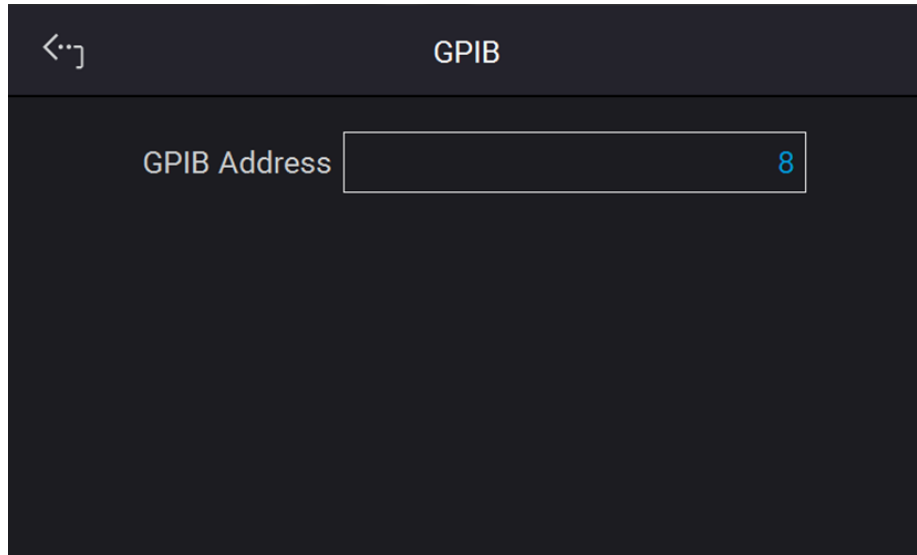

Figure 3-35

2. Tap to set the address.
3. Touch the upper left corner to enter the Menu page.
4. Tap “MEAS. & Setup” to return to the main page.



Notice

Valid GPIB addresses are in the range of 1~30.

3.2.3.1.3 CAN

The DC electronic load supports remote operation via the CAN bus. It is necessary to set the baud rate before operating remotely.

1. In the “Interface” page, select CAN as the screen shows in Figure 3-36 and Figure 3-37.
2. Tap Mode (11-bit / 29-bit mode) to set the bit number.
3. Tap Padding and set it.
4. Tap Baud and set it from the drop-down menu.
5. Tap Cyclic Time to set it.
6. Swipe left to the second page, then tap ID to set it.
7. Tap SCPI ID to set it.
8. Tap Broadcast ID to set it.
9. Tap Mask to set it.
10. Tap Cyclic ID to set it.
11. Tap Apply to execute the parameter settings.
12. Touch the upper left corner to enter the Menu page.
13. Tap “MEAS. & Setup” to return to the main page.

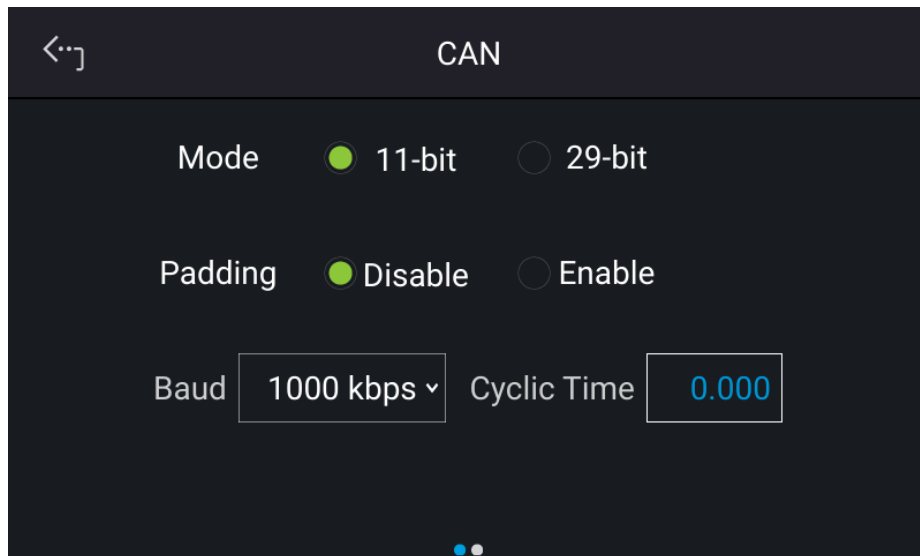

Figure 3-36



Figure 3-37

3.2.3.1.4 USB

The DC electronic load supports remote operation via the USB bus. It is necessary to query the USB address before operating remotely.

1. On the "Interface" page, select USB to enter into the USB Address screen as Figure 3-38.

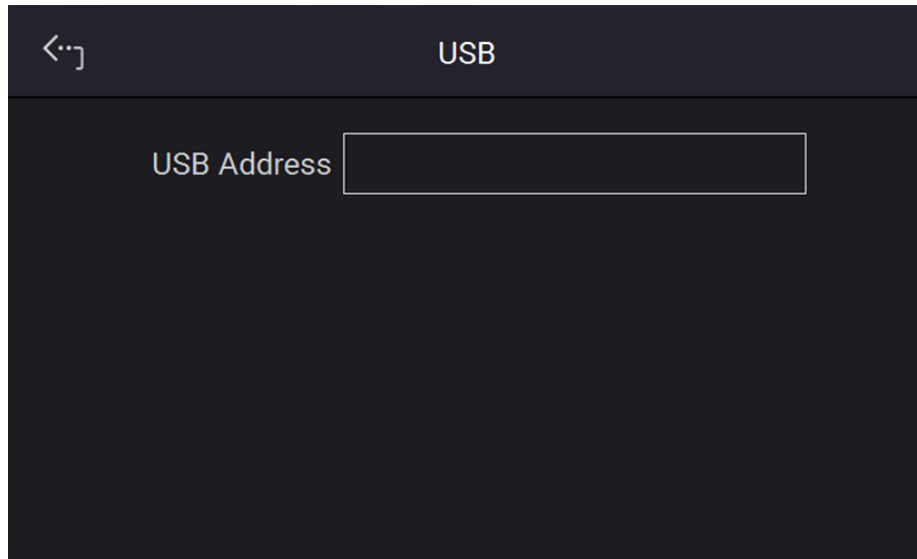

Figure 3-38

2. Touch the upper left corner to enter the Menu page.
3. Tap “MEAS. & Setup” to return to the main page.

Notice

This function is for users to query the USB Address only.

3.2.3.2 Parallel

The 63700 Series models can be operated in parallel with maximum loading up to 540A.

Notice

1. The maximum loading current is 540A when operating the 63700 Series in parallel as shown in Table 3-3.

Table 3-3

63700 Series Model	Parallel Mode	
	Max. Devices	Max. Output Current (A)
63706-100-180	3	180
63712-100-360	3	360
63718-100-540	3	540
63706-600-40	3	120
63712-600-80	3	240
63718-600-120	3	360
63712-1200-40	3	120
63718-1200-40	3	120
63718-1800-40	3	120

2. Different models cannot be operated in parallel.
3. Verify facility breaker capacity is large enough and that the earth wire is grounded to earth ground when series/parallel is in use.
4. The same model in the 63700 Series can be connected in parallel. The maximum number of devices is 3 units. When the parallel devices are more than 3, please contact CHROMA’s sales rep. or agents.

3.2.3.2.1 Output Connection in Parallel

The output connections for connecting three DC electronic loads in parallel are shown in Figure 3-39.

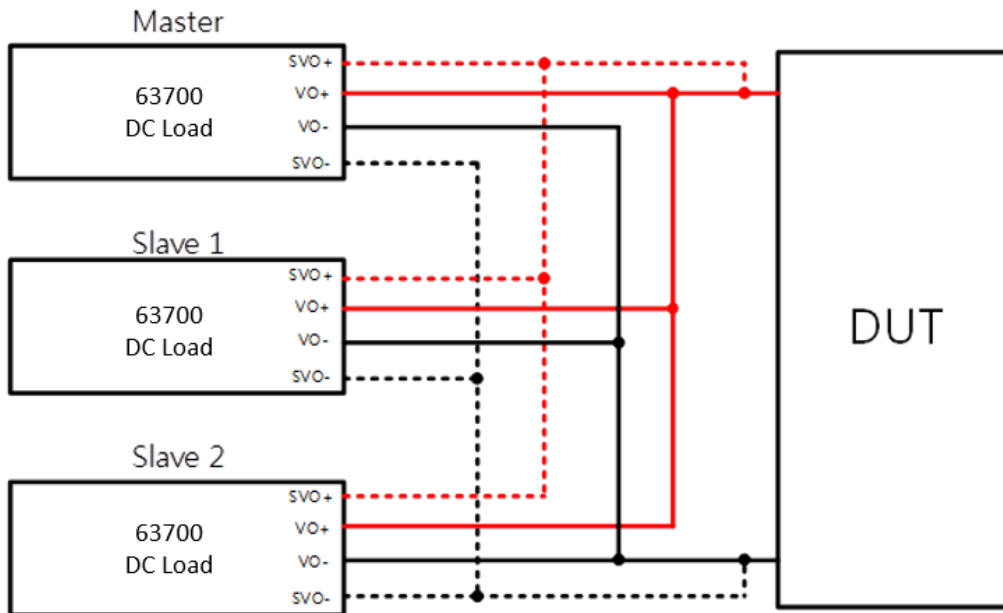

Figure 3-39

3.2.3.2.2 Installing Parallel Communication Interface

1. When two DC electronic loads are connected in parallel, the DisplayPort connector (W38-000418) on the rear panel must be connected as shown in Figure 3-40.

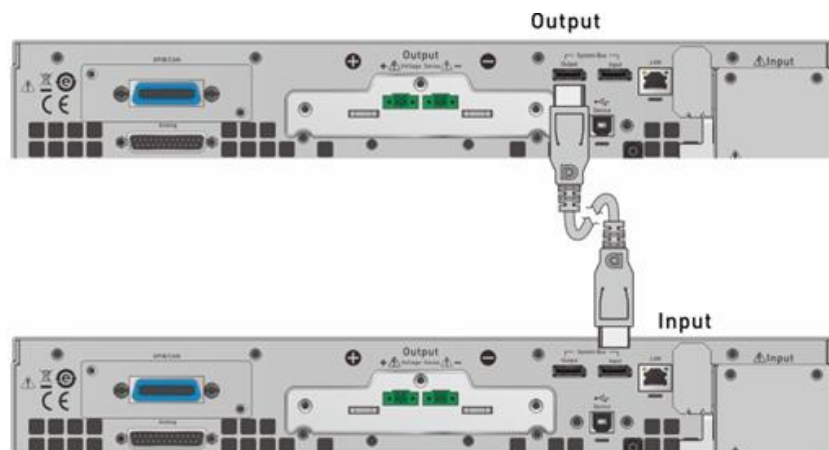

Figure 3-40

2. When three DC electronic loads are connected in parallel for operation, the DisplayPort connector on the rear panel must be connected as shown in Figure 3-41.

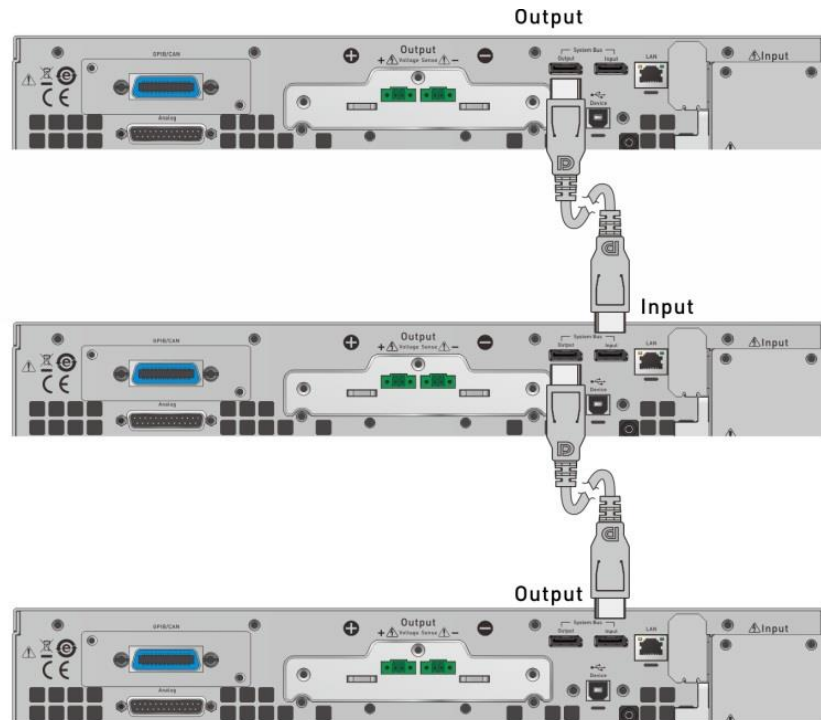

Figure 3-41

Notice

Each DC electronic load has two DisplayPort female sockets and there is no difference between left and right connection ports but connected in series as shown in Figure 3-40 or Figure 3-41. The communication cable has a limit of 5 meters in length, do not exceed this limit to avoid an unstable signal. The DisplayPort communication cable connected to the last DC electronic load does not connect back to the first DC electronic load.

Note: The DisplayPort communication cable must be 1.2 meters or longer.

WARNING

If it is necessary to return to single unit mode from the parallel mode for operation, the DisplayPort connection must be removed or the single unit will not work normally.

3.2.3.2.3 Setting Parallel Operation Mode

CAUTION

It is necessary to set SLAVE first and MASTER last when operating the 63700 Series electronic load in parallel mode, or a communication error may result.

1. On the Menu page, tap “Configuration” → “Series & Parallel” and the screen will appear as Figure 3-42.
2. Select Parallel in Connection Mode.
3. Select the Type to be Master or Slave.
4. Master+ = this indicates that one Slave unit is connected to the master
5. If M/S Control is enabled, it means the parallel connection control is in execution.

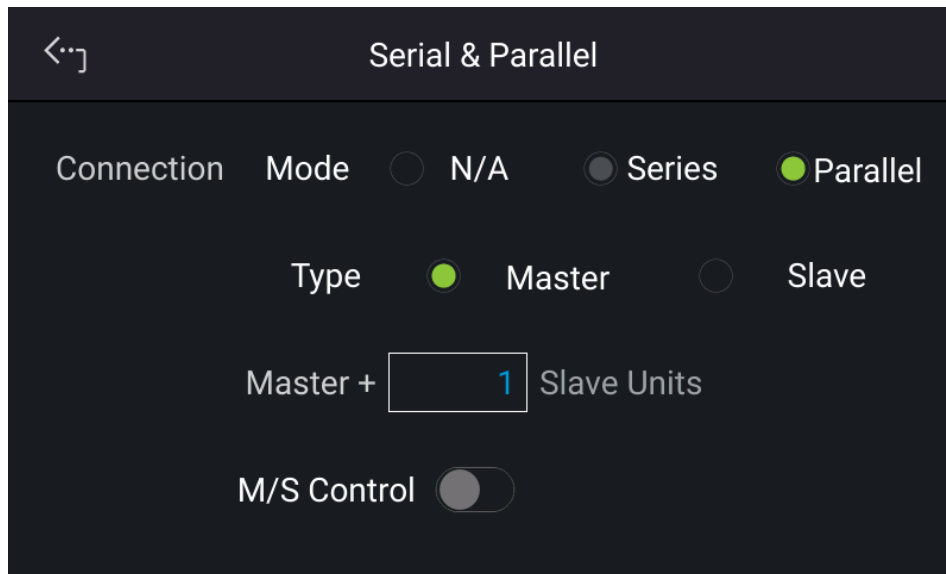

Figure 3-42

Notice

When multiple DC electronic loads are connected in parallel, only one DC electronic load can be the Master and the rest have to be set to Slave.

Notice

For example:

1. If there are 3 sets connected in parallel and 120A is set, the setting of each set is 40A and the total loading will be 120A.
2. The total sets for connecting in parallel are 3; therefore, the maximum number of Master+ is 3.

3.2.3.2.4 Parallel Mode Connection

1. When the parallel communication interface is installed, follow the steps described in the previous section to enter the Parallel page as Figure 3-43 shows.
2. Set one unit to Master and the other to Slave mode.
3. When paralleling two units set Master+ as shown in Figure 3-43.
4. After the above settings are made, M/S Control should be enabled to perform parallel connection control. When the connection is successful, the Master device displays an icon boxed in red as Figure 3-43 shows while the Slave device displays as Figure 3-44 shows.

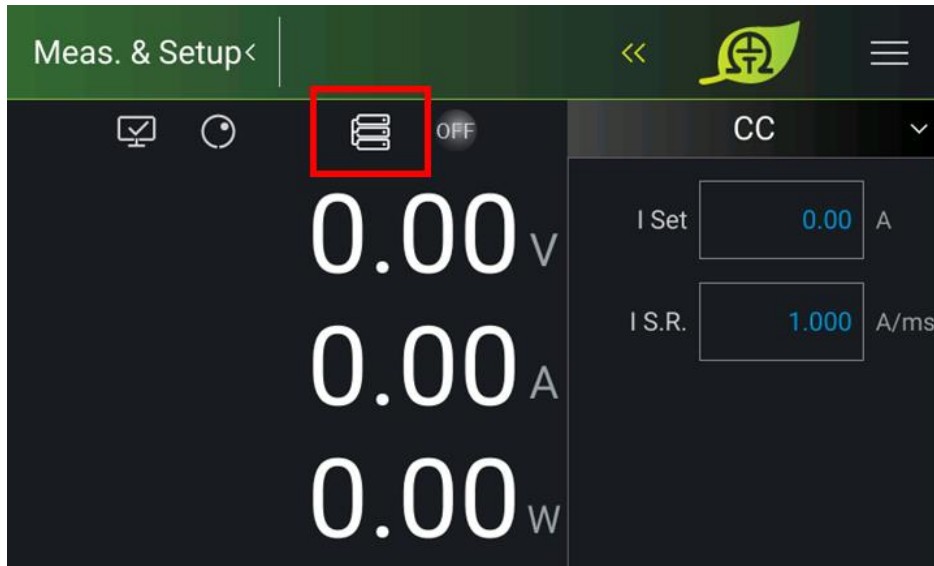

Figure 3-43

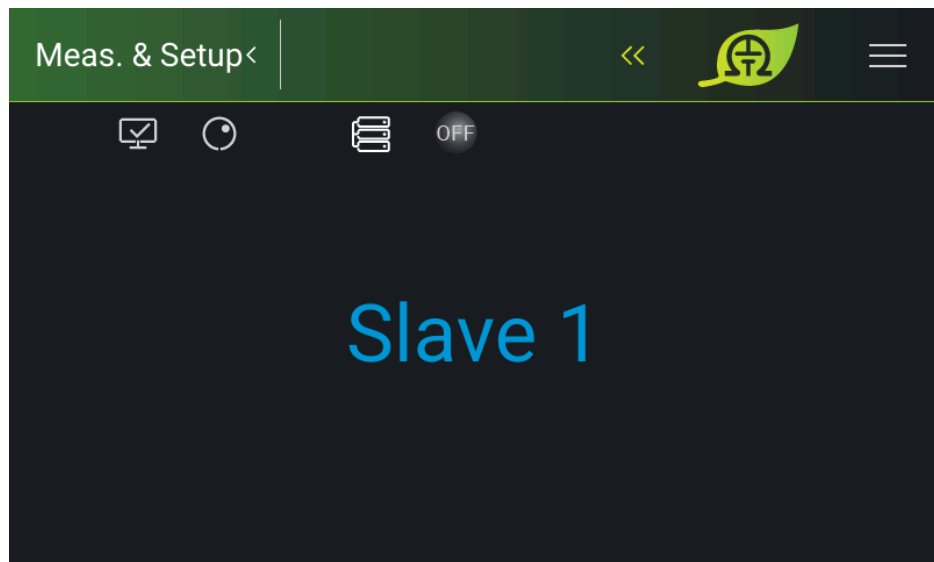

Figure 3-44

4. Remote Operation

4.1 Overview

The 63700 Series Regenerative DC Electronic Load can be controlled remotely via USB, GPIB, or Ethernet.

The USB interface supports USB 2.0/USB 1.1. GPIB interface is an 8-bit parallel data bus that synchronizes with the host bus commands. The Ethernet interface is used in the local area network for data transmission.

4.1.1 USB Interface

- | | |
|------------------------|--|
| (1) Hardware Support: | USB 2.0 and USB 1.1 |
| (2) Software Support: | USBTMC class and USB488 subclass |
| (3) OS Support: | Windows 98/ 2000 / XP / Vista /Windows 7 / Windows 8 /
Windows 10 |
| (4) Installing Driver: | 63700 Series USB Interface supports USBTMC, so if the PC OS supports USBTMC (installed NI-VISA runtime version 3.00 or above) there is no need to install other drivers. The OS will search for the standard USBTMC driver installation program automatically. |

If the PC's operating system does not support USBTMC, it is suggested to install the NI-VISA runtime version 3.00 or above first. When the installation of NI-VISA runtime is done, the USBTMC driver program is stored in the operating system. The PC can communicate with the 63700 Series via NI-VISA after using the USB.

Related Documents:

1. USB Test and Measurement Class (USBTMC) specification, Revision 1.0, www.usb.org
2. USB Test and Measurement Class USB488 subclass specification, Revision 1.0, www.usb.org

4.1.2 Setting GPIB and Ethernet Parameters



See section 3.2.3.

4.1.3 Ethernet Remote Control

To remote program a 63700 Series Regenerative DC Electronic Load via a PC with an Ethernet interface, the electronic load needs to confirm the IP address, Gateway address, and Subnet mask in advance. To ensure reliable data transmission, TCP is used for data transmission and the communication port is 5025.

4.2 GPIB Function of 63700 Series

Table 4-1

GPIB Function	Description
Talker/Listener	Command and response messages can be sent and received via the GPIB bus. Status information can be read using a series of polls.
Service Request	It sets the SRQ line to true if there is an enabled service request condition.
Remote/Local	Power-on in Local mode, the front panel can be operated, and the commands are responded via GPIB. When in Remote mode, all front panel keys are invalid except  . Long tap  to return to local mode.

4.3 Introduction to Programming

All commands and response messages are transmitted in ASCII codes. The response messages must be read completely before a new command is sent, or the remaining response messages will be lost and cause a query interrupt error.

4.3.1 Conventions

The conventions used in this section are listed in the table below.

Table 4-2

Angle brackets	< >	Items in angle brackets are parameter abbreviations.
Vertical bar		The vertical bar separates alternative parameters.
Square brackets	[]	Items in square brackets are optional. For example, OUTP[:STATe] means that :STATe may be omitted.
Braces	{ }	Braces indicate the parameters that may be repeated. The notation <A> {<, B>} means that parameter "A" must be entered while parameter "B" may be omitted or entered once or more times.

4.3.2 Numerical Data Formats

The numerical data format of the 63700 Series Regenerative DC Electronic Load is listed in Table 4-3. Numerical data can be added to the suffix to distinguish data while the multiplier can be placed before the suffix. Table 4-4 lists the suffix used by the 63700 Series Regenerative DC Electronic Load and Table 4-5 lists the multiplier.

Table 4-3 Format of Numerical Data

Symbol	Description	Example
NR1	It is a digit without a decimal point. The decimal is assumed to be at the right of the least significant digit.	123, 0123
NR2	It is a digit with a decimal point.	12.3, .123
NR3	It is a digit with a decimal point and an exponent.	1.23E+2
NRf	A flexible decimal format including NR1, NR2, or NR3.	123, 12.3, .23E+3

NRf+	An extended decimal format including NRf and MIN, MAX. MIN and MAX are the high and low limits of the parameter.	123, 12.3,1.23E+3, MIN, MAX
------	--	-----------------------------------

Table 4-4

Mode	Type	Primary Suffix	Secondary Suffix	Reference Unit
CC	Current	A		Ampere
CR	Resistance	OHM		Ohm
CV	Amplitude	V		Volt
CP	Power	W		Watt
CZ	Inductance	H		Henry
	Capacitance	F		Farad
All	Time	S		Second
All	Frequency	Hz		Hertz
All	Slew Rate	A/mS		Amperes/Millisecond

Table 4-5

Multiplier	Symbol	Definition
1E6	MA	Mega
1E3	K	Kilo
1E-3	M	Milli
1E-6	U	Micro

4.3.3 Boolean Data Format

The <Boolean> parameter uses the form ON|OFF only.

4.3.4 Character Data Format

The character strings returned by the query command are shown in either of the following forms:

- <CRD> Character Response Data: character string with a maximum length of 12.
- <SRD> String Response Data: character string.

4.3.5 Basic Definition

4.3.5.1 Command Tree Structure

The commands of the DC electronic load are based on a hierarchical structure, also known as a tree system. To obtain a particular command, the full path to that command must be specified. This path is represented in the structure by placing the highest node in the farthest left position of the hierarchy. Lower nodes in the hierarchy are indented in the position to the right, below the parent node.

4.3.5.2 Program Headers

Program headers are keywords that identify the command. They follow the syntax described in section 4.6 of IEEE 488.2. The Regenerative DC Electronic Load accepts characters in both upper and lower case without distinguishing the difference. Program headers consist of two distinctive types, common command headers, and instrument-controlled headers.

4.3.5.3 Common Command and Query Headers

The syntax of the common command and query headers is described in IEEE 488.2. It is used together with the IEEE 488.2-defined common commands and queries. The commands with a leading “ * ” are common commands.

4.3.5.4 Instrument-Controlled Headers

Instrument-controlled headers are used for all other instrument commands. Each of them has a long form and a short form. 63700 Series only accepts the exact short and long forms. A special notation will be taken to differentiate the short form header from the long one of the same header in this subsection. The short-form header is shown in characters of upper case, whereas the rest of the headers are shown in lower case.

4.3.5.5 Program Header Separator (:)

If a command has more than one header, the user must separate them with a colon (FETC:CURR FUNC:SHAP). Data must be separated from the program header in one space at least.

4.3.5.6 Program Message

The program message consists of a sequence of zero or other elements of the program message unit that are separated by separator elements of the program message unit.

4.3.5.7 Program Message Unit

The program message unit represents a single command, programming data, or query.

Example: VOLT?, OUTPut ON.

4.3.5.7.1 Program Message Unit Separator (;)

The separator (semicolon ;) separates the program message unit from one other element in a program message.

Example: VOLT 80; CURR 15<PMT>

4.3.5.7.2 Program Message Terminator (<PMT>)

A program message terminator represents the end of a program message. Three permitted terminators are:

- (1) <END> : end or identify (EOI)
- (2) <NL> : new line which is a single ASCII-encoded byte 0A (10 decimals).
- (3) <NL> <END> : new line with EOI.



The response message is terminated by <NL> <END> for GPIB.

4.4 Traversal of Command Tree

Multiple program message unit elements can be sent in a program message. The first command is always referred to as the root node. Subsequent commands are referred to the same tree level as the previous command in a program message. A colon preceding a program message unit changes the header path to the root level.

Example:

CURRent:STATic:SLEW 1	All colons are header separators.
: CURRent:STATic:SLEW 1	Only the first colon is a specific root.
CURRent:STATic:SLEW 1;: CURRent:STATic 100	Only the third colon is a specific root.

4.5 Execution Order

The 63700 Series Regenerative DC Electronic Load executes program messages by the order received. Program message units except coupled commands are executed in order of reception. The execution of coupled commands is deferred until the program message terminator is received. A coupled command sets parameters, which are affected by the setting of other commands. Problems may arise because the prior state of the 63700 Series Regenerative DC Electronic Load will affect the response of a coupled parameter to its programming.

4.6 Commands

This section describes the syntax and parameters of all commands for DC electronic load.

*CLS	Clear status command
*ESE	Standard event status enable
*ESR?	Standard event status register
*IDN?	Identification query
*OPC	Operation complete command
*OPC?	Operation complete query
*RCL	Recall instrument state command
*RST	Reset command
*SAV	Save command
*SRE	Service request enable command/query

*STB?	Read status byte query
ABORT subsystem	
ABORt	Sets all output states to "OFF".
CONFIGURE subsystem	
CONFigure:BRIGhtness	Sets the display brightness of the panel.
CONFigure:BEEPer	Sets beeper to ON or OFF.
CONFigure:OCP	Sets the OCP detection to enable or disable.
CONFigure:OCP:POINt	Sets the OCP point.
CONFigure:OCP:DELay	Sets the OCP time delay.
CONFigure:OPP	Sets the OPP detection to enable or disable.
CONFigure:OPP:POINt	Sets the OPP point.
CONFigure:OPP:DELay	Sets the OPP time delay.
CONFigure:VOLTagE:ON	Sets the Von point.
CONFigure:VOLTagE:OFF	Sets the Voff point.
CONFigure:VOLTagE:LATCh	Sets the Von Latch ON or OFF.
CONFigure:VOLTagE:LATCh:RESet	Resets the Von state when the Von Latch is turned on.
CONFigure:AUTO:ON	Sets the auto output function to ON or OFF.
CONFigure:AVG:TIMES	Sets the average number of times for input voltage and current measurements
CONFigure:AVG:METHod	Sets the average method for input voltage and current measurements.
CONFigure:VOLTagE:SIGN	Sets the input voltage sign display to be PLUSor MINUS.
CONFigure:MSTSLV:ID	Sets the device to Master.
CONFigure:MSTSLV:PARSER	Sets to series or parallel mode.
CONFigure:MSTSLV:NUMSLV	Sets the number of slaves to be controlled.
CONFigure:MSTSLV:READY?	Queries the Master/Slave connection status.
CONFigure:MSTSLV	Executes the Master/Slave control.
CONFigure:RECYcle:DISPlay	Switches the energy recycle display type.
CONFigure:RECYcle:INTerval:RESet	Resets the interval energy recycle record.
CONFigure:RECYcle:INTerval	Returns the interval energy recycle record.
CONFigure:RECYcle:TOTal	Returns the total energy recycle record.
MODE subsystem	
MODE	Sets the electronic load operating mode.
LOAD subsystem	
LOAD[::STATe]	Sets the electronic load to ON or OFF.
LOAD:PROTEction?	Returns the electronic protection status.
LOAD:PROTEction:CLEAr	Clears the protection on the electronic load.
CURRENT subsystem	
CURRent[::STATic]	Sets the CC mode current.
CURRent[::STATic]:SLEW	Sets the current slew rate (A/ms) in CC mode.
CURRent:DYNamic:L1	Sets the T1 duration current in CCD mode.
CURRent:DYNamic:L2	Sets the T2 duration current in CCD mode.
CURRent:DYNamic:T1	Sets the T1 time in CCD mode.
CURRent:DYNamic:T2	Sets the T2 time in CCD mode.

CURRent:DYNamic:SLEW	Sets the current slew rate (A/ms) in CCD mode.
CURRent:DYNamic:REPeat	Sets the repeated times in CCD mode.
RESISTANCE subsystem	
RESistance[:STATic]	Sets the resistance level in CR mode.
RESistance[:STATic]:SLEW	Sets the current slew rate (A/ms) in CR mode.
VOLTAGE subsystem	
VOLTage[:STATic]	Sets the voltage in CV mode.
VOLTage[:STATic]:ILIMit	Sets the current limit in CV mode.
VOLTage[:STATic]:RESponse	Sets the response to be SLOW or FAST in CV mode.
POWER subsystem	
POWER[:STATic]	Sets the power in CP mode.
POWER[:STATic]:SLEW	Sets the current slew rate (A/ms) in CP mode.
FETCH subsystem	
FETCh:VOLTage?	Measures the output terminal of electronic load and returns the real-time voltage.
FETCh:CURRent?	Measures the output terminal of electronic load and returns the real-time current.
FETCh:POWER?	Measures the output terminal of electronic load and returns the real-time power.
FETCh:STATus?	Returns the real-time status code of the electronic load.
MEASURE subsystem	
MEASure:VOLTage?	Returns the output terminal measured voltage of the electronic load.
MEASure:CURRent?	Returns the output terminal measured current of the electronic load.
MEASure:POWER?	Returns the output terminal measured power of the electronic load.
SYSTEM subsystem	
SYSTEM:ERRor?	Returns the error message and code of electronic load.
SYSTEM:VERSion:INTernal?	Queries the Host version
SYSTEM:MODule:VERSion?	Queries the module version.
SYSTEM:DATE	Sets the system date.
SYSTEM:TIME	Sets the system time.
SYSTEM:COMMunicate:CAN:CYCLic:TIME	Sets the CAN cycle time.
SYSTEM:COMMunicate:CAN:BAUD	Sets the CAN baud rate.
SYSTEM:COMMunicate:CAN:ID	Sets the CAN ID.
SYSTEM:COMMunicate:CAN:MASK	Sets the CAN ID mask.
SYSTEM:COMMunicate:CAN:MODE	Sets the CAN 11-bit / 29-bit mode.
SYSTEM:COMMunicate:CAN:PADding	Sets the CAN padding function.
SYSTEM:COMMunicate:CAN:APPLY	Updates the CAN setting.
SYSTEM:COMMunicate:GPIB:ADDRess	Sets the GPIB address.
SYSTEM:COMMunicate:SOCK:MODE	Sets the Ethernet mode.
SYSTEM:COMMunicate:SOCK:GATEway	Sets the Ethernet gateway.
SYSTEM:COMMunicate:SOCK:IP	Sets the Ethernet IP.
SYSTEM:COMMunicate:SOCK:MASK	Sets the Ethernet IP mask.

SYSTem:COMMunicate:SOCK:APPLY	Updates the Ethernet setting.
INSTRUMENT subsystem	
INSTRument:STATus:AD?	Queries the AD module status.
INSTRument:STATus:DD?	Queries the DD module status.

4.6.1 Common Command Syntax

Commands are defined by IEEE488.2 standard containing common and query commands. Common commands begin with a "*" and consist of three letters and/or one "?" (query). Common commands and queries are listed alphabetically.

***CLS Clear Status**
 Type: Device status
 Description: *CLS command acts the follows:
 Clear Error Code Reset Error Message. If "*CLS" is followed by <nl>, the "output queue" and MAV bit will be clear as well.
 Syntax: *CLS
 Parameter: None

***ESE Standard Event Status Enable**
 Type: Device status
 Description: This command sets the condition of the Standard Event Status Enable register, which determines which events of the Standard Event Status Event register (see *ESR?) are allowed to set the ESB (Event Summary Bit) of the Status Byte register. A "1" in the bit position enables the corresponding event. All of the enable events of the Standard Event Status Event register are logically ORed to cause the ESB (bit 5) of the Status Byte register to be set.
 Syntax: *ESE <NRf>
 Parameter: 0 to 255
 Example: *ESE 48 This command enables the CME and EXE events of the Standard Event Status Event register.
 Query Syntax: *ESE?
 Return Parameter: <NR1>
 Query Example: *ESE? This query returns the current setting of Standard Event Status Enable.

***ESR? Standard Event Status Register**
 Type: Device status
 Description: This query reads the Standard Event Status register and clears it.
 Query Syntax: *ESR?
 Return Parameter: <NR1>
 Query Example: *ESR? Return status readings of Standard Event Status register.
 Return Example: 48

***IDN? Identification Query**
 Type: System interface
 Description: This query requests the electronic load to identify itself.
 Query Syntax: *IDN?
 Query Example: *IDN?

String	Description
CHROMA ATE	Manufacturer

63718-1800-40 Model name
 123456 Serial No.
 01.00 Firmware version
 Return Example: Chroma, 63718-1800-40, 96218030123456,1.00

***OPC Operation Complete Command**

Type: Device status
 Description: This command causes the interface to set the OPC bit (bit 0) of the Standard Event Status register when the DC electronic load has completed all pending operations.

Syntax: *OPC
 Parameter: None

***OPC? Operation Complete Query**

Type: Device status
 Description: This query returns an ASCII "1" when all pending operations are completed.

Query Syntax: *OPC?
 Return Parameter: <NR1>
 Query Example: 1

***RCL Recall Instrument State Command**

Type: Device status
 Description: This command restores the High Slew Rate Load to a state that was previously stored in memory with the *SAV command to the specified location (see *SAV).

Syntax: *RCL <NR1>
 Parameter: None
 Example: *RCL 1

***RST Reset Command**

Type: Device status
 Description: Reset System
 Syntax: *RST
 Parameter: None

***SAV Save Command**

Type: Device status
 Description: This command stores the present state of the DC electronic load and the states of the current mode in a specified location in memory.

Syntax: *SAV
 Example: *SAV

***SRE Service Request Enable Command/Query**

Type: Device status
 Description: This command sets the condition of the Service Request Enable register, which determines which events of the Status Byte register (see *STB) are allowed to set the MSS (Master Status Summary) bit. A "1" in the bit position enables bits to be logically ORed to cause Bit 6 (the Master Summary Status Bit) of the Status Byte register to be set. See the Status Byte register for a detailed description.

Syntax: *SRE <NRf>
 Parameter: 0 to 255
 Example: *SRE 20 Enable the CSUM and MAV bit of the Service Request.

Query Syntax: *SRE?
 Return Parameter: <NR1>
 Query Example: *SRE? Return the current setting of Service Request Enable.

***STB? Read Status Byte Query**

Type: Device status
 Description: This query reads the Status Byte register. Note that the MSS (Master Summary Status) bit instead of the RQS bit is returned in Bit 6. This bit indicates if the High Slew Rate Load has at least one reason for requesting service. *STB? does not clear the Status Byte register, which is cleared only when subsequent action has cleared all its set bits.

Query Syntax: *STB?
 Return Parameter: <NR1>
 Query Example: *STB? Return the contents of Status Byte.
 Return Example: 20

Notice

1. Status Byte Register:
 The Status Byte Register is composed of eight bits that summarize an overlaying status data structure. The Status Byte Register can be read using *STB? to return a decimal expression of the register contents (which means the total byte weight of all the bytes set to "1".)

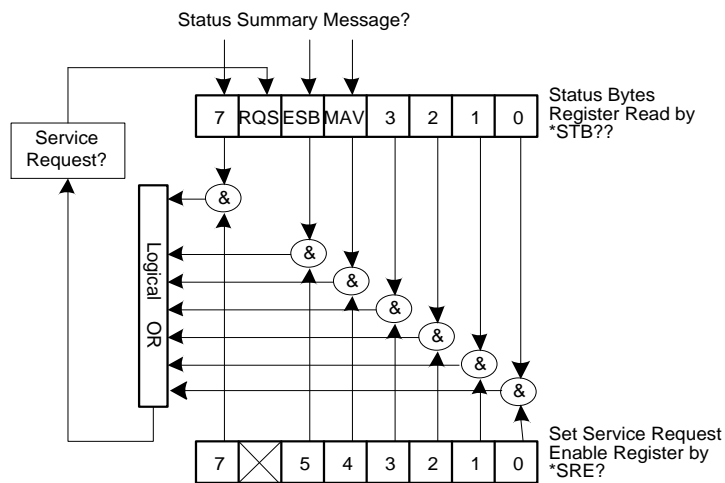

Figure 4-1

Table 4-6

Bit No.	Bit Weight	Description
7	128	Operation Status Register Summary Bit
6	64	Request Service Bit. This bit is set when any enabled bit of the Status Byte Register has been set, which indicates it has at least one reason for requesting service.
5	32	Standard Event Status Register Summary Bit.

4	16	Message Available Bit. This bit is set whenever there is data available in the output queue and is reset when the available data is read.
3-0		Always 0.

- Standard Event Status Register:
The Standard Event Status Register is frequently used. The common use commands *ESE and *ESR? can be utilized to program it.

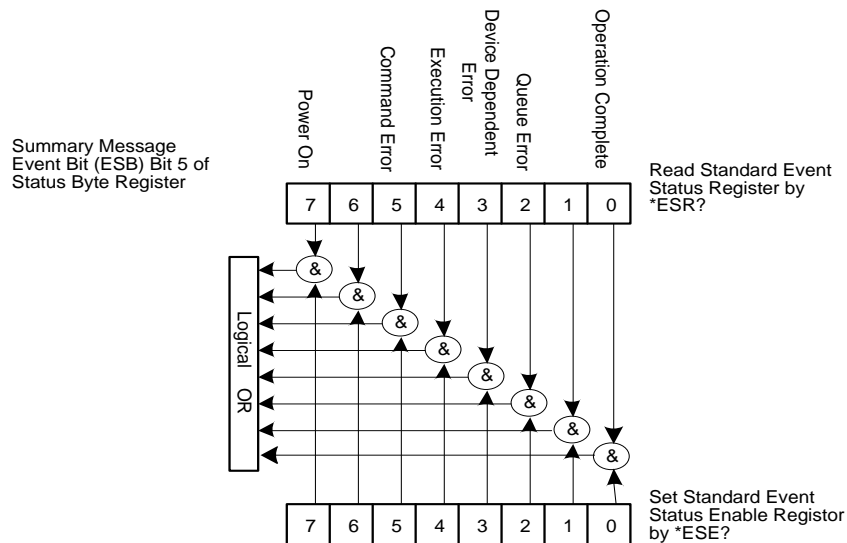

Figure 4-2

Table 4-7

Bit No.	Bit Weight	Description
7	128	Power on Bit. Reboot the electronic load can set this bit to 1.
6		Always 0.
5	32	Command Error Bit. This bit is set to 1 if there is any IEEE 488.2 syntax error.
4	16	Execution Error Bit. This bit is set to 1 when the command parameter is out of valid range or inconsistent.
3	8	Device Dependent Error Bit. This bit is set to 1 when too many errors have occurred and the error queue is full.
2	4	Queue Error Bit. This bit is set to 1 when reading data from the output buffer and no data is present, or when the data is lost.
1		Always 0.
0	1	

4.6.2 Specific Commands for 63700 Series

4.6.2.1 ABORT Subsystem

ABORt

Description: Sets all output states to "OFF".
 Syntax: ABORt

4.6.2.2 CONFIGURE Subsystem

1. CONFigure:BRIGhtness

Description: Sets the display brightness of the panel.
 Syntax: CONFigure:BRIGhtness< space >< CRD >
 Parameter: < CRD >: HIGH | NOR | DIM
 Example: CONFigure:BRIGhtness HIGH
 Query Syntax: CONFigure:BRIGhtness?
 Return Parameter: < CRD >: HIGH | NOR | DIM
 Query Example: CONFigure:BRIGhtness?
 Return Example: HIGH

2. CONFigure:BEEPer

Description: Sets the beeper to ON or OFF.
 Syntax: CONFigure:BEEPer< space >< CRD >
 Parameter: < CRD >: ON | OFF
 Example: CONF:BEEPer ON
 Query Syntax: CONFigure:BEEPer?
 Return Parameter: < CRD >: ON | OFF
 Query Example: CONFigure:BEEPer?
 Return Example: ON

3. CONFigure:OCP

Description: Sets to enable or disable the user-defined OCP function.
 Syntax: CONFigure:OCP< space >< CRD >
 Parameter: < CRD >: ENABLE | DISABLE
 Example: CONF:OCP ENABLE
 Query Syntax: CONFigure:OCP?
 Return Parameter: < CRD >: ENABLE | DISABLE
 Query Example: CONFigure:OCP?
 Return Example: ENABLE

4. CONFigure:OCP:POINt

Description: Sets the current limit for the user-defined OCP function.
 Syntax: CONFigure:OCP:POINt< space >< NRf+ >[suffix]
 Parameter: < NRf+ >: Refer to individual spec for valid numeric range.
 Example: CONF:OCP:POIN 3 It sets the current limit to 3A.
 CONF:OCP:POIN MAX It sets the maximum current limit.
 CONF:OCP:POIN MIN It sets the minimum current limit.
 Query Syntax: CONFigure:OCP:POINt?< space >[{MAX | MIN}]
 Return Parameter: < NRf+ >,[unit = Ampere]
 Query Example: CONF:OCP:POIN?
 CONF:OCP:POIN? MAX
 CONF:OCP:POIN? MIN

Return Example: 4.400000e+01

5. **CONFigure:OCP:DELay**

Description: Sets the delay time for the user-defined OCP function.
 Syntax: CONFigure:OCP:DELay< space >< NRf+ >[suffix]
 Parameter: < NRf+ >: Refer to individual spec for valid numeric range.
 Example: CONF:OCP:DEL 0.02 It sets the delay time to 20ms.
 CONF:OCP:DEL 20ms It sets the delay time to 20ms.
 CONF:OCP: DEL MAX It sets the maximum delay time.
 CONF:OCP: DEL MIN It sets the minimum delay time.
 Query Syntax: CONFigure:OCP:DELay? < space >[MAX | MIN]
 Return Parameter: < NRf+ >,[unit = Second]
 Query Example: CONF:OCP:DELay?
 CONF:OCP:DELay? MAX
 CONF:OCP:DELay? MIN
 Return Example: 1.000000e-02

6. **CONFigure:OPP**

Description: Sets to enable or disable the user-defined OPP function.
 Syntax: CONFigure:OPP< space >< CRD >
 Parameter: < CRD >: ENABLE | DISABLE
 Example: CONF:OPP ENABLE
 Query Syntax: CONFigure:OPP?
 Return Parameter: < CRD >: ENABLE | DISABLE
 Query Example: CONFigure:OPP?
 Return Example: ENABLE

7. **CONFigure:OPP:POINt**

Description: Sets the power limit for the user-defined OPP function.
 Syntax: CONFigure:OPP:POINt< space >< NRf+ >[suffix]
 Parameter: < NRf+ >: Refer to individual spec for valid numeric range.
 Example: CONF:OPP:POIN 300 It sets the power limit to 300W.
 CONF:OPP:POIN MAX It sets the maximum power limit.
 CONF:OPP:POIN MIN It sets the minimum power limit.
 Query Syntax: CONFigure:OPP:POINt?< space > [MAX | MIN]
 Return Parameter: < NRf+ >,[unit = Watt]
 Query Example: CONF:OPP:POIN?
 CONF:OPP:POIN? MAX
 CONF:OPP:POIN? MIN
 Return Example: 6.300000e+03

8. **CONFigure:OPP:DELay**

Description: Sets the delay time for the user-defined OPP function.
 Syntax: CONFigure:OPP:DELay< space >< NRf+ >[suffix]
 Parameter: < NRf+ >: Refer to individual spec for valid numeric range.
 Example: CONF:OPP:DEL 0.02 It sets the delay time to 20ms.
 CONF:OPP:DEL 20ms It sets the delay time to 20ms.
 CONF:OPP:DEL MAX It sets the maximum delay time.
 CONF:OPP:DEL MIN It sets the minimum delay time.
 Query Syntax: CONFigure:OPP:DELay?< space >[MAX | MIN]
 Return Parameter: < NRf+ >,[unit = Second]
 Query Example: CONF:OPP:DELay?
 CONF:OPP:DELay? MAX
 CONF:OPP:DELay? MIN

Return Example: 1.000000e-02

9. **CONFigure:VOLTage:ON**

Description: Sets the loading on voltage.
 Syntax: CONFigure:VOLTage:ON< space >< NRf+ >[suffix]
 Parameter: < NRf+ >: Refer to individual spec for valid numeric range.
 Example: CONF:VOLT:ON 0.5 It sets Von to 0.5V.
 CONF:VOLT:ON 500mV It sets Von to 0.5V.
 CONF:VOLT:On MAX It sets Von to the maximum.
 CONF:VOLT:ON MIN It sets Von to the minimum.
 Query Syntax: CONFigure:VOLTage:ON?< space >[{MAX | MIN}]
 Return Parameter: < NRf+ >,[unit = Voltage]
 Query Example: CONF:VOLT:ON?
 CONF:VOLT:ON? MAX
 CONF:VOLT:ON? MIN
 Return Example: 5.000000e-01

10. **CONFigure:VOLTage:OFF**

Description: Sets the loading off voltage.
 Syntax: CONFigure:VOLTage:OFF< space >< NRf+ >[suffix]
 Parameter: < NRf+ >: Refer to individual spec for valid numeric range.
 Example: CONF:VOLT:OFF 0.5 It sets Voff to 0.5V.
 CONF:VOLT:OFF 500mV It sets Voff to 0.5V.
 CONF:VOLT:OFF MAX It sets Voff to the maximum.
 CONF:VOLT:OFF MIN It sets Voff to the minimum.
 Query Syntax: CONFigure:VOLTage:OFF?< space >[{MAX | MIN}]
 Return Parameter: < NRf+ >,[unit = Voltage]
 Query Example: CONF:VOLT:OFF?
 CONF:VOLT:OFF? MAX
 CONF:VOLT:OFF? MIN
 Return Example: 5.000000e-01

11. **CONFigure:VOLTage:LATCh**

Description: Sets the Von Latch function.
 Syntax: CONFigure:VOLTage:LATCh< space >< CRD >
 Parameter: < CRD >: ON | OFF
 Example: CONF:VOLT:LATC ON
 Query Syntax: CONFigure:VOLTage:LATCh?
 Return Parameter: < CRD >: ON | OFF
 Query Example: CONF:VOLT:LATC?
 Return Example: ON

12. **CONFigure:VOLTage:LATCh:RESet**

Description: When Von Latch is enabled, reset the Von status.
 Syntax: CONFigure:VOLTage:LATCh:RESet
 Parameter: None.

13. **CONFigure:AUTO:ON**

Description: Sets Load ON automatically when powered on.
 Syntax: CONFigure:AUTO:ON< space >< CRD >
 Parameter: < CRD >: ON | OFF
 Example: CONF:AUTO:ON ON
 Query Syntax: CONFigure:AUTO:ON?
 Return Parameter: < CRD >: ON | OFF

Query Example: CONF: AUTO: ON?
Return Example: ON

14. CONFigure:AVG:TIMES

Description: Sets the average times for measuring input voltage/current.
Syntax: CONFigure:AVG:TIMES< space ><NR1>
Parameter: 0: 1 time
1: 2 times
2: 4 times
3: 8 times
4: 16 times
5: 32 times
Example: CONF:AVG:TIMES 0
Query Syntax: CONFigure:AVG:TIMES?
Return Parameter: 0~5
0: 1 time
1: 2 times
2: 4 times
3: 8 times
4: 16 times
5: 32 times
Query Example: CONF:AVG:TIMES?
Return Example: 0

15. CONFigure:AVG:METHod

Description: Sets the average method for measuring input voltage/current.
Syntax: CONFigure:AVG:METHod< space >< CRD >
Parameter: < CRD >: FIX | MOV
Example: CONF:AVG:METH FIX
Query Syntax: CONFigure:AVG:METHod?
Return Parameter: < CRD >:FIX | MOV
Query Example: CONF:AVG:METH?
Return Example: FIX

16. CONFigure:VOLTage:SIGN

Description: Sets the voltage sign for measurement.
Syntax: CONFigure:VOLTage:SIGN< space >< CRD >
Parameter: < CRD >: PLUS | MINUS
Example: CONF:VOLT:SIGN PLUS
Query Syntax: CONFigure:AUTO:ON?
Return Parameter: < CRD >: PLUS | MINUS
Query Example: CONF: VOLT:SIGN?
Return Example: PLUS

17. CONFigure:MSTSLV:ID

Description: Sets the device to Master. This command is not required for the Slave device.
Syntax: CONFigure:MSTSLV:ID< space >< CRD >
Parameter: < CRD >: MASTER
Example: CONF:MSTSLV:ID MASTER
Query Syntax: CONFigure:MSTSLV:ID?
Return Parameter: < CRD >: MASTER | SLAVE1 | SLAVE2 |
Query Example: CONF:MSTSLV:ID?
Return Example: MASTER

Note : CONFigure:MSTSLV? must be OFF when setting it. (Not in series/parallel mode.)

18. CONFigure:MSTSLV:PARSER

Description: Sets to series or parallel mode. Both Master and Slave need to be set by this command.
Syntax: CONFigure:MSTSLV:PARSER< space >< CRD >
Parameter: < CRD >: PARALLEL | SERIES
Example: CONF:MSTSLV:PARSER PARALLEL
Query Syntax: CONFigure:MSTSLV:PARSER?
Return Parameter: < CRD >:PARALLEL | SERIES
Query Example: CONF:MSTSLV:PARSER?
Return Example: PARALLEL

Note : 1. CONFigure:MSTSLV? must be OFF when setting it. (Not in series/parallel mode.)
2. The command for series connection is not supported at present.

19. CONFigure:MSTSLV:NUMSLV

Description: Sets the number of SLAVE to be controlled. This command is not required for the Slave device.
Syntax: CONFigure:MSTSLV:NUMSLV< space >< NR1 >
Parameter: < NR1 >
Example: CONF:MSTSLV:NUMSLV 1
Query Syntax: CONFigure:MSTSLV:NUMSLV?
Return Parameter: < NR1 >
Query Example: CONF:MSTSLV:NUMSLV?
Return Example: 1

Note : 1. CONFigure:MSTSLV? must be OFF when setting it. (Not in series/parallel mode.)
2. The series mode is not valid at present and only 2 slaves can be set when in parallel mode.

20. CONFigure:MSTSLV:READY?

Description: Queries the Master/Slave connection status.
Query Syntax: CONFigure:MSTSLV:READY?
Return Parameter: < CRD > ON | OFF | WAIT
Query Example: CONFigure:MSTSLV:READY?
Return Example: ON

21. CONFigure:MSTSLV

Description: Executes the Master/Slave control.
Syntax: CONFigure:MSTSLV< space >< CRD >
Parameter: < CRD >: ON | OFF
Example: CONF:MSTSLV ON
Query Syntax: CONFigure:MSTSLV?
Return Parameter: < CRD >:ON | OFF
Query Example: CONF:MSTSLV?
Return Example: ON

Note : Set the following 3 commands before controlling this function:
➤ CONFigure:MSTSLV:ID
➤ ONFigure:MSTSLV:PARSER
➤ CONFigure:MSTSLV:NUMSLV

- ⋮ Use CONFigure:MSTSLV:READY? to query the connection status at present. If the status is WAIT, query again until the status is ON | OFF to perform this function.

22. CONFigure:RECYcle:DISPlay

Description: Switches the display type of the energy recycling panel.
 Syntax: CONFigure:RECYcle:DISPlay< space >< CRD >
 Parameter: < CRD >: TOTAL | INTERVAL
 Example: CONF:RECY:DISP TOTAL
 Query Syntax: CONFigure:RECYcle:DISPlay?
 Return Parameter: < CRD >: TOTAL | INTERVAL
 Query Example: CONF:RECY:DISP?
 Return Example: TOTAL

23. CONFigure:RECYcle:INTerval:RESet

Description: Resets the interval record of recycled energy.
 Syntax: CONFigure:RECYcle:INTerval:RESet
 Parameter: None
 Example: CONF:RECY:INT:RES

24. CONFigure:RECYcle:INTerval

Description: Returns the interval record of recycled energy.
 Query Syntax: CONFigure:RECYcle:INTerval?
 Return Parameter: < NRf+ >,[unit = Watt]
 Example: CONF:RECY:INT?

25. CONFigure:RECYcle:TOTal

Description: Returns the total recycled energy.
 Query Syntax: CONFigure:RECYcle:TOTal?
 Return Parameter: < NRf+ >,[unit = Watt]
 Example: CONF:RECY:TOT?

4.6.2.3 MODE Subsystem

1. MODE

Description: Sets the operating mode of the electronic load.
 Syntax: MODE<space>< CRD >
 Parameter: < CRD > CC,CR,CV,CP,CCD
 Example: MODE CC
 Query Syntax: MODE?
 Return Parameter: < CRD >: CC,CR,CV,CP,CCD
 Query Example: MODE?
 Return Example: CC

4.6.2.4 LOAD Subsystem

1. LOAD[:STATe]

Description: Enables/turns on or disables/turns off the electronic load.
 Syntax: LOAD[:STATe]<space>< CRD >
 Parameter: < CRD >: ON | OFF
 Example: LOAD ON
 Query Syntax: LOAD[:STATe]?

Return Parameter: < CRD >:ON | OFF
 Query Example: LOAD?
 Return Example: ON

2. LOAD:PROTection?

Description: Returns the protection status of the electronic load.
 Query Syntax: LOAD:PROT?
 Return Parameter: <NR1> Return warning message 0~4294967295, 0: No warning, use binary for the rest, and identify the cause of the error.

BIT 0	OVP	BIT 16	Security IC Error
BIT 1	OCP1	BIT 17	Machine ID Error
BIT 2	OCP2	BIT 18	System parameter Error
BIT 3	OPP1	BIT 19	Boot Up Initial Error
BIT 4	OPP2	BIT 20	FAN Lock
BIT 5	OTP	BIT 21	FAN Start Up Error
BIT 6	UTP	BIT 22	Cascade Conn Error
BIT 7	Remote Inhibit	BIT 23	Slave Protect Alarm
BIT 8	InterLock	BIT 24	Save File Error
BIT 9	AD Number Error	BIT 25	In Boot Mode
BIT 10	DD Number Error	BIT 26	REV
BIT 11	CD FPGA Number Error	BIT 27	Reserve
BIT 12	AD_PROTECT	BIT 28	Reserve
BIT 13	DD_PROTECT	BIT 29	Reserve
BIT 14	FPGA Fail	BIT 30	Reserve
BIT 15	Calibration Error	BIT 31	Reserve

Query Example: LOAD?
 Return Example: 0

3. LOAD:PROTection:CLEAr

Description: Resets the electronic load status.
 Syntax: LOAD:PROTection:CLEAr
 Parameter: None
 Example: LOAD:PROT:CLE

4.6.2.5 CURRENT Subsystem

1. CURRent[:STATic]

Description: Sets the static load current in constant current static mode.
 Syntax: CURRent[:STATic]< space >< NRf+ >[suffix]
 Parameter: Refer to individual spec for valid numeric range.
 Example: CURR 20 It sets the static load current to 20A.
 CURR 10A It sets the static load current to 10A.
 CURR MAX It sets the maximum current for static load.
 CURR MIN It sets the minimum current for static load.
 Query Syntax: CURRent[:STATic]?[< space >< MAX | MIN >]
 Return Parameter: <NRf+> [unit = Ampere]
 Query Example: CURR?
 CURR? MAX
 CURR? MIN

Return Example: 2.000000e+01

2. CURRent[:STAtic]:SLEW

Description: Sets the current slew rate in constant current static mode.
 Syntax: CURRent[:STAtic]:SLEW< space >< NRf+ >[suffix]
 Parameter: Refer to individual spec for valid numeric range.
 Example: CURR:SLEW 2.5 It sets the current slew rate to 2.5A/ms.
 CURR:SLEW 1A/ms It sets the current slew rate to 2.5A/ms. 1A/ms.
 CURR:SLEW MAX It sets the maximum current slew rate.
 CURR:SLEW MIN It sets the minimum current slew rate.
 Query Syntax: CURRent[:STAtic]:SLEW? [< space >< MAX | MIN >]
 Return Parameter: <NRf+> [unit = A/ms]
 Query Example: CURR:SLEW?
 CURR:SLEW? MAX
 CURR:SLEW? MIN
 Return Example: 2.000000e+01

3. CURRent:DYNamic:L1

Description: Sets the load current during the T1 period in constant current dynamic mode.
 Syntax: CURRent:DYNamic:L1< space >< NRf+ >[suffix]
 Parameter: Refer to individual spec for valid numeric range.
 Example: CURR:DYN:L1 20 It sets the dynamic load L1 to 20A.
 CURR:DYN:L1 10A It sets the dynamic load L1 to 10A.
 CURR:DYN:L1 MAX It sets the dynamic load L1 to its maximum.
 CURR:DYN:L1 MIN It sets the dynamic load L1 to its minimum.
 Query Syntax: CURRent:DYNamic:L1? [< space >< MAX | MIN >]
 Return Parameter: <NRf+> [unit = Ampere]
 Query Example: CURR:DYN:L1?
 CURR:DYN:L1? MAX
 CURR:DYN:L1? MIN
 Return Example: 2.000000e+01

4. CURRent:DYNamic:L2

Description: Sets the load current during the T2 period in constant current dynamic mode.
 Syntax: CURRent:DYNamic:L2< space >< NRf+ >[suffix]
 Parameter: Refer to individual spec for valid numeric range.
 Example: CURR:DYN:L2 20 It sets the dynamic load L2 to 20A.
 CURR:DYN:L2 10A It sets the dynamic load L2 to 10A.
 CURR:DYN:L2 MAX It sets the dynamic load L2 to its maximum.
 CURR:DYN:L2 MIN It sets the dynamic load L1 to its minimum.
 Query Syntax: CURRent:DYNamic:L2? [< space >< MAX | MIN >]
 Return Parameter: <NRf+> [unit = Ampere]
 Query Example: CURR:DYN:L2?
 CURR:DYN:L2? MAX

Return Example: CURRE:DYN:L2? MIN
2.000000e+01

5. CURREnt:DYNamic:T1

Description: Sets the T1 execution period in constant current dynamic mode.
 Syntax: CURREnt:DYNamic:T1< space >< NRf+ >[suffix]
 Parameter: Refer to individual spec for valid numeric range.
 Example: CURRE:DYN:T1 10 It sets the dynamic load current T1 to 10s.
 CURRE:DYN:T1 10ms It sets the dynamic load current T1 to 10ms.
 CURRE:DYN:T1 MAX It sets the dynamic load current T1 to its maximum.
 CURRE:DYN:T1 MIN It sets the dynamic load current T1 to its minimum.
 Query Syntax: CURREnt:DYNamic:T1?[< space >< MAX | MIN >]
 Return Parameter: <NRf+> [unit = Second]
 Query Example: CURRE:DYN:T1?
 CURRE:DYN:T1? MAX
 CURRE:DYN:T1? MIN
 Return Example: 1.000000e+01

6. CURREnt:DYNamic:T2

Description: Sets the T2 execution period in constant current dynamic mode.
 Syntax: CURREnt:DYNamic:T2< space >< NRf+ >[suffix]
 Parameter: Refer to individual spec for valid numeric range.
 Example: CURRE:DYN:T2 10 It sets the dynamic load current T2 to 10s.
 CURRE:DYN:T2 10ms It sets the dynamic load current T2 to 10ms.
 CURRE:DYN:T2 MAX It sets the dynamic load current T2 to its maximum.
 CURRE:DYN:T2 MIN It sets the dynamic load current T2 to its minimum.
 Query Syntax: CURREnt:DYNamic:T2?[< space >< MAX | MIN >]
 Return Parameter: <NRf+> [unit= Second]
 Query Example: CURRE:DYN:T2?
 CURRE:DYN:T2? MAX
 CURRE:DYN:T2? MIN
 Return Example: 1.000000e+01

7. CURREnt:DYNamic:SLEW

Description: Sets the current slew rate in constant current dynamic mode.
 Syntax: CURREnt:DYNamic:SLEW< space >< NRf+ >[suffix]
 Parameter: Refer to individual spec for valid numeric range.
 Example: CURRE:DYN:SLEW 2.5 It sets the current slew rate to 2.5A/ms
 CURRE:DYN:SLEW 10A/ms It sets the current slew rate to 10A/ms.
 CURRE:DYN:SLEW MAX It sets the current slew rate to its maximum.
 CURRE:DYN:SLEW MIN It sets the current slew rate to its minimum.
 Query Syntax: CURREnt: DYNamic:SLEW?[< space >< MAX | MIN >]

Return Parameter: <NRf+> [unit= A/ms]
 Query Example: CURR:DYN:SLEW?
 CURR:DYN:SLEW? MAX
 CURR:DYN:SLEW? MIN
 Return Example: 1.000000e+01

8. CURRent:DYNamic:REPeat

Description: Sets the repeat count in constant current dynamic mode.
 Syntax: CURRent:DYNamic:REPeat< space >< NRf+ >
 Parameter: < NRf+ > 0~65535, resolution = 1, unit = None
 Example: CURR:DYN:REP 500 It sets the repeat count to 500.
 CURR:DYN:REP MAX It sets the repeat count to its maximum.
 CURR:DYN:REP MIN It sets the repeat count to its minimum.
 Query Syntax: CURRent: DYNamic:REPeat? [< space >< MAX | MIN >]
 Return Parameter: <NRf+> [unit= None]
 Query Example: CURR:DYN:REP?
 CURR:DYN:REP? MAX
 CURR:DYN:REP? MIN
 Return Example: 5.000000e+02

Note : Setting parameter 0 means unlimited times.

4.6.2.6 RESISTANCE Subsystem

1. RESistance[:STATic]

Description: Sets the static resistance level in constant resistance mode.
 Syntax: RESistance[:STATic]< space >< NRf+ >[suffix]
 Parameter: Refer to individual spec for valid numeric range.
 Example: RES 20 It sets the constant resistance to 20Ω.
 RES 10 OHM It sets the constant resistance to 10Ω.
 RES MAX It sets the constant resistance to its maximum.
 RES MIN It sets the constant resistance to its minimum.
 Query Syntax: RESistance[:STATic]? [< space >< MAX | MIN >]
 Return Parameter: <NRf+> [unit = Ohm]
 Query Example: RES?
 RES? MAX
 RES? MIN
 Return Example: 2.000000e+01

2. RESistance[:STATic]:SLEW

Description: Sets the current slew rate in constant resistance static mode.
 Syntax: RESistance[:STATic]:SLEW< space >< NRf+ >[suffix]
 Parameter: Refer to individual spec for valid numeric range.
 Example: RES:SLEW 2.5 It sets the current slew rate to 2.5A/ms.

	RES:SLEW 10A/ms	It sets the current slew rate to 10A/ms.
	RES:SLEW MAX	It sets the current slew rate to its maximum.
	RES:SLEW MIN	It sets the current slew rate to its minimum.
Query Syntax:	RESistance[:STATic]:SLEW? [< space >< MAX MIN >]	
Return Parameter:	<NRf+> [unit = A/ms]	
Query Example:	RES:SLEW? RES:SLEW? MAX RES:SLEW? MIN	
Return Example:	1.000000e+01	

4.6.2.7 VOLTAGE Subsystem

1. VOLTage[:STATic]

Description:	Sets the static load voltage in constant voltage mode	
Syntax:	VOLTage[:STATic]< space >< NRf+ >[suffix]	
Parameter:	Refer to individual spec for valid numeric range.	
Example:	VOLT 8	It sets the load constant voltage to 8V.
	VOLT 24V	It sets the load constant voltage to 24V.
	VOLT MAX	It sets the load constant voltage to its maximum.
	VOLT MIN	It sets the load constant voltage to its minimum.
Query Syntax:	VOLTage [:STATic]? [< space >< MAX MIN >]	
Return Parameter:	< NRf+ > [unit = Volt]	
Query Example:	VOLT? VOLT? MAX VOLT? MIN	
Return Example:	2.400000e+01	

2. VOLTage[:STATic]:ILIMit

Description:	Sets the current limit in constant voltage mode.	
Syntax:	VOLTage[:STATic]:ILIMit< space >< NRf+ >[suffix]	
Parameter:	Refer to individual spec for valid numeric range.	
Example:	VOLT:ILIM 3	It sets the load limit current to 3A.
	VOLT:ILIM MAX	It sets the load limit current to its maximum.
	VOLT:ILIM MIN	It sets the load limit current to its minimum.
Query Syntax:	VOLTage [:STATic]:ILIMit? [< space >< MAX MIN >]	
Return Parameter:	< NRf+ > [unit= Ampere]	
Query Example:	VOLT:ILIM? VOLT:ILIM? MAX VOLT:ILIM? MIN	
Return Example:	2.400000e+01	

3. VOLTage[:STATic]:RESponse

Description: Sets the response speed in constant voltage mode.
 Syntax: VOLTage [:STATic]:RESponse< space >< CRD >
 Parameter: < CRD >: SLOW | FAST
 Example: VOLT:RES FAST
 Query Syntax: VOLTage [:STATic]:RESponse?
 Return Parameter: < CRD >: SLOW | FAST
 Query Example: VOLT:RES?
 Return Example: FAST

4.6.2.8 POWER Subsystem**1. POWER[:STATic]**

Description: Sets the static load power in constant power static mode.
 Syntax: POWER[:STATic]< space >< NRf+ >[suffix]
 Parameter: Refer to individual spec for valid numeric range.
 Example: POW 20 It sets the static load power to 20W.
 POW 10W It sets the static load power to 10W.
 POW MAX It sets the static load power to its maximum.
 POW MIN It sets the static load power to its minimum.
 Query Syntax: POWER [:STATic]?[< space >< MAX | MIN >]
 Return Parameter: <NRf+> [unit = Watt]
 Query Example: POW?
 POW? MAX
 POW? MIN
 Return Example: 2.000000e+01

2. POWER [:STATic]:SLEW

Description: Sets the current slew rate in constant power static mode.
 Syntax: POWER [:STATic]:SLEW< space >< NRf+ >[suffix]
 Parameter: Refer to individual spec for valid numeric range.
 Example: POW:SLEW 2.5 It sets the current slew rate to 2.5A/ms.
 POW:SLEW 1A/ms It sets the current slew rate to 1A/ms.
 POW:SLEW MAX It sets the current slew rate to its maximum.
 POW:SLEW MIN It sets the current slew rate to its minimum.
 Query Syntax: POWER [:STATic]:SLEW?[< space >< MAX | MIN >]
 Return Parameter: <NRf+> [unit = A/ms]
 Query Example: POW:SLEW?
 POW:SLEW? MAX
 POW:SLEW? MIN
 Return Example: 2.000000e+01

4.6.2.9 FETCH Subsystem

1. FETCH:VOLTage?

Description: Measures the output of electronic load and returns real-time voltage.

Query Syntax: FETCH:VOLTage?

Return Parameter: <NRf+> [unit = Volt]

Query Example: FETC:VOLT?

Return Example: 9.983100e+00

2. FETCH:CURRENT?

Description: Measures the output of electronic load and returns real-time current (with sign).

Query Syntax: FETCH:CURRENT?

Return Parameter: < NRf+ > [unit = Ampere]

Query Example: FETC:CURR?

Return Example: 2.000000e-04

3. FETCH:POWER?

Description: Measures the output of electronic load and returns real-time power (with sign).

Query Syntax: FETCH:POWER?

Return Parameter: < NRf+ > [unit = Watt]

Query Example: FETC:POW?

Return Example: 5.000000e+03

4. FETCH:STATUS?

Description: Returns the status code of the electronic load's state.

Query Syntax: FETCH:STATUS?

Return Parameter: < NR1 >

< NR1 > Return warning message 0~4294967295, 0: no warning, use binary for the rest, and identify the cause of the error.

BIT 0	OVP	BIT 16	Security IC Error
BIT 1	OCP1	BIT 17	Machine ID Error
BIT 2	OCP2	BIT 18	System parameter Error
BIT 3	OPP1	BIT 19	Boot Up Initial Error
BIT 4	OPP2	BIT 20	FAN Lock
BIT 5	OTP	BIT 21	FAN Start-Up Error
BIT 6	UTP	BIT 22	Cascade Conn Error
BIT 7	Remote Inhibit	BIT 23	Slave Protect Alarm
BIT 8	InterLock	BIT 24	Save File Error
BIT 9	AD Number Error	BIT 25	In Boot Mode
BIT 10	DD Number Error	BIT 26	REV
BIT 11	CD FPGA Number Error	BIT 27	Reserve
BIT 12	AD_PROTECT	BIT 28	Reserve
BIT 13	DD_PROTECT	BIT 29	Reserve
BIT 14	FPGA Fail	BIT 30	Reserve
BIT 15	Calibration Error	BIT 31	Reserve

Query Example: FETCH:STAT?

Return Example: 0

4.6.2.10 MEASURE Subsystem

1. MEASure:VOLTage?

Description: Returns the voltage measured at the output of the electronic load.
 Query Syntax: MEASure:VOLTage?
 Return Parameter: < NRf+ > [unit = Volt]
 Query Example: MEAS:VOLT?
 Return Example: 8.120000e+01

2. MEASure:CURREnt?

Description: Returns the current measured at the output of the electronic load.
 Query Syntax: MEASure:CURREnt?
 Return Parameter: < NRf+ > [unit = Ampere]
 Query Example: MEAS: CURR?
 Return Example: 3.150000e+01

3. MEASure:POWER?

Description: Returns the power measured at the output of the electronic load.
 Query Syntax: MEASure: POWER?
 Return Parameter: < NRf+ > [unit =Watt]
 Query Example: MEAS: POW?
 Return Example: 5.000000e+03

4.6.2.11 SYSTEM Subsystem

1. SYSTem:ERRor?

Description: Returns the error message and code of the electronic load.
 Query Syntax: SYSTem:ERRor?
 Return Parameter: < ACCRD >

Table 4-8

Code	Error Message	Code	Error Message
0	"No error"	-101	"Invalid character"
-102	"Syntax error"	-103	"Invalid separator"
-104	"Data type error"	-105	"GET not allowed"
-106	"Illegal parameter value"	-108	"Parameter not allowed"
-109	"Missing parameter"	-112	"Program mnemonic too long"
-113	"Undefined header"	-121	"Invalid character in number"
-123	"Numeric overflow"	-124	"Too many digits"
-131	"Invalid suffix"	-141	"Invalid character data"
-148	"Character data not allowed"	-151	"Invalid string data"
-158	"String data not allowed"	-202	"Setting conflict"
-203	"Data out of range"	-204	"Too much data"
-211	"Data stale"	-224	"Self-test failed"
-225	"Too many errors"	-226	"INTERRUPTED"
-227	"UNTERMINATED"	-228	"DEADLOCKED"

-229	"MEASURE ERROR"	-230	"Sequence overflow"
-231	"Sequence selected error"		

Query Example: SYST:ERR?
 Return Example: -203, "Data out of range"

2. SYSTem:VERsion:INTernal?

Description: Queries the Host version.
 Query Syntax: SYSTem:VERsion:INTernal?< space >[< Arg >]
 Query Parameter: Arg: Select subsystem: 1~2, 1: DSP-CPU1, 2: DSP-CPU2
 Query Example: SYST:VERS:INT?
 Return Example: MAIN:0.70,PLD:0.27,PCB:01,UI:0.57

3. SYSTem:MODule:VERsion?

Description: Queries the module version.
 Query Syntax: SYSTem:MODule:VERsion? < space >< Arg1 >[<,>< Arg2 >]
 Query Parameter: Arg1: module no.: 1~3
 Arg2: module type: 1~2, 1: AD, 2: DD
 Query Example: SYST:MOD:VERS? 1,2
 Return Example: MAIN:0.90,BOOT:0_06,PLD:0.31,PCB:03

4. SYSTem:DATE

Description: Sets the system date.
 Syntax: SYSTem:DATE< space >< Arg1 ><,>< Arg2 ><,>< Arg3 >
 Parameter: Arg1: Year (NR1)
 Arg2: Month (NR1)
 Arg3: Day (NR1)
 Example: SYSTem:DATE 2020,01,01
 Query Syntax: SYSTem:DATE?
 Return Parameter: < Arg1 >,< Arg2 >,< Arg3 > same as the parameter.
 Query Example: SYST:DATE?
 Return Example: 2020,01,01

5. SYSTem:TIME

Description: Sets the system time.
 Syntax: SYSTem:TIME< space >< Arg1 ><,>< Arg2 ><,>< Arg3 >
 Parameter: < Arg1 >: Hour (NR1)
 < Arg2 >: Minute (NR1)
 < Arg3 >: Second (NR1)
 Example: SYSTem:TIME 20,30,01
 Query Syntax: SYSTem:TIME?
 Return Parameter: < Arg1 >,< Arg2 >,< Arg3 > same as the parameter.
 Query Example: SYST:TIME?
 Return Example: 20,30,01

6. SYSTem:COMMunicate:CAN:CYClic:TIME

Description: Sets the CAN cycle time
 Syntax: SYSTem:COMMunicate:CAN:CYClic:TIME< space >< NRf+ >
 Parameter: <NRf+> 0.001 to 3600
 Example: SYST:COMM:CAN:CYC:TIME 1.001
 Query Syntax: SYSTem:COMMunicate:CAN:CYClic:TIME?
 Return Parameter: <NRf+> [unit = Second]
 Query Example: SYST:COMM:CAN:CYC:TIME?

Return Example: 1.001000e+00

7. **SYSTem:COMMunicate:CAN:BAUD**

Description: Sets the CAN baud rate.

Syntax: SYSTem:COMMunicate:CAN:BAUD< space ><NR1>

Parameter:

Parameter	Baudrate	Parameter	Baudrate
0	10k	7	200k
1	20k	8	250k
2	40k	9	400k
3	50k	10	500k
4	80k	11	800k
5	100k	12	1000k
6	125k		

Example: SYST:COMM:CAN:BAUD 12

Query Syntax: SYSTem:COMMunicate:CAN:BAUD?

Return Parameter: <NR1>

Query Example: SYST:COMM:CAN:BAUD?

Return Example: 12

8. **SYSTem:COMMunicate:CAN:ID**

Description: Sets the CAN ID.

Syntax: SYSTem:COMMunicate:CAN:ID< space ><NR1>

Parameter: <NR1> 11bit: 0 to 2047, 29bit: 0 to 536870911

Example: SYST:COMM:CAN:ID 1024

Query Syntax: SYSTem:COMMunicate:CAN:ID?

Return Parameter: <NR1>

Query Example: SYST:COMM:CAN:ID?

Return Example: 1024

9. **SYSTem:COMMunicate:CAN:MASK**

Description: Sets the CAN ID mask.

Syntax: SYSTem:COMMunicate:CAN:MASK< space ><NR1>

Parameter: <NR1> 11bit: 0 to 2047, 29bit: 0 to 536870911

Example: SYST:COMM:CAN:MASK 256

Query Syntax: SYSTem:COMMunicate:CAN:MASK?

Return Parameter: <NR1>

Query Example: SYST:COMM:CAN:MASK?

Return Example: 256

10. **SYSTem:COMMunicate:CAN:MODE**

Description: Sets the CAN 11 bit / 29 bit mode.

Syntax: SYSTem:COMMunicate:CAN:MODE< space ><NR1>

Parameter: <NR1> 0: 11bit, 1: 29bit

Example: SYST:COMM:CAN:MODE 1

Query Syntax: SYSTem:COMMunicate:CAN:MODE?

Return Parameter: <NR1>

Query Example: SYST:COMM:CAN:MODE?

Return Example: 1

11. **SYSTem:COMMunicate:CAN:PADding**

Description: Sets the CAN padding function.

Syntax: SYSTem:COMMunicate:CAN:PADding< space >< CRD >

Parameter: < CRD > ENABLE | DISABLE
Example: SYST:COMM:CAN:PAD ENABLE
Query Syntax: SYSTem:COMMunicate:CAN:PADding?
Return Parameter: < CRD > ENABLE | DISABLE
Query Example: SYST:COMM:CAN:MODE?
Return Example: ENABLE

12. **SYSTem:COMMunicate:CAN:APPLY**

Description: Updates the CAN setting.
Syntax: SYSTem:COMMunicate:CAN:APPLY
Parameter: None
Example: SYST:COMM:CAN:APPLY
Query Syntax: SYSTem:COMMunicate:CAN:APPLY?
Return Parameter: < CRD > DONE | UNDONE
Query Example: SYST:COMM:CAN:APPLY?
Return Example: DONE

13. **SYSTem:COMMunicate:GPIB:ADDRess**

Description: Sets the GPIB address.
Syntax: SYSTem:COMMunicate:GPIB:ADDRess< space ><NR1>
Parameter: <NR1> 1~30
Example: SYST:COMM:GPIB:ADDR 5
Query Syntax: SYSTem:COMMunicate:GPIB:ADDRess?
Return Parameter: <NR1>
Query Example: SYST:COMM:GPIB:ADDR?
Return Example: 5

14. **SYSTem:COMMunicate:SOCK:MODE**

Description: Sets the Ethernet Mode.
Syntax: SYSTem:COMMunicate:SOCK:MODE< space >< CRD >
Parameter: < CRD > MANUAL | AUTO
Example: SYST:COMM:SOCK:MODE MANUAL
Query Syntax: SYSTem:COMMunicate:SOCK:MODE?
Return Parameter: < CRD > MANUAL | AUTO
Query Example: SYST:COMM:SOCK:MODE?
Return Example: MANUAL

15. **SYSTem:COMMunicate:SOCK:GATEway**

Description: Sets the Ethernet Gateway.
Syntax: SYSTem:COMMunicate:SOCK:GATEway < space >< Arg >
Parameter: Refer to individual spec for valid numeric range.
Example: SYST:COMM:SOCK:GATE "255.255.255.0"
Query Syntax: SYSTem:COMMunicate:SOCK:GATEway?
Return Parameter: < Arg > "255.255.255.0"
Query Example: SYST:COMM:SOCK:GATE?
Return Example: "255.255.255.0"

16. **SYSTem:COMMunicate:SOCK:IP**

Description: Sets the Ethernet IP.
Syntax: SYSTem:COMMunicate:SOCK:IP< space >< Arg >
Parameter: Refer to individual spec for valid numeric range.
Example: SYST:COMM:SOCK:IP "192.168.1.10"
Query Syntax: SYSTem:COMMunicate:SOCK:IP?
Return Parameter: < Arg > "192.168.1.10"

Query Example: SYST:COMM:SOCK:IP?
Return Example: "192.168.1.10"

17. SYSTem:COMMunicate:SOCK:MASK

Description: Sets the Ethernet IP Mask.
Syntax: SYSTem:COMMunicate:SOCK:MASK< space >< Arg >
Parameter: Refer to individual spec for valid numeric range.
Example: SYST:COMM:SOCK:MASK "192.168.1.1"
Query Syntax: SYSTem:COMMunicate:SOCK:MASK?
Return Parameter: < Arg > "192.168.1.1"
Query Example: SYST:COMM:SOCK:MASK?
Return Example: "192.168.1.1"

18. SYSTem:COMMunicate:SOCK:APPLY

Description: Updates the Ethernet device. (Only valid when Ethernet is connected.)
Syntax: SYSTem:COMMunicate:SOCK:APPLY
Parameter: None
Example: SYST:COMM:SOCK:APPLY
Query Syntax: SYSTem:COMMunicate:SOCK:APPLY?
Return Parameter: < CRD > DONE | UNDONE
Query Example: SYST:COMM:SOCK:APPLY?
Return Example: DONE

4.6.2.12 INSTRUMENT Subsystem

1. INSTrument:STATus:AD?

Description: Returns the AD module status.
Query Syntax: INSTrument:STATus:AD?< space >< NR1 >
Query Parameter: < NR1 > 1 | 2 | 3
Return Parameter: 0 ~ 4294967295 ($2^{32}-1$)

BIT 0	AD_VDC_OVP	BIT 16	DD_IO_REG_OCP
BIT 1	AD_VDC_UVP	BIT 17	AD_RLY_STARTFAIL
BIT 2	AD_VRS_OVP	BIT 18	AD_PWM_TOP_FAULT
BIT 3	AD_VTR_OVP	BIT 19	AD_PWM_BOT_FAULT
BIT 4	AD_VST_OVP	BIT 20	AD_AC_STARTFAIL
BIT 5	AD_VRS_UVP	BIT 21	AD_PFC_STARTFAIL
BIT 6	AD_VTR_UVP	BIT 22	AD_HARD_ERR
BIT 7	AD_VST_UVP	BIT 23	DD_VO_UVP_S
BIT 8	DD_VO_OVP_F	BIT 24	AD_MODEL_RES_ERR
BIT 9	DD_VO_UVP_F	BIT 25	DD_SHORT
BIT 10	AD_IR_OCP	BIT 26	AD_MEM_ERR
BIT 11	AD_IT_OCP	BIT 27	DD_LLC_STARTFAIL
BIT 12	AD_IS_OCP	BIT 28	AD_VAC_UBL
BIT 13	AD_Vd_OVP	BIT 29	DD_IP_OCP
BIT 14	DD_IO_SRC_OCP	BIT 30	AD_Vd_UVP
BIT 15	AD_OTP	BIT 31	AD_FRE_ERR

Query Example: INST:STAT:AD? 1
Return Example: 4194304

2. INSTRument:STATus:DD?

Description: Returns the DD module status.
 Query Syntax: INSTRument:STATus:DD?<space>< NR1 >
 Query Parameter: < NR1 > 1 | 2 | 3
 Return Parameter: 0 ~ 4294967295 (2³²-1)

BIT 0	OVP	BIT 16	SRAM_ERR
BIT 1	SOC	BIT 17	Reserve
BIT 2	LOCP	BIT 18	Reserve
BIT 3	IL_SHARE	BIT 19	Reserve
BIT 4	SENSE_FAULT	BIT 20	Reserve
BIT 5	MODULE_ERR	BIT 21	Reserve
BIT 6	AD_ERR	BIT 22	Reserve
BIT 7	OTP	BIT 23	Reserve
BIT 8	HOST_SHUTDOWN	BIT 24	Reserve
BIT 9	UTP	BIT 25	Reserve
BIT 10	Reserve	BIT 26	CALIB_WARN
BIT 11	MOS_SHORT	BIT 27	PWM_CH1_WARN
BIT 12	HOST_SYNC	BIT 28	PWM_CH2_WARN
BIT 13	DB_FAULT	BIT 29	PWM_CH3_WARN
BIT 14	AUX_FAULT	BIT 30	CAN_ID_WARN
BIT 15	OPP	BIT 31	PCB_VER_WARN

Query Example: INSTR:STAT:DD? 1
 Return Example: 256

5. Self Test and Troubleshooting

5.1 Overview

Follow the actions described in this chapter to inspect the instrument and troubleshoot problems if the 63700 Series Regenerative DC Electronic Load is unable to operate normally. Please consult with Chroma or its sales agent if the information provided in this manual is unable to resolve the problem.

5.2 Troubleshooting

Operation problems and suggestions for resolution:

Problem	Cause	Resolution
Bad measurement for V, I	Feature swings due to aged components.	It needs calibration periodically. If calibration is required, please contact the Technical Service Center of Chroma.
Output is not within Accuracy SPEC.	Feature swings due to aged components.	It needs calibration periodically. If calibration is required, please contact the Technical Service Center of Chroma.
Over Temperature Protection (OTP)	1. The ambient temperature is too high. 2. The vent is blocked.	1. Operate the instrument within the temperature of 0 ~ 40°C. 2. Clear the vent.
Over Power Protection (OPP)	The output power exceeds the spec.	Remove the overload or enlarge the OPP settings.
Over Current Protection (OCP)	The output current exceeds the spec. or OCP settings.	Remove the overload or enlarge the OCP settings.
Fan Fail Protection (FAN LOCK)	1. The fan is out of order. 2. The feedback circuit is abnormal.	Consult with your local sales agent if it is unable to reset the protection state.
Input Error Protection 1 AC FAULT	The voltage of the AC input line is either too low or too high.	Adjust the voltage if it exceeds the spec. when measuring the input voltage.
No output voltage	1. The output voltage feedback is abnormal. 2. The D/D power stage is damaged.	Consult with your local sales agent if it is unable to reset the protection state.
Over Voltage Protection (OVP)	The output voltage exceeds the spec. or OVP settings.	1. Check the OVP settings. 2. Consult with your local sales agent if it is unable to reset the protection state.
Unable to control DC electronic load via GPIB	1. The address of the DC electronic load is incorrect. 2. The GPIB cable is loose and has fallen at the rear.	1. Update the address. 2. Check the cable connection and secure it with screws.
D/D power stage error protection (D/D FAULT)	1. The transient current is too big.	1. When D/D FAULT protection occurs, first turn off the

Problem	Cause	Resolution
	2. The D/D power stage is damaged.	electronic load and remove the load. Also, make sure the cables are connected correctly, and then power it on again. 2. Consult with your local sales agent for further assistance.
MATCH warning for incompatible models when connecting in series or parallel (ERROR!!! MASTER OR SLAVE NO MATCH)	The model numbers do not match.	1. The power supplies of different models are unable to be connected in series or parallel for use. 2. Consult with your local sales agent for further assistance.
FPGA UPDATE! version incompatible protection (FPGA IS TOO OLD, PLS UPDATE!)	The electronic load's FPGA does not match the F/W.	Consult with your local sales agent for further assistance.

Appendix A Analog Interface Pin Assignments

The 25-pin connector is located at the rear panel as Figure A-1 shows:

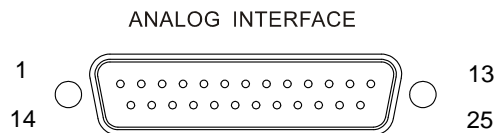

Figure A-0-1

Pin No.	Type	Pin Definition	Pin No.	Type	Pin Definition
1	N.C.	N.C.	14	OUT	FAULT
2	OUT	DC_ON_ST	15	N.C.	N.C.
3	IN	INTERLOCK	16	GND	DPG_GND
4	N.C.	N.C.	17	N.C.	N.C.
5	N.C.	N.C.	18	N.C.	N.C.
6	N.C.	N.C.	19	GND	DPG_GND
7	N.C.	N.C.	20	N.C.	N.C.
8	N.C.	N.C.	21	N.C.	N.C.
9	N.C.	N.C.	22	GND	APG_GND
10	OUT	AIO_MEAS_V	23	N.C.	N.C.
11	N.C.	N.C.	24	GND	APG_GND
12	OUT	AVO_MEAS_V	25	N.C.	N.C.
13	N.C.	N.C.			

- (1) PIN 1: N.C.
- (2) PIN 2: DC_ON_ST, DC ON output signal, Pull: High (positive edge trigger).
- (3) PIN 3: INTERLOCK, this function allows users to control the electronic load for temporary OFF. See section 3.2.2.3.3 for detailed info.
- (4) PIN 4: N.C.
- (5) PIN 5: N.C.
- (6) PIN 6: N.C.
- (7) PIN 7: N.C.
- (8) PIN 8: N.C.
- (9) PIN 9: N.C.
- (10) PIN 10: AIO_MEAS_V, current measurement only that allows you to set in "voltage form" with input voltage range from 0V to 10V.
- (11) PIN 11: N.C.
- (12) PIN 12: AVO_MEAS_V, voltage measurement only that allows you to set in "voltage form" with input voltage range from 0V to 10V.
- (13) PIN 13: N.C.
- (14) PIN 14: FAULT, the signals include output over voltage, output over current, output over power and FOLDBACK, over temperature, fan failure, and input over voltage or input under voltage protection; Pull: Low (negative edge trigger).
- (15) PIN 15: N.C.
- (16) PIN 16: DPG_GND, analog signal for grounding.
- (17) PIN 17: N.C.
- (18) PIN 18: N.C.

- (19) PIN 19: DPG_GND, analog signal for grounding.
- (20) PIN 20: N.C.
- (21) PIN 21: N.C.
- (22) PIN 22: APG_GND, analog signal for grounding.
- (23) PIN 23: N.C.
- (24) PIN 24: APG_GND, analog signal for grounding.
- (25) PIN 25: N.C.

Appendix B List of Protection

Follow the protections described in this appendix to inspect the instrument and troubleshoot any problems if the 63700 Regenerative DC Electronic Load is unable to operate normally. Please consult Chroma or the sales agent if the information provided in this manual is unable to resolve the problem.

The table below lists the system protection:

Message on Panel	Protection	Possible Cause	Troubleshooting
OVP1	It means the output voltage exceeds 1.1 times the model-rated voltage.	The input voltage is over $V_{max} \times 1.1$.	Check if the UUT output voltage exceeds the model-rated voltage.
OCP1	It means the loading current exceeds 1.1 times the model-rated current.	The loading current is over $I_{max} \times 1.1$.	Calculate the UUT voltage and the device setting, and if the loading current exceeds the model-rated current.
OCP2	It means the loading current exceeds the current set on the user protection interface.	The loading current is over the current set on the protection interface.	Check the loading setting of the device and the current setting on the protection interface.
OPP1	It means the loading power exceeds 1.05 times the model-rated power.	The loading power is over $P_{max} \times 1.05$.	Calculate the UUT voltage and the device setting, and if the loading power exceeds the model-rated power.
OPP2	It means the loading power exceeds the power set on the user protection interface.	The loading power is over the power set on the protection interface.	Check the loading setting of the device and the power setting on the protection interface.
UTP	It means the internal temperature of the whole device is too low.	<ol style="list-style-type: none"> The operating environment temperature is under the limit. The module component is abnormal. The circuit detection is malfunctioning. 	<ol style="list-style-type: none"> Eliminate the ambient under temperature problem. Contact Chroma's service center to fix it.
SYS_OTP	When the internal temperature IC of the electronic load is over 53°C , the output will be turned off.	<ol style="list-style-type: none"> The ambient temperature of the air inlet is over the 40°C specification. Dust accumulation on the front panel 	<ol style="list-style-type: none"> The ambient temperature of the air inlet should be immediately lowered to below the specification

Message on Panel	Protection	Possible Cause	Troubleshooting
		<p>filter causes the air intake to decrease resulting in the internal temperature rising.</p> <p>3. Some internal module components are overheated, triggering the panel to prompt a warning message.</p>	<p>of 40°C.</p> <p>2. Clean the dust on the front panel filter.</p>
NOTICE_OTP	When the internal temperature IC of the electronic is over 50°C, it will prompt a warning message.	<p>1. The ambient temperature of the air inlet is over the 40°C specification.</p> <p>2. Dust accumulation on the front panel filter causes the air intake to decrease resulting in the internal temperature rising.</p> <p>3. Some internal module components are overheated, triggering the panel to prompt a warning message.</p>	<p>1. The ambient temperature of the air inlet should be immediately lowered to below the specification of 40°C.</p> <p>2. Clean the dust on the front panel filter.</p>
FANLOCK	It means the detected fan speed is abnormal. (Latch)	<p>1. The fan is not connected.</p> <p>2. The fan power is abnormal or damaged.</p> <p>3. The fan is blocked by a foreign object.</p>	<p>1. Make sure the fan is correctly connected.</p> <p>2. Make sure the fan is normal and not damaged.</p> <p>3. Make sure there is no foreign object blocking the fan.</p>
CALIB_ERR	It means the device has no calibrated value or the calibration is an error.	The device has no calibrated value or the calibrated value is over the range.	Recalibrate the device.
INTERLOCK	It means the external ANALOG INPUT Inter Lock triggers full device protection.	ANALOG INPUT Interlock triggers the device protection.	Check if the external ANALOG INPUT Interlock triggers the device protection.
DFPGA_FAIL	It means the device power-on initialization	The control board component of the	Contact Chroma's service center to fix it.

Message on Panel	Protection	Possible Cause	Troubleshooting
	of communication is abnormal.	system device is abnormal.	
SECURE_IC_ERR	It means that an error occurred during security IC identification.	The internal components are abnormal.	Contact Chroma's service center to fix it.
MACHINE_ID_ERR	It means the identification of the model name (number of modules) is wrong.	<ol style="list-style-type: none"> 1. The firmware in the Security IC version is wrong. 2. The Security IC has fallen off. 3. The Security IC is damaged. 	Contact Chroma's service center to fix it.
IN_BOOT_MODE	It means the device initialization process is abnormal.	<ol style="list-style-type: none"> 1. The burned-in Security IC version is wrong. 2. The system control board is abnormal. 	Contact Chroma's service center to fix it.
AD_NUM_ERR	It means the AC/DC and DC/DC (front) modules cannot be identified.	<ol style="list-style-type: none"> 1. The comm. cable of the AC/DC and DC/DC (front) module control board has fallen off. 2. The control board of the AC/DC and DC/DC (front) modules is abnormal. 	Contact Chroma's service center to fix it.
DD_NUM_ERR	It means the DC/DC (rear) module cannot be recognized.	<ol style="list-style-type: none"> 1. The comm. cable of the DC/DC (rear) module control board has fallen off. 2. The control board DC/DC (rear) module is abnormal. 	Contact Chroma's service center to fix it.
CD_FPGA_NUM_ERR	It means the DC/DC (rear) module cannot be recognized.	<ol style="list-style-type: none"> 1. The comm. cable of the DC/DC (rear) module control board has fallen off. 2. The control board DC/DC (rear) module is abnormal. 	Contact Chroma's service center to fix it.
CASCADE_CONN_ERR	It means the connection of multiple devices failed due to	The comm. cable used for connecting multiple devices is	<ol style="list-style-type: none"> 1. Check if the comm. Cable is correctly connected or

Message on Panel	Protection	Possible Cause	Troubleshooting
	being unable to recognize.	wrong or has fallen off.	loose. 2. Check if the version of display port cable is 1.2 or above.
SLAVE_PROTECT_ERR	It means the connected multiple Slave devices are warning the Master.	A Slave warning status is applied to multiple devices.	Check the Slave warning status.
REV	It means the Input voltage is reversed.	The input voltage is connected in reverse.	Check if the UUT is connected correctly.
AD_SLEEP	AD failed to enter sleep mode.	AD failed to enter sleep mode.	Reboot the electronic load.
AD_WAKEUP	AD wakeup failed.	AD wakeup failed.	Reboot the electronic load.

The table below lists the protections of front stage module:

Message	Protection	Possible Cause	Troubleshooting
AD_OTP(*)	It occurs when the internal temperature of the AC/DC or DC/DC (front) power module is too high. (Latch)	1. The operating environment temperature is over. 2. The module power switch is abnormal. 3. The circuit detection is malfunctioning.	1. Eliminate the ambient overheating problem. 2. Contact Chroma's service center to fix it.
AD_VRS_OVP(*) AD_VTR_OVP(*) AD_VST_OVP(*)	It means the line transient input voltage of the AD/DC module is over the specification. (Latch)	1. The input power is abnormal. 2. The AC/DC module measurement circuit is abnormal.	3. Check if the input power meets the rated value. 4. Contact Chroma's service center to fix it.
AD_VRS_UVP(*) AD_VTR_UVP(*) AD_VST_UVP(*)	It means the line transient input voltage of the AD/DC module is under the specification. (Latch)	1. The input power is abnormal. 2. The AC/DC module input fuse is broken. 3. The AC/DC module measurement circuit is abnormal.	1. Check if the input power meets the rated value. 2. Contact Chroma's service center to fix it.
AD_VAC_UBL(*)	It means the line input of the AD/DC module is unbalanced or phase loss. (Latch)	1. The input power is connected wrong (the line voltage difference is 10%). 2. The input power	1. Check if the 3-phase input line voltage meets the rated value. 2. Contact Chroma's service center to

Message	Protection	Possible Cause	Troubleshooting
		<ul style="list-style-type: none"> is disconnected (phase loss). 3. The AC/DC module fuse is damaged. 4. The measurement circuit of the AC/DC module is abnormal. 	fix it.
AD_FRE_ERR(*)	It means the line input frequency of the AD/DC module is out of specification. (Latch)	The Mains frequency is abnormal.	Check if the mains frequency exceeds the range. (47Hz-63Hz)
AD_AC_STARTFAIL(*)	It means the AD/DC module has not reached the starting conditions and the DC BUS rectified voltage is out of specification. (Latch)	<ul style="list-style-type: none"> 1. The input power is connected wrong. 2. The input power is disconnected. 3. The AC/DC module fuse is damaged. 4. The measurement circuit of the AC/DC module is abnormal. 5. The drive signal of the AC/DC module relay is abnormal or the relay is damaged. 6. The PWM drive signal of the AC/DC module is abnormal. 7. The AC/DC power component is abnormal or damaged. 	<ul style="list-style-type: none"> 1. Check if the input power meets the rated value. 2. Contact Chroma's service center to fix it.
AD_PFC_STARTFAIL(*)	It means the start of the AD/DC module has failed and the DC BUS voltage is out of specification. (Latch)	<ul style="list-style-type: none"> 1. The measurement circuit of the AC/DC module is abnormal. 2. The drive signal of the AC/DC module relay is abnormal or the relay is damaged. 3. The PWM drive signal of the AC/DC module is 	<ul style="list-style-type: none"> 1. Check if the input power meets the rated value. 2. Contact Chroma's service center to fix it.

Message	Protection	Possible Cause	Troubleshooting
		<p>abnormal.</p> <p>4. The AC/DC power component is abnormal or damaged.</p>	
AD_MODEL_RES_ERR(*)	It means the output terminal of the AD/DC module cannot be identified as a Buck or Inverter module. (Latch)	<p>1. The GPIO pins are abnormal.</p> <p>2. The hardware resistor is dropped or printed wrong.</p>	Contact Chroma's service center to fix it.
AD_IR_OCP(*) AD_IT_OCP(*) AD_IS_OCP(*)	It means the transient input current of the AD/DC line is over the limit. (Latch)	<p>1. The output transient power is too high (input line current is higher than 14Arms, 18kW; 12Arms, 12kW)</p> <p>2. The measurement circuit of the AC/DC module is abnormal.</p>	<p>1. Remove the UUT and check if the operation is correct.</p> <p>2. Contact Chroma's service center to fix it.</p>
AD_VDC_OVP(*)	It means the DC BUS transient voltage of the AD/DC module is over the specification. (Latch)	<p>1. The output transient power is too high (the VDC is over 850V that has protection occurred.) (Regen Mode)</p> <p>2. The measurement circuit of the AC/DC module is abnormal.</p>	<p>1. Remove the UUT and check if the operation is correct.</p> <p>2. Contact Chroma's service center to fix it.</p>
AD_VDC_UVP(*)	It means the internal DC BUS transient voltage of the AD/DC module is under the specification. (Latch)	<p>1. The measurement circuit of the AC/DC module is abnormal.</p> <p>2. The drive signal of the AC/DC module relay is abnormal or the relay is damaged.</p> <p>3. The PWM drive signal of the AC/DC module is abnormal.</p>	<p>1. Remove the UUT and check if the operation is correct.</p> <p>2. Contact Chroma's service center to fix it.</p>
AD_Vd_UVP(*)	It means the input voltage amplitude of	1. The input power is abnormal.	1. Check if the input power meets the

Message	Protection	Possible Cause	Troubleshooting
	the AD/DC module is under the specification. (Latch)	2. The AC/DC module fuse is damaged. 3. The measurement circuit of the AC/DC module is abnormal.	rated value. 2. Contact Chroma's service center to fix it.
AD_Vd_OVP(*)	It means the input voltage amplitude of the AD/DC module is over the specification. (Latch)	1. The input power is abnormal. 2. The measurement circuit of the AC/DC module is abnormal.	1. Check if the input power meets the rated value. 2. Contact Chroma's service center to fix it.
AD_PWM_TOP_FAULT(*)	It means the internal power components of the AD/DC module are shorted. (Latch)	The top power component on the AC/DC module is abnormal or damaged.	1. Remove the UUT and check if the operation is correct. 2. Contact Chroma's service center to fix it.
AD_PWM_BOT_FAULT(*)	It means the internal power components of the AD/DC module are shorted. (Latch)	The bottom power component on the AC/DC module is abnormal or damaged.	1. Remove the UUT and check if the operation is correct. 2. Contact Chroma's service center to fix it.
AD_HARD_ERR(*)	The front stage module in the device has triggered protection. This message is used to stop the normal module from the output. (Latch)	1. One of the AC/DC modules in the device has protection occurred. 2. A certain AC/DC module message or measured value cannot be found in the device.	Contact Chroma's service center to fix it.
AD_MEM_ERR(*)	It means the DSP memory on the AC/DC module digital board is abnormal. (Latch)	The AC/DC module digital board DSP memory is abnormal.	Contact Chroma's service center to fix it.
DD_LLC_STARTFAIL(*)	It means the start of the DC/DC (front) module has failed, and the DC BUS voltage is out of specification. (Latch)	1. The measurement circuit of the DC/DC (front) module is abnormal. 2. The PWM drive signal of the DC/DC (front) module is abnormal. 3. The power components of the DC/DC (front)	1. Remove the UUT and check if the operation is correct. 2. Contact Chroma's service center to fix it.

Message	Protection	Possible Cause	Troubleshooting
		module are abnormal or damaged.	
DD_SHORT(*)	It means the primary side transient of the DC/DC module has an overcurrent. (Latch)	<ol style="list-style-type: none"> 1. The LC board is unlocked or not secured. 2. The output terminal of the DC/DC module is shorted. 3. The top and bottom leg of the secondary side switch on the DC/DC module are shorted. 	Contact Chroma's service center to fix it.
DD_IP_OCP(*)	It means the internal transient of the DC/DC (front) module has an overcurrent. (Latch)	<ol style="list-style-type: none"> 1. The output transient power is too high (the IO module is over 51A peak that has protection occurred.) (Source/Regen Mode) 2. The measurement circuit of the DC/DC (front) module is abnormal. 3. The PWM drive signal of the DC/DC (front) module is abnormal. 4. The power components of the DC/DC (front) module are abnormal or damaged. 	<ol style="list-style-type: none"> 1. Remove the UUT and check if the operation is correct. 2. Contact Chroma's service center to fix it.
DD_IO_SRC_OCP(*)	It means the internal transient of the DC/DC (front) module has an overcurrent. (Latch)	<ol style="list-style-type: none"> 1. The measurement circuit of the DC/DC (front) module is abnormal. 2. The power components of the DC/DC (front) module are abnormal or damaged. 	<ol style="list-style-type: none"> 1. Remove the UUT and check if the operation is correct. 2. Contact Chroma's service center to fix it.

Message	Protection	Possible Cause	Troubleshooting
DD_IO_REG_OCP(*)	It means the internal transient of the DC/DC (front) module has an overcurrent. (Latch)	<ol style="list-style-type: none"> 1. The output transient power is too high (the IO module is over 10Arms, 18kW; 7A, 12kW that has protection occurred.) 2. The measurement circuit of the DC/DC (front) module is abnormal. 3. The power components of the DC/DC (front) module are abnormal or damaged. 	<ol style="list-style-type: none"> 1. Remove the UUT and check if the operation is correct. 2. Contact Chroma's service center to fix it.
DD_VO_OVP_F(*)	It means the DC BUS transient voltage of the DC/DC (front) module is over the specification. (Latch)	<ol style="list-style-type: none"> 1. The output transient power is too high (the DC BUS is over 900V.) 2. The measurement circuit of the AC/DC module is abnormal. 	<ol style="list-style-type: none"> 1. Remove the UUT and check if the operation is correct. 2. Contact Chroma's service center to fix it.
DD_VO_UVP_S(*)	It means the DC BUS transient voltage of the DC/DC (front) module is under the specification. (Latch)	<ol style="list-style-type: none"> 1. The measurement circuit of the DC/DC module is abnormal. 2. The drive signal of the DC/DC module relay is abnormal or the relay is damaged. 	<ol style="list-style-type: none"> 1. Remove the UUT and check if the operation is correct. 2. Contact Chroma's service center to fix it.
DD_VO_UVP_F(*)	It means the DC BUS transient voltage of the DC/DC (front) module is under the specification. (Latch)	<ol style="list-style-type: none"> 3. The PWM drive signal of the DC/DC module is abnormal. 4. The power components of the DC/DC (front) module are abnormal or damaged. 	

The table below lists the protections of the rear stage module:

Message	Protection	Possible Cause	Troubleshooting
OVP(*)	It means the output voltage of the DD/DC (rear) module circuit is over the specification.	<ol style="list-style-type: none"> 1. The power components of the DC/DC (rear) module are abnormal or damaged. 2. The measurement circuit of the DC/DC (rear) module is abnormal. 	<ol style="list-style-type: none"> 1. Check if the output active load meets the rated value. 2. Contact Chroma's service center to fix it.
SOCP(*)	It means the Source Mode output current of the DC/DC (rear) module is over the limit.	<ol style="list-style-type: none"> 1. The output current is too high (protection occurs when the module current is over 44A.) (Source Mode) 2. The circuit measurement of the DC/DC (rear) module is abnormal. 	<ol style="list-style-type: none"> 1. Remove the UUT and check if the operation is correct. 2. Contact Chroma's service center to fix it.
LOCP(*)	It means the Regen Mode input current of the DC/DC (rear) module is over the limit.	<ol style="list-style-type: none"> 1. The input current is too high (protection occurs when the module current is over 44A). (Regen Mode) 2. The circuit measurement of the DC/DC (rear) module is abnormal. 	<ol style="list-style-type: none"> 1. Remove the UUT and check if the operation is correct. 2. Contact Chroma's service center to fix it.
IL_SHARE(*)	It means the current flow in the DC/DC (rear) module is uneven.	<ol style="list-style-type: none"> 1. The difference between the measured current and the DC/DC (rear) module is 5A. 2. The circuit measurement of the DC/DC (rear) module is abnormal. 	<ol style="list-style-type: none"> 1. Remove the UUT and check if the operation is correct. 2. Contact Chroma's service center to fix it.
SENSE_FAULT(*)	It means the output voltage of the DC/DC (rear) module is detected abnormally.	<ol style="list-style-type: none"> 1. The DC/DC (rear) module output voltage sense is reversed. 2. It occurs when 	<ol style="list-style-type: none"> 1. Remove the UUT and confirm if the voltage sense wiring of the output terminal is

Message	Protection	Possible Cause	Troubleshooting
		the load line loss is over 30V. 3. The measurement circuit of the DC/DC (rear) module is abnormal.	correct. 2. Contact Chroma's service center to fix it.
MODULE_ERR(*)	It means the model identification of the DC/DC module is abnormal.	1. The GPIO pin is abnormal. 2. The hardware resistor is dropped or printed wrong.	Contact Chroma's service center to fix it.
AD_ERR(*)	It means the AC/DC and DC/DC (front) modules are abnormal and notify the DC/DC (rear) module.	The AC/DC and DC/DC (front) modules will notify the DC/DC (rear) module if there is any alarm.	Contact Chroma's service center to fix it.
OTP(*)	It means the internal temperature of the power component in the DC/DC (rear) module is too high.	1. The operating environment temperature is over the temperature limit. 2. The module component is abnormal. 3. It detects circuit malfunction.	1. Eliminate the ambient temperature too high problem. 2. Contact Chroma's service center to fix it.
UTP(*)	It means the internal temperature of the power component in the DC/DC (rear) module is too low.	1. The operating environment temperature is under the temperature limit. 2. The module component is abnormal. 3. It detects circuit malfunction.	1. Eliminate the ambient temperature too low problem. 2. Contact Chroma's service center to fix it.
MOS_SHORT(*)	It means the PWM output signal of the DC/DC (rear) module is abnormal.	1. The DSP components output abnormal PWM signals. 2. FPGA detects circuit malfunction	Contact Chroma's service center to fix it.
HOST_SYNC(*)	It means one of the modules connected to multiple devices is alarmed.	1. The power component of a certain module phase is abnormal or damaged. 2. The module detects abnormal	Contact Chroma's service center to fix it.

Message	Protection	Possible Cause	Troubleshooting
DB_FAULT(*) PWM_CH1_WARN PWM_CH2_WARN PWM_CH3_WARN	The internal power components of the DC/DC (rear) module are short-circuited.	circuits. 1. The power component of a certain phase in the DC/DC module is abnormal or damaged. 2. The power component of a certain phase in the DC/DC module detects an overcurrent analog.	1. Remove the UUT and check if the operation is correct. 2. Contact Chroma's service center to fix it.
AUX_FAULT(*)	It means the auxiliary power of the DC/DC (rear) module is abnormally low.	1. The circuit detection function is abnormal. 2. The auxiliary power of the DC/DC (rear) module is abnormally low.	Contact Chroma's service center to fix it.
OPP	It means the loading of the DC/DC (rear) module exceeds 1.05 times the module power.	The loading of the DC/DC (rear) module is over 1.05 times the module power.	Check the device loading value and the power set on the protection interface.
CALB_WARN	It means the module has no calibrated value or the calibration range is wrong.	The module has no calibrated value or the calibration range is wrong.	Recalibrate the module.

 **Notice**

- The protection message is marked _F(FAST) and _S(SLOW) by a transient and steady state.
- The protection point varies by the measurement error, thus protection circuits may act before reaching the protection point set.
- DC/DC module is divided into the DC/DC (front) module and DC/DC (rear) module.

Appendix C Precautions for Battery Test

Way to safely connect the 63700 DC Electronic Load to the battery

The Chroma 63700 series is a DC electronic load, and one of its typical applications is battery discharge testing. Since the battery is always charged, the internal output of the 63700 has a capacitor. When the 63700 is used to connect the battery, the capacitor will be affected by the voltage difference causing the circuit to generate a surge current which may harm the battery and equipment. Therefore, please do not connect the battery directly to the electronic load. It is recommended to use the following wiring methods for installation to ensure the safety of the electronic load.

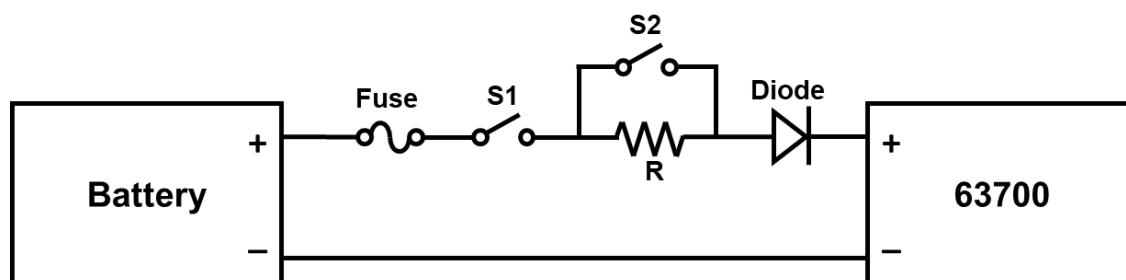

Before connecting the 63700 to the battery, it is necessary to add the component circuits, Relay switch (S1/S2), resistor (R), and fuse (Fuse) to the circuit shown above. For the components selection, S1, S2, resistor, and Fuse must withstand the maximum discharge current specification. In contrast, the current limit resistor R-value must consider the power and the battery's maximum discharge current.

The circuit execution steps are as follows:

- Step 1. First, open the switch S1 & S2 to disconnect them.
- Step 2. Close S1, the current begins to flow through the current limit resistor R, and the 63700 internal output capacitor begins to charge.
- Step 3. Wait for the voltage difference between the 63700 and the battery to be less than 1V.
- Step 4. Close S2 to start the battery discharge test.

Turn Off Step: To stop testing, first stop loading the 63700, and then disconnect S1 and S2 in sequence. This can prevent the battery from consumption discharging through the 63700 circuit when not tested.

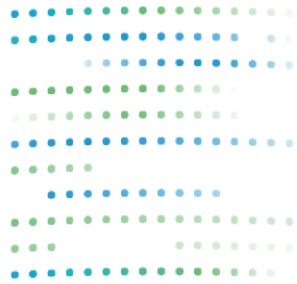

Chroma
Advancing Excellence



**Ihr Ansprechpartner /
Your Partner:**

dataTec AG
E-Mail: info@datatec.eu
datatec.eu

Mess- und Prüftechnik. Die Experten.

Chroma ATE Inc.

88 Wenmao Rd., Guishan Dist., Taoyuan City 333001, Taiwan

T +886-3-327-9999 | F +886-3-327-8898 | www.chromaate.com | info@chromaate.com