

USB Preamplifiers

U7227/8A 10 MHz to 4 GHz

U7227/8C 100 MHz to 26.5 GHz

U7227/8F 2 to 50 GHz



Key Features and Benefits

- Automatic gain correction value with temperature compensation and transfer of calibration data (noise figure and S-parameters) through USB plug and play features for improved noise figure measurements with Keysight N9040/1B UXA and N9010/20/30A/B X-Series signal analyzers
- Excellent noise figure and optimized gain with the X-Series signal analyzers; improves measurement accuracy and minimizes uncertainty
- Provides ultra-broadband operating frequency from 10 MHz up to 50 GHz for various applications
- Rugged and portable design for benchtop measurements or remote front-end applications

Benchtop/Remote Front End Use

In many RF systems, noise figure is known as a key parameter for characterizing a receiver and its ability to detect weak incoming signals combined with self-generated noise. The presence of these signals are typically low level, so adding a reliable preamplifier will greatly increase the sensitivity of your measurement system.

The Keysight Technologies, Inc. U7227/8A/C/F USB preamplifiers are designed to increase signal analyzer sensitivity for measuring low-level signals by reducing instrument noise figure. Reduced instrument noise figure also reduces noise figure measurement uncertainty in most cases. Powered on a USB platform, compact and portable, the USB preamplifiers eliminates the need for an external power supply and is ideal for either benchtop measurements or on remote front end applications.

When connected to the Keysight X-Series signal analyzers, the USB preamplifiers can automatically configure the signal analyzer to detect the specific preamplifier connected. The preamplifier will then download the embedded calibration data such as gain, noise figure and S-parameters. The calibration data provides accurate correction data and more repeatable results for each measurement made.

The combined solution of the Keysight U7227/8A/C/F USB preamplifiers and the X-Series signal analyzers delivers the most efficient test setup, highest accuracy and lowest measurement uncertainty for noise figure measurement applications up to 50 GHz.

Improve Noise Figure Measurements

Adding a preamplifier to a noise figure measurement system can significantly reduce the overall system noise figure. The total system noise is dominated by the noise figure of the preamplifier.

$$F_{new} = F_{pa} + \frac{F_{sys} - 1}{G_{pa}}$$

Where F and G are noise figure and preamplifier gain, both in linear terms.

$$NF_{sys} = 10 \log (F_{sys}) \text{ in dB}$$

For systems with a single preamplifier, where the gain of the preamplifier is greater than or equal to the spectrum analyzer noise figure, the system noise figure is approximately equal to the noise figure of the preamplifier.

Increase Sensitivity and Speed

Measurement system sensitivity for measuring low-level signals can be improved by adding a preamplifier. Alternatively, boosting the sensitivity of your signal or spectrum analyzer with the U7227/8A/C/F USB preamplifiers can provide a means for achieving a faster measurement speed. An analyzer with low noise figure allows you to use a wider resolution bandwidth, yet achieve the same sensitivity. Sweep times can improve one hundred times for each decade increase in bandwidth. The U7227/8A/C/F USB preamplifiers have gain and noise figure characteristics that optimize dynamic range and sensitivity.

Low Noise Amplifier Measurements

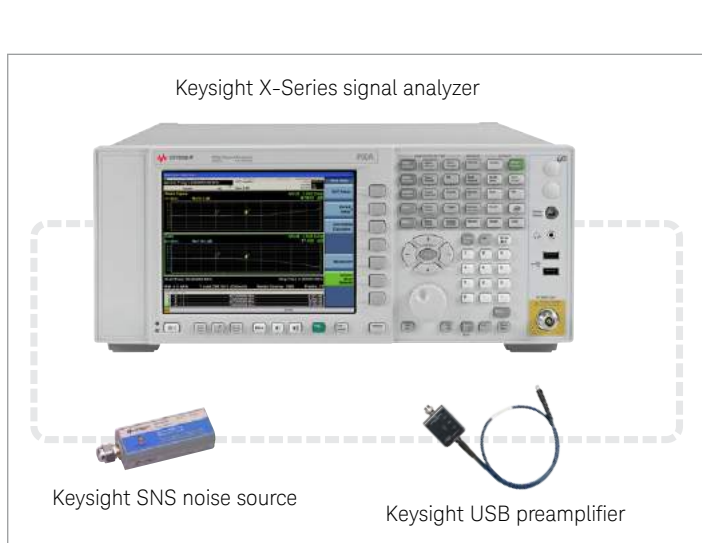

Figure 1. USB Preamplifier calibration setup

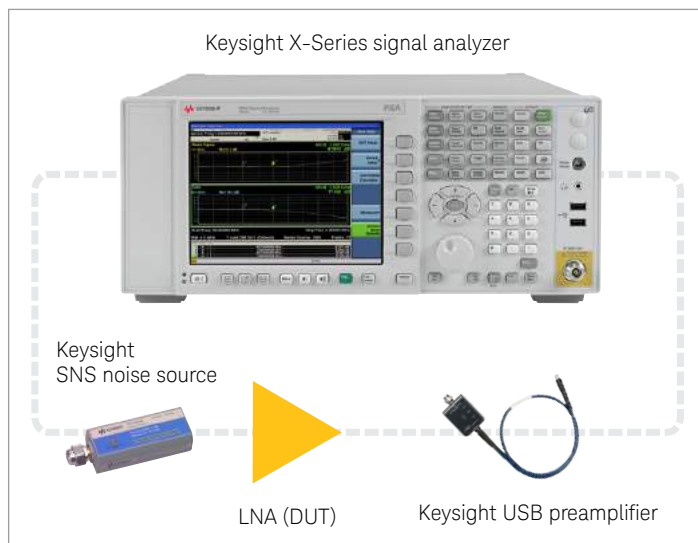

Figure 2. LNA noise figure measurement setup

Figure 2 above shows the typical setup with a Keysight X-Series signal analyzer for noise figure measurements on a low noise amplifier (LNA) device using the Y-factor measurement technique. The method begins with the calibration setup shown in Figure 1; connecting the USB preamplifier and noise source to the X-Series signal analyzer, setting a start and stop frequency, then calibrate the system through the noise figure measurement application on the signal analyzer. The next step is to insert the LNA and observe the gain and noise figure for the measurement as shown in Figure 2. The built-in uncertainty calculator for the signal analyzer will perform the calculation work for you by importing uncertainties from the specification guide, calibration data from the SNS (noise source), and the gain, noise figure, and match terms of the USB preamplifiers. The uncertainty calculator will also import the LNA noise figure and gain terms from the previous measurement.

Mixer Measurements

For noise figure measurements on frequency-converting devices such as mixers, a more complicated setup is required.

Figure 4 shows a setup using a low pass filter (LPF) after the mixer (DUT) to remove any LO feed through. First the measurement system will require calibration (Figure 3) which includes calibrating with the LPF to include it in the measurement system. When the calibration process is complete, the DUT will be inserted between the low pass filter and the SNS source with the LO input being connected to a source. Noise figure measurements can now be carried out for the DUT.

Built-in uncertainty calculators do not work for frequency converting devices. For this application, you will need the RF (input) and IF (output) VSWR from the data sheet of the mixers to estimate the uncertainty of the system being measured.

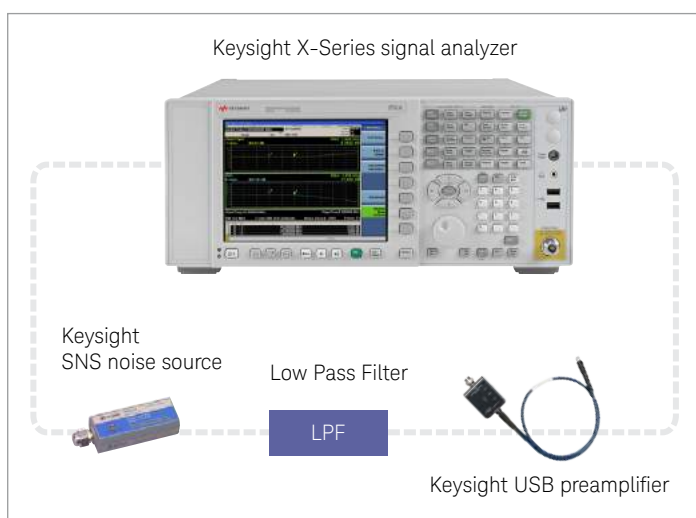

Figure 3. USB preamplifier calibration setup

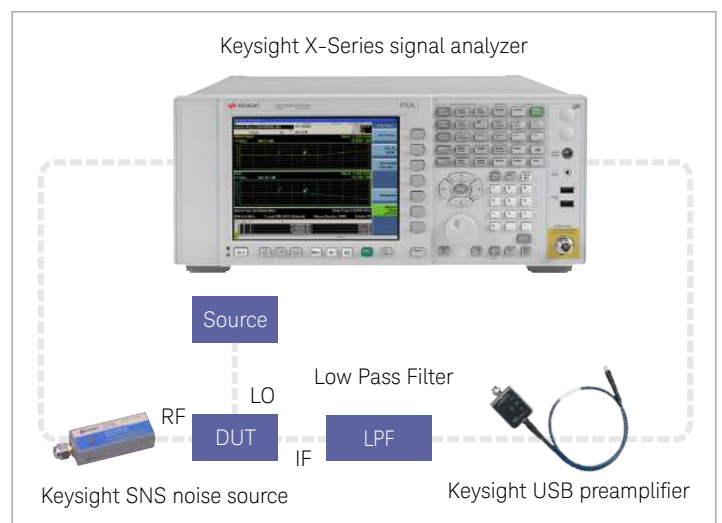

Figure 4. Mixer noise figure measurement setup

Specifications*

Specifications refer to the performance standards or limits against which the U7227A/C/F USB preamplifiers are tested.

Typical characteristics are included for additional information only and they are not specifications. Those are denoted as “typical”, “nominal” or “approximate” and are printed in *italic*.

Specifications subject to change.

Specification	U7227/8A	U7227/8C	U7227/8F
Frequency	10 MHz to 4 GHz	100 MHz to 26.5 GHz	2 to 50 GHz
Gain (dB)	10 to 100 MHz: > 16 100 MHz to 4 GHz: > 0.5F + 17	100 MHz to 26.5 GHz: > 16.1 + 0.26F	2 to 50 GHz: > 16.5 + 0.23F
Input return loss (Input SWR)	10 to 100 MHz: > 5 dB (3.57) 100 MHz to 2 GHz: > 13.5 dB (1.54) 2 to 3 GHz: > 11.5 dB (1.73) 3 to 4 GHz: > 10 dB (1.93)	100 MHz to 4 GHz: > 15 dB (1.43) 4 to 26.5 GHz: > 8 dB (2.32)	2 GHz to 40 GHz: > 8 dB (2.32) 40 to 44 GHz: > 6 dB (3.00) 44 to 50 GHz: > 5 dB (3.57)
Output return loss (Output SWR)	10 MHz to 4 GHz: > 18 dB (1.29)	100 MHz to 4 GHz: > 18 dB (1.29) 4 to 26.5 GHz: > 11 dB (1.78)	U7227F 2 to 4 GHz: > 18 dB (1.29) 4 to 40 GHz: > 11 dB (1.78) 40 to 50 GHz: > 8 dB (2.32) U7228F 2 to 4 GHz: > 18 dB (1.29) 4 to 26.5 GHz: > 11 dB (1.78) 26.5 to 40 GHz: > 8 dB (2.32) 40 to 50 GHz: > 6 dB (3.00)
Noise figure	10 to 100 MHz: < 5.5 dB 10 MHz to 4 GHz: < 5 dB	100 MHz to 4 GHz: < 6 dB 4 to 6 GHz: < 5 dB 6 to 18 GHz: < 4 dB 18 to 26.5 GHz: < 5 dB	2 to 4 GHz: < 10 dB 4 to 40 GHz: < 8 dB 40 to 44 GHz: < 9 dB 44 to 50 GHz: < 10 dB
Plug and play USB connection	Yes	Yes	Yes
Optimized gain slope for better spectrum analysis	Yes	Yes	Yes
Automatic gain compensation	Yes	Yes	Yes
Automatic temperature compensation	Yes	Yes	Yes

* Specifications are tested and measured with an operating temperature of 23 °C.

* “F” signifies frequency in GHz

Supplemental characteristics	U7227/8A	U7227/8C	U7227/8F
Data storage	EEPROM	EEPROM	EEPROM
Bias voltage and current	USB 5 Vdc at 360 mA	USB 5 Vdc at 400 mA	USB 5 Vdc at 460 mA
Survival input power	+ 17 dBm	+ 17 dBm	+ 10 dBm
Power dissipation (typical)	1.8 W	2 W	2.3 W
Temperature coefficient (typical)	-0.009 dB/C	-0.03 dB/C	-0.18 dB/C
Pin depth	0 to -0.05 mm (0 to -0.002 in)	0 to -0.05 mm (0 to -0.002 in)	0 to -0.05 mm (0 to -0.002 in)
RF connector	3.5 mm (m)	3.5 mm (m)	2.4 mm (m)

Amplitude accuracy (typical)

		Total measurement uncertainty, 95th dB	Interpolation error, 2σ
0	0.01 to 3.6 GHz	0.036	0.0326
1	3.5 to 8.4 GHz	0.085	0.0267
2	8.3 to 13.6 GHz	0.091	0.0188
3	13.5 to 17.1 GHz	0.096	0.0354
4	17.0 to 26.5 GHz	0.106	0.1138
5	26.4 to 34.5 GHz	0.153	0.1082
6	34.4 to 50 GHz	0.238	0.3438

Input VSWR (typical)

Model	Frequency range	95th percentile VSWR
U7227/8A	0.01 to 4 GHz	1.811
U7227/8C	0.1 to 26.5 GHz	2.073
U7227/8F	2 to 50 GHz	2.265

Note: The 95th percentile VSWR shown is actually the 95th percentile of a Rayleigh distribution that would give similar mismatch uncertainty to that from an observed example preamplifier. The actual 95th percentile distribution is smaller than this, but it only modestly matches a Rayleigh distribution. Still, Keysight recommends using the methods outlined in Application Note Fundamentals of RF and Microwave Power Measurements (part number 5988-9215EN) and companion Average Power Sensor Measurement Uncertainty Calculator to compute mismatch uncertainty. Use this 95th percentile VSWR information and the Rayleigh model (Case C or E in the application note) with that process.

Typical Performance

U7227/8A 10 MHz to 4 GHz USB preamplifier

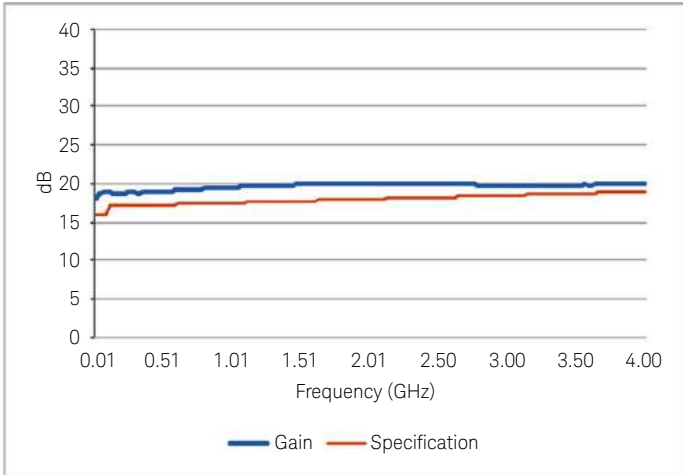

Figure 5. U7227/8A Gain versus frequency (typical)

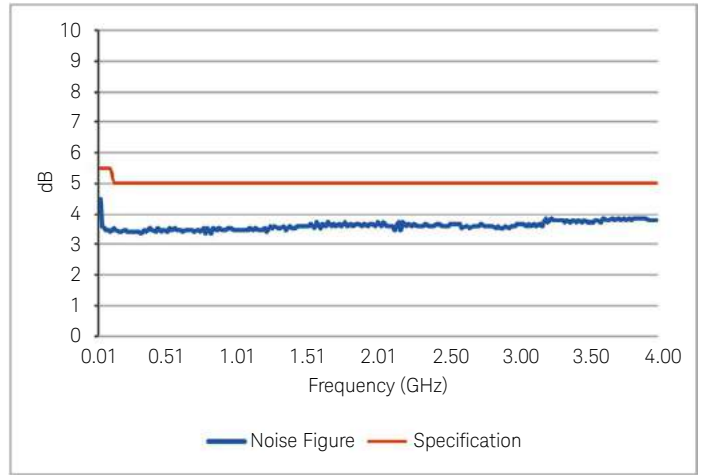

Figure 6. U7227/8A Noise figure versus frequency (typical)

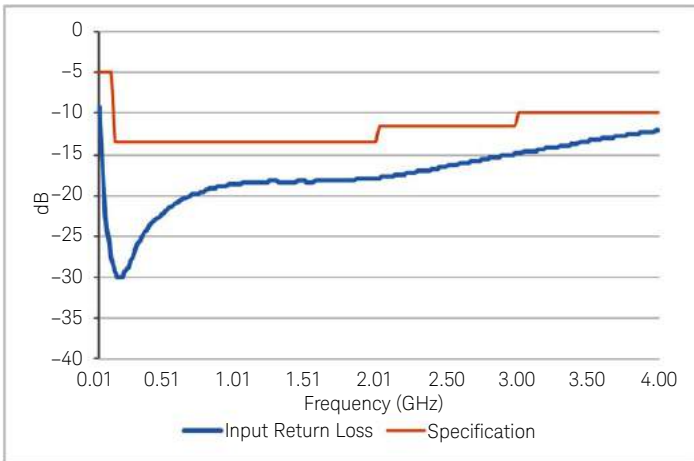

Figure 7. U7227/8A return loss versus frequency (typical)

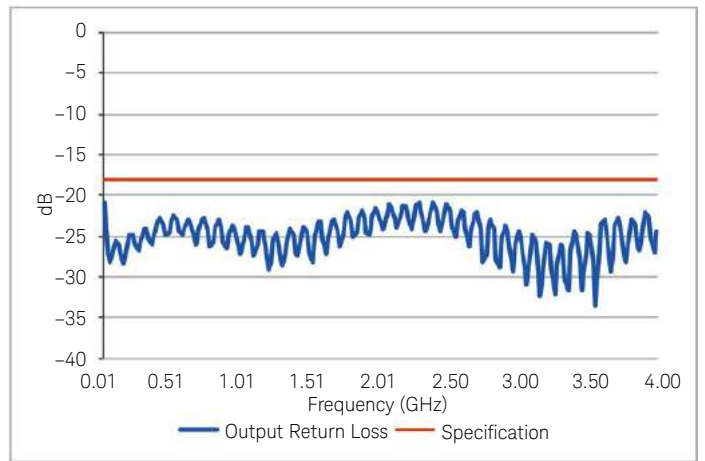

Figure 8. U7227/8A Output return loss versus frequency (typical)

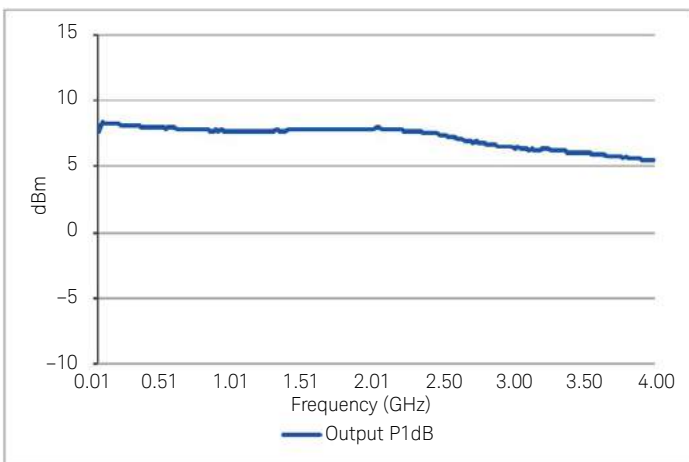

Figure 9. U7227/8A Output P1dB versus frequency (typical)

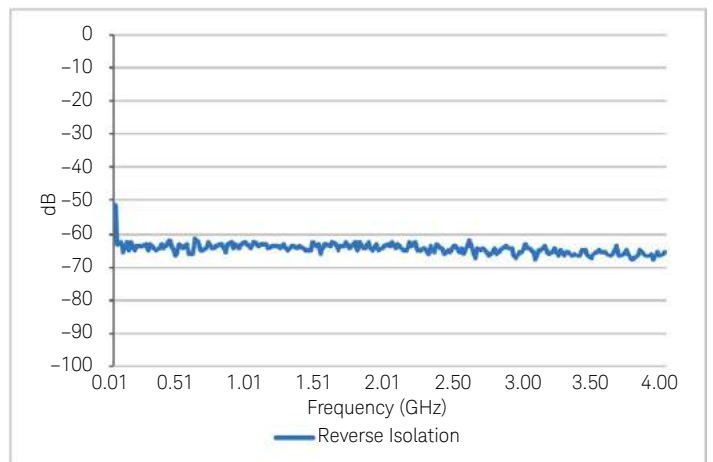

Figure 10. U7227/8A Reverse isolation versus frequency (typical)

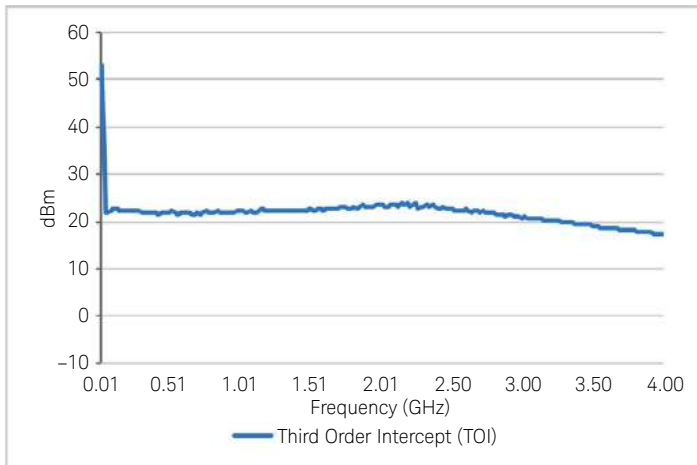

Figure 11. U7227/8A Third order intercept (TOI) versus frequency (typical)

Typical Performance

U7227/8A 100 MHz to 26.5 GHz USB preamplifier

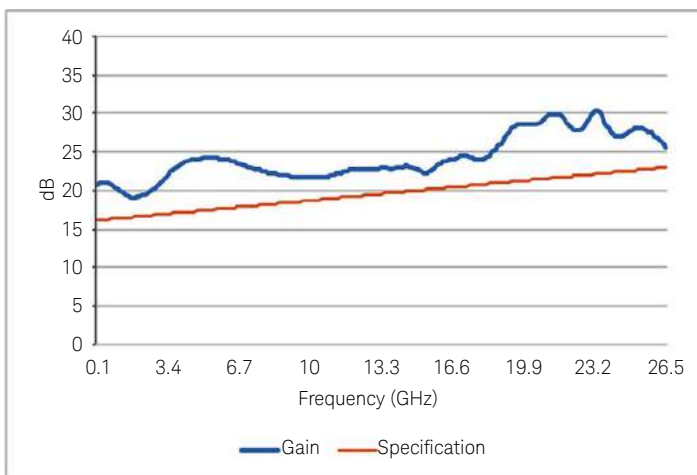

Figure 12. U7227/8C Gain versus frequency (typical)

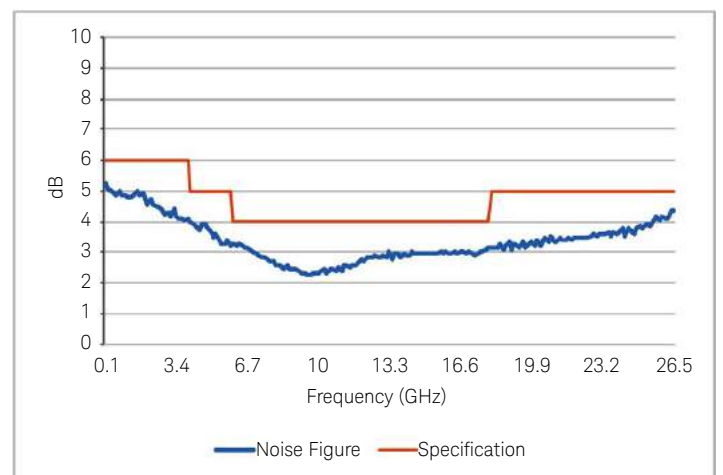

Figure 13. U7227/8C Noise figure versus frequency (typical)



Figure 14. U7227/8C Input return loss versus frequency (typical)

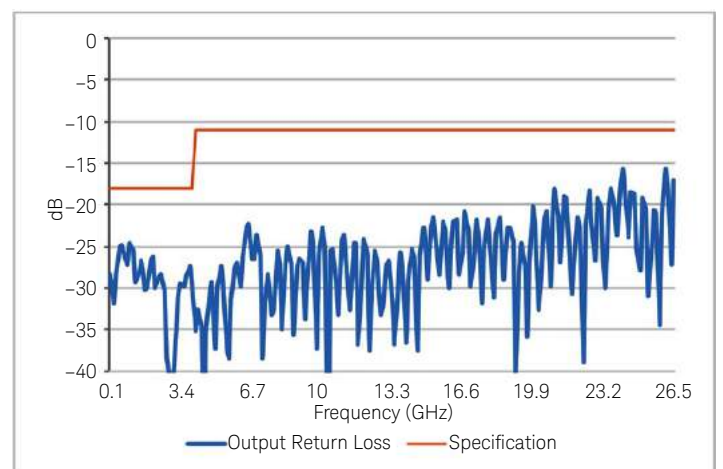

Figure 15. U7227/8C Output return loss versus frequency (typical)

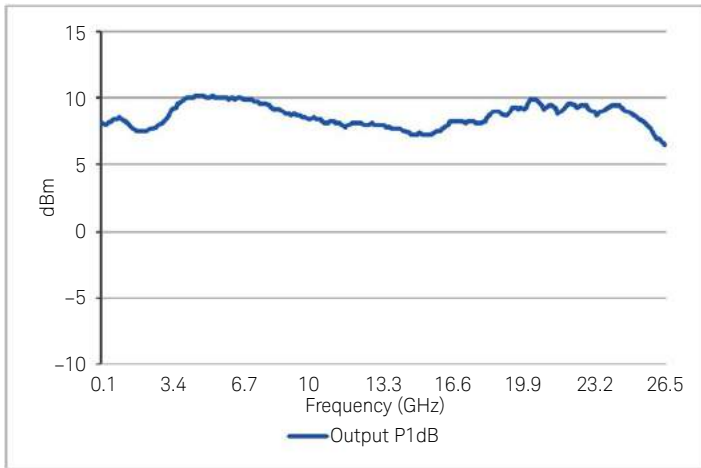

Figure 16. U7227/8C Output P1dB versus frequency (typical)

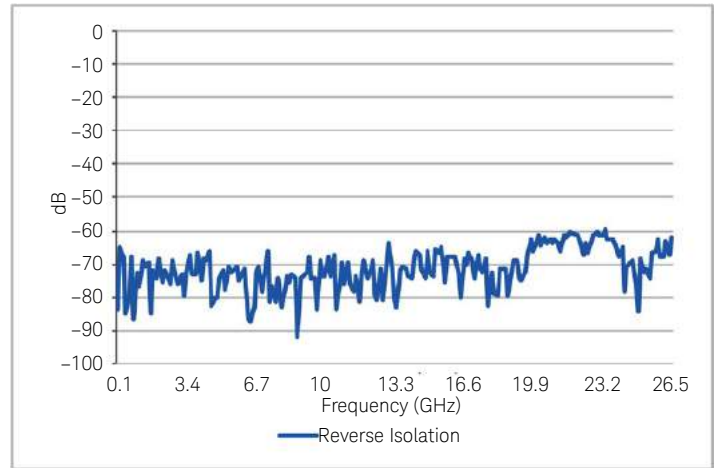

Figure 17. U7227/8C Reverse isolation versus frequency (typical)

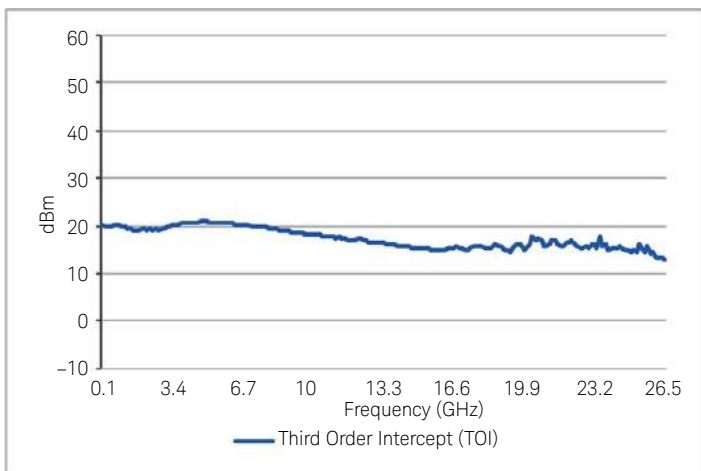

Figure 18. U7227/8C Third order intercept (TOI) versus frequency (typical)

Typical Performance

U7227/8F 2 to 50 GHz USB preamplifier

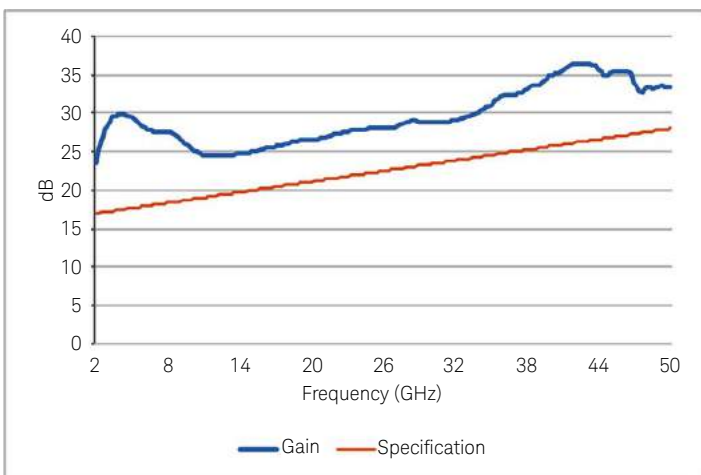

Figure 19. U7227/8F Gain versus frequency (typical)

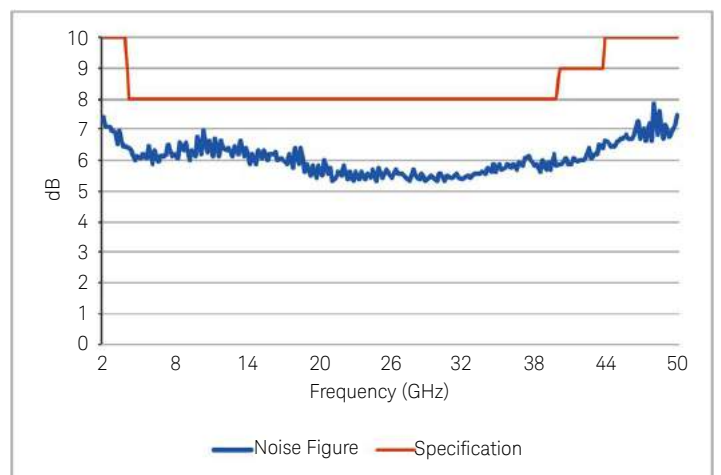

Figure 20. U7227/8F Noise figure versus frequency (typical)

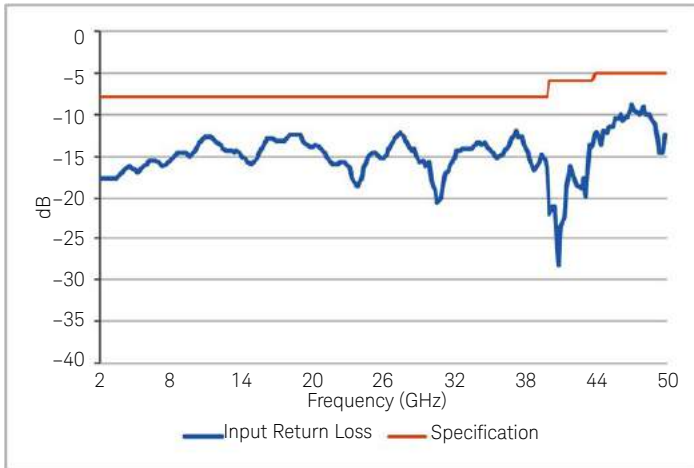

Figure 21. U7227/8F Input return loss versus frequency (typical)

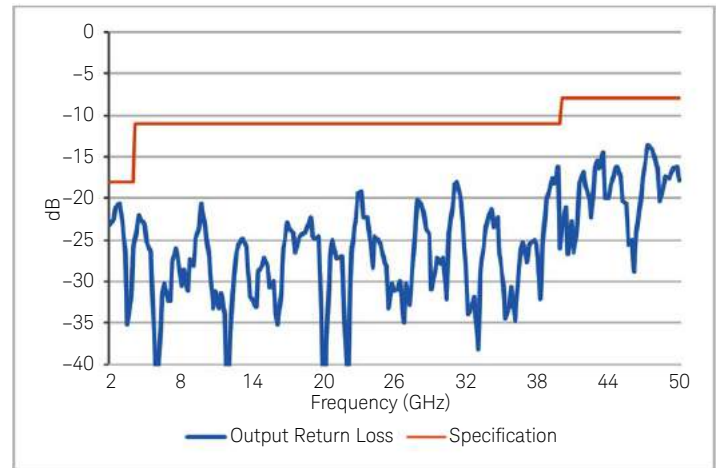

Figure 22. U7227/8F output return loss versus frequency (typical)

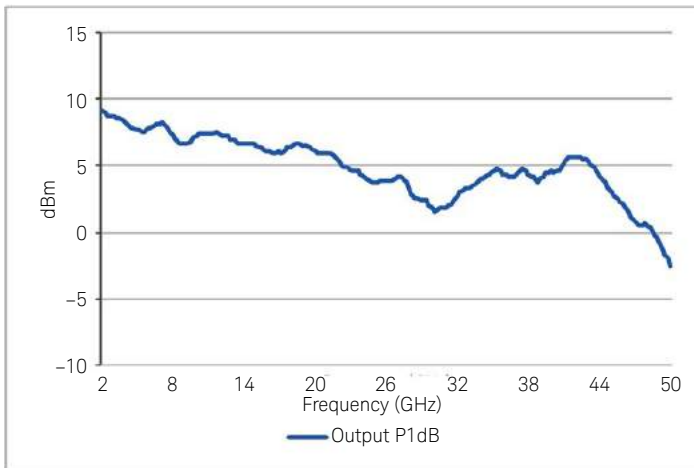

Figure 23. U7227/8F output P1dB versus frequency (typical)

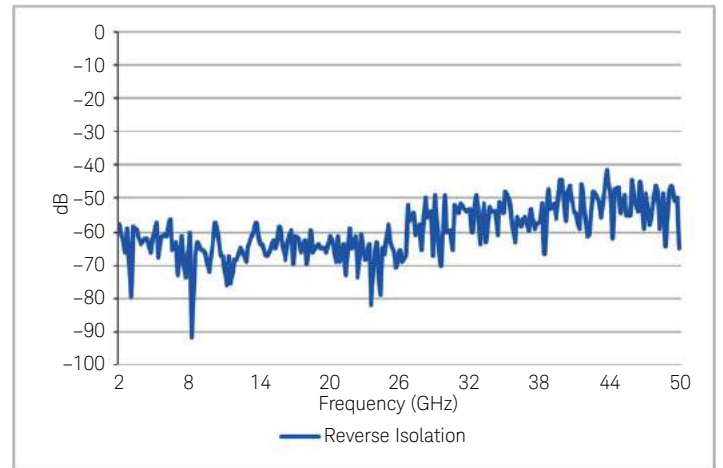

Figure 24. U7227/8F Reverse isolation versus frequency (typical)

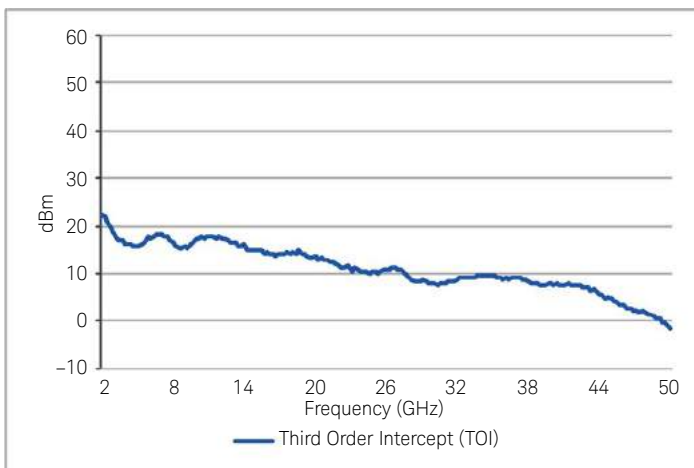

Figure 25. U7227/8F third order intercept (TOI) versus frequency (typical)

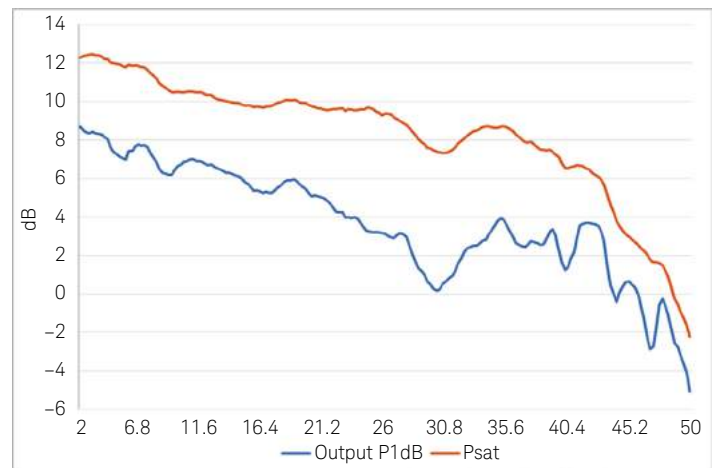

Figure 26. U7227/8F output power versus frequency (typical)

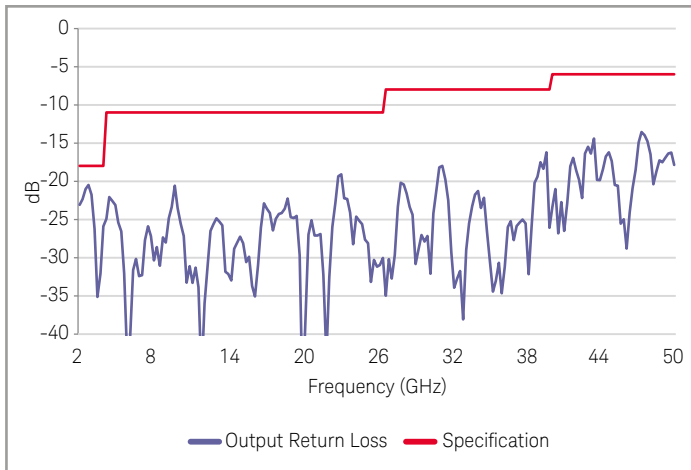

Figure 27. U7228F output return loss versus frequency (typical)

Environmental Specifications

Keysight U7227/8A/C/F USB preamplifiers fully comply with Keysight's product operating environmental specifications. The following are the summarized environmental specifications for these products.

Temperature range

Operating 0 to 55 °C

Storage -40 to 70 °C

Relative humidity

Operating 50 % to 95 % RH at 40 °C

Storage 90 % RH at 65 °C

Shock

End-use handling shock 1.6 m/s

Transportation shock 50 g, 8 m/s

Vibration

Operating Random: 5 to 500 Hz, 0.21 g rms

Survival Random: 5 to 500 Hz, 2.09 g rms

Swept sine: 5 to 500 Hz, 0.5 g rms

ESD immunity

Direct discharge 6 kV per IEC 61000-4-2

Air discharge 15 kV per IEC 61000-4-2

Mechanical Dimension

Mechanical dimensions do not include RF cables and connectors

Model	Weight	Pin depth	Height	Width	Length
U7227/8A	0.38 kg (0.84 lbs)	0 to - 0.05 mm	35.50 mm (1.40 in)	60.00 mm (2.36 in)	75.00 mm (2.95 in)
U7227/8C		(0 to - 0.002 in)			
U7227/8F					

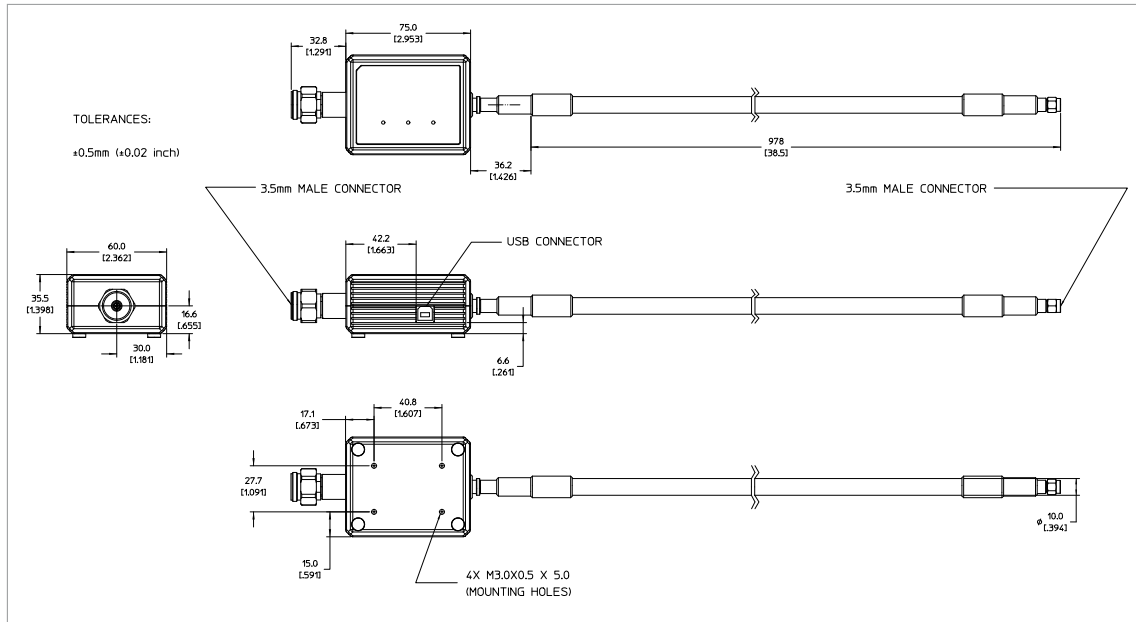

Figure 28. Mechanical dimensions for U7227A and U7227C USB preamplifiers

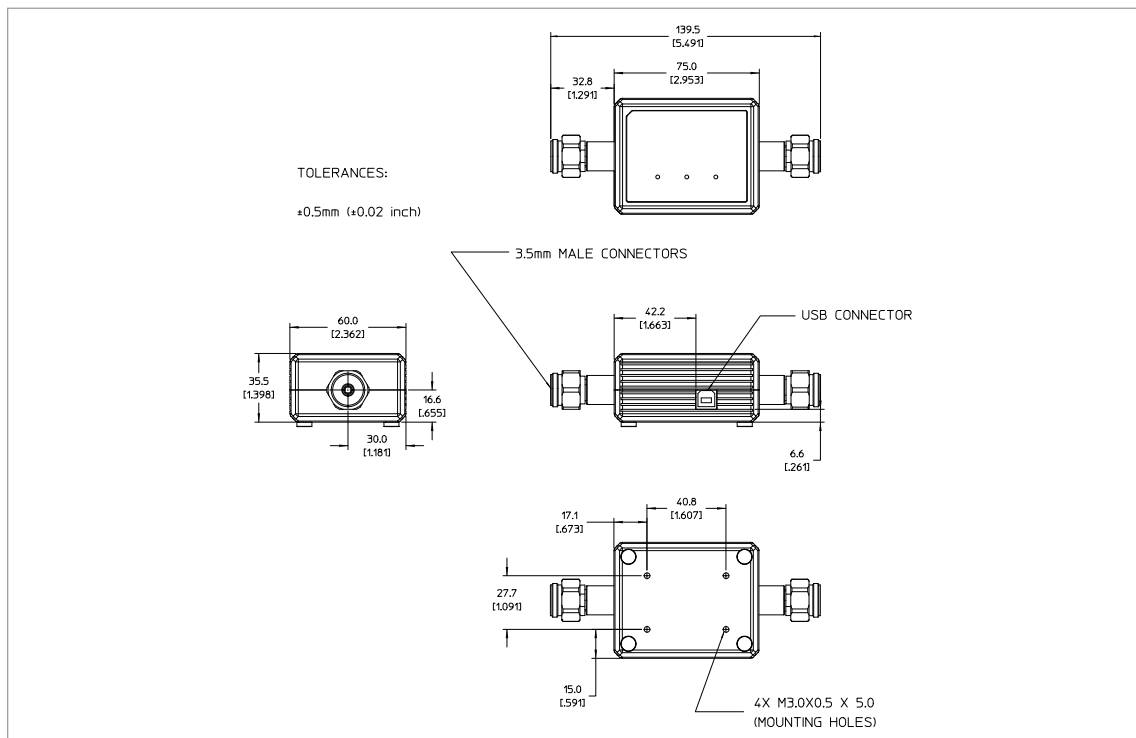

Figure 29. Mechanical dimensions for U7228A and U7228C USB preamplifiers

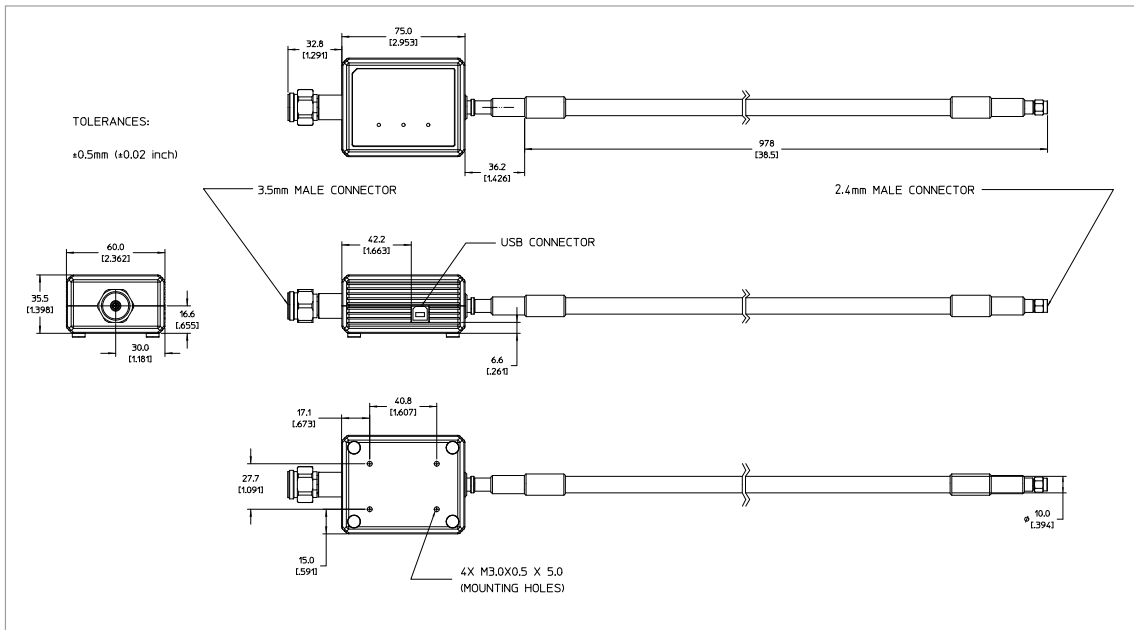

Figure 30. Mechanical dimensions for U7227F USB preamplifier

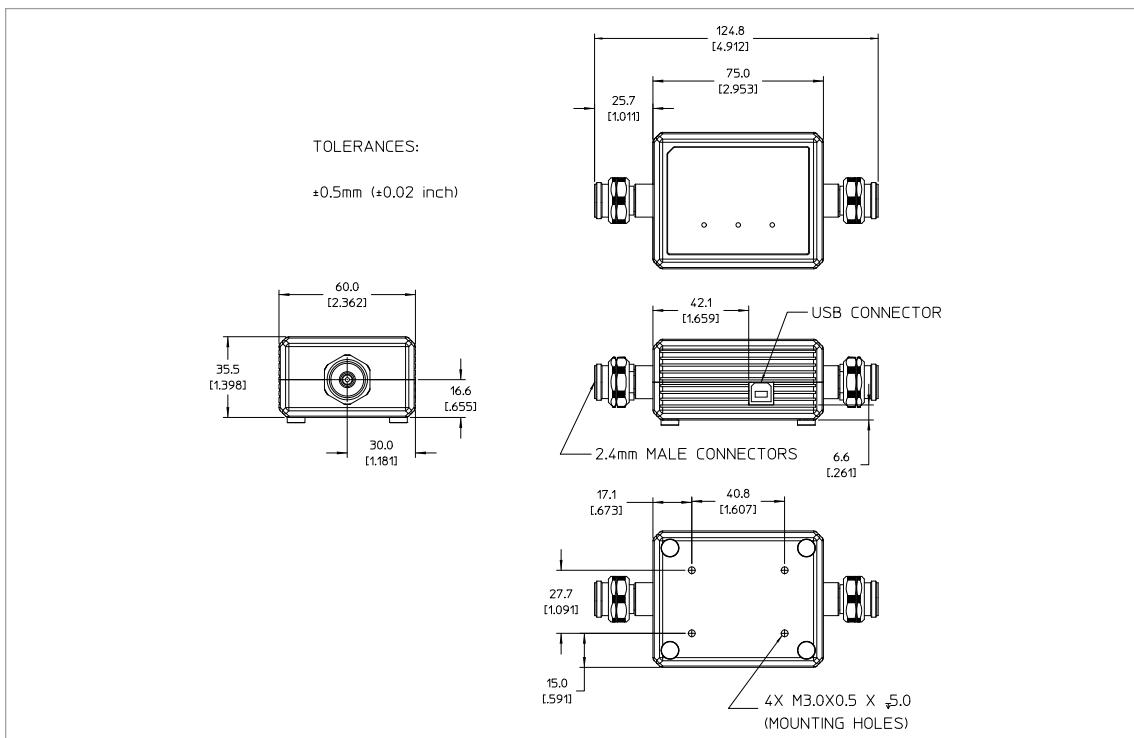

Figure 31. Mechanical dimensions for U7228F USB preamplifier

Ordering Information

U7227/8A	10 MHz to 4 GHz USB Preamplifier ¹
U7227/8C	100 MHz to 26.5 GHz USB Preamplifier ¹
U7227/8F	2 to 50 GHz USB Preamplifier ²

1. The product ships with one 3.5 (f) to Type-N (m) adapter.
2. The product ships with one 2.4 (f) to 2.4 (f) adapter.

Deutschlands größter B2B-Onlineshop für Mess- und Prüftechnik.

dataTéc

Mess- und Prüftechnik, Die Experten.

Ihre Vorteile:

- > Eine unschlagbare Auswahl namhafter Hersteller
- > Hohe Lagerkapazität und kurze Wege
- > Bundesweite Lieferung und schnelle Zustellung meist innerhalb eines Tages
- > Mehrere tausend Mess- und Prüfgeräte
- > Tagesaktuelle Preise und Promotions
- > Warenkorbrabatt bei Online-Bestellung
- > Versandkostenfrei ab € 50,-
- > Dokumenten-Download u. v. m.



Wir haben die Lösungen für Ihre Mess- aufgaben.

dataTec

Mess- und Prüftechnik, Die Experten.

Ihre Vorteile:

- > Diplom-Ingenieure, Elektronik- und Elektrotechniker
- > Langjährige Praxiserfahrung und hohe Kompetenz
- > Bundesweit über 20 praxiserfahrene und herstellerzertifizierte Vertriebsingenieure im Außendienst bei Ihnen vor Ort

Experten für:

- > Oszilloskope
- > Spektrum- / Netzwerkanalysatoren
- > Netzgeräte / Stromversorgungen
- > Thermografie / Temperatur
- > Prüfgeräte VDE / Netzanalyse
- > u. v. m.



**Technische
Beratung
und Service.**