

# B2961B and B2962B

## 6.5 Digit Low Noise Power Source

1 ch/2 ch, 210 V, 3 A DC/10.5 A Pulse, 31.8W,  
100 nV/10 fA Resolution



Mess- und Prüftechnik. Die Experten.

Ihr Ansprechpartner /  
Your Partner:

dataTec AG  
E-Mail: [info@datatec.eu](mailto:info@datatec.eu)  
>>> [www.datatec.eu](http://www.datatec.eu)

 **KEYSIGHT**  
Authorized Premium  
Distributor

## Table of Contents

Impressive 6.5 Digit 100 nV/10 fA Resolution, 10 $\mu$ Vrms Ultra Low Noise and Innovative Source Functions Accelerate Your Research and Development.....	3
Key Features and Benefits.....	4
Superior Resolution and Wide Bipolar Ranges Meet your Most Challenging Test and Evaluation Needs .....	5
Best-in-Class Noise Performance (10 $\mu$ Vrms) Unlocks the True Characteristics of Your Devices and Samples.....	7
Intuitive Front-Panel GUI and Wide 4.3" Color LCD Maximize Test and Debug Efficiency .....	10
GUI Based Intuitive Front Panel Design with Rich Standard Interfaces for Your Bench-Top Needs .....	11
Flexible Source Functions Beyond a DC Instrument Remove Your Test Restrictions.....	12
Programmable Output Resistance and DC Voltage/Current Output Emulation Capabilities Solve Real-World Measurement Challenges.....	14
Multiple Communication Methods and Software Provide Flexible and Convenient Remote Control Options.....	16
Key Specifications .....	18
Specifications .....	19
Source Supplemental Characteristics .....	21
Furnished Accessories .....	36
Ordering Information.....	36

## Impressive 6.5 Digit 100 nV/10 fA Resolution, 10 $\mu$ Vrms Ultra Low Noise and Innovative Source Functions Accelerate Your Research and Development

### Revolutionary power supply/source meets both existing and future test needs

Power supplies/sources are essential instruments for test and evaluation across the electronics industry. The on-going industry trends of reduced power consumption and faster communication data rates increasingly require power sources that can support lower levels of current and voltage. These requirements mandate that power supplies/sources meet ever higher levels of performance.

The Keysight B2961B/B2962B 6.5 Digit Low Noise Power Source is a new bench-top power supply/source with revolutionary capabilities and functions not previously available. Its unique features include bipolar current sourcing and sinking, a programmable output resistance feature, and a time-domain waveform viewer supported in the graphical user interface (GUI).

You can choose between 1-channel (B2961B) and 2-channel (B2962B) models, allowing you to select the exact amount of bench-top power source performance to meet your testing needs.

- Best-in-class 6.5 digit resolution (100 nV/10 fA minimum resolutions)
- Wide bipolar (4-quadrant) voltage/current ranges (210 V/3 A DC, 10.5 A Pulse)
- Ultra low noise filter (10  $\mu$ Vrms, 1 nV/ $\sqrt{\text{Hz}}$  at 10 kHz)
- Intuitive graphical user interface with wide 4.3" color LCD
- Convenient 4.5 digit voltage/current monitor
- Time domain waveform viewer for quick check and debug
- Precision 1 mHz –10 kHz arbitrary waveform generation capability
- Flexible programmable output resistance function

In addition to these innovative bench-top power supply/source features, the B2961B/B2962B can be controlled remotely using Keysight PC-based Pathwave BenchVue, PW9251A PathWave IV Curve Software or through any LXI compliant web browser. These capabilities simplify the task of incorporating measurement data and graphs into reports and presentations.

The superior performance and innovative functions of the B2961B/B2962B cover a broad range of test applications.

## Key Features and Benefits

Feature	Benefit
Best-in-class resolution and wide bipolar range <ul style="list-style-type: none"> <li>• 6.5 digit (100 nV/10 fA resolution)</li> <li>• 210 V and 3 A (DC)/10.5 A (pulsed) ranges</li> <li>• 4-quadrant operation</li> </ul>	Very precise test and evaluation can be performed within a wide 4-quadrant voltage and current range.
External ultra low noise filter (option) <ul style="list-style-type: none"> <li>• 10 <math>\mu</math>Vrms (10 Hz – 20 MHz)</li> <li>• 1 nVrms/<math>\sqrt{\text{Hz}}</math> at 10 kHz</li> </ul>	Reveal more of the true characteristics of your noise-sensitive devices and samples than ever before.
Intuitive GUI implemented on 4.3" color LCD <ul style="list-style-type: none"> <li>• 4.5 digit voltage/current monitor</li> <li>• Time domain waveform viewer</li> </ul>	Improved test and debug efficiency without the need for a PC.
Precision 1 MHz –10 kHz arbitrary waveform generation capability <ul style="list-style-type: none"> <li>• Voltage and current waveform generation up to 210 V/3 A</li> <li>• Support for six built-in waveforms and a user-defined arbitrary waveform</li> </ul>	Goes beyond simple DC measurement and allows you to perform complex and more sophisticated testing of your devices and samples.
Versatile programmable output resistance function <ul style="list-style-type: none"> <li>• Constant mode</li> <li>• Voltage/current emulation mode</li> </ul>	Enables you to simulate a wide variety of devices and sample types.

### A wide variety of B2961B/B2962B applications

To reduce power consumption battery-powered devices continue to reduce their supply voltage levels, which requires ever more precise power sources to accurately characterize device behavior. Noise performance requirements also continue to become more stringent in application areas such as mobile communications due to higher data rates and faster clock frequencies. These technology trends make the testing of advanced products increasingly difficult due to their extreme sensitivity to noise and other external disturbances.

As a result, power supplies/sources with more precision, better noise performance and more versatile sourcing functions are now required. The B2961B/B2962B meet these requirements, and they can be used for a wide variety of applications that permit you to perform critical tests and evaluations that have not been previously possible.

In addition, the B2961B/B2962B's superior performance and innovative functions make these instruments ideal companion power supplies/sources for use with other instruments such as network analyzers, spectrum analyzers, digital multimeters, and nano-voltmeters.

## Application examples

- A/D and D/A converters
- High precision analog IC and circuitry
- RFICs and circuitry
- Medical applications
- Cable/wire harnesses evaluation
- Voltage controlled oscillators (VCOs)
- Sensor devices and transducers
- Solar cells and the interface circuitry
- Electrochemical applications
- Research and education
- Crystal oscillators
- Current source for small voltage measurement
- Battery management
- Advanced materials evaluation

## Superior Resolution and Wide Bipolar Ranges Meet your Most Challenging Test and Evaluation Needs

### 6.5 digit resolution enables precise analog-to-digital converter evaluation

evaluation. For an 8-bit ADC, a 1 V (peak to peak) signal would have a minimum step voltage of 3.9 mV. In this case a power source with 4.5 digit resolution is sufficient to use for the DC input voltage. However, for an ADC with 14-bits or more, 4.5 digit resolution is not enough. In this case the B2961B/B2962B's best-in-class 6.5-digit sourcing resolution is required in order to properly evaluate the ADC circuit.

ADC Resolution	Steps	Min Step Voltage	Conventional power supply resolution (4.5 digit/ Min 100 $\mu$ V)	B2961B/B2962B resolution (6.5 digit/ Min 1 $\mu$ V)
8-bit	256	3.9 mV	√	√
10-bit	1,024	1.0 mV	√	√
12-bit	4,096	244 $\mu$ V	√	√
14-bit	16,384	61 $\mu$ V		√
16-bit	65,536	15 $\mu$ V		√

Figure 1. Resolution comparison: ADC with 1 V<sub>pp</sub> (Full Scale)

Wide bipolar range (100 nV to 210 V, 10 fA to 10.5 A) permits characterization of many types of devices and samples

The wide bipolar (four-quadrant) voltage and current ranges of the B2961B/B2962B are capable of supporting both current and future testing needs. In addition, since they support both very small and very large current and voltage signal levels the B2961B/B2962B can often replace several other bench-top instruments. As shown in Figure 2, you can program any voltage and current value within the B2961B/B2962B's wide output range without worrying about any zero-crossing glitches.

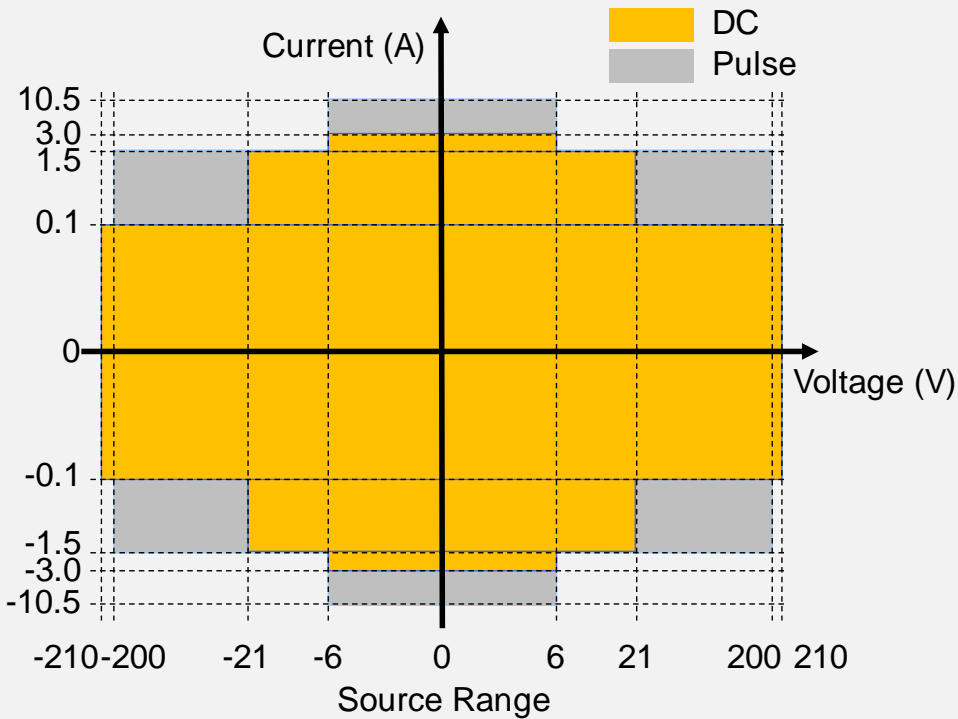

Figure 2. Wide bipolar voltage and current ranges (4-quadrant operation)

## Fast settling time increases your test efficiency

Unlike most conventional power supplies/sources, the B2961B/B2962B can quickly settle to their final value with 6.5 digit resolution throughout their entire output ranges. This reduces test times and improves measurement efficiency, especially when making multiple tests in sequence. See Figure 3.

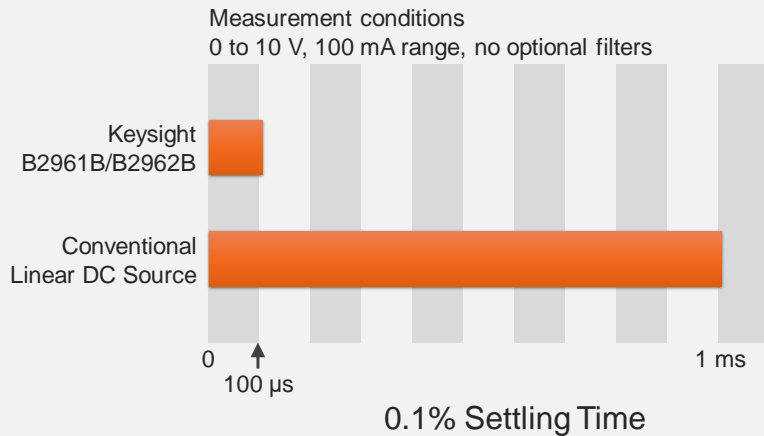

Figure 3. Fast settling time than conventional DC sources

## Best-in-Class Noise Performance (10 $\mu$ Vrms) Unlocks the True Characteristics of Your Devices and Samples

### Three optional filters available for different test needs

For applications requiring ultra-low noise performance, the B2961B/B2962B supports three external filter options. This provides you with the flexibility to select the noise filter price/performance point that best meets your needs. The low noise filter (LNF) provides the same level of RMS noise as linear regulator-based power supplies and sources, while the high current ultra low noise filter (HC-ULNF) and the ultra low noise filter (ULNF) reduces noise to an impressive 10  $\mu$ Vrms. See Figure 4.



Figure 4. Optional external noise filters can meet your most stringent noise requirements

## HC-ULNF and ULNF provide unprecedented low-noise performance (10 $\mu\text{Vrms}$ and 1 $\text{nVrms}/\sqrt{\text{Hz}}$ at 10 kHz) in a low-cost bench-top instrument

As shown in Figure 5 both HC-ULNF and ULNF reduce the voltage noise of the B2961B/B2962B to 10  $\mu\text{Vrms}$  in the frequency range of 10 Hz – 20 MHz. The differences between HC-ULNF and ULNF are voltage and current coverage. HC-ULNF allow it to source up to 21 V and 500 mA, and ULNF allowing up to 42 V and 105 mA. This outstanding low noise performance can be used to evaluate noise-sensitive devices and circuits such as ADC/DAC as well as many other types of analog and RF ICs. In addition, see Figure 6. the HC-ULNF and ULNF minimizes the noise density to 1  $\text{nVrms}/\sqrt{\text{Hz}}$  at 10 kHz, which is required for the phase noise evaluation of oscillator circuits such as VCOs, crystal oscillators, etc. There are two user-selectable output impedance settings, 2-wire (50  $\Omega$ ) and 4-wire (low impedance close to zero), to provide optimal flexibility when characterizing your devices and samples.

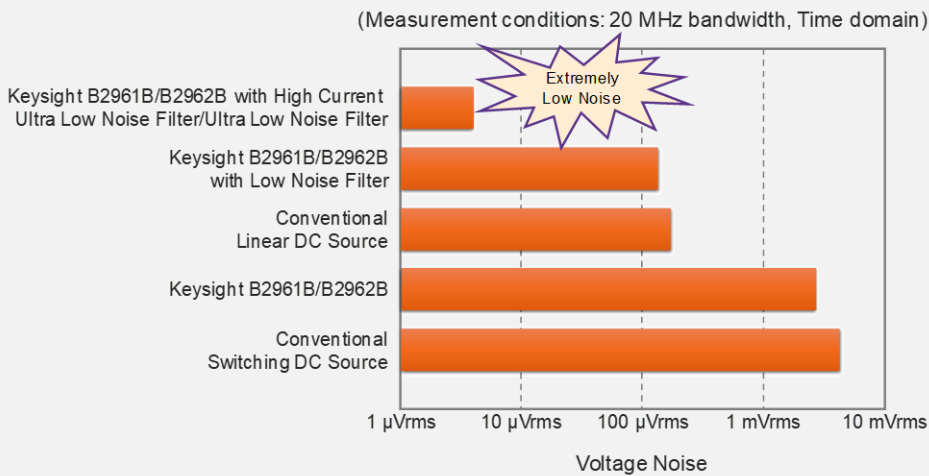

Figure 5. HC-ULNF and ULNF dramatically reduce output noise



## LNF supports full 210 V and 3 A bipolar output range

The LNF supports the B2961B/B2962B's wide bipolar voltage and current ranges (up to 210 V/3 A) while providing noise levels comparable to those of linear power supplies. In addition, when using the LNF you can still make 4-wire (Kelvin) measurements to eliminate residual cable resistance effects. For applications requiring a moderate level of low-noise performance, the LNF provides a cost-effective means to achieve low-noise sourcing capability for a modest price.

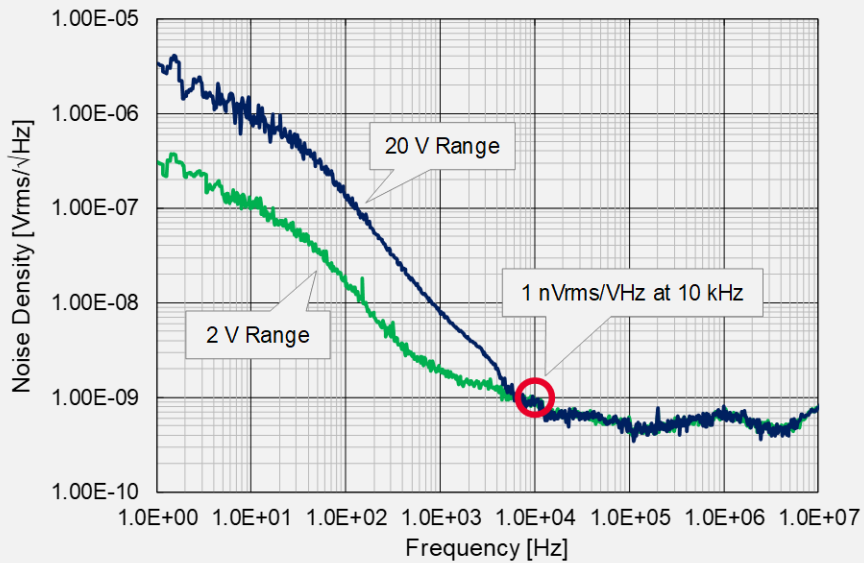

Figure 6. HC-ULNF and ULNF provide excellent noise density performance

## Intuitive Front-Panel GUI and Wide 4.3" Color LCD Maximize Test and Debug Efficiency

Many power supplies and sources only possess a numerical display or a very basic dot matrix display, which are only effective at showing DC values. In contrast, the B2961B/B2962B has an easy-to-use front panel GUI and a wide 4.3" color LCD. These make it easy to set up sourcing parameters and to display complex current and voltage waveforms. For added convenience, the B2961B/B2962B provides multiple viewing modes: single view, dual view (B2962B only) and graph view. These capabilities not only increase test and evaluation efficiency, but they also make the instrument easy to use without the need to struggle through paper manuals. See Figure 7.

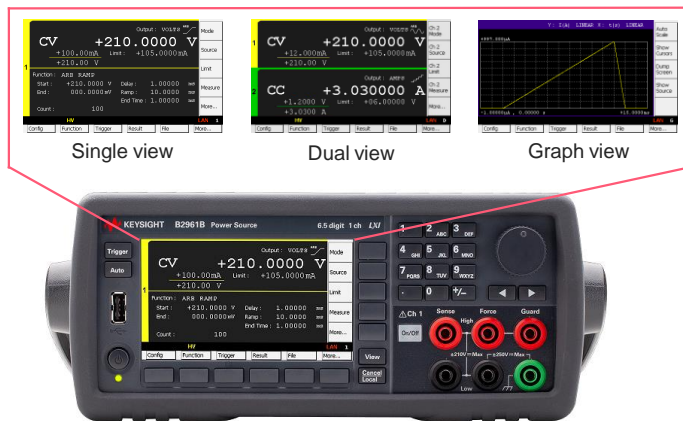

Figure 7. Three viewing modes provide you with flexible and efficient testing

## Integrated voltage and current monitoring capability verify output with 4.5 digit resolution

The B2961B/B2962B has a built-in voltage and current monitoring feature that enables you to verify the actual voltage and current output. You can view the sourced voltage and current values with 4.5 digit numeric resolution in both single and dual viewing modes. With minimum voltage and current measurement resolution of 10  $\mu$ V and 1 pA (respectively), a digital multi-meter (DMM) is not necessary for measurement verification.

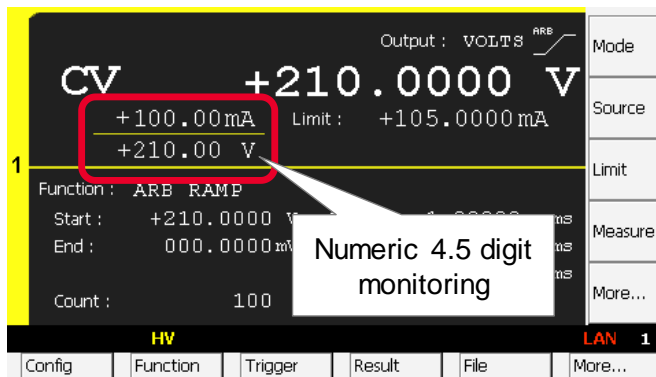

Figure 8. Perform quick status checks with 4.5 digit numeric display

## Time domain waveform viewer facilitates quick check and debug of output waveforms

In addition to the numeric monitoring, the B2961B/B2962B Power Source has a time domain waveform viewing capability (Figure 9). For most power supplies and sources, you cannot view the actual waveform you are applying to your device or sample without using some other sort of external instrument. The B2961B/B2962B's time domain monitoring capability displays applied waveforms on its LCD display (Graph View mode), enabling you to verify that you are applying the correct signal to your DUT.

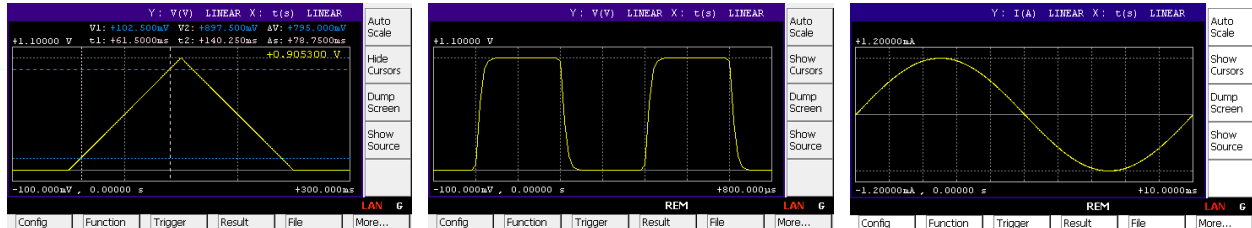

Figure 9. Graph View allows you to view output waveform in the time domain

## GUI Based Intuitive Front Panel Design with Rich Standard Interfaces for Your Bench-Top Needs

In addition to the graphical user interface and easy-to-use front panel, the B2961B/B2962B integrates standard interfaces such as USB 2.0, LAN (LXI class C compliant), digital I/O and GPIB in a bench-top instrument form. The optional filters are well designed for the B2961B/B2962B and easy to attach and detach to/from front/rear channels.



Figure 10. Front/rear panel at a glance

## Flexible Source Functions Beyond a DC Instrument Remove Your Test Restrictions

### Pre-defined and arbitrary waveforms increase your test and evaluation flexibility

The B2961B/B2962B features full-fledged test and evaluation beyond conventional static DC testing. The pre-defined waveform generation capability provides six waveforms: sinusoidal, exponential, ramp, triangle, square and trapezoidal. In addition to these commonly used waveforms, you can set user-defined arbitrary waveforms with up to 100,000 points of setting. These flexible output capabilities should help you make deeper evaluation of your devices/samples that you've tested with other instruments than power supplies and sources.

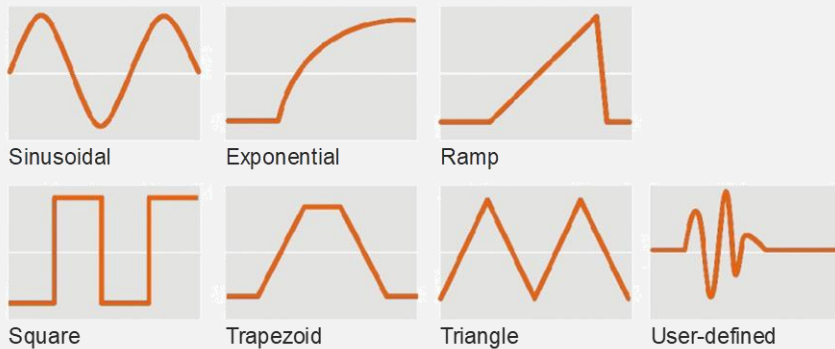

Figure 11. Convenient built-in waveform generation capabilities

### Precision and wide voltage/current waveform generation

The arbitrary waveform generation capability of B2961B/B2962B can generate both precision voltage and current waveforms in 1 MHz –10 kHz frequency range. Although some of conventional voltage/current source instruments feature a waveform generation capability, the output waveforms do not have enough accuracy as shown in Figure 12A. In contrast, as shown in Figure 12B, The B2961B/B2962B can generate cleaner and more precision waveforms for more sensitive device/sample testing. You can also make use of the same output voltage/current ranges (210 V/3 A) and the same resolutions (100 nV/10 fA) as those of original DC voltage/current specifications. This outstanding capability helps you make precision test and evaluation even in time domain.

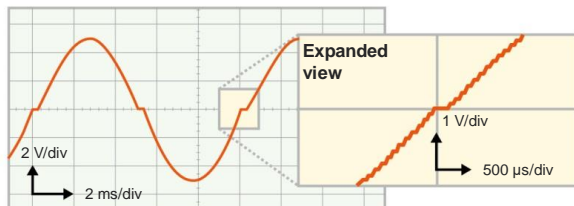

Figure 12A. Sinusoid waveform comparison at 100 Hz (Conventional voltage source)

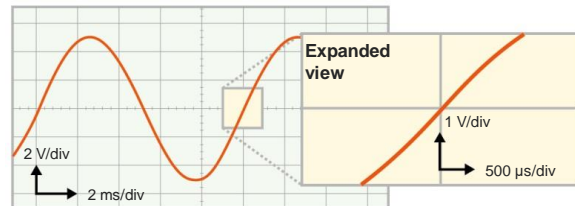

Figure 12B. Sinusoid waveform comparison at 100 Hz (B2961B/B2962B)

## Preview of output waveform and simple user interface helps quick and reliable test

The B2961B/B2962B provides convenient and user-friendly interface for this arbitrary waveform generation capabilities. The preview mode shows the waveform shape on the same display that you set the waveform parameters, and enables you to check the forcing waveform shape in advance. This well-considered user interface provides you with an intuitive test environment, and improves your test and evaluation efficiency.



Figure 13. The preview of waveform you have just set

## Programmable Output Resistance and DC Voltage/Current Output Emulation Capabilities Solve Real-World Measurement Challenges

The B2961B/B2962B's programmable output resistance function provides flexible measurement capabilities

The B2961B/B2962B has a programmable output resistance feature that allows you to control the output behavior of the power source. It supports two test modes, constant and V/I emulation, to provide maximum flexibility and versatility. Constant mode allows you to specify an output resistance value (either positive or negative) such that the output will respond exactly as if the specified resistance value were in series (voltage source mode) or in parallel (current source mode) with the source output. The constant mode can emulate resistance values over a wide range, and the negative resistance capability is particularly useful for cancelling out unwanted external resistances. For example, you can use the negative resistance feature to eliminate the resistance of long connection wires without the need to use a 4-wire (Kelvin) connection scheme. This is especially useful in situations where a 4-wire measurement is not possible due to packaged device limitations or to the absence of sense pads for probing.

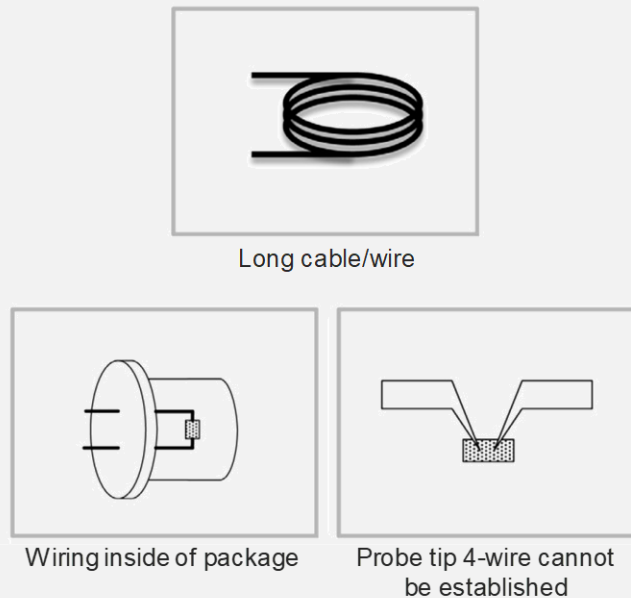

Figure 14. Measurement situations that benefit from Programmable Output Resistance's Constant mode feature

## DC voltage/current characteristic emulation feature provides powerful bench-top analysis capabilities

The programmable output resistance's V/I emulation mode function allows you to simulate any DC voltage/current output characteristic. You can specify up to 16 voltage and current points to create the desired DC electrical characteristic. Since in this mode The B2961B/B2962B responds exactly like the equivalent device or sample, it is useful for simulating electrical behavior when an actual component is not available as well as for testing corner cases. In the example shown in Figure 15, the output of an active device (solar cell) is simulated using the V/I emulation mode function. This ability to simulate both active and passive devices provides unprecedented power and flexibility in a compact bench-top form factor. (Figure 16).

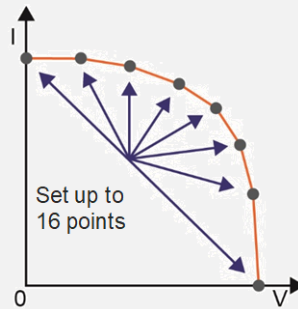

Figure 15. In V/I emulation mode you can specify up to 16 voltage/ current points to synthesize a desired electrical characteristic

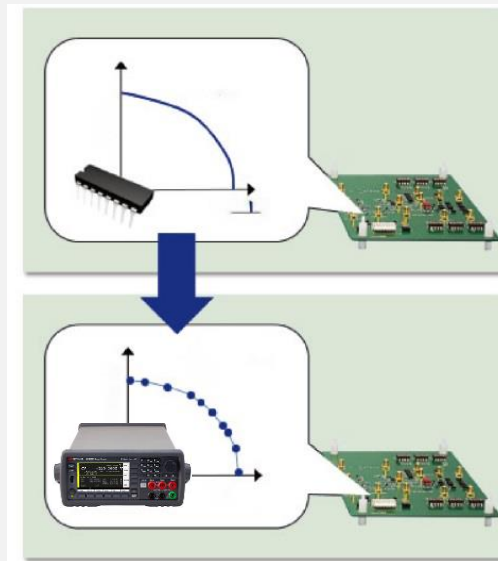

Figure 16. The B2961B/B2962B can emulate the DC voltage/current output characteristics of many devices and samples

# Multiple Communication Methods and Software Provide Flexible and Convenient Remote Control Options

## Pathwave BenchVue

Pathwave BenchVue allows you to control The B2961B/B2962B as voltage/current sources from a PC without the need to do any programming. In addition, because Pathwave BenchVue supports a wide variety of Keysight instruments (oscilloscopes, meters, etc.) it is a good choice when you need to integrate together many different types of instruments on a benchtop.



## Graphical Web Interface

The B2961B/B2962B has a built-in web server that allows it to be controlled using a web browser. This allows you to enjoy the convenience of external PC control without the need for any special software. Simply connect your computer to the instrument via its LAN port, type in the IP address of The B2961B/B2962B unit and begin making interactive tests.

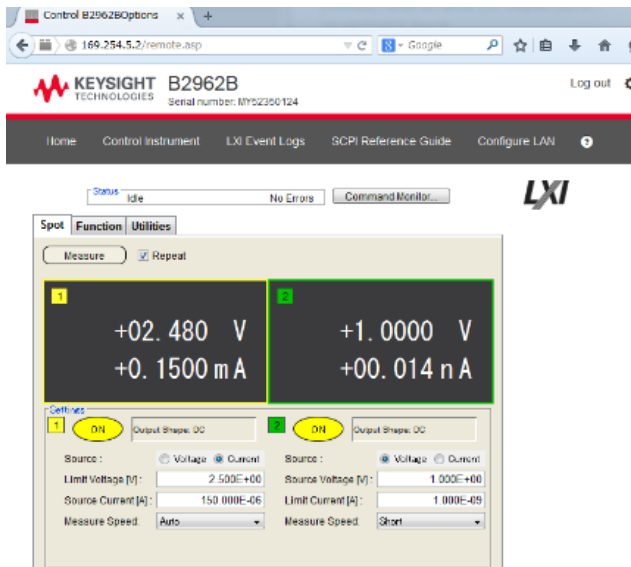



## PW9251A PathWave IV Curve Software

The PW9251A PathWave IV Curve is a ready-made GUI software to perform a variety of synchronous current-voltage (IV) measurements without programming. Various analysis function on graphs and tables allow users to review test results immediately after the measurement. Export functions of graphs with markers and tables support efficient reporting. In addition, the test result files contains all the settings, allowing users to accurately review and repeat the test. The PW9251A PathWave IV Curve accelerates your research, development and design verification with increasing productivity, enabling more accurate and reliable data acquisition, and more efficient use of the equipment.

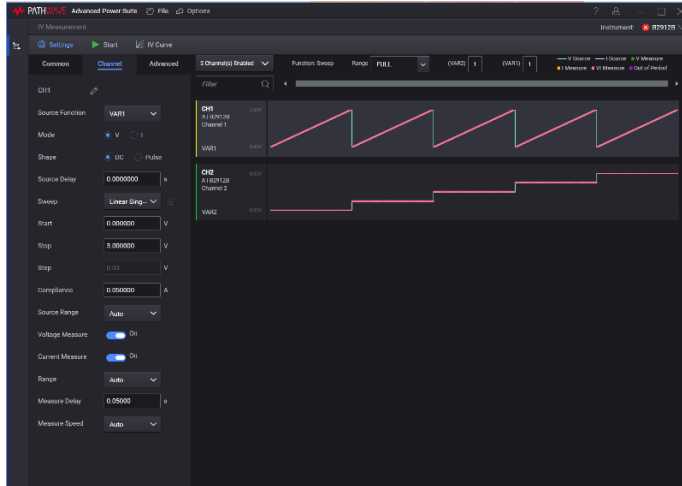

## Ready-to-use instrument drivers simplify Programming

For users that want to create their own customized software, IVI-C and IVI-COM drivers for The B2961B/B2962B are available. In addition, National Instruments LabView drivers are available at [NI.COM](http://NI.COM).

## Key Specifications

		B2961B/ B2962B	B2961B/B2962B with High Current Ultra Low Noise Filter	B2961B/B2962B with Ultra Low Noise Filter	B2961B/B2962B with Low Noise Filter	
Number of channel		1 or 2	1 or 2	1 or 2	1 or 2	
Output	DC or arbitrary waveform output	Max. voltage	± 210 V	± 21 V	± 42 V	± 210 V
		Max. current	± 3.03 A	± 500 mA	± 105 mA	± 3.03 A
	Pulsed	Max. voltage	± 200 V	± 21 V	± 42 V	± 200 V
		Max. current	± 10.5 A	± 500 mA	± 105 mA	± 3.03 A <sup>4</sup>
	Maximum power	31.8 W	10.5 W	4.4 W	31.8 W	
Output polarity		Bipolar (4-quadrant operation)				
Source resolution	Digit	6.5 digit	6.5 digit	6.5 digit	6.5 digit	
	Minimum resolution	100 nV /10 fA	100 nV /10 pA	100 nV /10 pA	100 nV /10 pA	
Output capability	DC	Yes	Yes	Yes	Yes	
	Pulsed	Yes	Only voltage output	Only voltage output	Only voltage output	
	Sweep DC/Pulse/List	Yes	Only voltage output	Only voltage output	Only voltage output	
	Arbitrary wave form	Yes	Only voltage output	Only voltage output	Only voltage output	
Noise <sup>1</sup>	0.1 to 10 Hz	≤ 5 μVpp	≤ 5 μVpp	≤ 5 μVpp	≤ 5 μVpp	
	10 to 20 MHz	3 mVrms	10 μVrms (1 nVrms/√Hz @ 10 kHz)	10 μVrms (1 nVrms/√Hz @ 10 kHz)	350 μVrms	
Measurement capability		4.5 digit built-in voltage/current monitor				
Source/ monitor ranges	Voltage	200 mV to 200 V	200 mV to 20 V <sup>2</sup>	200 mV to 200 V <sup>3</sup>	200 mV to 200 V	
	Current	10 nA to 10 A	1 mA to 1 A	10 μA to 100 mA	10 μA to 3 A	
Programmable output resistance	Constant R	Yes	No	No	No	
	V/I emulation	Yes	No	No	No	
View mode	Single view	Yes	Yes	Yes	Yes	
	Waveform preview	Yes	Yes	Yes	Yes	
	Dual View	Only 2 ch model (B2962B)				
	Graph view (time-domain voltage/current waveform viewer)	Yes	Yes	Yes	Yes	
Max capacitive load		0.01 μF (normal mode)	50 μF	50 μF	1 mF	
Interface		GPIO, USB 2.0, LAN and digital I/O(LXI Core Conformant)				

1. Supplemental characteristics.
2. Maximum voltage output is limited to 21 V for 20 V range.
3. Maximum voltage output is limited to 42 V for 200 V range.
4. 10 A pulse range is not supported.

# Specifications

## Specification conditions

Temperature	23 °C ± 5 °C
Humidity	30% to 80% RH
After 60 minutes warm-up	Ambient temperature change less than ± 3 °C after self-calibration execution
Calibration period	1 year
Measurement speed	1 PLC (power line cycle)

## Maximum voltage and current

	Max voltage	Max current
DC or pulsed <sup>1</sup>	210 V	0.105 A
	21 V	1.515 A <sup>2</sup>
	6 V	3.03 A <sup>2</sup>
Pulsed only <sup>1</sup>	200 V	1.515 A
	6 V	10.5 A

1. See "Maximum pulse width and duty cycle" in Pulse Source Supplemental Characteristics for applicable maximum voltage and current.
2. Max current limitation: For 21 V/1.515 A and 6 V/3.03 A ranges, total max current is limited by the table below for using 2 channels. Max current is not limited for using 1 channel only.

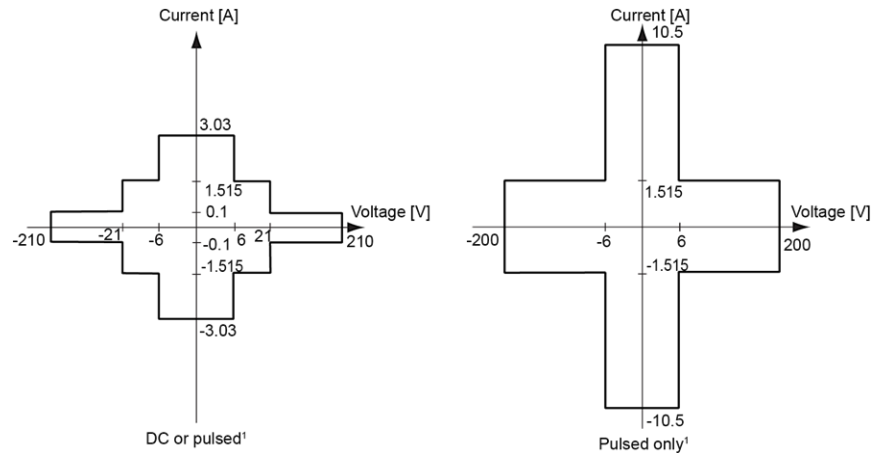

## Maximum current limitation

Ch1 voltage	Ch2 voltage	Max total current limitation of Ch1 and Ch2
± (0 V < V ≤ 6 V)	± (0 V < V ≤ 6 V)	Ch1 current + Ch2 current ≤ 4 A
± (0 V < V ≤ 6 V)	± (6 V < V ≤ 21 V)	Ch1 current + Ch2 current x 1.6 ≤ 4 A
± (6 V < V ≤ 21 V)	± (0 V < V ≤ 6 V)	Ch1 current + Ch2 current x 0.625 ≤ 2.5 A
± (6 V < V ≤ 21 V)	± (6 V < V ≤ 21 V)	Ch1 current + Ch2 current ≤ 2.5 A

## DC voltage source specifications

Range	Programming resolution	Accuracy $\pm$ (% reading + offset)	Noise (peak to peak) 0.1 Hz to 10 Hz <sup>1</sup>	Max voltage (over range)
$\pm 200$ mV	100 nV	$\pm (0.015 \% + 225 \mu\text{V})$	$\leq 5 \mu\text{V}$	$\pm 210$ mV
$\pm 2$ V	1 $\mu\text{V}$	$\pm (0.02 \% + 350 \mu\text{V})$	$\leq 15 \mu\text{V}$	$\pm 2.1$ V
$\pm 20$ V	10 $\mu\text{V}$	$\pm (0.015 \% + 5 \text{ mV})$	$\leq 150 \mu\text{V}$	$\pm 21$ V
$\pm 200$ V	100 $\mu\text{V}$	$\pm (0.015 \% + 50 \text{ mV})$	$\leq 1.5 \text{ mV}$	$\pm 210$ V

1. Supplemental characteristics.

## DC current source specification

Range	Programming resolution	Accuracy $\pm$ (% reading + offset)	Noise (peak to peak) 0.1 Hz to 10 Hz <sup>1</sup>	Max voltage (over range)
$\pm 10$ nA	10 fA	$\pm (0.10 \% + 50 \text{ pA})$	$\leq 1 \text{ pA}$	$\pm 10.5$ nA
$\pm 100$ nA	100 fA	$\pm (0.06 \% + 100 \text{ pA})$	$\leq 2 \text{ pA}$	$\pm 105$ nA
$\pm 1$ $\mu\text{A}$	1 pA	$\pm (0.025 \% + 500 \text{ pA})$	$\leq 20 \text{ pA}$	$\pm 1.05$ $\mu\text{A}$
$\pm 10$ $\mu\text{A}$	10 pA	$\pm (0.025 \% + 1.5 \text{ nA})$	$\leq 60 \text{ pA}$	$\pm 10.5$ $\mu\text{A}$
$\pm 100$ $\mu\text{A}$	100 pA	$\pm (0.02 \% + 25 \text{ nA})$	$\leq 1 \text{ nA}$	$\pm 105$ $\mu\text{A}$
$\pm 1$ mA	1 nA	$\pm (0.02 \% + 200 \text{ nA})$	$\leq 6 \text{ nA}$	$\pm 1.05$ mA
$\pm 10$ mA	10 nA	$\pm (0.02 \% + 2.5 \mu\text{A})$	$\leq 100 \text{ nA}$	$\pm 10.5$ mA
$\pm 100$ mA	100 nA	$\pm (0.02 \% + 20 \mu\text{A})$	$\leq 600 \text{ nA}$	$\pm 105$ mA
$\pm 1$ A	1 $\mu\text{A}$	$\pm (0.03 \% + 1.5 \text{ mA})$	$\leq 20 \mu\text{A}$	$\pm 1.05$ A
$\pm 1.5$ A	1 $\mu\text{A}$	$\pm (0.05 \% + 3.5 \text{ mA})$	$\leq 20 \mu\text{A}$	$\pm 1.515$ A
$\pm 3$ A	10 $\mu\text{A}$	$\pm (0.4 \% + 7 \text{ mA})$	$\leq 60 \mu\text{A}$	$\pm 3.03$ A
$\pm 10$ A <sup>2</sup>	10 $\mu\text{A}$	$\pm (0.4 \% + 25 \text{ mA})$ <sup>3</sup>		$\pm 10.5$ A

1. Supplemental characteristics.

2. 10 A range is available only for pulse mode, not available for DC mode.

3. Measurement speed: 0.01 PLC.

## Source Supplemental Characteristics

### Pulsing capabilities

Minimum programmable pulse width	50 $\mu$ s
Pulse width programming resolution	1 $\mu$ s
Pulse width definition	The time from 10 % leading to 90 % trailing edge as follows

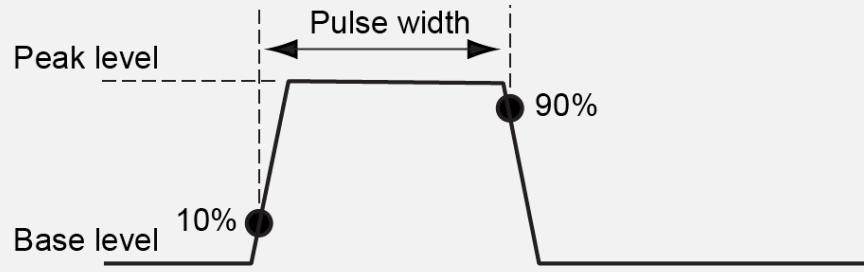

### Maximum pulse width and duty cycle

	Pulsed					DC	
	Max voltage	Max peak current	Max base current	Pulse width	Max duty cycle	Max voltage	Max current
DC or pulsed	210 V	0.105 A	0.105 A	50 $\mu$ s to 99999.9 s	99.9999 %	210 V	0.105 A
	21 V	1.515 A <sup>1</sup>	1.515 A <sup>1</sup>	50 $\mu$ s to 99999.9 s	99.9999 %	21 V	1.515 A <sup>1</sup>
	6 V	3.03A <sup>1</sup>	3.03 A <sup>1</sup>	50 $\mu$ s to 99999.9 s	99.9999 %	6 V	3.03 A <sup>1</sup>
Pulsed only	200 V	1.515A	50 mA	50 $\mu$ s to 2.5 ms	2.5 %		
	180 V	1.05 A	50 mA	50 $\mu$ s to 10 ms	2.5 %		
	6 V	5.25 A	0.1 A	50 $\mu$ s to 3 ms	3.0 %		
	6 V	10.5 A	0.5 A	50 $\mu$ s to 1 ms	2.5 %		

1. Max current limitation: For 21 V/1.515 A and 6 V/3.03 A ranges, total max current is limited by the table in page 19 for using 2 channels. Max current is not limited for using 1 channel only.

### Minimum pulse width at the given voltage, current and settling conditions

Source value	Limit value	Load	Source settling (% of range)	Min pulse width
200 V	1.5 A	200 $\Omega$	0.1%	1 ms
6 V	10.5 A	0.6 $\Omega$	0.1%	0.2 ms
1.5 A	200 V	65 $\Omega$	0.1%	2.5 ms
10.5 A	6 V	0.5 $\Omega$	0.1%	0.2 ms
10.5 A <sup>1</sup>	6 V <sup>1</sup>	0.1 $\Omega$ <sup>1</sup>	0.1 % <sup>1</sup>	0.1 ms <sup>1</sup>

1. Transient speed mode is set to FAST.

## Sweep capabilities

Sweep mode	Linear, logarithmic (log) or list
Sweep direction	Single or double
Type	DC, or pulse
Number of steps	1 to 100,000
Min programmable value to create list sweep waveform	Minimum 10 $\mu$ s with 1 $\mu$ s resolution

## Arbitrary Waveform Generation Capabilities

Pre-defined waveforms	
Supported waveforms	Sine, Square, Ramp, Triangle, Trapezoid and Exponential
Frequency	1 mHz to 10 kHz
Programmable frequency/timing resolution	1 $\mu$ Hz nominal (sine), 250 ns (waveforms other than sine)
Frequency accuracy of time base	$\pm$ 50 ppm
Linearity (best-fit)	Voltage Source $\pm$ 0.01% <sup>1</sup> , Current Source $\pm$ 0.01% <sup>2</sup>
THD	Voltage Source -90 dB <sup>3</sup> , Current Source -90 dB <sup>4</sup>

1.  $\pm$  1 V,  $\pm$  10 V,  $\pm$  200 V, open load.

2.  $\pm$  10 mA 1 k $\Omega$  load,  $\pm$  100 mA 100  $\Omega$  load.

3.  $\pm$  1 V,  $\pm$  10 V,  $\pm$  180 V, open load.

4.  $\pm$  1  $\mu$ A 100 k $\Omega$  load,  $\pm$  10  $\mu$ A 100 k $\Omega$  load,  $\pm$  10 mA 100  $\Omega$  load.

User-defined waveforms	
Waveform length	1 to 100,000 points
Sample rate	0.001 to 100,000 Sa/s, 250 ns resolution
Storage	Non-volatile memory and USB memory are both available. Non-volatile memory can store one waveform with a length of up to 2500 points. USB memory can store waveforms of up to 100k points.

## Output characteristics

Temperature coefficient (0 to 18 °C and 28 °C to 50 °C)	$\pm (0.1 \times \text{Accuracy})/^{\circ}\text{C}$
Max output power and source/sink limits	31.8 W
	$\pm 6 \text{ V}@ \pm 3.03 \text{ A}$ , $\pm 21 \text{ V}@ \pm 1.515 \text{ A}$ , $\pm 210 \text{ V}@ 105 \text{ mA}$ , four quadrant source or sink operation
Output location	Channel 1 at front, and channel 2 at rear
Output connectors	Banana jack. Triaxial connections are recommended for sourcing less than 1 nA. A banana jack to triaxial adapter is available for low current source.
Low terminal connection	Chassis grounded or floating
Sensing Modes	2-wire or 4-wire (Remote-sensing) connections
Maximum load	Normal mode: 0.01 $\mu\text{F}$
	High capacitance mode: 50 $\mu\text{F}$
DC floating voltage	Max $\pm 250 \text{ V DC}$ between low force and chassis ground
Guard offset voltage (V source)	< 4 mV
Remote sense operation range	Max voltage between High Force and High Sense = 3 V
	Max voltage between Low Force and Low Sense = 3 V
Common mode isolation	> 1 G $\Omega$ , < 4500 pF
Max sense lead resistance	1 k $\Omega$ for rated accuracy
Sense input impedance	> 10 G $\Omega$
Current limit/compliance	Accuracy is same as current source. Min value is 1 % of range, or 1 nA in 10 nA range.
Voltage limit/compliance	Accuracy is same as voltage source. Min value is 1 % of range, or 20 mV in 200 mV range.
Over range	101 % of source range for 1.5 A and 3 A ranges. 105 % of source range other than 1.5 A and 3 A ranges. No over range for 200 V range with current exceeding 105 mA pulse only condition.
Over temperature protection	Output turns off then resets at over temperature sensed internally

## Voltage source

Settling time	Time required to reach within 0.1 % of final value at open load condition. Step is 10 % to 90 % range		
	200 mV, 2 V ranges	< 50 $\mu$ s	
	20 V range	< 110 $\mu$ s	
	200 V range	< 70 $\mu$ s	
Noise 10 Hz to 20 MHz	< 3 mVrms, 20 V range, without external filter		
V source overshoot	< $\pm$ (0.1 % + 10 mV). Step is 10 % to 90 % range, resistive load		
Voltage source range change overshoot	$\leq$ 250 mV. 100 k $\Omega$ load, 20 MHz bandwidth		
Line regulation/load regulation	Included in voltage source specifications		
Load transient recovery time	Time to recover to within the settling band following a load change.		
	Current change	100 mA <sup>1</sup>	800 mA <sup>2</sup>
	Settling band	$\pm$ 20 mV	$\pm$ 20 mV
	Time	10 $\mu$ s	30 $\mu$ s

1. At a load change to change the flowing current from +50 mA to +150 mA, 10 V voltage force, 20 V range, 1 A limit.

2. At a load change to change the flowing current from +100 mA to +900 mA, 10 V voltage force, 20 V range, 1.5 A limit.

Slew rate/small signal bandwidth					
Current range	Voltage range				Load resistance
	200 mV	2 V	20 V	200 V	
1 mA	44 mV/ $\mu$ s, 28 kHz	57 mV/ $\mu$ s, 18 kHz	57 mV/ $\mu$ s, 28 kHz	57 mV/ $\mu$ s, 28 kHz	10 M $\Omega$
10 mA	44 mV/ $\mu$ s, 28 kHz	360 mV/ $\mu$ s, 20 kHz	360 mV/ $\mu$ s, 17 kHz	360 mV/ $\mu$ s, 28 kHz	10 M $\Omega$
100 mA	28 mV/ $\mu$ s, 28 kHz	28 mV/ $\mu$ s, 20 kHz	28 mV/ $\mu$ s, 28 kHz	57 mV/ $\mu$ s, 28 kHz	10 M $\Omega$
1 A	25 mV/ $\mu$ s, 28 kHz	25 mV/ $\mu$ s, 28 kHz	25 mV/ $\mu$ s, 28 kHz		10 M $\Omega$
1.5 A	36 mV/ $\mu$ s, 28 kHz	36 mV/ $\mu$ s, 18 kHz	36 mV/ $\mu$ s, 28 kHz		10 M $\Omega$
3 A	27 mV/ $\mu$ s, 28 kHz	27 mV/ $\mu$ s, 28 kHz	27 mV/ $\mu$ s, 28 kHz		10 M $\Omega$

Note: Slew rate and small signal bandwidth can be down to -20% in maximum.



## Current source

Settling time	Time required to reach within 0.1 % of final value at open load condition. Step is 10 % to 90 % range	
	10 nA, 100 nA ranges	< 10 ms
	1 $\mu$ A range	< 500 $\mu$ s
	10 $\mu$ A, 100 $\mu$ A ranges	< 250 $\mu$ s
	1 mA to 3 A ranges	< 80 $\mu$ s
I source overshoot	< $\pm$ 0.1 % (< $\pm$ 0.3 % for 3 A range). Step is 10 % to 90 % range, resistive load	
Current source range change overshoot	$\leq$ 250 mV/R load, 20 MHz bandwidth	
Line regulation/load regulation	Included in current source specifications.	

Slew rate/small signal bandwidth					
Current range	Voltage range				Load resistance
	200 mV	2 V	20 V	200 V	
1 mA	94 $\mu$ A/ $\mu$ s, 21 kHz	160 $\mu$ A/ $\mu$ s, 21 kHz	160 $\mu$ A/ $\mu$ s, 21 kHz	150 $\mu$ A/ $\mu$ s, 21 kHz	100 $\Omega$
10 mA	94 $\mu$ A/ $\mu$ s, 21 kHz	670 $\mu$ A/ $\mu$ s, 21 kHz	900 $\mu$ A/ $\mu$ s, 21 kHz	900 $\mu$ A/ $\mu$ s, 21 kHz	100 $\Omega$
100 mA	8 mA/ $\mu$ s, 10 kHz	8 mA/ $\mu$ s, 10 kHz	8 mA/ $\mu$ s, 10 kHz	12 mA/ $\mu$ s, 21 kHz	1 $\Omega$
1 A	78 mA/ $\mu$ s, 12 kHz	94 mA/ $\mu$ s, 12 kHz	92 mA/ $\mu$ s, 12 kHz		0.1 $\Omega$
1.5 A	125 mA/ $\mu$ s, 12 kHz	135 mA/ $\mu$ s, 12 kHz	140 mA/ $\mu$ s, 12 kHz		0.1 $\Omega$
3 A	250 mA/ $\mu$ s, 13 kHz	270 mA/ $\mu$ s, 13 kHz	260 mA/ $\mu$ s, 13 kHz		0.041 $\Omega$

Note: Slew rate and small signal bandwidth can be down to -20% in maximum.

## High capacitance mode

The high capacitance mode supports sources and measurements when the load capacitance is greater than 0.01  $\mu\text{F}$ . In high capacitance mode the maximum allowed load capacitance value is 50  $\mu\text{F}$ .

Voltage output settling time		Time required to reach within 0.1 % of final value with 4.7 $\mu\text{F}$ capacitive load on a fixed range at specified current range and limit value	
		200 mV, 2 V ranges	600 $\mu\text{s}$ , at 1 A limit
		20 V range	1.5 ms, at 1 A limit
		200 V range	20 ms, at 100 mA limit
Current measurement settling time		Time required to reach 0.1 % of final value after the voltage source stabilized in a fixed range. $V_{\text{out}}$ is 5 V unless noted.	
		1 $\mu\text{A}$ range	230 ms
		10 $\mu\text{A}$ , 100 $\mu\text{A}$ ranges	23 ms
		1 mA, 10 mA ranges	0.23 ms
		100 mA to 3 A ranges	100 $\mu\text{s}$
Mode change delay	Delay into high cap mode	1 $\mu\text{A}$ range	230 ms
		10 $\mu\text{A}$ , 100 $\mu\text{A}$ ranges	23 ms
		1 mA to 3 A ranges	1 ms
	Delay out of high cap mode	All ranges	10 ms
Noise 10 Hz to 20 MHz (20 V range)		4.5 mVrms	
Voltage source range change overshoot (20 V range or below)		< 250 mV, 20 MHz bandwidth	
High capacitance mode working conditions		V/I mode	Voltage source mode only
		Range	Current measurement range is limited to fixed range only. 10 nA and 100 nA ranges are not available.
Current limit		$\geq 1 \mu\text{A}$	

## Programmable output resistance <sup>1</sup>

In its default state The B2961B/B2962B behaves like either an ideal voltage source with a negligibly small source resistance or an ideal current source with a huge source resistance. The programmable output resistance feature allows you to specify either a particular output resistance or a specific voltage versus current source characteristic. This feature is ideal for emulating a wide variety of devices (such as batteries, photovoltaic cells, sensors, transducers, etc.) that are otherwise difficult to simulate. Emulation mode allows you to program a non-linear resistance. You specify the desired voltage/current characteristic using a tabular format.

Mode		Constant or V/I Emulation
Programmable resistance range in Constant mode	Series resistance (Rs) at voltage source	- $(\text{Load Resistance}/2) \leq R_s \leq \text{Load Resistance}$ , for resistive load
		$R_s \leq 25 \Omega$ at 3 A range, $\leq 100 \Omega$ at 1 A and 1.5 A ranges, $\leq 1 \text{ k}\Omega$ at 100 mA range, or $\leq 10 \text{ k}\Omega$ at other ranges
		Rs can be limited by capacitive load
	Shunt resistance (Rsh) at current source	Load Resistance $\leq R_{sh} \leq 2 \text{ G}\Omega$ , for resistive load
		$R_{sh} \geq 10 \text{ M}\Omega$ at 10 nA and 100 nA ranges, $\geq 1 \text{ M}\Omega$ at other ranges
		Rsh can be limited by capacitive load
Max number of points in Emulation mode		16 (piecewise linear interpolation between points)

1. Programmable output resistance is only available for DC output.

## External low noise filter supplemental characteristics

The B2961B/B2962B supports dedicated external low-noise filters; they are available as an option or as an accessory. They connect to the banana jack outputs of each B2961B/B2962B channel.

### High Current Ultra Low Noise Filter (N1298A)

Maximum output range		21 V / 500 mA (DC)	
Output connector		BNC	
Output/residual resistance		10 $\Omega$ nominal (2-wire), 0.3 $\Omega$ nominal (4-wire. 4-wire connected inside of filter)	
Small signal bandwidth		23 Hz nominal (2-wire), 8 Hz nominal (4-wire)	
Source noise	Voltage	0.1 to 10 Hz	Same as voltage specification
		10 to 20 MHz	10 $\mu$ Vrms, 1nVrms $\sqrt{\text{Hz}}$ at 10 kHz (20 V / 100 mA range, 50 $\Omega$ load)
	Current	0.1 to 10 Hz:	Same as current specification
		10 to 1 MHz	8 $\mu$ Arms (20 V/1 A range, 2 $\Omega$ load)
Source setting time	Voltage <sup>1</sup>	80 ms (2-wire), 140 ms (4-wire)	
	Current <sup>2</sup>	11 ms (2-wire), 150 ms (4-wire)	
Load transient recovery time	Time to recover to within the settling band following a load change.		
	Current change	250 mA <sup>3</sup>	
	Settling band	$\pm$ 20 mV	
	Time	50 ms (2-wire), 85 ms (4-wire)	
Supported ranges	Voltage	200 mV to 200 V ranges (21 V maximum)	
	Current	1 mA to 1 A ranges (500 mA maximum)	
Maximum capacitive load		50 $\mu$ F (for 4-wire)	
Dimensions		41 mm H x 58.2 mm W x 141.5 mm D (When the filter is inserted to the output connector of B2961B/B2962B, the depth is 126.5 mm.)	
Weight		0.3 kg	

1. Time required to reach within 0.1 % of final value at open load condition. Step is 10 % to 90 % range. At 20 V range, 500 mA limit/1 A range.
2. Time required to reach within 0.1 % of final value at short condition. Step is 10 % to 90 % range. At 500 mA (1 A) range, 20 V limit/20V range.
3. At a load change to change the flowing current from +10 mA to +260 mA, 10 V voltage force, 20 V range, 500 mA limit.

Note:

- The 10 A pulse range and programmable output resistance capability are not supported by external filters.
- For the current output, only DC is supported when using with external filters.
- The current measurement data monitored by the built-in voltage/current monitor can be influenced by the charge and discharge current of the capacitance inside of the filters.

## Ultra Low Noise Filter (N1298B)

Maximum output range		42 V / 105 mA (DC)	
Output connector		BNC	
Output/residual resistance		50 $\Omega$ nominal (2-wire), 0.3 $\Omega$ nominal (4-wire. 4-wire connected inside of filter)	
Small signal bandwidth		23 Hz nominal (2-wire), 8 Hz nominal (4-wire)	
Source noise	Voltage	0.1 to 10 Hz	Same as voltage specification
		10 to 20 MHz	10 $\mu$ Vrms, 1 nVrms $\sqrt{\text{Hz}}$ at 10 kHz (20 V / 100 mA range, 50 $\Omega$ load)
	Current	0.1 to 10 Hz:	Same as current specification
		10 to 1 MHz	300 nArms (20 V/100 mA range, 10 $\Omega$ load)
Source setting time	Voltage <sup>1</sup>	80 ms (2-wire), 140 ms (4-wire)	
	Current <sup>2</sup>	11 ms (2-wire), 150 ms (4-wire)	
Load transient recovery time	Time to recover to within the settling band following a load change.		
	Current change	50 mA <sup>3</sup>	
	Settling band	$\pm$ 20 mV	
	Time	50 ms (2-wire), 85 ms (4-wire)	
Supported ranges	Voltage	200 mV to 200 V ranges (42 V max)	
	Current	10 $\mu$ A to 100 mA ranges (105 mA max)	
Maximum capacitive load		50 $\mu$ F (for 4-wire)	
Dimensions		41 mm H x 58.2 mm W x 141.5 mm D (When the filter is inserted to the output connector of B2961B/B2962B, the depth is 126.5 mm.)	
Weight		0.3 kg	

1. Time required to reach within 0.1 % of final value at open load condition. Step is 10 % to 90 % range. At 20 V range, 100 mA limit/100 mA range.
2. Time required to reach within 0.1 % of final value at short condition. Step is 10 % to 90 % range. At 100 mA range, 20 V limit/20V range.
3. At a load change to change the flowing current from +10 mA to +60 mA, 10 V voltage force, 20 V range, 100 mA limit.

### Note:

- The 10 A pulse range and programmable output resistance capability are not supported by external filters.
- For the current output, only DC is supported when using with external filters.
- The current measurement data monitored by the built-in voltage/current monitor can be influenced by the charge and discharge current of the capacitance inside of the filters.

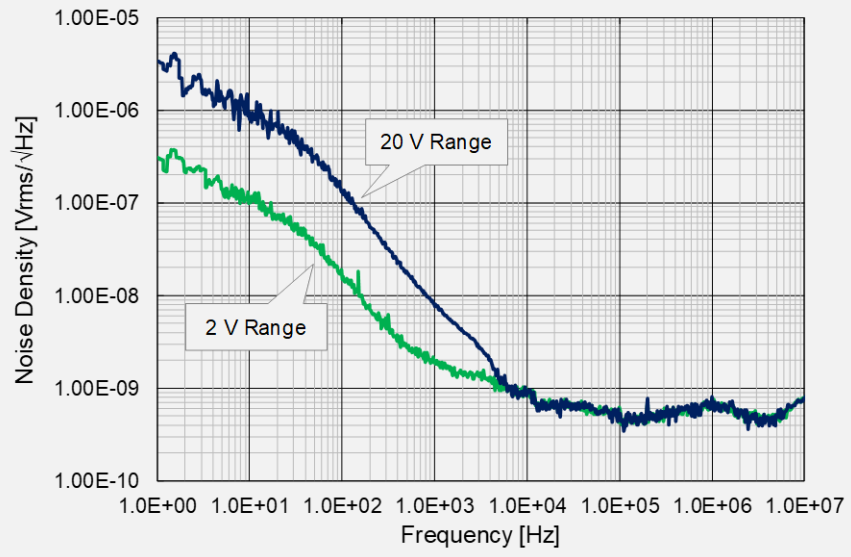

## Low Noise Filter (N1298C)

Maximum output range		210 V/3 A (DC)	
Output connector		Banana, 2-wire/4-wire	
Output/residual resistance		0.3 $\Omega$ nominal (2-wire)	
Small signal bandwidth		2 kHz nominal (1 A and 3 A ranges), 800 Hz nominal (100 mA range)	
Source noise	Voltage	0.1 to 10 Hz	Same as voltage specification
		10 to 20 MHz	350 $\mu$ Vrms (20 V/1.5 A range, 50 $\Omega$ load)
	Current	0.1 to 10 Hz:	Same as current specification
		10 to 1 MHz	450 $\mu$ Arms (20 V/1.5 A range, 0.67 $\Omega$ load)
Source setting time	Voltage <sup>1</sup>	640 $\mu$ s (2-wire/4-wire)	
	Current <sup>2</sup>	1.2 ms (2-wire/4-wire)	
Load transient recovery time	Time to recover to within the settling band following a load change.		
	Current change	800 mA <sup>3</sup>	
	Settling band	$\pm$ 20 mV	
	Time	450 $\mu$ s (2-wire), 650 $\mu$ s (4-wire)	
Supported ranges	Voltage	200 mV to 200 V ranges (210 V max)	
	Current	10 $\mu$ A to 3 A ranges (3 A max)	
Maximum capacitive load		1 mF	
Dimensions		41.5 mm H x 58.2 mm W x 127.5 mm D (When the filter is inserted to the output connector of B2961B/B2962B, the depth is 112.5 mm.)	
Weight		0.25 kg	

1. Time required to reach within 0.1 % of final value at open load condition. Step is 10 % to 90 % range. At 20 V range, 1.5 A limit/1.5 A range.
2. Time required to reach within 0.1 % of final value at short condition. Step is 10 % to 90 % range. At 1.5 A range, 20 V limit/20V range.
3. At a load change to change the flowing current from +100 mA to +900 mA, 10 V voltage force, 20 V range, 1.5 A limit.

### Note:

- The 10 A pulse range and programmable output resistance capability are not supported by external filters.
- For the current output, only DC is supported when using with external filters.
- The current measurement data monitored by the built-in voltage/current monitor can be influenced by the charge and discharge current of the capacitance inside of the filters.

## Built-in voltage/current monitor specifications

### Voltage measurement specifications

Range	Measurement resolution	Accuracy (% reading + offset)
± 200 mV	10 µV	± (0.015 % + 225 µV)
± 2 V	100 µV	± (0.02 % + 350 µV)
± 20 V	1 mV	± (0.015 % + 5 mV)
± 200 V	10 mV	± (0.015 % + 50 mV)

### Current measurement specifications

Range	Measurement resolution	Accuracy (% reading + offset)
± 10 nA	1 pA	± (0.10 % + 50 pA)
± 100 nA	10 pA	± (0.06 % + 100 pA)
± 1 µA	100 pA	± (0.025 % + 500 pA)
± 10 µA	1 nA	± (0.025 % + 1.5 nA)
± 100 µA	10 nA	± (0.02 % + 25 nA)
± 1 mA	100 nA	± (0.02 % + 200 nA)
± 10 mA	1 µA	± (0.02 % + 2.5 µA)
± 100 mA	10 µA	± (0.02 % + 20 µA)
± 1 A	100 µA	± (0.03 % + 1.5 mA)
± 1.5 A	100 µA	± (0.05 % + 3.5 mA)
± 3 A	1 mA	± (0.4 % + 7 mA)
± 10 A <sup>1</sup>	1 mA	± (0.4 % + 25 mA) <sup>2</sup>

1. 10 A range is available only for pulse mode, not available for DC mode.

2. Measurement speed: 0.01 PLC.



## Built-in voltage/current monitor supplemental characteristics

Temperature coefficient (0 to 18 °C and 28 °C to 50 °C)	$\pm (0.1 \times \text{Accuracy})/^{\circ}\text{C}$
Over range	102 % of measurement range for 1.5 A and 3 A ranges
	106 % of measurement range other than 1.5 A and 3 A ranges
Voltage measurement range change overshoot	< 250 mV. 100 k $\Omega$ load, 20 MHz bandwidth
Current measurement range change overshoot	< 250 mV/R load, 20 MHz bandwidth

Derating accuracy for measurement speed less than 1 PLC: Add % of range using the following table for measurement with PLC < 1.

	Voltage range		Current range			
	0.2 V	2 V to 200 V	10 nA	100 nA	1 $\mu\text{A}$ to 100 mA	1 A to 3 A
0.1 PLC	0.01 %	0.01 %	0.1 %	0.01 %	0.01 %	0.01 %
0.01 PLC	0.05 %	0.02 %	1 %	0.1 %	0.05 %	0.02 %
0.001 PLC	0.5 %	0.2 %	5 %	1 %	0.5 %	0.2 %

### Data buffers

100,000 points/channel

## Timer and triggering specification

Timer	Time stamp	TIMER value automatically saved when each measurement is triggered
	Trigger timing resolution	1 $\mu\text{s}$ to 100 ms
	Accuracy	$\pm 50$ ppm
	Arm/trigger delay	0 $\mu\text{s}$ to 100,000 s
	Arm/trigger interval	10 $\mu\text{s}$ to 100,000 s
	Arm/trigger event	1 to 100,000
Triggering <sup>1</sup>	Digital I/O Trigger in to trigger out	$\leq 5 \mu\text{s}$
	Digital I/O Trigger in to source change	$\leq 5 \mu\text{s}$
	LXI Trigger in to source change	Min 100 $\mu\text{s}$ , Typical 200 $\mu\text{s}$ , Max Unknown
	LXI Trigger in to measurement	Min 100 $\mu\text{s}$ , Typical 200 $\mu\text{s}$ , Max Unknown
	Internal event to external LXI trigger output	Min 100 $\mu\text{s}$ , Typical 200 $\mu\text{s}$ , Max unknown
	LXI event send/receive latency	Unknown
	Min trigger interval	10 $\mu\text{s}$

1. Supplemental characteristics.

## Environmental specifications

Environment		For use in indoor facilities
Operating		0 °C to +55 °C, 30 % to 80 % non-condensing
Storage		-30 °C to 70 °C, 10 % to 90 % non-condensing
Altitude		Operating: 0 m to 2000 m, Storage: 0 m to 4600 m
Power supply		90 V to 264 V, 47 Hz to 63 Hz, 250 VA max
Overvoltage category		II
Pollution degree		2
EMC		IEC61326-1/EN61326-1, CISPR11/EN55011 Group 1 Class A, ICES-001 Group 1 Class A, AS/NZS CISPR11 Group 1 Class A, KN61000-6-1, KN11 Group 1 Class A
Safety		IEC61010-1/EN61010-1, CAN/CSA-C22.2 No. 61010-1
Certifications		CE, cCSAus, RCM, ICES/NMB-001, KC
Warm-up		1 hour
Dimensions	Case	88 mm H x 213 mm W x 450 mm D
	Working	180 mm H x 260 mm W x 480 mm D (with handle and feet)
Weight	Net	6.0 kg (B2961B), 7.4 kg (B2962B)
	Shipping	9.5 kg (B2961B), 11.0 kg (B2962B)

Front panel operation	
Front panel interface	4.3" TFT color display (480x272, with LED backlight) with keypads and rotary knob
View mode	Single view, Dual view and Graph view
Hardkeys	Single Trigger and Auto Trigger control, 10-key, Rotary Knob and Cursors, Channel on/off, View, Cancel/Local
Softkeys	Function, System and Input Assist Keys
Indicators	Channel (measurement) status, System status

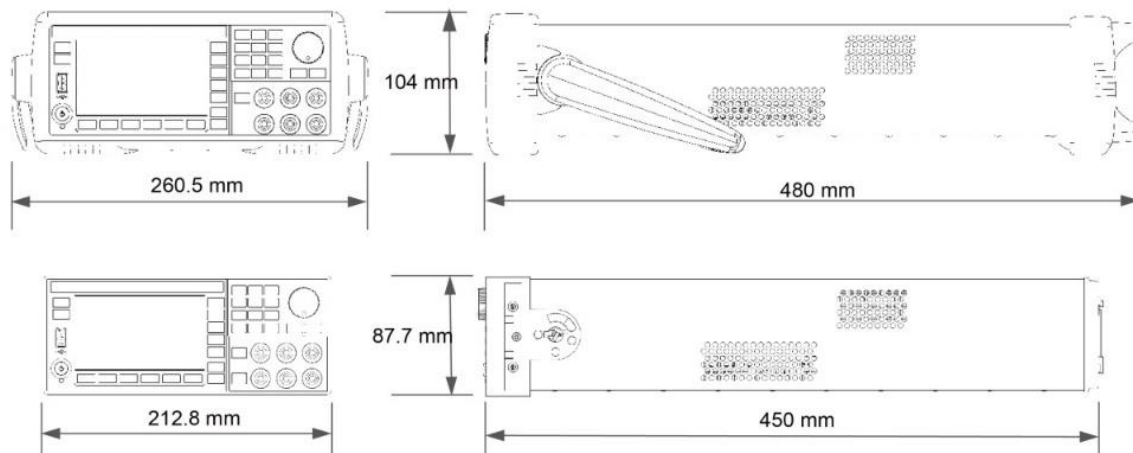

Input/output connectivity		
GPIB		IEEE-488.2
Ethernet		100BASE-T/10BASE-T
USB		USB 2.0 host controller(front), USB 2.0 device interface (rear)
Digital I/O	Connector type	25-pin female D
	Input/output pins	14 open drain I/O bits
	Absolute max input voltage	5.25 V
	Absolute min input voltage	-0.25 V
	Logic low max input voltage	0.8 V
	Logic high min input voltage	2.0 V
	Max source current	1 mA @ $V_{out} = 0$ V
	Max sink current	50 mA @ $V_{out} = 5$ V
	5 V power supply pin	Limited to 500 mA, solid state fuse protected
	Safety interlock pin	One active high pin and one active low pin. Activation of both pin enables output voltage > 42 V
Max number of simultaneously triggered units (using Digital I/O) <sup>1</sup>		8

1. Supplemental characteristics.

Program, software and drivers	
Programming	SCPI
Program memory	100 kB (2500 lines typical)
LXI compliance	LXI Core Conformance
Software available	PW9251A PathWave IV Curve Software, Graphical Web Interface, PathWave BenchVue
Drivers available	IVI-C, IVI-COM drivers, LabVIEW drivers

Software prerequisites		
PW9251A PathWave IV Curve Software	Operating system	Windows 10 (64 bit),
	Processor	Intel Core i5 (or equivalent)
	RAM	8 GB
	Storage Drive	900 MB free space for Windows
	Display resolution	1920 x 1080 minimum
	Interfaces	USB, GPIB, LAN
Pathwave BenchVue	Operating system	Windows 10 32-bit and 64-bit (Professional, Enterprise, Education, Home versions) Windows 8 32-bit and 64-bit (Professional, Enterprise, Core)
	CPU	1 GHz or faster (2 GHz or greater recommended)
	RAM	1 GB (32-bit) or 2 GB (64-bit) (3 GB or greater recommended)
	Display resolution	1024 x 768 minimum for single instrument view (higher resolutions are recommended for multiple instrument view)
	Interfaces	USB, GPIB, LAN, RS-232 <sup>1</sup>

1. RS-232 Interface is not available on B2900 family.

## Furnished Accessories

Power cable, USB cable, Quick Reference (English)

## Ordering Information

Model number	
B2961B	6.5 Digit Low Noise Power Source, 32 W, 210 V, 3 A, 1 ch
B2962B	6.5 Digit Low Noise Power Source, 32 W, 210 V, 3 A, 2 ch

Options	
1A7	Calibration + Uncertainties + Guardbanding (Not Accredited)
A6J	ANSI Z540-1-1994 Calibration
UK6	Commercial Calibration Certificate with Test Data

Accessories	
N1297A	Banana - Triax adapter for 2-wire (non Kelvin) connection
N1297B	Banana - Triax adapter for 4-wire (Kelvin) connection
N1298A	High current ultra low noise filter, 21 V/500 mA, 10 $\Omega$
N1298B	Ultra low noise filter, 42 V/105 mA, 50 $\Omega$
N1298C	Low noise filter, 210 V/3 A
N1294A-011	Interlock cable for 16442B (1.5 m)
N1294A-012	Interlock cable for 16442B (3.0 m)
N1294A-031	GPIO-BNC trigger adapter
16494A-001	Low leakage triax cable (1.5 m)
16494A-002	Low leakage triax cable (3.0 m)
16494A-003	Low leakage triax cable (80 cm)
16494A-004	Low leakage triax cable (40 cm)
16494A-005	Low leakage triax cable (4.0 m)
1CM124A	Rack mount flange kit

Learn more at: [www.keysight.com](http://www.keysight.com)

For more information on Keysight Technologies' products, applications, or services, please contact your local Keysight office. The complete list is available at: [www.keysight.com/find/contactus](http://www.keysight.com/find/contactus)



Mess- und Prüftechnik. Die Experten.

**Ihr Ansprechpartner /  
Your Partner:**

**dataTec AG**  
E-Mail: [info@datatec.eu](mailto:info@datatec.eu)  
>>> [www.datatec.eu](http://www.datatec.eu)

 **KEYSIGHT**  
Authorized Premium  
Distributor

Find us at [www.keysight.com](http://www.keysight.com)

This information is subject to change without notice. © Keysight Technologies, 2020 - 2023, Published in USA, May 2, 2023, 3120-1467.EN