

Operating Manual

Safety Tester Series S 1802M

Date: 16 Feb 2026



Mess- und Prüftechnik. Die Experten.

Ihr Ansprechpartner /
Your Partner:

dataTec AG

E-Mail: info@datatec.eu

datatec.eu

EXKLUSIVER
VERTRIEBSPARTNER
VON

SPSelectronic

SPS electronic GmbH
Eugen-Bolz-Straße 8, 74523 Schwäbisch Hall

Phone: +49 791 20 212 - 0
Fax: +49 791 20 212 - 999

e-mail: info@spselectronic.com
Internet: www.spselectronic.com

Table of Contents

1	General Information	5
1.1	Information on this operating manual	5
1.2	Requirements for the operation of this device	6
1.2.1	Regulations for application	6
1.2.2	Product liability	6
1.3	General safety regulations	7
1.3.1	Obligations of the operator	7
1.3.2	Operating instructions for personnel	7
1.3.3	Safety installations	8
1.3.4	Note on possible disorder of USB devices	8
1.3.5	Information on further publications	8
2	Description	9
2.1	Device functions	9
2.2	Technical Data	10
2.3	Set-up of device	12
2.3.1	Front side	12
2.3.2	Rear side	13
3	Putting into operation	14
3.1	Requirements	14
3.2	Connection of device	14
3.3	Switching the device on	14
3.4	Switching the device off	14
4	General Operation	15
4.1	Explanation of operating elements	15
4.2	Display	16
4.2.1	Start Screen	16
4.2.2	Start Screen: Quick overview	17
4.3	Operation of screen menus	18
4.3.1	Entry of letters and numbers	18
4.4	Changing the Test Program	19
4.4.1	Search in the program list	20
5	Testing Operation	21
5.1	Outline	21
5.2	Screen display during a test step	22
5.3	Reviewing Test results	23

6	Creation of test programmes	24
6.1	General information	24
6.1.1	Integrated Dummy Test Program	24
6.2	Managing of test programs	24
6.2.1	Import and Export of Test Programs	25
6.3	Editing of a test program	26
6.3.1	Common parameters and programme settings	27
6.3.2	PE: Protective Earth Test	28
6.3.3	IS: Insulation Resistance Test	29
6.3.4	HV: High Voltage Test	30
6.3.5	VT: Visual Test	31
6.3.6	I/O-test	32
7	Additional Functions and Settings	33
7.1	Single Test	33
7.2	Setting of password	33
7.3	Operation Mode	34
7.3.1	Automatic	34
7.3.2	IO signals	34
7.3.3	Exclusive start	34
7.3.4	Results	35
7.3.5	Security	36
7.4	Menu / "Setting"	37
7.4.1	Interface: Ethernet	37
7.4.2	Buzzer	37
7.4.3	Language	37
7.4.4	Setting of date and time	38
7.4.5	Factory reset	38
7.5	Info	38
Annex		39
A	Interface Configuration	39
A-1	External I/O Interface X6	39
A-2	Rear connectors for test voltages	40
B	USB devices, and "Testing with High Voltage"	41
C	Troubleshooting	41

1 General Information

1.1 Information on this operating manual

This operating manual is part of the technical documentation for the safety tester S1802M of SPS electronic GmbH.

This operating manual contains all the information on how to operate this device properly, safely and economically, how to prevent dangerous situations, how to reduce repair costs and downtimes and how to prolong the service life of these devices.

Should you, while perusing this operating manual, find any misprints, any information you do not understand or which are incorrect please do not hesitate to inform SPS electronic GmbH about same.

Pictographs and Symbols

- **Warnings** are characterized by warning triangles with danger symbol and warn of dangers which can lead to personal injury and/or material damage:



General Warning



Danger caused by electric current or voltage

- **Information** on same are characterized by the Information Pictograph and give advice or additional information:



You can order accessories directly from *SPS electronic GmbH*.

- **Continuations** of contextual paragraphs on the next page are characterized by the symbol  on the right-hand margin.

1.2 Requirements for the operation of this device

1.2.1 Regulations for application

The tester must be in an operational and reliable condition.

Only personnel having completely read and understood this operating manual and who are authorized skilled electricians or who have been instructed in electrical engineering are allowed to perform any operations with and at the testers.

The tester is not to be operated if or for:

- operations are performed which are not specified in this operating manual or which have not been recommended by SPS electronic GmbH concerning installation, operation, maintenance and service.
- unauthorized alterations and/or repairs
- dismantling and/or avoiding of safety devices
- use of components, tools, additional installations, supplements and working material which have not been approved or recommended by SPS electronic GmbH
- building in of spare parts which are not original SPS electronic GmbH spare parts or of spare parts from suppliers not recommended by SPS electronic GmbH

1.2.2 Product liability

The testers have been produced, adjusted and tested according to the state of the art and the approved safety requirements.

The devices comply with the conditions agreed upon by contract of the confirmation of order concerning execution, single parts and accessories selection.

SPS electronic GmbH will be liable for errors or omissions to the extent of the guarantee liabilities of the confirmation of order.

Applicable are the general conditions of delivery of the Central Association of Electrical Engineering and the Electronics Industry, registered association (ZVEI).

The contents of this operating manual is in compliance with the condition of the tester on the date when same was drawn up.

Subject to change are technical alterations because of further developments and improvements of these products by SPS electronic GmbH.

Liability claims can therefore not be derived from the contents of this operating manual (data, descriptions, graphs, misprints, etc.).

Errors and omissions excepted!



**SPS electronic GmbH will only be liable in case of application of the testers according to regulations (pl. see 1.2.1).
If those regulations have not been applied the operator is solely responsible for risks of hazard to body and life of the user or a third party and impairments of the tester and other material assets!**

1.3 General safety regulations

This safety tester S1802M has been manufactured according to the state of the art at the time of its delivery.

Nevertheless the tester is not without hazards if it is applied by untrained personnel, applied improperly or not applied according to regulations.

In addition to this operating manual the generally applicable legal regulations and other binding instructions concerning safety regulations, regulations for preventing accidents and regulations for the protection of the environment must be adhered to.



Beware of high electronic voltage and electromagnetic fields

In case of defective test objects, like e.g. arc-overs, there can occur electromagnetic fields. This is of particular concern to persons with active or passive medical devices, like e.g. cardiac pacemaker.



1.3.1 Obligations of the operator

- The tester is only to be operated according to regulations and in operational condition (see chap. 1.2.1)
- Protective and safety devices, locking devices and couplings, etc. have to be inspected by an expert at least once a year.
- A protocol on the test results has to be drawn up in form of a **test report** same has to be retained.
- Instructions on operations with or at a machine or installation as to hazards to health and/or life of persons are obligatory.
- Persons who operate with or at an S1802M have to confirm by their signature to have read and comprehended this operating manual especially in regard to the operating instructions.
- Dangerous zones resulting from the integration of the tester into a system or a device have to be located by the operator and safeguarded against.

When assembling or installing devices, systems or items of equipment of different manufacturers or suppliers and after modifications by company or service personnel where changes within the electric equipment were made the operator has, before putting into operation, to perform a precise inspection according to the accident prevention regulations VBG 4 in compliance with the individually applicable rules of electrical engineering.

1.3.2 Operating instructions for personnel

- Operating instructions, general instructions and regulations are part of the tester and have to be accessible, readable and complete for all those who operate with or at the S1802M.
- Before operating with or at the S1802M questions have to be answered or uncertainties have to be explained by the personnel in charge.
- Any operations with or at the S1802M may only be performed by workers skilled in electrical engineering or trained in electronic engineering and who have been given instructions for such operations and thus been authorized by the operator.
- Testing personnel may only operate the S1802M when a skilled electrician is in charge.
- Adjustments, service and inspections have to be performed according to the instructions specified and according to schedule.

1.3.3 Safety installations

The S1802M testers are, for the safety of the operating personnel, equipped with below safety equipment:

- safety current limiting for insulation test and high voltage test
- protective low voltage for protective wire test

Capacitive DUTs and DC high voltage



When testing with DC high voltage, capacitive DUTs are getting charged. At the end of an insulation test or HV-DC test, the test object is discharged, the PASS / FAIL signal is output only after the end of the discharge. That's why tests with DC high voltage always have to go through to the end in a controlled manner. If the contact is prematurely disconnected (or if the tester is switched off, mains voltage failure, etc.), the test object is not discharged and may still be charged with dangerously high energy!

This also applies to safety current-limited testers (<10 mA DC)! Although the test voltage / current of these devices is not dangerous as such in direct contact, capacitive DUTs can still be charged with dangerously high energy!

If such conditions are met by appropriate DUT types, the personal safety measures according to EN 50191 must be observed, even with safety-limited test equipment.

1.3.4 Note on possible disorder of USB devices

When testing with high-voltage, it is possible that failing testpieces may cause disorder of USB devices in close surrounding of the test field.

Please see Annex A-2 for a problem description, and measures to avoid.

1.3.5 Information on further publications

For the protection of persons the trade associations and unions have published below literature:

- DIN EN 50191 Installation and Operation of Electrical Installations
- DIN EN 50274 Protection against Electric Shock –
Protection against unintended direct contact of dangerous active parts
- DIN 40 008 part 3 Safety Signs for Electrical Engineering;
Warning Signs and Additional Signs
- DIN 40 050 IP-Protective System, Protection against Contact, Foreign Matter and Water
for Production Equipment
- DIN 57100 Specifications for the Installation of Power Plants with Nominal Voltages of
up to 1000 V
- BGI 891 Establishing and operation of electrical test plants

2 Description

The devices S1802M are safety current limited acc. to EN 50 191, and are not equipped with a hardware safety circuit.

2.1 Device functions

You can perform safety tests at electric devices according to standard test regulations (EN, IEC, VDE etc.) with the safety tester S1802M.

Below tests can be performed:

	S1802M
PE: Protective earthing test	10 – 30 A AC
IS: Insulation test	100–6000 V DC / 10 mA
HV: High voltage test	100–6000 V DC / 10 mA 100–5500 V AC / 3 mA

The test device works with a fully electronic high-voltage generator. The high voltage is readjusted fully automatically during the test operation, depending on the load, once the test voltage has been correctly adjusted.

If the voltage change is too fast (> 2% per full wave), the voltage drop will be recognized as an error.



2.2 Technical Data

Measurements and weights	
Width / depth / height	ca. 360 / 330 / 160 mm (14" / 3HU)
weight	ca. 10.0 kg

Ambient	
temperature	operation: 15 °C – 40 °C storage: 5 °C – 60 °C
Air humidity	max. 70 % (non-condensing)

Connection data	
Power supply	wide range 90-253 V / 50-60 Hz
Power input	max. 500 VA

PE Test (Protective Conductor Test)			
Test current	programmable from 10 to 30 A AC		
Thresholds	free programmable up to 400 mΩ		
Measuring range	range 0 up to 400 mΩ	resolution 1 mΩ	accuracy display 1.5% of meas.range
Typically achieved max. measurements	Test with 6 V: 10 A : 400 mΩ 30 A : 200 mΩ Test with 12 V: 10 A : 400 mΩ 30 A : 350 mΩ		

IS Test (Insulation Test)			
Test voltage	free programmable from 100* up to 6000 V DC * up to 199 V not specified residual ripple DC: < 3% acc. VDE 0432 / EN 61180		
Short circuit current	< 12 mA DC, safety current limited acc. to EN 50191		
Measuring range R	0.25 MΩ – 1000 MΩ overall. Tolerances: 200 – 1500V: 0.25 MΩ – 9.99 MΩ: 20% of meas.value ± 0.1 MΩ 10.0 MΩ – 49.9 MΩ: 20% of meas.value ± 0.1 MΩ 50.0 MΩ – 99.9 MΩ: 30% of meas.value ± 1 MΩ 100 MΩ – 500 MΩ: 30% of meas.value ± 1 MΩ 1501 – 6000V: 0.25 MΩ – 9.99 MΩ: 15% of meas.value ± 0.1 MΩ 10.0 MΩ – 49.9 MΩ: 15% of meas.value ± 0.1 MΩ 50.0 MΩ – 99.9 MΩ: 30% of meas.value ± 1 MΩ 100 MΩ – 1.00 GΩ: 30% of meas.value ± 1 MΩ		
Voltage display	range 6000 V	resolution display 1 V	accuracy 1.5% of nominal value ± 10 V

* Maximum capacitive load should not exceed 1μF per second of ramp time. Otherwise there is chance for ringing (over-voltage).

The total capacitive load must not exceed 10μF, otherwise correct discharge can not be guaranteed.

HV Test (High Voltage Test)			
Test voltage	free programmable from 100* up to 6000 V DC * up to 199 V not specified free programmable from 100* up to 5500 V AC residual ripple DC: < 3% acc. VDE 0432 / EN 61180		
Short circuit current	≤ 3 mA AC / < 12 mA DC		
Measuring range current	range 40µA DC 200µA DC 1mA DC 10mA DC 200µA AC 1mA AC 3mA AC	resolution display 0.001 mA 0.001 mA 0.001 mA 0.001 mA 0.001 mA 0.001 mA 0.001 mA	accuracy 5% of meas.range 2% of meas.range 1.5% of meas.range 1.5% of meas.range 2.5% of meas.range 2.5% of meas.range 5% of meas.range
Measuring range voltage	range 5.5 kVAC / 6.0 kVDC	resolution display 0.001 kV	accuracy 1.5% of nominal value ± 0.01 kV

* Maximum capacitive load should not exceed 1µF per second of ramp time. Otherwise there is chance for ringing (over-voltage).

The total capacitive load must not exceed 10µF, otherwise correct discharge can not be guaranteed.

I/O Test	
Inputs 1 – 8	input voltage: 20 V DC – 28 V DC input resistance: 4.7 kΩ
Outputs 1 - 8	output voltage: 24VDC output current: max. 250 mA per output / max. 1000 mA total potential free to test voltage and internal supply, short-circuit proof

Features
<ul style="list-style-type: none"> • Table housing, with integrated LC display • USB interface for connection of PC keyboard, or for firmware updates • Ethernet interface for firmware updates, or for remote operation.

* Tentative specifications. Subject to change.

2.3 Set-up of device

2.3.1 Front side

S1802M:

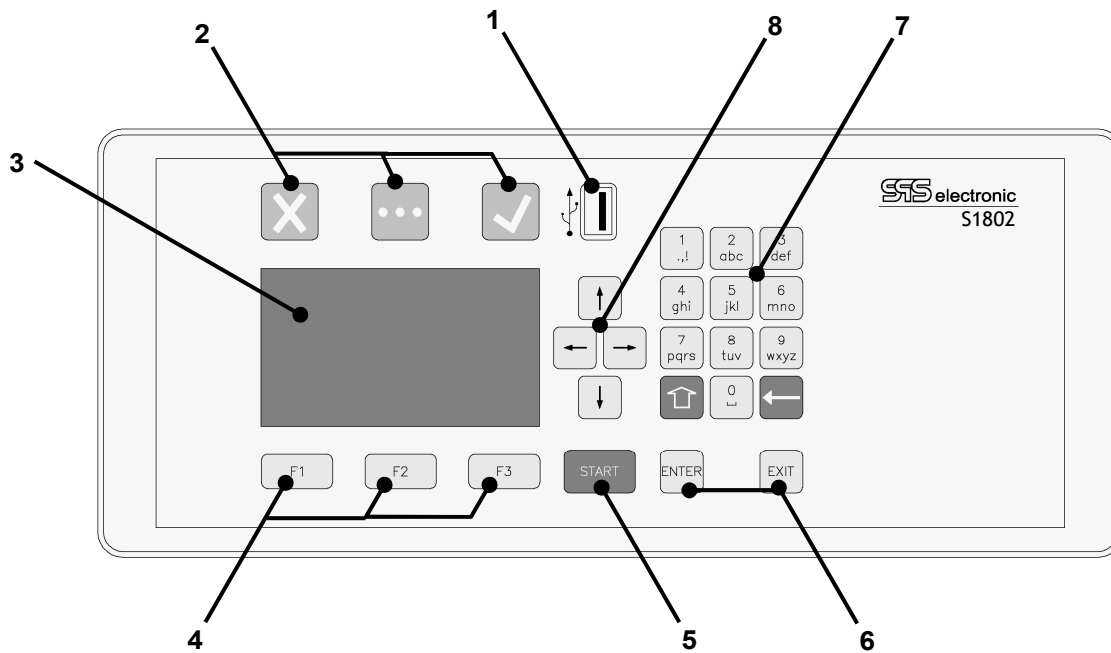

- | | | |
|---|----------------------|---|
| 1 | USB Port | – to connect an USB-stick (data exchange, firmware update, etc.) |
| 2 | Telltale lights | – indicating test results or running test |
| 3 | LC – Display | – well, it's the display. |
| 4 | Function Keys | – quick handling of on-screen messages |
| 5 | START Key | – starts the next test run |
| 6 | ENTER/EXIT keys | – acknowledge or abort actions |
| 7 | Alpha-numeric keypad | – for entry of numbers and letters (editing of test programs, etc.) |
| 8 | Navigation keys | – to move between different on-screen elements |

2.3.2 Rear side

S1802M:

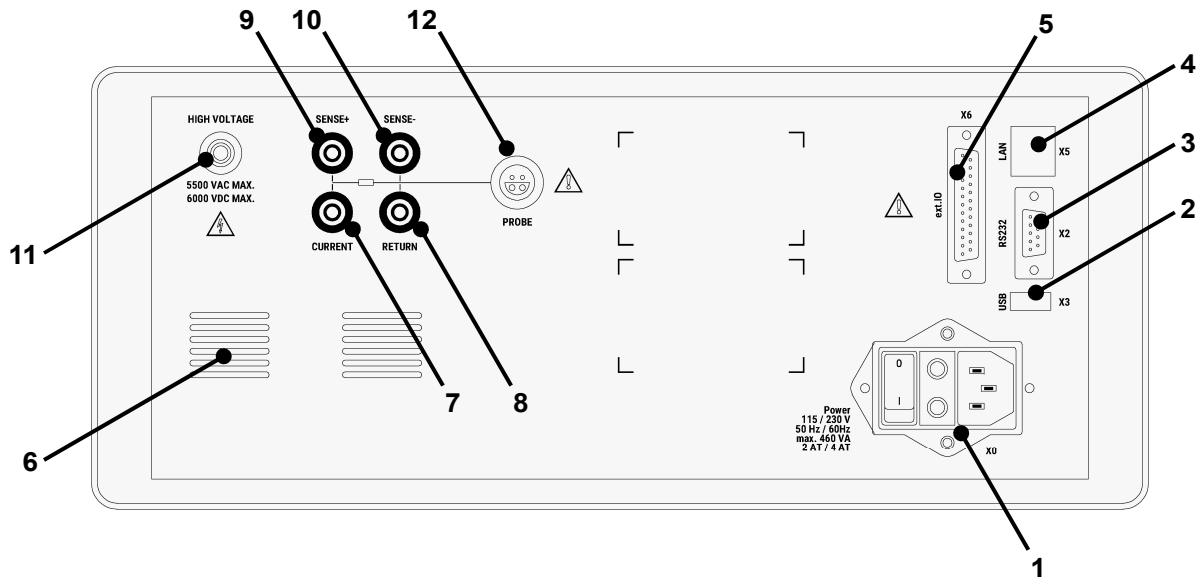

- 1 IEC power inlet for mains cable (X0),
power switch for switching device on and off,
2 fuses (115V: 4A / 230V: 2A, slow-blow), for protecting the mains input X0
- 2 USB connector (X3)
- 3 RS232 interface: serial interface for connection of a PC (X2)
- 4 LAN interface: Ethernet connection (X5)
- 5 I/O interface (X6)
- 6 ventilation grid – keep absolutely free of obstruction!
- 7 connector "current" (pe a) (HV–)
- 8 connector "return" (pe b)
- 9 connector "sense+" (pe b')
- 10 connector "sense–" (pe a')
- 11 connector "High Voltage" (HV+)
- 12 connector for PE probe

3 Putting into operation

3.1 Requirements



Tester *S1802M* as well as all of the electric connections and lines must be in operational and reliable condition.

The General Safety Regulations (pl. see chapter 1.3) and the generally applicable legal rules as well as other binding directives for industrial safety, for accident prevention and for the protection of the environment have to be adhered to and persons staying in the area of operation must be informed respectively.



There is danger to life caused by electric current or voltage in case of handling electric installations inappropriately!

3.2 Connection of device

1. switch off, if necessary, power switch at tester
2. plug power cable of tester into cold equipment socket (X0) at back of device
3. connect power cable to power supply
4. If provided for connect external devices to interfaces

3.3 Switching the device on

The S1802M is switched on with the power switch at the back of the device.

The test device then is starting its internal Operating System. This takes approx. 20 seconds. When finished, the device is showing the start screen (see p. 16), and is ready to perform tests.

3.4 Switching the device off

The safety tester S1802M is switched off with the power switch at the back of the device.



In case of tests with high voltage (IS- and HV-test) the DUT has to remain connected until a test result is displayed. At the end of the test time the DUT is discharged.
If the S1802M is switched off prematurely, the DUT cannot be discharged!

4 General Operation

4.1 Explanation of operating elements

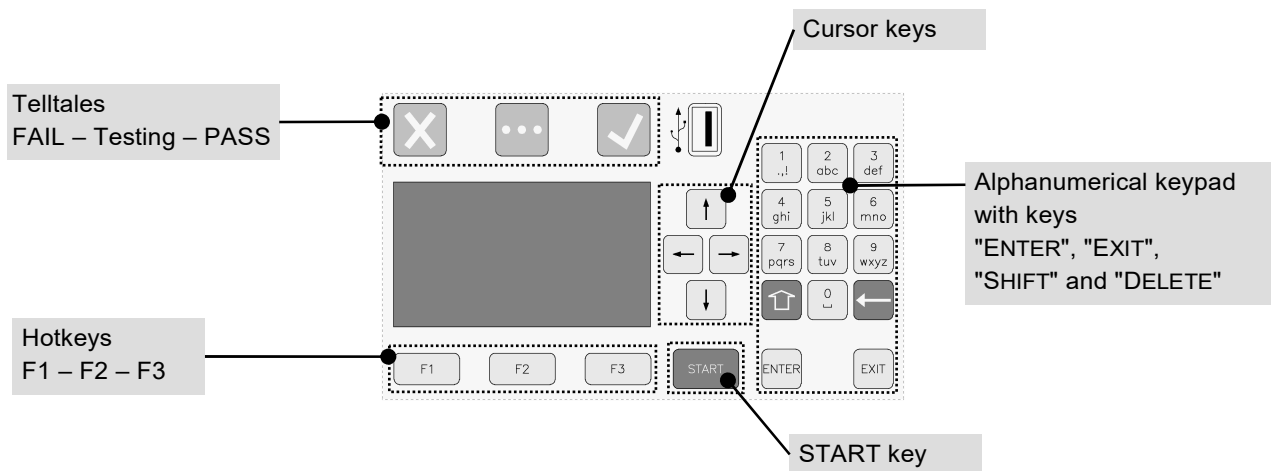

Operating element	Function
Telltale lights	Signals the latest test result: <input checked="" type="checkbox"/> = PASS , <input type="checkbox"/> = FAIL <input type="checkbox"/> = Indicates that a test is actually running
Hotkeys	Shortcut keys to interact with messages shown on the display
Keypad	To enter numbers for test parameters, letters or special characters for program names or text messages, etc. With "Shift" key <input type="checkbox"/> (to switch between small-letters and capital-letters), and "Backspace" key <input type="checkbox"/> (to delete the character(s) left of the entry mark)
Cursor keys	For navigation in screen menus, and adjustment of test parameters
START key	Starts the next test run

4.2 Display

4.2.1 Start Screen

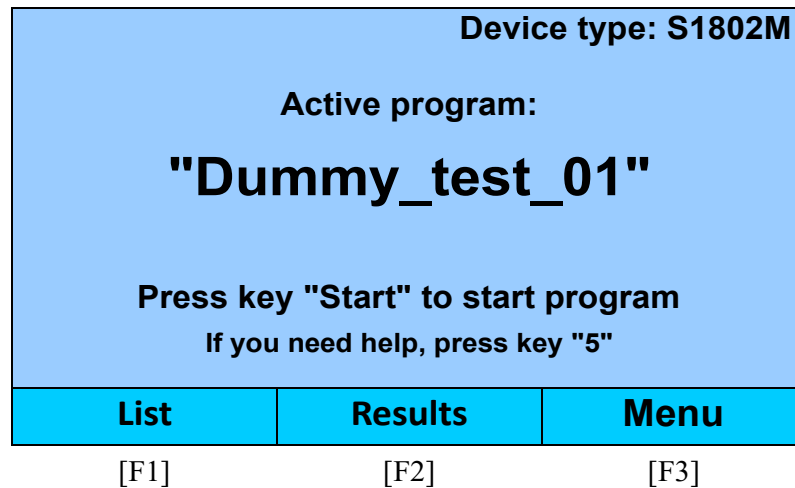

This is the start screen of device S1802M. From here, all device functions can be accessed quickly.

The start screen is shown –

- after switch-on of the device
- after the previous test run has finished

Shown is the currently active test program. It can be started immediately with the key "START".

- Changing the test program:
Press [F1] "List". This brings up the program list, from which the desired program can be selected.
- View results of last test run:
Press [F2] "Results". This brings up the results dialog.
- The key [F3] "Menu" opens the system menu. Here you can create or change test programs (with "Editor"), call the single-test mode, or change the system settings to your requirements.

The device's system area can be password-protected on several levels. A user can only access areas for which he has the required password.

4.2.2 Start Screen: Quick overview

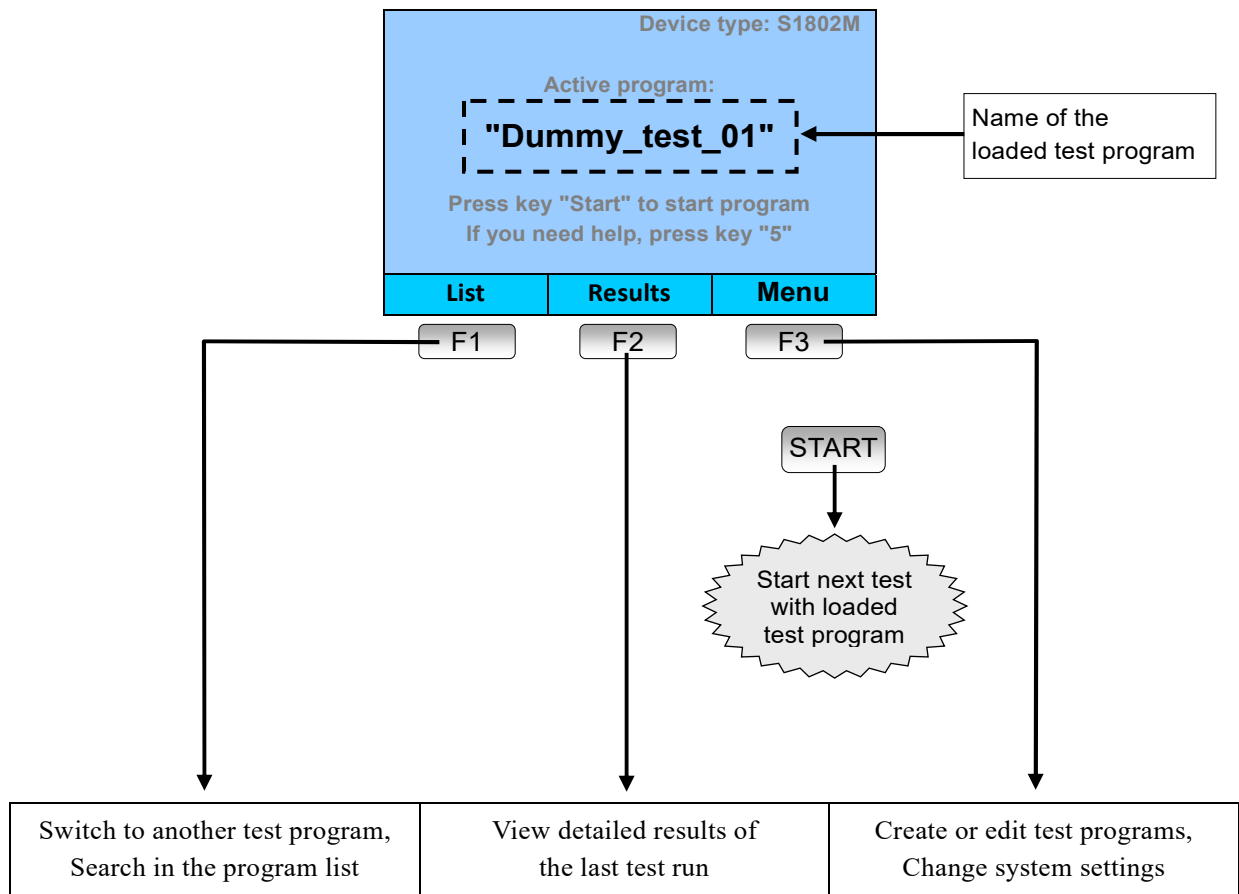

4.3 Operation of screen menus

Operation of screen menus is taken out by means of the function keys F1, F2 F3, and the arrow keys.

The function keys have a context-adaptive description at the bottom of the screen, showing which actions currently can be done.

With the UP/DOWN arrow keys you switch between the different elements on the screen.

With the LEFT/RIGHT arrow keys the currently active element, highlighted in yellow, can be changed in its value (e.g. test parameters).

4.3.1 Entry of letters and numbers

For several actions the user has to enter numbers and/or letters, e.g. when assigning a name for a test programme or when entering a password.

Entering of letters and numbers is carried out by the alphanumeric keypad. Operation has been made highly similar to that of most cellphone keypads: the keys have multiple assignments, the wished symbol is chosen by pushing a key repeatedly. When the key is not pushed anymore, the currently chosen symbol gets "fixed", and the entry mark jumps to the next position. (The delay time for snap-in is approx. 0.5 seconds.)

Key assignment

1	→	.	,	!	1	@	'	_	()	;	§	&	#
2	→	a	b	c	2	ä	à	á	â	ã	å	æ	ç	
3	→	d	e	f	3	ë	è	é	ê	ë				
4	→	g	h	i	4	ï	ì	í	î					
5	→	j	k	l	5	£								
6	→	m	n	o	6	ö	ò	ó	ô	õ	ø	ñ		
7	→	p	q	r	s	7	ß	\$						
8	→	t	u	v	8	ü	ù	ú	û					
9	→	w	x	y	z	9	ÿ	ý	þ					
0	→		0	↵	-	+	=	%						

Note: this full assignment with all letters and special characters is only active when text is entered in a general text field (like e.g. program names, or text message in TV step).

When a field is edited that can only take numbers (e.g. parameters in test steps), then the keypad automatically is set to numeric mode, i.e. each key produces only its number.

Details on key '0' special characters

The first item ' ' is the "space" or "blank" character.

The item '↵' is "carriage return", i.e. a line break, to switch from the current line to a new one.

4.4 Changing the Test Program

To switch to another test program, press the key F1 "List" at the main screen:

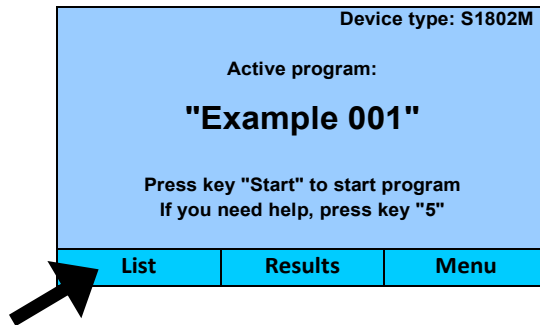

This will bring up the test program list:

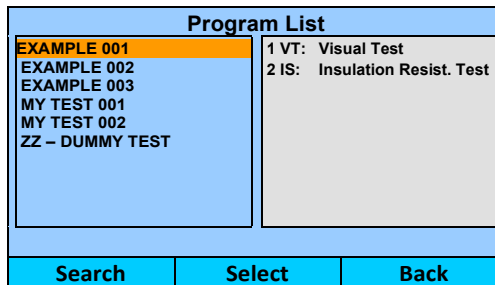

Use the UP/DOWN arrow keys to move the yellow mark to the desired program:

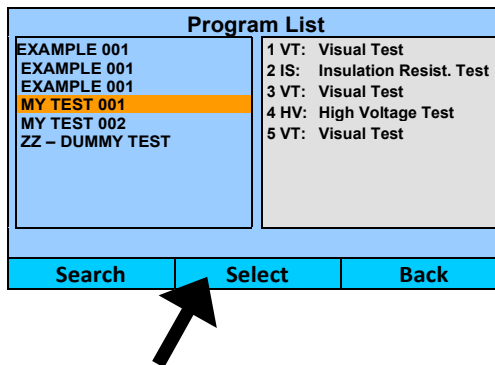

When pressing F2 "Select", the highlighted program is loaded, and ready to be used for testing.

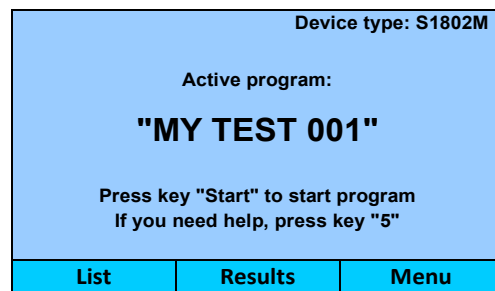

4.4.1 Search in the program list

If the program list contains a lot of test programs, one can use the "Search" feature to filter the list.

Pressing F1 "Search" will bring up a textbox to enter a term to search for:

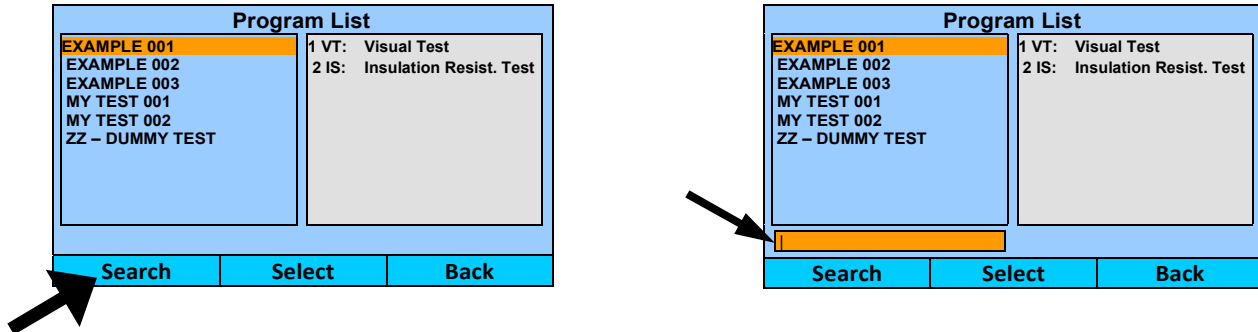

Now a search term can be entered with the keypad. The program list will be filtered, so that only those programs are shown that contain the exact search term in their name.

In the given example, if e.g. "02" is entered in the search box, the list will only show the programs "IEC 60204" and "MY TEST 002". All other programs do not have "02" in their name, and therefore will not be shown.

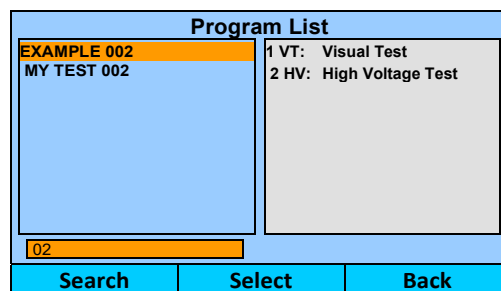

Program list, filtered by a search term

5 Testing Operation

5.1 Outline

- **Connecting the DUT**

When using a connection panel (A7 / A8), the plug of the DUT is plugged into the socket on the connection panel. The PE test is carried out with the test probe connected to the console.
For "manual" contacting, use the connection diagram described in the annex.

- **Loading of test programme**

After loading a test program (see previous two pages), the program is shown in the start screen:

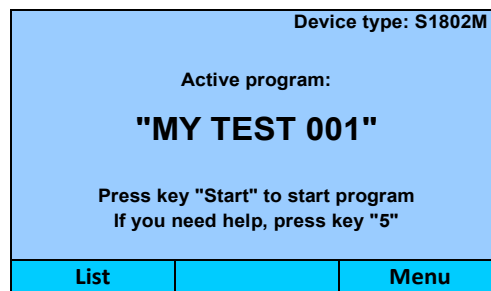

- **Start of test**

To run the test program, press the blue key START.

- **Test step process**

The test steps are consecutively carried out with their programmed parameters.

Depending on test step and set start control the single steps will start automatically or when contacting DUT or after activating start control.

While one test step is in process the current measuring values are displayed. (See figures on next page.)

- **Test step result**

If a test step ends with PASS, the next step will start immediately.

If a test step ends with FAIL, then:

- the test process is stopped.
 - the red telltale is glowing
 - the screen background is colored red.
 - the cause of the error is shown in the status line of the test step.
- The error must be acknowledged by pressing F2 "Exit".

- **Test result**

If all test steps resulted in PASS, the complete test result is PASS.

The device will show the start screen again, colored in green, to indicate that the last test run was good.

If the result of any one test step was FAIL, the complete test result is FAIL.

After error acknowledgement, the device will show the start screen again, in standard coloring.

In the manual test mode you can now either

- immediately start the next test with START key, or
- examine the measuring values of the test process (pl. see chpt.5.3, p.23)

5.2 Screen display during a test step

When a test step is running, all important data is shown on the screen:

- remaining time until end of step
- the threshold values that must be met
- the realtime readout of actually measured values

Detailed examples of information displayed by all test steps:

PE: Protective Earth Test		
<input checked="" type="checkbox"/> 2: Continuity Test	<div style="width: 82%;"><div style="background-color: blue; height: 10px;"></div></div> 82%	
<input type="checkbox"/> 3: Protective Earth Test		
<input type="checkbox"/> 4: Insulation Resistance Test		
R =	384 mΩ	R max = 400 mΩ I min = 10 A
I =	15.6 A	t = 2.3s
{ Status Message }		
Exit		

HV: High Voltage Test		
<input checked="" type="checkbox"/> 4: Insulation Resistance Test	<div style="width: 64%;"><div style="background-color: blue; height: 10px;"></div></div> 64%	
<input type="checkbox"/> 5: High Voltage Test		
<input type="checkbox"/> 6: Visual Test		
U_~ =	1.002 kV	I max = 1.00 mA U nom = 1.000 kV
I =	0.045 mA	t = 2.3s I min = 0 mA
{ Status Message }		
Exit		

IS: Insulation Resistance Test		
<input checked="" type="checkbox"/> 3: Visual Test	<div style="width: 73%;"><div style="background-color: blue; height: 10px;"></div></div> 73%	
<input type="checkbox"/> 4: Insulation Resistance Test		
<input type="checkbox"/> 5: High Voltage Test		
R =	1.84 GΩ	R min = 5.00 MΩ U nom = 1000 V
U =	1013 V	t = 2.3s
{ Status Message }		
Exit		

VT: Visual Test		
<input checked="" type="checkbox"/> 5: High Voltage Test		
<input type="checkbox"/> 6: Visual Test		
<input type="checkbox"/>		
IS THE GREEN LAMP OF THE DUT GLOWING?		
{ Status Message }		
YES	Exit	NO

5.3 Reviewing Test results

When a test run has finished and the device is showing the start screen again, the key F2 "Results" can be used to review the results of the latest test run:

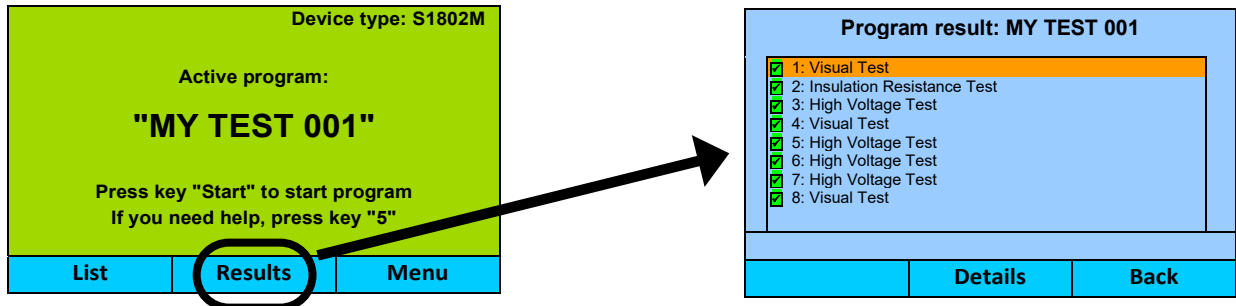

In the result list, all test steps of the program are shown. The results GOOD or FAIL are indicated by a symbol in front of each test step.

To see the detailed results of a test step, move the yellow line to any test step, and press F2 "Details":

Test result: PE: Protective Earth Test

	reference		actual	
R (mΩ)	min: 0	max: 400	384	✓
I (A)	min: 10.00	max: 16.00	15.1	✓

Test OK ✓

Back

Test result: HV: High Voltage Test

	reference		actual	
U (kV)	min: 0.900	max: 1.100	1.001	✓
I (mA)	min: 0.000	max: 1.000	0.046	✓

Test OK ✓

Back

Test result: IS: Insulation Resistance Test

	reference		actual	
R (GΩ)	min: 5.00	max: 10000.00	1517.91	✓
U (V)	min: 900	max: 1100	1017	✓

Test OK ✓

Back

6 Creation of test programmes

6.1 General information

Due to the functionality of the test programmes of the S1802M complex test processes can be realized comfortably. Administration and organisation of various programmes for different DUT types can be carried out without problems.

The created test programmes are filed internally in a non-volatile memory and remain filed even if the device is completely cut off from power supply.

To operate with test programmes you select the entry "editor" in the main menu.

6.1.1 Integrated Dummy Test Program

The safety tester S1802M comes shipping with a premade "Dummy" test program.

The "Dummy" test program is tailored so that you can use a test dummy of SPS electronic to ensure the correct function of the tester. The dummy program guides through the testing procedure, using text steps to give instructions what has to be switched at the dummy, what has to be connected at next, etc. If the tester recognizes all "fail"-simulations as "error", and all "pass"-simulations as pass, then the correct function of the tester is assured.

6.2 Managing of test programs

To create a new test program or to edit existing test programs, the editor module is used:

Start Screen → F3 "Menu" → "Editor"

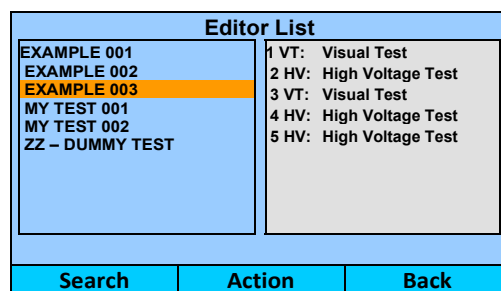

On the left side of the window you will see a list with the names of all test programmes stored.

On the right side the test steps of the programme which are marked in the list are displayed. Within a programme all test steps are numbered consecutively.

The available options are called by F2 "Action", which brings up the context menu:

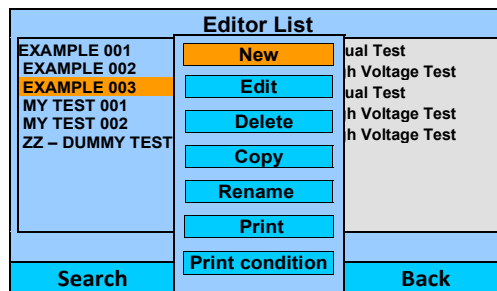

New – This option will create a new test program. First a dialogue is displayed into which a name for the new test program must be entered. After input and acknowledgement of name, test steps can be added to the program.

Note: The position of programs in the list can not be chosen. All programs are listed in alphabetical order. If you want to achieve a certain order of test programs, this can be achieved e.g. by using numbers at the start of the program names.

Edit – If you select the action "Edit" then the selected test program will be opened for operation. You can then insert or delete test steps, or alter test parameters of existing test steps.

Delete – This will delete the selected program from the list.

Copy – With this option, a new program is created by duplicating the selected program. After choosing "Copy", you are prompted to enter a new name for the duplicated program.

Rename – With this option, you can change the name of the selected program.

Print – With this option, the selected program is printed on a connected printer.

Print condition – This option controls when to print a test protocol with test results:

- **Never** – printing of test results is disabled.
- **Always** – test results are printed after a test run
- **If good** – test results are printed only if the test result is "PASS"
- **If fail** – test results are printed only if the test result is "FAIL"

6.2.1 Import and Export of Test Programs

Test programs can be exported to a USB data carrier, or imported from there into the S1802M.

Export: Menu → Editor → F2 → "Copy" → "Export"

Import: Menu → Editor → F2 → "New" → "Import"

On the USB device, the programs are stored in the path X:\data\programs\.

When exporting, this structure is created (if it does not already exist). During import, this folder structure must be present in order for the programs to be found.

When copying the programs, existing files (with the same name) at the destination will be overwritten. There is no safety inquiry.

6.3 Editing of a test program

When a new program has been created, or an existing program was chosen with "Edit", the program is shown in detail view for further editing:

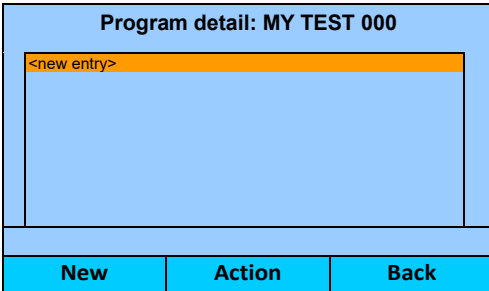

After creating a new program

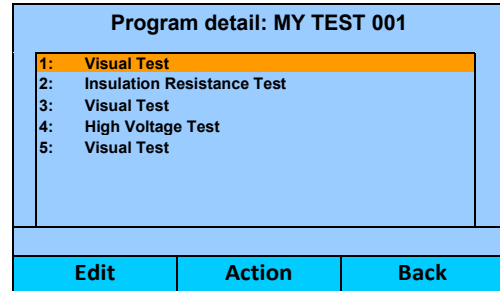

After opening a program for editing

The available options are called by F2 "Action", which brings up the context menu:

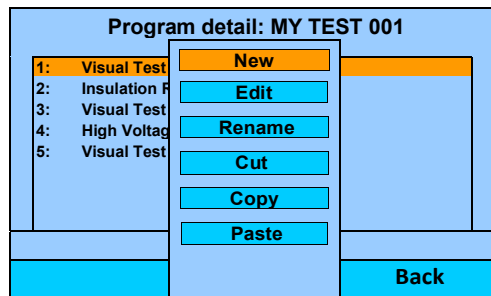

Action menu during program editing

- New** – This option will insert a new test step into the program. When "New" is actuated, a list with all available test steps will be shown. The desired test step is selected with Up/Down arrow keys, then by key F2 it is inserted into the test program. The new test step will be inserted after the test step that is currently selected/highlighted in the program.

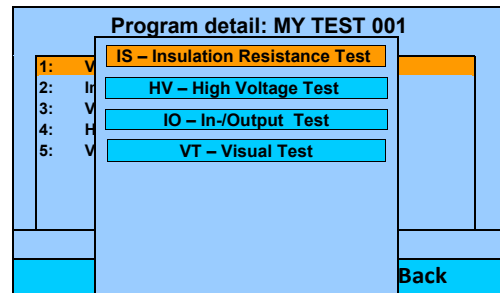

Selection when inserting a new test step

- Edit** – If you select the action "Edit" then the selected test step will be opened for operation.
- Rename** – With this option, you can change the name of the selected test step.
- Cut** – The selected test step is deleted out of the program. At the same time it is copied to an internal buffer, so that the step can be "pasted" into the program again.
- Copy** – The selected test step is copied to an internal buffer.
- Paste** – The test step from the internal buffer is inserted into the program.

Hint: by combining Cut+Paste, a test step can be moved from one location to another.

6.3.1 Common parameters and programme settings

Common to all test steps are the fields " Passed" and "Failed" on the right side of the test parameter menu:

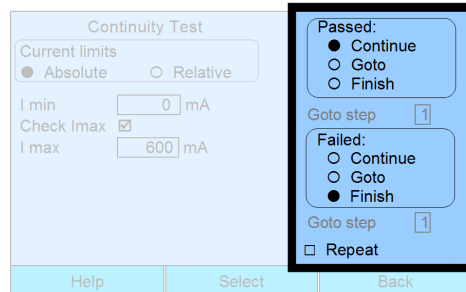

Via these two lines you can establish how to continue the test process, if the respective test steps end either with the result "Pass" or "Error":

- **Continue** Test process is continued with next test step of programme.
- **Go to step ##** You go to test step no. "##" and continue the test process from there.
- **End** Test process is ended, no further test steps are carried out.
- **Repeat** If the test step ends with "Error", a dialogue is displayed requesting if this test step is to be repeated.
If on repeating an error-free result is achieved the test step will be rated as "PASS".

6.3.2 PE: Protective Earth Test

The protective conductor test measures the resistance between PE (earthing) and housing of DUT. The resistance should be as low as possible.

If resistance values between R_{min} and R_{max} are measured, DUT has passed the test.

If resistance values lower than R_{min} or higher than R_{max} are measured, the test result will be "FAILED".

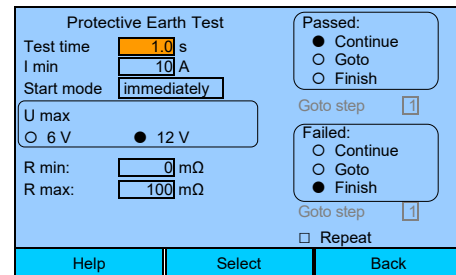

Explanation of test parameters for PE protective earth test:

• Test time	Preset value for complete duration of test	(0.1-99.9 s)
• I min	Minimum of test current required	(10-30 A)
• Start mode	(immediately/automatic/start button)	
○ immediately	Test is started immediately when calling up test step	
○ Automatic	Starts test automatically when contacting DUT	
○ Start button	Manual start of test via start key	
• U max	Selection of test voltage	(6 V / 12 V)
• Rmin	Minimum resistance required	(0 - 400 mΩ)
• Rmax	Maximum tolerable resistance	(0 - 400 mΩ)

Voltage application for PE-test:

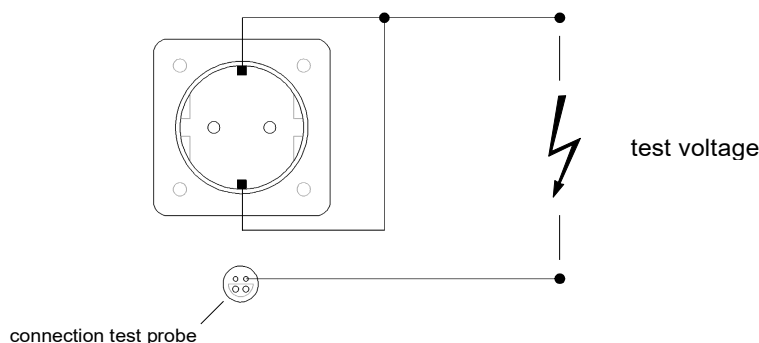

Standard method: DUT has to be connected to the power socket at the connection box. Testing is performed with PE probe connected at the connection box.

If it is not possible to connect the DUT to the socket, or if operation is done with "manual" contacting without connection box, the connection is made via the rear laboratory sockets. See also annex A-2.

6.3.3 IS: Insulation Resistance Test

With the insulation test, the insulation resistance between the contacted potentials is evaluated.

In case of insufficient or damaged electric strength of the DUT, an arc-over will occur.

Explanation of test parameters for IS insulation test:

• Test time	Preset value for duration of test (without ramp time)	(0.1 – 999.9 s)
• U nom	Preset value for test voltage	(100 – 6000 ¹⁾ V)
• Ramp up time	Preset value for voltage ramping at the start of the test	(0.0 – 999.9 s)
• I ramp	Activates custom current thresholds during voltage ramping	(<input type="checkbox"/> / <input checked="" type="checkbox"/>)
• R min	Required minimum resistance for PASS-result	(0.25 – 1000.00 MOhm)
• IR min / max	Minimum/maximum allowed current during voltage ramp	(0.00 – 10.00 mA)
• Connection	<i>Unused parameter</i>	<i>(Pistol)</i>
• Safety Ctrl	Selection how start signal / ext. protective circuit is to be queried <i>(See 7.3.5 / "Safety control", page 36)</i>	(OFF/IMP/HOLD)
• Endless	When checked, the parameter "test time" gets disabled. The test will run endlessly, until it is aborted by the user. During execution, the test dialog will show the elapsed total test time.	

Switching of measuring range:

Switching the measuring range between 5 and 50 MOhm is achieved by specifying the "R min" parameter:

$$R_{\min} \leq 5 \text{ MOhm} \Rightarrow \text{range } 5 \text{ MOhm}$$

$$R_{\min} > 5 \text{ MOhm} \Rightarrow \text{range } 50 \text{ MOhm}$$

6.3.4 HV: High Voltage Test

With the high voltage test, the electrical strength between the contacted potentials is evaluated.

In case of insufficient or damaged electric strength of the DUT, an arc-over will occur.

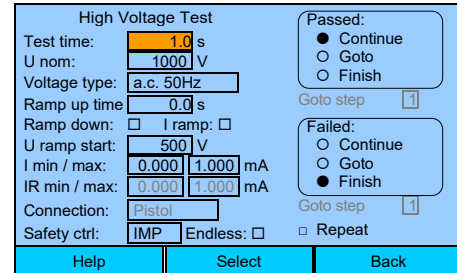

Explanation of test parameters for HV high voltage test:

• Test time	Preset value for duration of test (without ramp time)	(0.1 – 999.9 s)
• U nom	Preset value for test voltage	(100 – 5500 ¹⁾ V [AC] (100 – 6000 ¹⁾ V [DC]
• Voltage type	Sets the kind of test voltage	(AC 50Hz / AC 60Hz / DC)
• Ramp up time	Duration of time for voltage ramp when starting test	(0.0 – 999.9 s)
• Ramp down	Selection of a dropping voltage ramp at end of test	(<input type="checkbox"/> / <input checked="" type="checkbox"/>)
• I ramp	Activates custom current thresholds during voltage ramping	(<input type="checkbox"/> / <input checked="" type="checkbox"/>)
• U ramp start	Initial voltage value at start of voltage ramp	(0V – [U _{nom}])
• I min / max	Required minimum / allowed maximum current for PASS result	(0.000 – 3.000 mA [AC]) (0.000 – 10.000 mA [DC])
• IR min / max	Minimum/maximum allowed current during voltage ramp	(0.000 – 3.000 mA [AC]) (0.000 – 10.000 mA [DC])
• Connection	<i>Unused parameter</i>	<i>(Pistol)</i>
• Safety ctrl	Selection how start signal / ext. protective circuit is to be queried <i>(See 7.3.5 / "Safety control", page 36)</i>	(OFF / IMP / HOLD)
• Endless	When checked, the parameter "test time" gets disabled. The test will run endlessly until aborted by the user. During execution, the test dialog will show the elapsed total test time.	

6.3.5 VT: Visual Test

This test step can be carried out in two different methods: as *Info Step* or as *View Test*.

The Info-step can, for example, be used to give instructions to the operator: "Connect DUT now!".

In case of the visual test, the PASS/ERROR result will depend on the visual judgement of the operator.

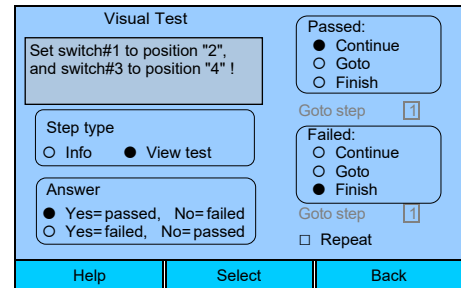

Explanation of test parameters for VT visual test:

<ul style="list-style-type: none"> • Text 	Entry of inquiry or information text
<ul style="list-style-type: none"> • Step type <ul style="list-style-type: none"> ○ Info ○ View test 	<p>Selection of test method:</p> <p>The indicated text is displayed to the operator and can only be acknowledged with OK.</p> <p>There is <u>no</u> test result PASS or ERROR.</p> <p>The indicated inquiry is displayed to the operator and can be answered by YES or NO. Depending on the answer the result of the step will be PASS or ERROR.</p>
<ul style="list-style-type: none"> • Answer <ul style="list-style-type: none"> ○ Yes = pass, No = fail ○ No = pass, Yes = fail 	<p>With this option the evaluation logics can be changed over – since for some questions, "no" in fact is the "good" answer:</p> <p><i>"Is the DUT red hot?"</i> → <i>"No"</i> ⇒ test result PASS.</p>

The input of text is carried out via the keypad. The procedure is in the style used on most cellphones: the keys have multiple assignments, and the different characters are switched one after the other by pressing the same key repeatedly.

6.3.6 I/O-test

By means of the I/O-test it is possible to transmit signals on the I/O-interface, or to read incoming signals. This way external systems can be controlled, or the test process can be controlled dependent on the condition of external systems by branching via the "If-Pass / If-Error" - conditions depending on the read-out result.

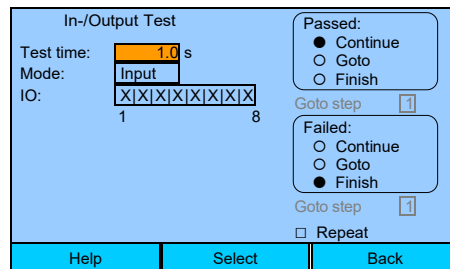

Explanation of test parameters for I/O-test:

<ul style="list-style-type: none"> • Mode: Input <ul style="list-style-type: none"> ○ Test time ○ IO 	Configuration to read signals via I/O-interface Period of time during which the signal input is read Indicates the awaited bit combination on reading	(0.1 – 999.9 s) (0/1/X)
<ul style="list-style-type: none"> • Mode: Output <ul style="list-style-type: none"> ○ Test time ○ IO 	Configuration to set outputs of I/O-interface Waitung time after setting of signals States which outputs are to be set or deleted	(0.1-999.9 s) (0/1/X)

Information:

- For each in- or output "0", "1", or "X" can be specified:
 - 0 – Signal must be (read) "low", resp. will be set to "low"
 - 1 – Signal must be (read) "high", resp. will be set to "high"
 - X – Signal condition is ignored (read), resp. remains unchanged
- When **reading** signals (mode=Input), the specified bit combination must be read exactly from the digital inputs to achieve the test result PASS. Inputs specified with "X" will be ignored.
- After starting test step the space of time of [test time] is awaited. If by process end of test time the specified bit combination has not been achieved, the test result will be FAILED.
- When **setting** signals (mode=Output), all outputs specified with "0" are set on "low" and those specified with "1" are set on "high". The status of outputs specified with "X" will remain unchanged.
- After starting the test step the outputs are set immediately. Then you wait for the space of time [delay] before ending the test step and the next one is started. This can be applied if parts of the controlled external systems will need a certain space of time to convert the signals received.

Note:

The digital outputs 1 to 4 are used to send out status signals (see table in chpt. A-1, p.39). Moreover, the outputs 1 to 4 will be resetted at the end of the IO step. Therefore, digital outputs 1 to 4 can only be used for the running time of the respective IO-step.

7 Additional Functions and Settings

7.1 Single Test

The single test operation is suitable for performing single tests with changing test parameters quickly and easily in sequence. To be able to find, for a new type of DUT, the appropriate test parameter to create a new test programme, the single step operation can be recommended.

Further possibilities for single DUTs could e.g. be special tests or tests for error finding – to create a programme for this purpose alone would be too time-consuming.

7.2 Setting of password

Via the password setting access to the different functions of the device can be limited.

The device S1802M offers two authorisation levels: "User" and " Operator ". The access to different device functions is as follows:

Level	Running tests	Editor	Program List	Single Test
User	✓	—	✓	—
Operator	✓	✓	✓	✓

At factory settings, the device S1802M has no password activated. All operation is done at the "Operator" level, all functions are open and accessible for everyone.

When a password is assigned to the "Operator", then only the functions "Running test programs" and "selecting programs from the list" are freely accessible. All other device functions now can only be accessed by confirmation of the "Operator" password.

The input of the password is carried out as explained in "Input of Characters" on page 18.

If a password is to be reassigned, the current password has to be entered first - for confirmation of authority - before assigning the new one. Without knowledge of the current password an alteration will not be possible.

It is possible to annul the respective password function by assigning a "blank" password. This means, if the "Operator" password is annulled, the device is effectively "free & open to everyone" again.

Upon delivery, password authorisation is not active.

After putting the device into operation, the password for "Operator" should be assigned to avoid unauthorized operation.



7.3 Operation Mode

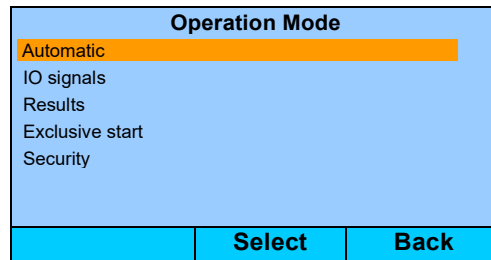

7.3.1 Automatic

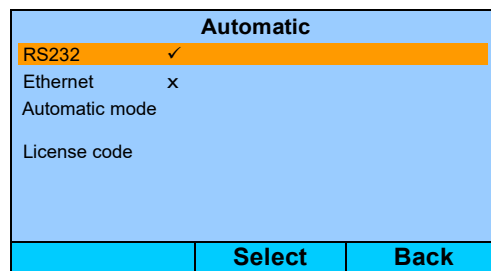

In this menu, the operation mode "Automatic" can be activated. In this mode, the device is controlled by digital commands send over the selected interface type. Available choices are "RS232" and "Ethernet".

Mode "Automatic" must be chosen if the tester is to be operated via DAT3805 remote software.

As soon as operating mode "Automatic" has been acknowledged, S1802M is in remote operation. Manual operation is no longer possible. The device now awaits commands via the active interface (RS232 or ethernet). To exit from automatic mode, the key F3 "Back" must be pressed for a longer time (approx. 3 seconds). Then, a confirmation dialog will be shown, with "yes/no" selection if automatic mode really shall be ended.

License code will open a dialog in which you can enter the registration number for operation with DAT3805 software. (Needed only if you order the DAT3805 software separately. If device S1802M and software DAT3805 are ordered as a bundle, the device is already unlocked.)

7.3.2 IO signals

This option will open another menu, where the usage of certain digital inputs/outputs is defined:

- IN = ✓** : device will use digital inputs 1, 4, 6 and 8 for predefined external input signals. Only inputs 2, 3, 5 and 7 are available for custom usage in test step IO.
- IN = ✗** : the device will not read status signals from X6. The inputs 1 to 7 are available in test step IO.
- OUT = ✓** : device will use digital outputs 1 to 4 to put out status signals during testing. Only outputs 5 to 8 are available for custom usage in test step IO.
- OUT = ✗** : the device will not put out status signals on X6. All outputs 1 to 8 are available in test step IO.

7.3.3 Exclusive start

When checked, then starting of test programs is only possible via HV-pistol start switch, or by closing the external safety circuit (PIN 19 on interface X6).

7.3.4 Results

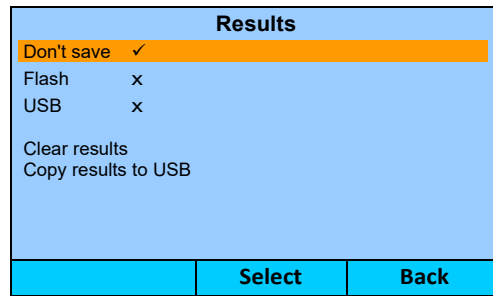

These setting controls if and how the device will save the test results.

In case of "Don't save", the device will only memorize the results of the latest test run. As soon as a new test run is started, the results of the preceding test can't be recalled anymore.

When "Flash" is activated, the result of each completed test run is stored in the internal flash memory.

With "USB" the result of each completed test run is saved to a mass storage device (e.g. USB stick) connected to the USB interface.

When "Clear results" is called, the test results saved in the internal flash memory are deleted. Results saved to USB are not affected.

When calling "Copy results to USB", then all test results stored in the internal flash memory are copied to a USB stick.

Note: required storage space for results saving

Keep in mind that storage capacity of each storage medium is limited. In the device's internal Flash memory, there are up to approx. 180 MB available for results saving. Typical USB sticks of today offer a much bigger capacity.

If the storage capacity of the storage medium is used up, the S1802M will delete/overwrite old saved results, in order to be able to save the current results.
 It is generally recommended to save results externally to USB. Storage to the internal flash memory should only be used as a temporary solution.

The size of a result protocol depends on the number of test steps contained in a test program. Each single test step generates approx. 2kB data in the protocol. For example, an average test program with 10 test steps generates a result protocol of approx. 20kB. Hence, with such a 10-step test program, the following number of test protocols could be saved until old results will start to get overwritten:

- Internal flash memory: 180 MB ⇒ 180k / 20 ≈ 9000 result protocols
- Small USB stick: 1 GB ⇒ 1024k / 20 ≈ 50'000 result protocols
- Typical USB stick: 8 GB ⇒ 8192k / 20 ≈ 400'000 result protocols *)

Note that these are ballpark figures for a 10-step test program, just to give a rough idea about size. Depending on the actually used test programs, those numbers can be significantly larger or smaller.

*) This requires the stick to be formatted with NTFS or exFAT file system. The FAT32 file system does not allow that much files in one folder. (theoretical maximum for FAT32 is 2¹⁶ = 65536 files per folder – in practice usually much less, due to namespace overhead. We recommend to use NTFS or exFAT.)

7.3.5 Security

Via the safety options it is specified which kind of safety control is to be applied.

This menu contains the sub-menus "HV/IS" and "FT/LC". This offers the possibility to use different safety controls for function test & leakage current test than for the HV- & IS-tests.

The parameters in both sub-menus are exactly the same.

Available parameters:

- **Start button** Test process is started via "Start" key on the tester's front panel
 - **Probe button** Test process is started via start key of the test probe
 - **Pistol** Test process is started via start key of the test pistol
-
- **Other Input** Test process is started via a signal on the I/O-interface:
 - **Foot switch** } The chosen option will only change the messages shown on the display ("Press 2-hand-control!", "Open Test Hood", etc.)
 - **2-hand** } From the device's point of view, they are "all the same" – the important point is the digital input, on which the signal of the external control is received:
 - **Cover (test hood)** }
 - **Test Button** }
 - **Digital input** Specifies by which digital input (1–16) the start signal is committed:
 - 1-8 = inputs 1 .. 8 at IO-interface (see annex A-1, p. 39)
 - 9 = START-button on the front panel
 - 10 = Start-button of PE probe
 - 13 = HV safety-circuit is active (PIN 19 of IO-interface)
 - 14 = Start signal of HV pistols

(Inputs 11, 12, 15, 16 are not useable for this purpose)
 - **Check release** When to check for the safety-control signal being released again:
 - **After each step** Display a "release signal"-message after each step
 - **After program** Display a "release signal"-message only at the end of a test program

"Safety control":

If within the test steps IS/HV or FT/LC the option "safety control" is *not* set to "**Off**", then a respective message is displayed after starting a test step (e.g. "push start key"). The test step will only start if the request has been complied with, i.e. if the electric circuit is closed via the respective safety control.

The possible settings for "safety control" in test steps HV and IS:

- Off** – Test step starts immediately, without checking the protective circuit.
- Impulse** – Test will start after closing protective circuit once.
- Hold** – Protective circuit has to remain closed during the complete duration of the test until the test result will be displayed. Premature release of contact will lead to abortion of the test step with the result ERROR.

"Check release":

If "Check release" is set to "**After each Step**", then at the end of a test step a prompt to release the safety control will be displayed. (Applies only if the test step uses "Safety ctrl = hold".)

If "Check release" is set to "**After program**", then the prompt to release the safety control will be displayed only at the end of a test program. (E.g. when using a test hood.)

7.4 Menu / "Setting"

7.4.1 Interface: Ethernet

The ethernet interface primarily is used to integrate the tester into a network. However, "remote control" operation can be performed using this interface, too.







Ethernet				
IP	192.168.99.254			
SM	255.255.255.0			
GW	10.10.5.1			
Print IP	192.168.99.16			
Print Port	9100			
<table border="1"> <tr> <td style="width: 50%;"></td> <td style="width: 25%; text-align: center;">Select</td> <td style="width: 25%; text-align: center;">Back</td> </tr> </table>			Select	Back
	Select	Back		

- IP address** "Address" of tester in the network, format "xxx.xxx.xxx.xxx". This IP has to be assigned to each tester locally and has to be non-recurrent in the network.
- Subnet mask (SM)** When applying sub networks, this mask determines which parts of the IP-address contain the network-ID (identification: "255") and which contain the host-ID (identification: "0"). (default: 255.255.255.0)
- Gateway (GW)** If there are more than one network connected in the local Ethernet via a gateway then the IP of the gateway must be entered here (format "xxx.xxx.xxx.xxx")
- Printer IP** "Address" of a network printer, format "xxx.xxx.xxx.xxx".
The printer must be PostScript compatible.
- Printer port** Sets the "channel" to use for communication with the network printer.

7.4.2 Buzzer

With this parameter you can activate or deactivate the signal sounds of the device.

7.4.3 Language

Choose Language				
	Ceština			
	Deutsch			
	English			
	Francais			
	Italiano			
	Nederlandse			
<table border="1"> <tr> <td style="width: 50%;"></td> <td style="width: 25%; text-align: center;">Select</td> <td style="width: 25%; text-align: center;">Back</td> </tr> </table>			Select	Back
	Select	Back		

Here you can set the language for screen display. Use the up/down arrow keys to select the desired language from the list. Then push F2 "Select" to change the language.

7.4.4 Setting of date and time

System Date / Time		
Date (M/d/yyyy)		
11/12/2013		
Time (h:mm AP)		
12:34 PM		
	Select	Back

The values in the active field can be changed with the up/down arrow keys. Alternatively, you can enter the values by entering the numbers directly. With the left/right arrow keys, you can go forward/backward with the active field.

7.4.5 Factory reset

Using this function, the device will be resetted to factory settings.

Attention: All custom test programs will be deleted.

7.5 Info

In this menu, general information about the device's hardware and software is shown:

Device Info		
Kernel version: #116 Mon Mar 19 13:50:06 CET 2012		
Firmware version: 1.3.1		
Device serial: 0815-4711		
Generator info	Close	

Generator Info		
Name:	HVG18/10	
Version: Hardware:	1.0.9	
Vendor ID:	0x0	
Product Code:	0x0	
Revision number:	0x0	
Software:	1.0.6	
Serial:	0x0	
Date/Time:	11.12.2013 12:34	
Frequency (Hz):	50	
Device info	Close	

Via the button [F1], you can switch between Device info and Generator info.

Annex

A Interface Configuration

A-1 External I/O Interface X6

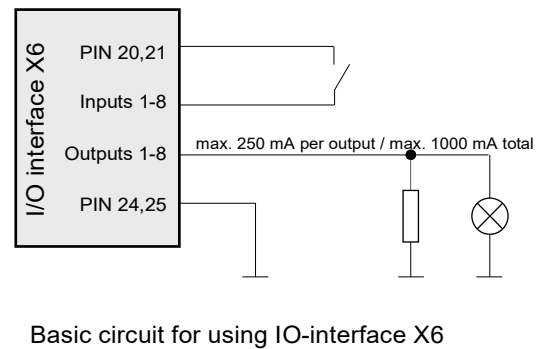
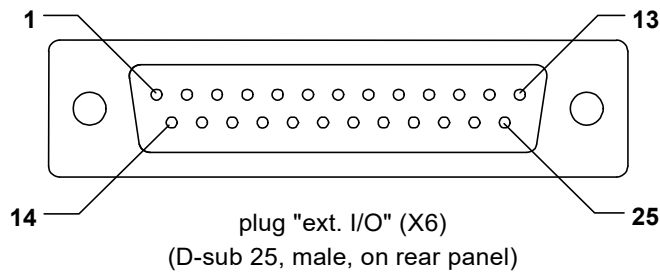

PIN	description	configuration
1	output 1	<i>free / EXT_PASS **)</i>
2	output 2	<i>free / EXT_FAIL **)</i>
3	output 3	<i>free / EXT_BUZZER **)</i>
4	output 4	<i>free / EXT_TEST **)</i>
5	output 5	<i>free</i>
6	output 6	<i>free</i>
7	output 7	<i>free</i>
8	output 8	<i>free</i>
9	<i>n.a.</i>	<i>not used</i>
10	<i>n.a.</i>	<i>not used</i>
11	input 1	<i>free / EXT_YES **)</i>
12	input 2	<i>free</i>
13	input 3	<i>free</i>
14	input 4	<i>free / EXT_NO **)</i>
15	input 5	<i>free</i>
16	input 6	<i>free / EXT_ACK **)</i>
17	input 7	<i>free</i>
18	input 8	EXT_START
19	input SK	EXT_SK
20	+24 V DC *)	int. voltage against ground *)
21	+24 V DC *)	int. voltage against ground *)
22	<i>n.a.</i>	<i>not used</i>
23	<i>n.a.</i>	<i>not used</i>
24	GND	grounding
25	GND	grounding

*) internal 24V supply, do **NOT** feed in from external

**) The configuration of digital inputs and outputs is depending on the setting in:
Settings / Operation Mode / Status IO. (See chpt. 7.3.2, page 34.)

A-2 Rear connectors for test voltages

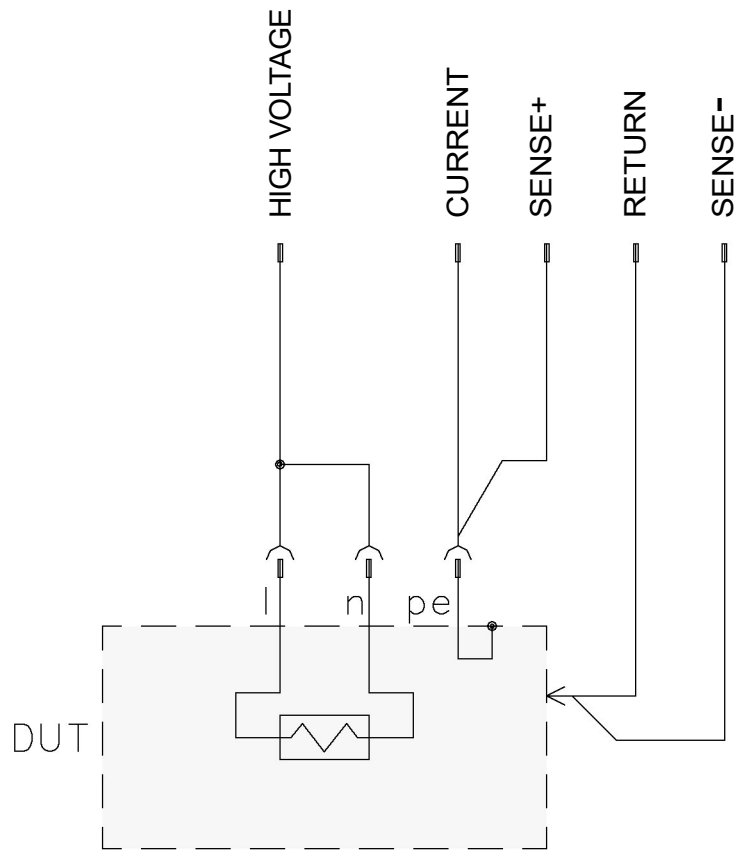

B USB devices, and "Testing with High Voltage"

- When testing with high voltage, a failing testpiece can be the cause for electromagnetic radiation (because of voltage arc-over at the weak point in the testpiece), and the resulting sparking can cause EM radiation of high frequencies. This radiation gets emitted by the test lines – antenna principle – , and may get received again by USB lines in the closer surrounding.
- USB controllers are generally vulnerable to stray fields of high frequencies, and thus the communication with USB can get interrupted. In particular, it is possible that short occurrences of stray fields put the USB-controller into a persistent inoperable state, so that USB communication keeps being interrupted.
- If such an USB malfunction occurs, often it is already sufficient to just unplug the USB cable, and plug it in again after a few seconds. If the malfunction still persists, it is needed to switch the affected devices off, and on again.

Concerned Situations and devices:

- generally every kind of PC or similar device that is using a USB connection, and is located in very close neighborhood to a test with high voltage.
- in particular such PCs that are using DAT3800 or DAT3805 software to control a testing device, and are using an USB connection to the test device.
- also test devices of series 3800 or 1800, when they are themselves using external USB devices, like e.g. USB keyboard, USB sticks for data exchange, etc.

Measures to avoid failures

- as far as possible, it is recommended to keep a sufficiently large distance between USB cables/devices, and testpiece / testing lines. (Recommended are at least 30cm, the practical rule is "the more, the better".)
- it is recommended to use well-shielded USB cables with ferrite-core coil.
(On its own this won't eliminate the possibility of errors, but it generally reduces sensitivity against stray fields, and makes occurrence of errors less likely.)

C Troubleshooting

If the device is signalling one of the following error messages:

- ♦ *"No answer from generator"*
- ♦ *"No operating status from generator"*
- ♦ *"No communication to generator"*
- ♦ *"24V supply damaged"*

In case of any of these errors, please restart the device at least one time, i.e. switch the device off and on again. Usually there is no problem with the hardware, and the error will be gone after restart.

If the error still persists, please contact the service of SPS electronic GmbH.

EU-Konformitätserklärung

EU Declaration of Conformity

EU Déclaration de Conformité

Wir / We / Nous:

SPS electronic GmbH
True German Quality
Eugen-Bolz-Str. 8
74523 Schwäbisch Hall - Germany

erklären hiermit, dass das nachfolgende genannte Gerät den einschlägigen grundlegenden Sicherheitsforderungen der EU-Richtlinien entspricht.

declare, that the following unit complies with all essential safety requirements of the EU Directives.

Déclarons que le produit désigné ci-dessous est conforme aux exigences de sécurité des Directives EU.

Geräteart:
Description of device:

Sicherheitstester
Safety Tester

Typ / Type:

S 1802M

EU Richtlinien / EU Directives / Directives EU:



EG Maschinenrichtlinie 2006/42/EG mit Änderungen
EC Directive for machinery 2006/42/EC with amendments
Normes CE machines 2006/42/EC avec amendements



EU Niederspannungsrichtlinie 2014/35/EU
EU Directive for low voltage 2014/35/EU
Normes CE basse tension 2014/35/EU



EU Richtlinie Elektromagnetische Verträglichkeit 2014/30/EU mit Änderungen
EU Directive electromagnetic compatibility 2014/30/EU with amendments
Normes électromagnétiques CE compatibles 2014/30/EU avec amendements



RoHS-Richtlinie 2015/863/EU (RoHS III)
RoHS directive 2015/863/EU (RoHS III)
Directive RoHS 2015/863/UE (RoHS III)

Angewandte harmonisierte Normen / Applicable harmonized standards / Normes Européennes harmonisées:

- EN 61 000-3-2:2019-12; EN 61 000-3-3: 2020-7 ; EN 61326:2013-07; EN 50 191:2011-10
- DIN EN ISO 12100:2011-03

Angewandte nationale Normen und technische Spezifikationen / Applicable national standards and technical specifications:
Normes nationales et spécifications techniques particulières:

- ---

16.02.2026

Datum / date / date

SPS electronic
SPS electronic GmbH
Eugen-Bolz-Str. 8 · 74523 Schwäbisch Hall
Tel.: +49 791 20 212 0 · info@sps-electronic.com

Dipl. Ing. Johannes Geyer

Dieser Konformitätserklärung unterliegt grundsätzlich nur das von uns gelieferte oder in Betrieb genommene Gerät. Für Änderungen und Erweiterungen ist der Betreiber verantwortlich und damit für die Sicherstellung der Übereinstimmung der veränderten Anlage mit den betreffenden EU-Richtlinien.

This declaration of conformity is only subject to the device as it was delivered or commissioned by us. Any subsequent alterations and extensions are in the responsibility of the operator, and he therefore has to ensure the altered unit complies with the corresponding EU directives.

Cette déclaration de conformité se réfère uniquement à l'appareil que nous avons livré ou mis en service. L'utilisateur est responsable des changements ultérieurs et des extensions et doit donc s'assurer que l'unité change respecte les directives CE correspondantes.