

BROCHURE

# Power Meters and Power Sensors

High Performance Solutions for Peak  
and Average Power Measurements



## Table of Contents

Introducing Keysight Power Meters and Sensors .....	3
Peak Power Measurements and Analysis for Wireless Applications and High-Test Throughput .....	4
U2040 & U/L2050/60 X-Series sensors settings for wireless tests .....	7
Peak and Average Power Measurements and Analysis for Radar and Wireless Applications .....	8
Portable solution for base station installation and maintenance .....	10
Peak and Average Power Measurements for Compact ATE Systems .....	11
Peak and Average Power Measurements for Effective Capture of Wireless and Radar Signals .....	13
High sampling rate for WiMAX and WLAN testing .....	14
Peak and Average Power Measurements for Testing of Wireless Signals .....	16
Average Power Measurements for Metrology and Calibration Laboratories .....	19
Average Power Measurements for Flexible Testing: On the Rack and On the Go .....	20
Average Power Measurements for Mobile Testing that's Plug-and-Play Easy .....	21
Average Power Measurements for Broadband Applications .....	24
Average Power Measurements for mmWave applications .....	26
Average Power Measurements for Portable RF Measurements .....	27
N1913PM5B VDI Erickson PM5B MM-Wave Power Meter .....	28
Power Measurement Software for Simplified Data Capture .....	28
Power Meters Selection Chart .....	31
Power Sensors Selection Chart .....	34
Power Meters and Sensors Compatibility Table .....	35
Free Power Measurement Hints and Tips .....	37

## Introducing Keysight Power Meters and Sensors

### Reliable, high-performing solutions

Every power meter and sensor from Keysight Technologies, Inc. consistently delivers great results.

### One specific application: One right solution

Keysight offers a wide selection of power meters and sensors for practically all application needs—wireless communications, radar pulse measurements, component test and more.

### A sure investment for many years to come

Code-compatibility between power meters reduces the need for re-coding. Not only that, all Keysight power meters are backward-compatible with most legacy power sensors.

### Global network support

No matter where you are, Keysight is committed to giving you the 24-hour support you need regarding our products, applications, or services.



# Peak Power Measurements and Analysis for Wireless Applications and High-Test Throughput

## Keysight U2040 & U/L2050/60 X-Series USB/LAN Wide Dynamic Range Power Sensors

Accurately measure any modulated signal with the U2040 & U/L2050/60 X-Series USB/LAN power sensors. With LAN or USB connectivity, the U2040 & U/L2050/60 X-Series sensors come with the world's widest dynamic range in a power sensor, covering a range of -70 to +20/26 dBm. The U2049XA and L2065XT LAN power sensors comes with a thermal vacuum option, and it gives the same accuracy and performance even in thermal vacuum chambers.



### Features

#### Models

- U2041/43XA USB wide dynamic range average power sensor (10 MHz to 6/18 GHz; -70 dBm to +26 dBm)
- U2042/44XA USB peak and average power sensor (10 MHz to 6/18 GHz; -70 dBm to +26 dBm)
- U2049XA LAN wide dynamic range power sensor (10 MHz to 33 GHz; -70 dBm to +20 dBm)
- U2051/52/53/54/55XA USB wide dynamic range average power sensor (10 MHz to 6/18/33/40/50/53<sup>1</sup> GHz; -70 dBm to +20/+26 dBm)
- U2061/62/63/64/65XA USB wide dynamic peak and average power sensor (10 MHz to 6/18/33/40/50/53<sup>1</sup> GHz; -70 dBm to +20/+26 dBm)
- L2051/52/53/54/55XA LAN wide dynamic range average power sensor (10 MHz to 6/18/33/40/50/53<sup>1</sup> GHz; -70 dBm to +20/+26 dBm)
- L2061/62/63/64/65XA LAN wide dynamic peak and average power sensor (10 MHz to 6/18/33/40/50/53<sup>1</sup> GHz; -70 dBm to +20/+26 dBm)
- L2065XT LAN TVAC wide dynamic range power sensor (10 MHz to 53 GHz; -70 dBm to +20 dBm)

#### Specifications

- 20 Msamples/second sampling rate
- 5 MHz Video Bandwidth
- Measurement speed: 50,000 readings/second (fast/buffered mode)
- Variable sampling rate up to 1 Msamples/second and long memory acquisition up to 1 Mbytes (applicable for U/L2060 X-Series peak and average power sensors only)

1. Freq up to 53GHz is only applicable to USB/LAN U/L2055/65 Series with option 053.



#### Highlights

- The world's widest dynamic range in a power sensor, spanning -70 to +26 dBm
- Fast measurement speed at 50,000 readings/second (fast/buffered mode)
- Average mode time selectivity feature allows the sensor to make both average and time-gated average measurements across the full 96 dB range
- Capture and analyze measurements with the intuitive BenchVue software
- Thermal vacuum option for LAN sensor



## Measurement type

- Peak, min, average, and peak-to-average ratio power measurements
- Time-gated and free-run measurement modes
- Automatic rise time, fall time, pulse width, pulse period, duty cycle, time to positive occurrence, and time to negative occurrence time measurements

## Calibration

- Internal zeroing and calibration

## Remote programmability

- SCPI standard interface commands

## Typical test setup for wireless chipset manufacturing test

Three power sensors are used to measure the chipset's input power, output power, and reflected power. A spectrum analyzer, like the Keysight Technologies MXA, is used to measure other critical parameters such as ACPR, EVM, and harmonics. Care should be taken to ensure that the power to be measured does not exceed the sensor's measurable power range to avoid damaging the sensor, particularly at the power amplifier's output. Depending on the signal formats, a trigger output signal from the signal source can be connected to the trigger input ports of the power sensors to synchronize the signal timing and sensors' measurement acquisitions.

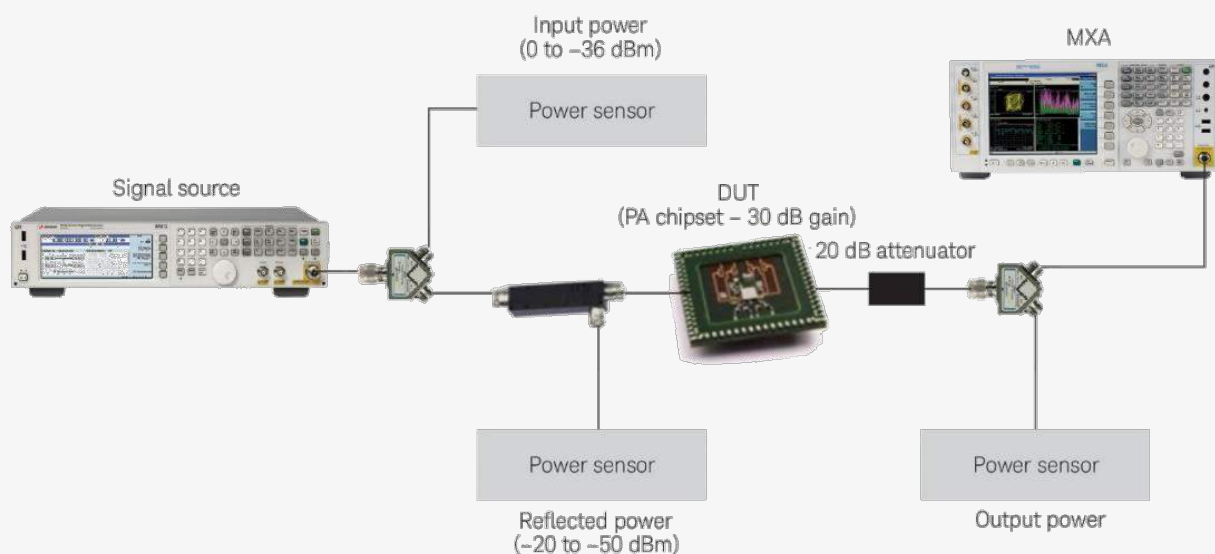

## Average mode time-selective measurement

The average mode time-selectivity feature allows you to precisely select when a measurement is made. A measurement aperture is used to define the duration of the measurement and its position in time can be set relative to a trigger. The aperture duration can be set from 20  $\mu$ s to 200 ms with a resolution of 100 ns to be able to cover any radio format. Giving you similar ability to define a measurement as time-gated power measurements in peak mode, this function allows you to control which portion of the waveform is measured, and perform precise time-selective average power measurements across the full 96 dB dynamic range, and real time measurements of up to 50,000 readings per second.

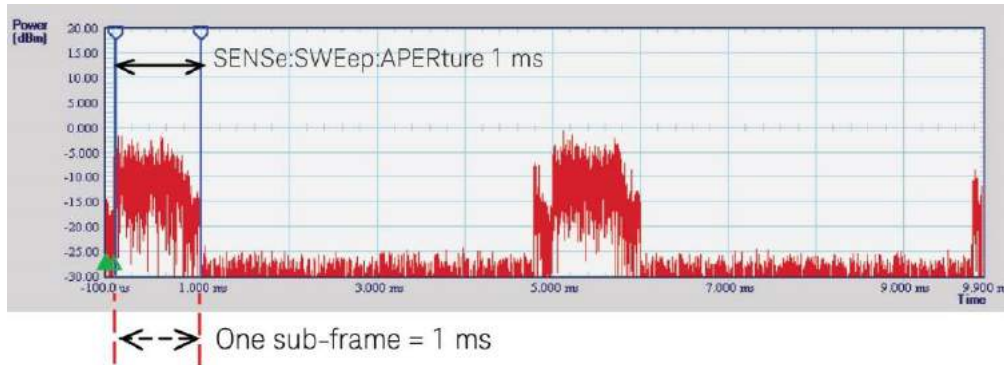

Measurement results for one 1 ms LTE sub-frame using burst average power setting.

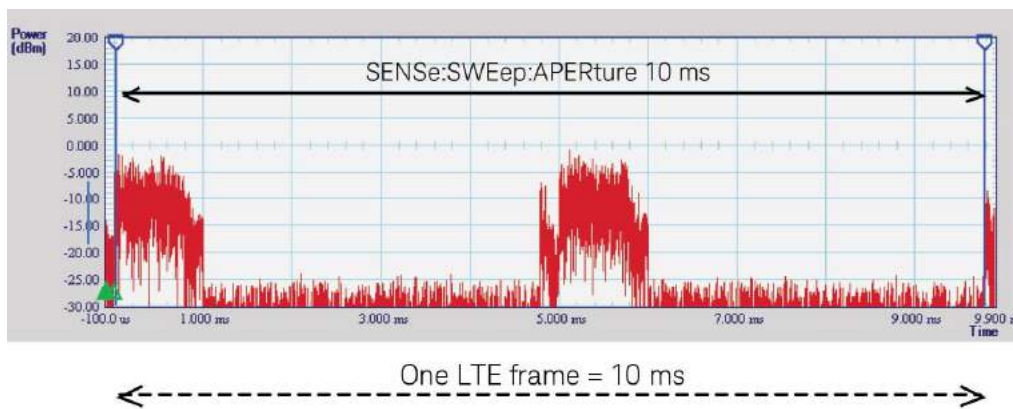

Measurement of one LTE frame over 10 ms using waveform average power setting.



## U2040 & U/L2050/60 X-Series sensors settings for wireless tests

To achieve the most accurate and fastest measurements, the U2040 & U/L2050/50 X-Series sensors can be configured into different modes based on the signal formats. The following table lists the common wireless signal formats and the recommended sensor settings.

Type of measurement	Signals	Recommend sensor settings
Burst average power for signals with burst/frame structure	LTE-TDD, GSM, EDGE, WLAN	Average mode time-selectivity
Waveform average power for signals with burst/frame structure	LTE-TDD, GSM, EDGE, WLAN	Average mode time-selectivity
Waveform average power for continuous modulated signals	W-CDMA, LTE-FDD	Free run, fast mode
Time slotted signals without external trigger signals	GSM, EDGE	Normal mode time-gated power measurement
Time slotted signals with external trigger signals	GSM, EDGE	Normal mode time-gated power measurement, or Average mode time-selectivity



# Peak and Average Power Measurements and Analysis for Radar and Wireless Applications

## Keysight U2020 X-Series USB peak and average power sensors

The U2021XA and U2022XA X-Series USB peak power sensors are designed to carry out high speed peak and average power measurements. These sensors offer a fast measurement speed of > 25,000 readings/second and a wide peak power dynamic range of -30 to +20 dBm, providing the peak power measurement capability of a power meter in a compact, portable form.



## Features

### Models

- U2021XA X-series USB peak and average power sensor, 50 MHz to 18 GHz
- U2022XA X-series USB peak and average power sensor, 50 MHz to 40/50 GHz

### Specifications

- Frequency range of 50 MHz to 18 GHz/40/50 GHz
- -45 to +20 dBm in average mode/-30 to +20 dBm in peak/gated mode
- 80 Msamples/sec sampling rate
- 30 MHz video bandwidth
- > 25,000 readings/s measurement speed (in buffer mode)

### Measurement type

- Peak, min, average, and peak-to-average ratio power measurements
- Time-gated and free-run measurement modes
- Automatic rise time, fall time, pulse width, pulse period, duty cycle, time to positive occurrence, and time to negative occurrence time measurements
- CCDF statistical analysis

### Calibration

- Internal zeroing and calibration

### Remote programmability

- USB interface



### Highlights

- Fast measurement speed of > 25,000 readings/second (in buffer mode)
- Wide peak power range of 50 dB, ranging from -35 dBm to +20 dBm
- Fast rise/fall time of down to 13 nano seconds and a video bandwidth of 30 MHz
- Standalone peak power measurement capability without the need of a power meter
- Built-in trigger in/trigger out function
- Built-in radar and wireless presets





## High throughput wireless test systems with up to 20 channels

The U2020 X-series USB peak and average sensors perform fast and accurate peak and gated power measurements. These measurements are essential aspects of the production tests conducted for wireless signals used in cellular/mobile phone handset, wireless chipset and amplifier applications. With plug-and-play USB connectivity, high measurement speed and multichannel capability, setting up a high throughput test system is simple, fast, and cost effective.

Typical test set up for LTE/WiMAX/WiFi test systems to test handset, PC card, chipset, amplifier with the U2020 X-Series sensor

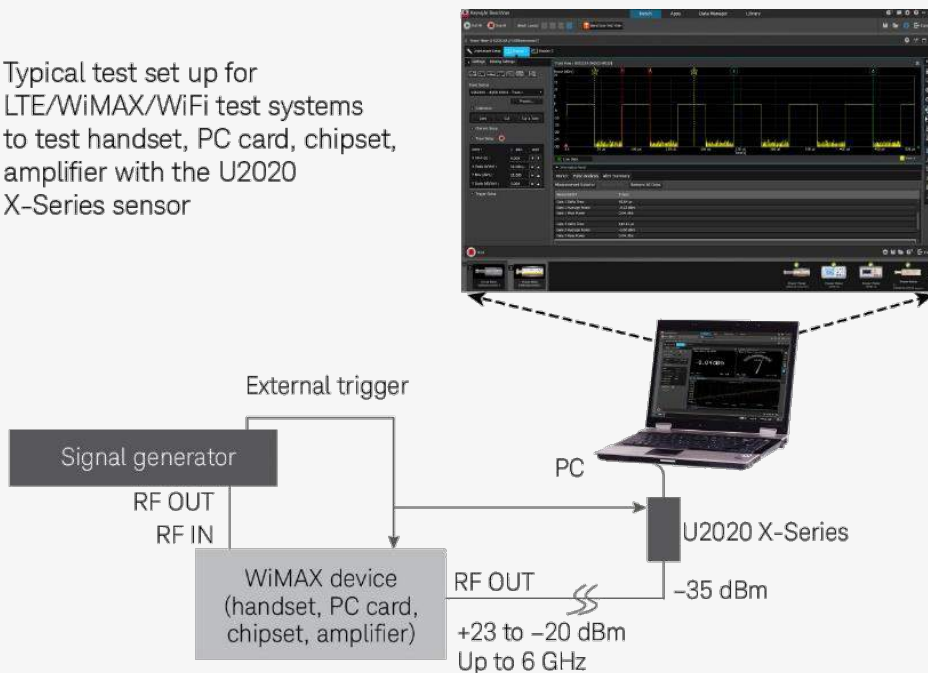

## Remote testing for radar installation and maintenance

When a U2020 X-series sensor is connected to a LAN-USB adapter, you can perform complex radar pulse analysis and monitor your measurements from a distance up to 200 feet. The built-in internal zero calibration function allows you to permanently connect your sensor to the device-under-test without the hassle of constantly removing and re-installing your sensor.



Long distance pulse parameter measurements

Radar antenna tower

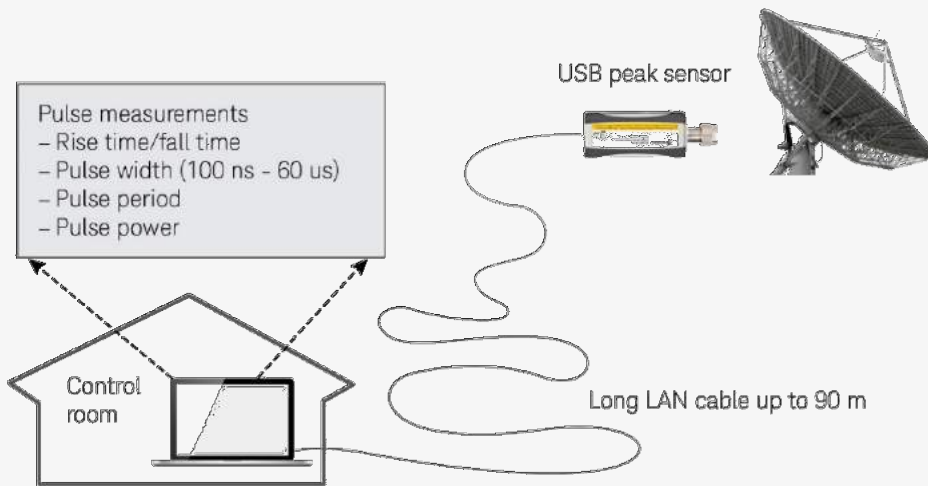

## Portable solution for base station installation and maintenance

Portability is one of the key attributes in the base station installation and maintenance industry, where users mainly work out in the field. Whether you are using a PC or other Keysight instruments, the U2020 X-series USB power sensors will perform peak and average power measurement similar to traditional power meters, all in a portable and lightweight form factor.



Cellular base station

Portable and lightweight solution for cellular base station maintenance



# Peak and Average Power Measurements for Compact ATE Systems

## Keysight N8262A P-Series modular power meter

The N8262A is a dual-channel, LXI Class C compliant power meter that's designed to support LAN-based ATE systems. With its slim, half-rack build, the N8262A enables a smaller test system and ensures easier deployment.



### Features

#### Dimension

- 1U half-rack size

#### Specifications

- 30 MHz video bandwidth
- 100 Msamples/s continuous sampling rate

#### Measurement type

- Peak, average, peak-to-average ratio power measurements
- Time-gated and free-run measurement modes
- CCDF statistical analysis
- Rise time, fall time, pulse width, time to positive occurrence and time to negative occurrence measurements
- Includes predefined configurations for WLAN, radar and MCPA

#### Calibration

- Calibration and correction factors in EEPROM (P-Series, E-Series sensors)
- Internal zeroing and calibration (P-Series sensors) \* *Refer to page 18*

#### Remote programmability

- SCPI standard interface command  
\* *Also programmable in other languages. See "System-ready software" below.*
- 10/100BaseT LAN interface

#### System-ready software

- Bundled Synthetic Instrument Finder works with all LXI-compliant instruments
- Instrument Web page is accessible with any standard Web browser
- Bundled Power Meter GUI is also compatible with P-Series power meters
- Bundled IVI driver enables programming in your choice of environment, including Keysight VEE, LabVIEW, C, C#, C++, Microsoft Visual Basic, and MATLAB



#### Highlights

- Deploy test systems more easily
- Lower test system startup cost
- Integrate easily into existing systems
- Perform remote access and control from anywhere



## Backward-compatibility

- Code-compatible with N1912A P-Series power meter

## Deploy test systems more easily

With its 1U half-rack size, the N8262A eases deployment of test systems wherever duty calls.

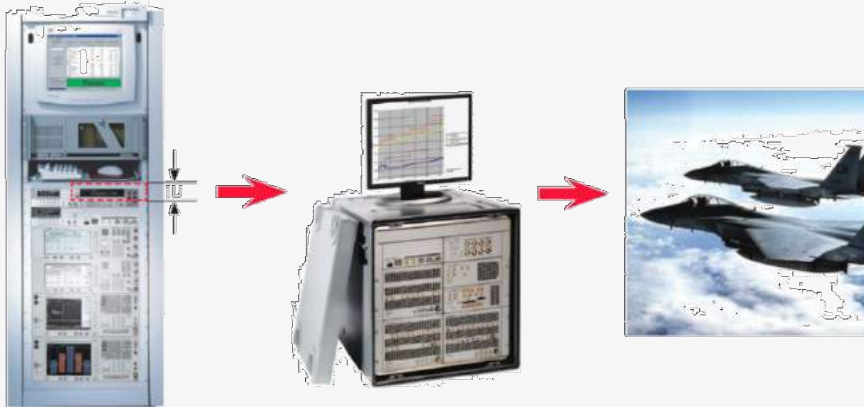

Smaller test systems are possible with the 1U N8262A, making it more readily deployable

## Remote access and control from anywhere

With the convenience of LAN, neither place nor distance is a limit to power measurements with the N8262A.



Whenever you need to view or modify an N8262A's current proxy setting, you can do so with its built-in Web page.

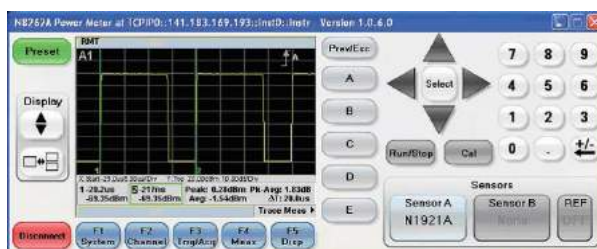

Control an N8262A and view measurement results through the Power Meter GUI soft front panel, the way you would a P-Series power meter from its front panel.



# Peak and Average Power Measurements for Effective Capture of Wireless and Radar Signals

## Keysight N1911A/12A P-Series power meters

The P-Series power meters are LXI Class C compliant, designed for high performance measurement of wireless signals such as WiMAX™, LTE and radar. Predefined settings in the P-Series power meters enable effective capture of unpredictable wireless signals, with their high burst rates and fast, time-varying power levels.



## Features

### Models

- Single-channel N1911A
- Dual-channel N1912A

### Specifications

- 30 MHz video bandwidth
- 100 Msamples/s continuous sampling rate

### Measurement type

- Peak, average, peak-to-average ratio power measurements
- Time-gated and free-run measurement modes
- CCDF statistical analysis in graphical and tabular formats
- Rise time, fall time, pulse width, time to positive occurrence and time to negative occurrence measurements
- Includes predefined configurations for wireless communication formats such as LTE

### Calibration

- Calibration and correction factors in EEPROM (P-Series, E-Series sensors, and N8480 Series)
- Internal zeroing and calibration (P-Series sensors)

### Remote programmability

- SCPI standard interface commands  
*\* Also programmable in other languages. See below*
- GPIB, LAN and USB interfaces

### System-ready software

- Bundled IVI driver enables programming via your choice of environment, including Keysight VEE, LabVIEW, LabWindows, C, C++, and MATLAB



### Highlights

- Quick setup with 22 radio presets
- Automatic pulse capture
- Wide VBW and high sampling rate
- High resolution color display
- External triggerable when used with E-Series average power sensors



## Backward-compatibility

- Code-compatible with EPM-P and EPM Series power meters

## High sampling rate for WiMAX and WLAN testing

Apart from WiMAX and WLAN presets, the P-Series power meters also offer 100 Msamples/s continuous sampling that ensures glitches are not missed.

- The P-Series power meters' 30 MHz video bandwidth enables the capture of signals with modulation bandwidth up to 30 MHz
- With their auto trigger hold-off capability, you can capture the complete Downlink or Uplink subframe burst desired within a fixed time span
- Time-gated peak, average and peak-to-average ratio power measurements are automatically displayed to ease analysis of signals

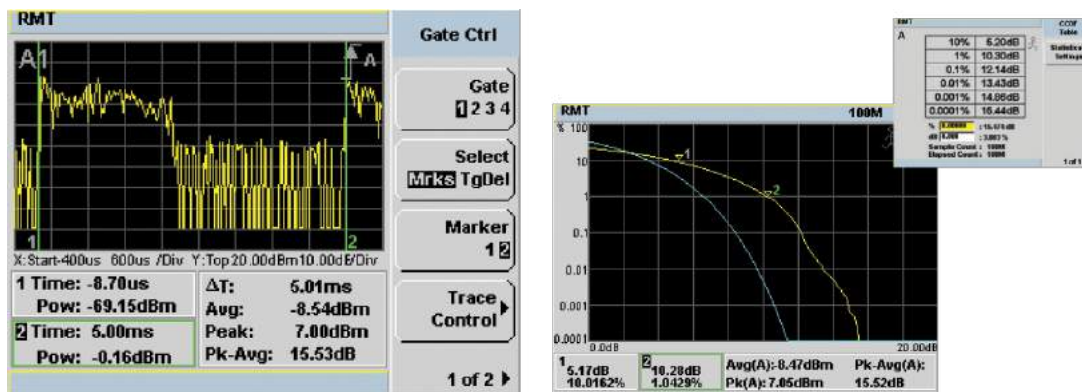

CCDF statistical analysis is viewable in both tabular and graphical formats

## Autoscaling and autogating for radar testing

Setting up for radar signal measurements is faster and easier with the P-Series preset. Capture of a radar pulse is further simplified with autoscaling and auto gating functions. With auto gating set to "perpetually on," the gates reposition themselves automatically when pulse width changes.

- Up to four independent time gates can be set for individual measurements on one or multiple pulses
- With a frequency range of up to 40/50 GHz and rise/fall times of  $\leq 13$  ns, you have more than enough to profile high-frequency radar signals in most applications

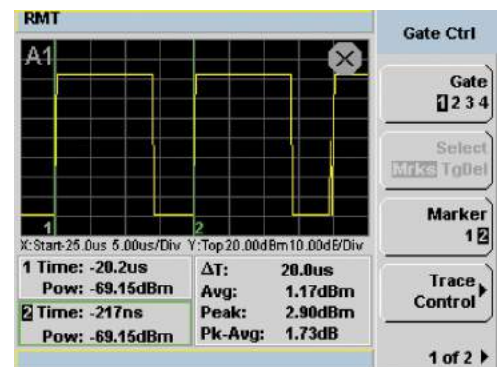

## Wide video bandwidth for MCPA testing

In designing multi-carrier power amplifiers (MCPA), a wide-bandwidth power meter such as the P-Series helps you ensure that your device stays within its maximum power specification. The P-Series power meter's 30 MHz video bandwidth allows up to six 3G carriers over a wide dynamic range.

- CCDF and peak-to-average power measurements verify if MCPA is clipping
- 100 MSamples/s continuous sampling ensures easier detection of glitches
- Rise/fall time measurements help in checking the signal's burst profile and in identifying power transition problems
- High resolution color display ease viewing and differentiation of the four traces

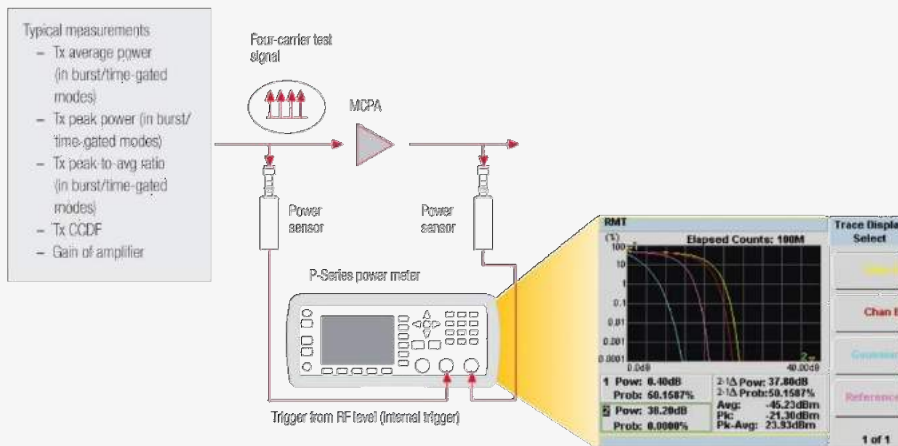

### A sample setup for MCPA testing

**i** The P-Series power sensors' internal zeroing and calibration

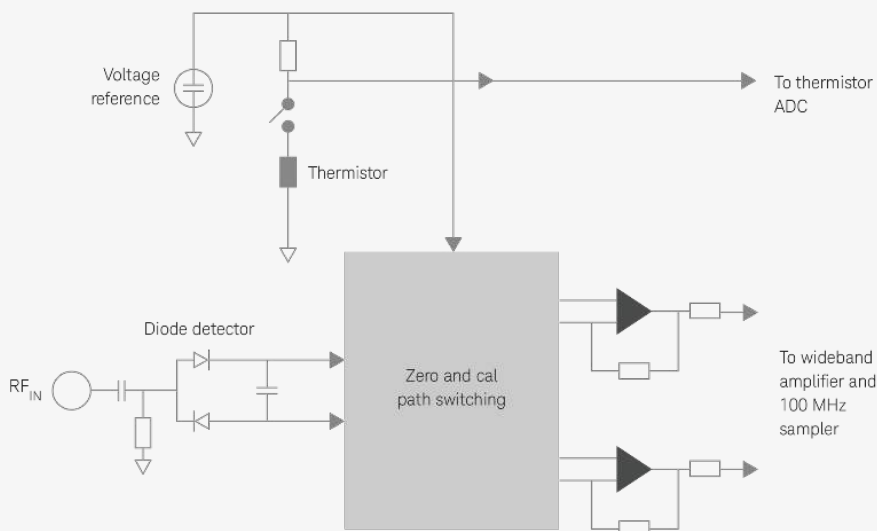

- Integrates DC reference source and switching circuits into sensor
- Eliminates the need for calibration with an external reference source
- Eliminates the need to connect/disconnect from calibration source and test fixtures
- Reduces test times, measurement uncertainty and wear-and-tear on connectors

## Peak and Average Power Measurements for Testing of Wireless Signals

### Keysight E4416A/17A EPM-P Series power meters

The EPM-P Series power meters operate with the E9320 Series peak-and-average power sensors for testing various complex modulation formats in wireless communication systems, such as TDMA and CDMA.



### Features

#### Models

- Single-channel E4416A
- Dual-channel E4417A

#### Specifications

- 5 MHz video bandwidth
- 20 Msamples/s continuous sampling rate

#### Measurement type

- Peak, average, peak-to-average ratio power measurements
- Time-gated and free-run measurement modes
- Includes predefined configurations for GSM, EDGE, NADC, iDEN, Bluetooth®, IS-95 CDMA, W-CDMA and cdma2000®

#### Calibration

- Calibration and correction factors in EEPROM (E-Series sensors and N8480 Series)

#### Remote programmability

- SCPI standard interface commands
- GPIB, RS-232/422 interfaces

#### System-ready software

- EPM-P analyzer software backward-compatibility
- Code-compatible with EPM Series power meters



#### Highlights

- Optimize dynamic range for peak power measurement
- Complete TDMA and CDMA characterization





## Optimize dynamic range with E9320 Series sensors

Wider bandwidths allow you to profile fast-changing signals, but at the expense of dynamic range. That's why each E9320 Series power sensor comes with three variable bandwidth settings. This helps you select the best bandwidth for your application, yet still maintain the widest possible dynamic range.

Sensor model	Video bandwidth/maximum peak power dynamic range			
	Off	High	Medium	Low
E9321A E9325A	300 kHz/−40 dBm to +20 dBm	300 kHz/−42 dBm to +20 dBm	100 kHz/−43 dBm to +20 dBm	30 kHz/−45 dBm to +20 dBm
E9322A E9326A	1.5 MHz/−36 dBm to +20 dBm	1.5 MHz/−37 dBm to +20 dBm	300 kHz/−38 dBm to +20 dBm	100 kHz/−39 dBm to +20 dBm
E9323A E9327A	5 MHz/−32 dBm to +20 dBm	5 MHz/−32 dBm to +20 dBm	1.5 MHz/−34 dBm to +20 dBm	300 kHz/−36 dBm to +20 dBm

## Complete TDMA/CDMA analysis with bundled analyzer software

### Pulse analysis

Versatile markers offer complete power and timing characterization of pulsed signals, to provide easy testing of TDMA component parameters and system performance. In addition to measuring peak, average and peak-to-average ratio power, the Keysight EPM-P analyzer software measures the following pulse characteristics automatically:

- Power: pulse top, pulse base, distal, mesial, proximal, overshoot and burst average
- Frequency and time: Pulse Repetition Frequency (PRF), Pulse Repetition Interval (PRI), pulse width, off-time, rise time and fall time

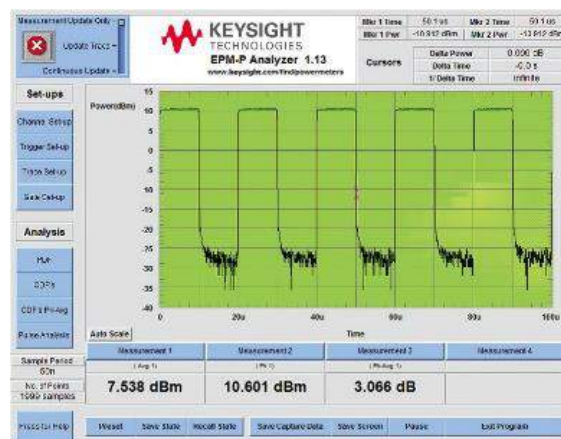

### Statistical analysis

For today's noise-like CDMA and W-CDMA formats, statistical analysis of the power distribution helps you optimize system design by providing essential characterizations such as amplifier compression. The Keysight EPM-P analyzer software provides the capability to determine the PDF, CDF and CCDF.

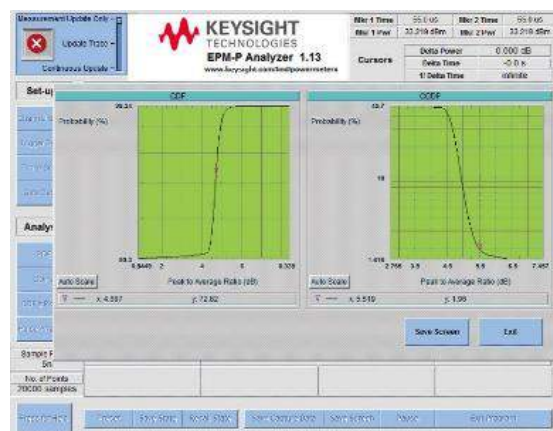

## EPM-P analyzer software

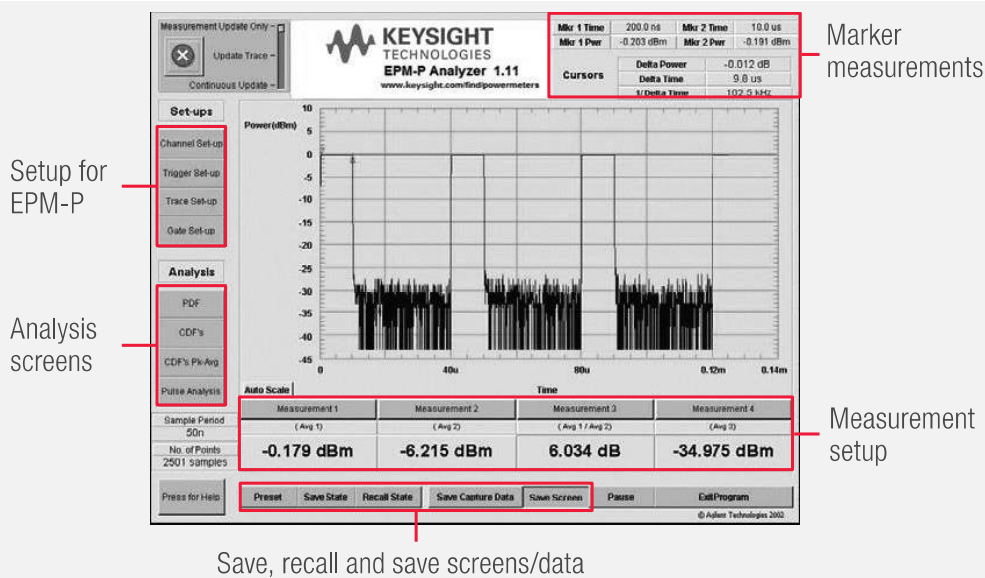

### Setups for EPM-P

This software controls the power meter and is used to set up the Channel, Trigger and Gate Setups as shown through the front panel.

### Analysis screens

After the power meter is configured, the trace is captured to allow for analysis of the captured trace data. There are various analysis screens covering statistical analysis such as Probability Density Function (PDF) and Complementary Cumulative Distribution Function (CCDF or 1-CDF) measurements and pulse analysis.

### Marker measurements

When the trace is captured, the marker measurements can be used to provide time and power information, and the trace can also be zoomed in to look closely at areas of interest.

### Measurement setup

The display can show up to four real-time power measurements, which are configured in a similar manner to the power meter display, and allows time-gated average, peak, peak-to-average ratio measurements, as well as combination measurements to be displayed.

### Save, recall, and save screens/data

If the analyzer display is required for reports or import into other applications, the screen can be saved as a JPG or BMP file and the power and time data from the captured trace can also be saved in a CSV file. The analyzer software allows 10 states to be stored and recalled. This ensures easy setup of the analyzer software and allows repeatable measurements to be obtained. These states are saved in a separate file, and stored on the PC or a disc, ensuring users on different PCs are operating the same setups and therefore making the same measurements.



## Average Power Measurements for Metrology and Calibration Laboratories

### Keysight N432A thermistor power meter

The N432A is a single-channel, average RF power meter that's ideal for high-accuracy measurement applications, particularly metrology and calibration laboratory environments.



### Features

#### Measurement type

- Average power measurements

#### Calibration

- Built-in calibration factor table

#### Remote programmability

- SCPI standard interface commands

#### Highly accurate RF measurements for metrology and calibration

The N432A's high 0.2% accuracy, coupled with Keysight 478A-H75/H76 thermistor sensors, makes it excellent for 1 mW transfer calibration.



#### Highlights

- High accuracy ( $\leq 0.2\% \pm 0.5 \mu\text{W}$ )
- Built-in 6.5-digit ADC eliminates the need for an external DMM
- DC substitution measurement, traceable to the U.S. National Institute of Standards and Technology (NIST)
- Selectable bridge resistance
- Digital color LCD display, and user-friendly interface



## Average Power Measurements for Flexible Testing: On the Rack and On the Go

### Keysight N1913A/14A EPM Series power meters

The Keysight N1913A/14A EPM Series power meters are versatile, user-friendly replacements for the popular E4418B/19B EPM power meters. They deliver fast, repeatable, reliable results for both bench/rack and field applications.



### Features

#### Models

- Single-channel N1913A
- Dual-channel N1914A
- One or two additional channels with USB power sensor(s)

#### Measurement type

- Average power measurements

#### Calibration

- Calibration and correction factors in EEPROM (E-Series and N8480 Series)

#### Remote programmability

- SCPI standard interface commands
- GPIB, USB and LAN/LXI-C interfaces

#### Backward-compatibility

- Code-compatible with legacy E4418B/9B EPM Series, 436A, 437B and 438A power meters (43X compatibility only with Option N191xA-200)



#### Highlights

- Up to four-channel power measurements
- Fast measurement speed of 400 readings/second
- Industry's first color LCD screen in an average power meter
- Convenient field usage with operating case and battery option
- Optional external trigger feature for automatic frequency/power sweep measurements
- VGA output option for connection to external monitor

### View measurements better in any lighting and angle

The new EPM Series come with the industry's first color LCD in an average power meter. With its high-resolution color and wide viewing angle, you can see your test results more easily—no matter where you are.



### Perform field measurements conveniently

You can easily carry an EPM Series power meter in its operating case when you need to travel between stations. This meter is also available with a battery option and one-button battery power level check so you can keep your power meters at its optimum capacity before your next field task. To ensure continuous power, you can opt for a spare battery pack (Option N191xA-300).



# Average Power Measurements for Mobile Testing that's Plug-and-Play Easy

## Keysight U2000 Series USB power sensors

Standalone USB-based U2000 Series power sensors enable power measurements without power meters. Using USB power and providing built-in triggering, these power sensors don't need external power adapters or triggering modules for synchronization with external instruments or events. All these make the U2000 Series an ideal choice for high performance mobile power measurements.

### Features

#### Measurement type

- Average power measurements
- Frequency range: 9 kHz to 24 GHz
- Dynamic range: -60 dBm to 44 dBm

#### Remote programmability

- USB interface

#### Backward-compatibility

- Code-compatible with E4418B EPM Series power meter



#### Highlights

- Travel with lighter-weight instruments
- Set-up easily with USB, and measure from practically anywhere beyond USB cable length
- Save time connecting/disconnecting sensor with internal zeroing
- RF burst signal measurement with time-gating
- Built-in internal triggering and trace graph display

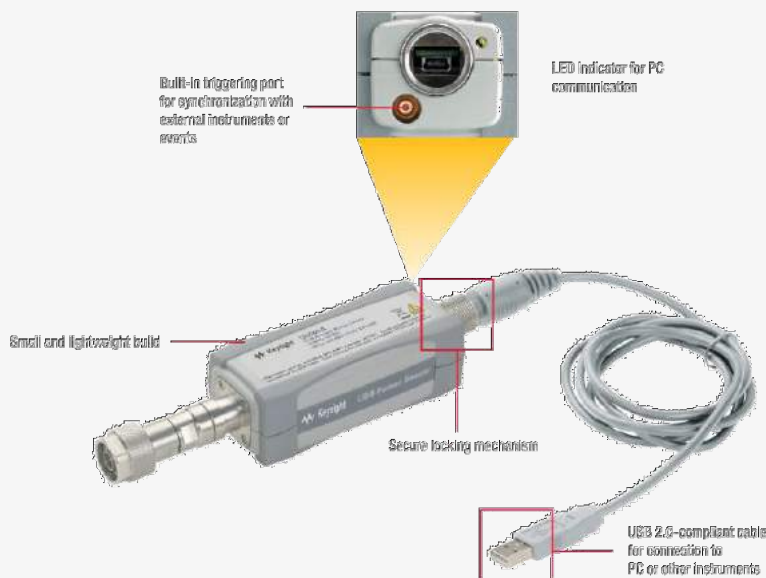

## Perform antenna testing across any distance

When a USB power sensor is connected to a USB-to-LAN hub, you can perform measurements beyond the limits of USB cable length. Conveniently leave your sensor connected to the power tap-off—even while performing zeroing — and monitor your measurements remotely.

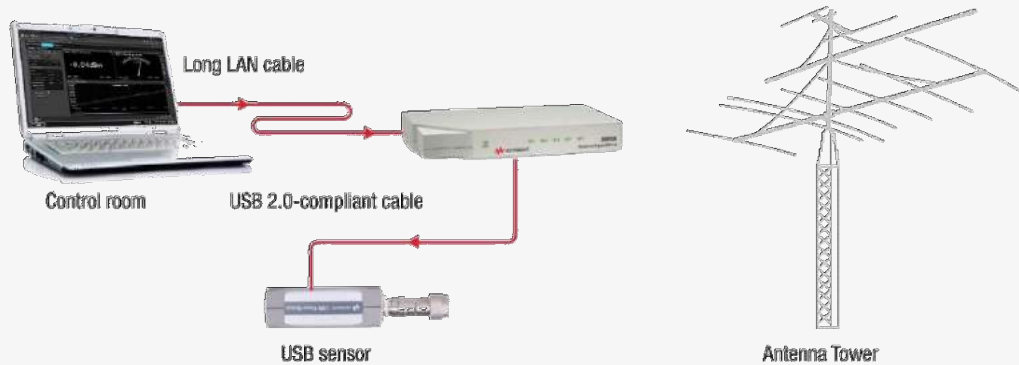

## Perform base station testing without the usual bulkiness

When you need to take power measurements on the road or up a base station tower, smaller, lighter, and fewer is better. With the USB power sensors, the only other thing you'll need is a laptop with BenchVue software installed.

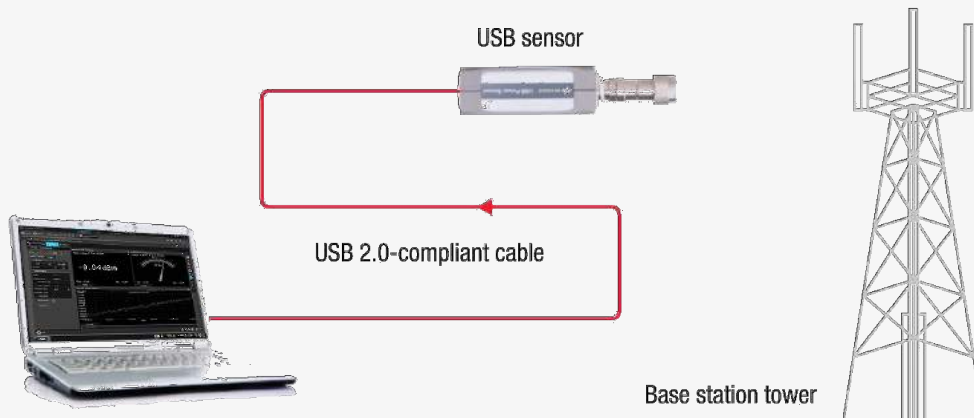

## Reduce sensor connection/disconnection

With a U2000 Series sensor's internal zeroing capability, you don't need to power off the device-under-test or disconnect the sensor. This saves test time and reduces sensor wear-and-tear — advantages that are especially crucial in applications where every second counts, such as manufacturing test. With internal zeroing, the sensor can be left connected to the test fixture.



## Add power measurements to other instruments

The USB power sensors give more accurate measurements than other RF measurement instruments such as signal analyzer, signal generator, vector network analyzer, FieldFox, etc. You can connect a USB power sensor to the instrument, and you can switch between the power measurement with the USB power sensor and the instrument's original functions at any time.



## Average Power Measurements for Broadband Applications

### Keysight U8480 Series USB thermocouple power sensors

The U8480 Series USB power sensors is one of the most cost-effective solutions in Keysight's power meter and sensor portfolio, providing top performance features at costs so affordable that every engineer can carry one in their bags. These sensors come with a measurement speed of 900 readings/second and power linearity of less than 0.8%, providing high accuracy and stability to help you make average power measurements from DC to 120 GHz (sensor dependent) quickly and confidently.



### Features

#### Models

- U8481A USB thermocouple power sensor (DC/10 MHz to 18 GHz; -35 dBm to +20 dBm)
- U8485A USB thermocouple power sensor (DC/10 MHz to 33 GHz; -35 dBm to +20 dBm)
- U8487A USB thermocouple power sensor (10 MHz to 50 GHz; -35 dBm to +20 dBm)
- U8488A USB thermocouple power sensor (10 MHz to 67 GHz; -35 dBm to +20 dBm)
- U8489A USB thermocouple power sensor (DC to 120 GHz; -35 dBm to +20 dBm)

#### Specifications

- 900 readings/s measurement speed
- Power linearity: < 0.55% (-1 to +15 dBm); < 0.80% (+15 to +30 dBm)
- Damage level (RF): 25 dBm (average power); 15 W (2  $\mu$ s duration) (peak power)
- Damage level (DC): AC coupled (option 100), 50 V; DC coupled (option 200), 4 V
- Zero set: < 25 nW
- Zero drift: < 10 nW
- Measurement noise: < 80 nW

#### Measurement type

- Average power measurements

#### Calibration

- Internal calibration



#### Highlights

- Measurement speed of 900 readings/second and power linearity of < 0.8%
- Keysight's first power sensor to measure down to DC (sensor dependent)
- Add power measurement capabilities to selected Keysight instruments, and switch between power measurements and the instrument's original function when needed
- Improve accuracy with real time measurement uncertainty feature
- Correct for errors with the S-parameter and gamma correction functions





## Remote programmability

- USB interface

## Continuous remote monitoring of satellite communication systems

Many satellite communication systems operate at microwave frequencies such as X, Ku and Ka bands, which supports wider modulation bandwidth, increased capacity and enables the use of smaller antennas. The U8480 Series covers a wide frequency range from DC to 120 GHz (sensor dependent) and can test satellites up to Ku or Ka bands. The USB sensors also come with a built-in DC reference source and excellent long term drift performance and can be left connected to a test setup without human intervention for several months, making the U8480 Series an ideal solution for long term, remote monitoring of satellite communication systems.

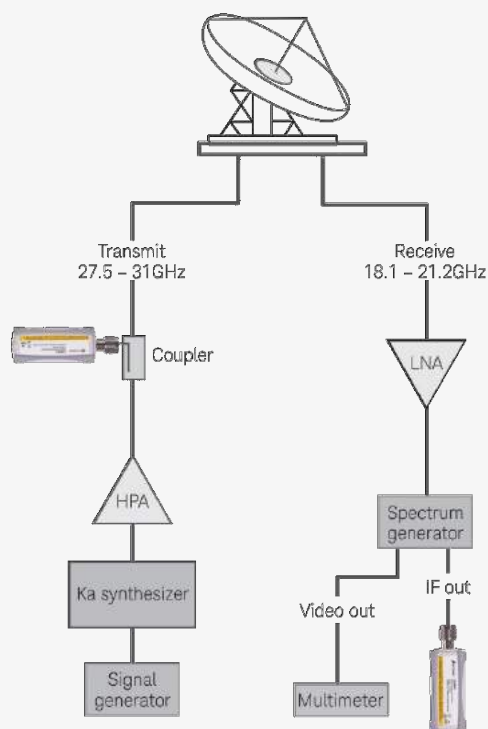

Typical satellite test system set-up

## Perform measurement/calibration down to DC range

The U8481A/85A/89A USB thermocouple sensors have the ability to perform measurements down to the DC range, which is often used for source calibration and power measurement reference for Keysight instruments such as the PNA/PNA-X network analyzers and the MXG X-Series signal generators. DC range measurements are also applicable to some EMC applications.



## Average Power Measurements for mmWave applications

### Keysight 8486A Waveguide Power Sensors

Covering the V-band, E-band and W-band spectrums, the Keysight Technologies, Inc. waveguide power sensors offer best SWR, high reliability and low loss, and come with a 50 MHz calibration port to reduce measurement uncertainties.



### Features

#### Models

- V8486A V-Band waveguide power sensor, 50 to 75 GHz (-30 to +20 dBm, -60 to +20 dBm with option H02)
- E8486A E-Band waveguide power sensor, 60 to 90 GHz (-30 to +20 dBm, -60 to +20 dBm with option 200)
- W486A W-band waveguide power sensor, 75 to 110 GHz (-30 to +20 dBm)

#### Specifications

- SWR < 1.06
- Zero set <  $\pm 200$  nW (<  $\pm 200$  pW with opt 200 or H02)
- Measurement noise < 450 nW (< 450 pW with opt 200 or H02)
- Zero drift <  $\pm 40$  nW (<  $\pm 40$  pW with opt 200 or H02)

#### Measurement type

- Average power measurements

#### R and Q band models

- R8486D Waveguide power sensor, 26.5 GHz to 40 GHz (-70 dBm to -20 dBm)
- Q8486D Waveguide power sensor, 33 GHz to 50 GHz (-70 dBm to -20 dBm)
- N8486AR Thermocouple waveguide power sensor, 26.5 GHz to 40 GHz (-35 dBm to +20 dBm)
- N8486AQ Thermocouple waveguide power sensor, 33 GHz to 50 GHz (-35 dBm to +20 dBm)



#### Highlights

- Best SWR (1.06) minimizes the measurement uncertainty caused by mismatch.
- The 50 MHz calibration port offers an easy calibration and eliminates the variance in making measurements with different meter/sensor combinations and the uncertainties due to temperature.
- Reliable measurements using Modified Barrier Integrated Diode (MBID) technology operates in the square-law characteristic for true-average detection.



# Average Power Measurements for Portable RF Measurements

## Keysight V3500A handheld RF power meter

The V3500A is a portable, palm-sized power meter with an integrated power sensor and built-in display. Compact with essential average power measurement capabilities, the V3500A is a handy tool for installation and maintenance or R&D lab environments.



### Features

#### Measurement type

- Average power measurements
- Frequency range: 10 MHz to 6 GHz
- Dynamic range: -60 dBm to 20 dBm

#### Remote programmability

- Programming languages: Microsoft Visual Studio.NET, Microsoft Visual Basic, and Microsoft Visual C++
- USB interface

### Truly portable for field measurements

The V3500A provides an optional loop holster carrying case with a shoulder strap. The handheld comes with a backlit display and illuminated keypad to help you make measurements in poorly lit conditions.



#### Highlights

- Small and lightweight form that fits in your palm, no separate power sensor or display needed
- Internal power reference enables self-calibration
- Absolute accuracy up to  $\pm 0.21$  dB
- Multiple power-up methods: AA batteries, computer via USB interface, AC-DC converter module (Option PWR)

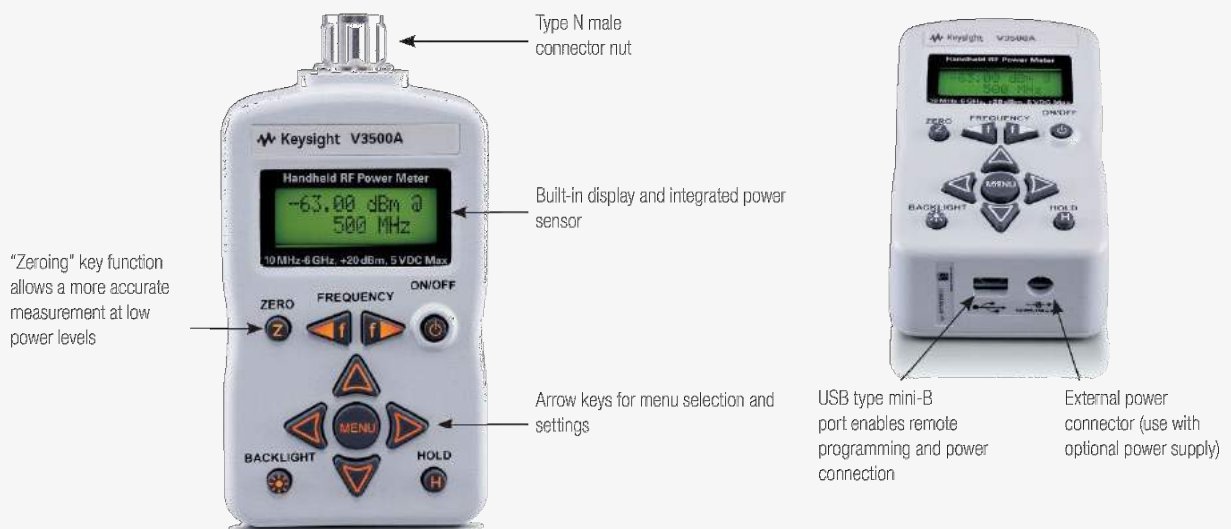

## N1913PM5B VDI Erickson PM5B MM-Wave Power Meter with W-Band Sensor, Optional Tapers to 1.5 THz

### Keysight N1913BPM5B MM-Wave Power Meter

Keysight N1913PM5B is a Virginia Diodes, Inc./Erickson PM5B calorimetric mm-wave power meter, with a W-Band sensor for power measurement over a frequency range of 75-110 GHz.



### Features

- 75 GHz to 110GHz, and up to 1.5 THz with optional taper accessories
- Controlled by VNA firmware via USB
- Includes built-in calibration verification feature
- Source power calibration of banded mmWave VNAs
- Measures the output power of banded mmWave signal sources
- Additional waveguide tapers are available to enable measurement of power up to 1.5 THz.
- Can be used for the source power calibration of mmWave banded network analyzer configurations, and be used to measure the power of banded mm-wave signal sources with E8257DVxx VDI or E8257DSxx OML frequency extension modules

## Power Measurement Software for Simplified Data Capture

### BenchVue software

The Keysight BenchVue software for the PC accelerates testing by providing intuitive, multi instrument measurement visibility and data capture with no programming necessary. You can derive answers faster than ever by easily viewing, capturing, and exporting measurement data and screenshots.



The Power Meter/Sensor Control and Analysis App (BV0007B) for BenchVue enables control of power meters and power sensors to data log and visualize measurements in a wide array of display formats. It can control multiple meters/sensors from a single instance. Calibrations can be done fast with software buttons. Presets allow quick analysis of power levels of industry standard communications signals. Trial licenses can be started with one-click using the button to the left. Licenses may be purchased from Keysight or directly from your preferred Keysight Distributor.



This app supports Keysight's USB/LAN power sensors and some power meters. Measurement Display options include:

- Digital Meter Views- to display precise and exact reading (up to 4 decimal points) measured by the instrument
- Analog Meter Views- to display measured reading in analog form for easier visualization of large measurement differences
- Strip Chart- to display measured reading in a graphical form (Power/time)
- CCDF View- to display the Complementary Cumulative distribution function
- Trace View- to display traces of modulated signal
- Multilist View- to display multiple power measurements

### Key features and specifications

- Control and setup your Power meters and sensors
- Setup all necessary parameters for your critical measurements
- Control multiple power meters/sensors from one instance of the software
- Log and view measurement data in the format you need:
  - With 6 different display types seeing what you care about has never been easier or more flexible
  - Export results in three clicks: Export data quickly to popular tools such as Matlab and Microsoft Excel or Word for documentation or further analysis.

### Supported models

- U2021XA, U2022XA
- U2041XA, U2042XA, U2043XA, U2044XA, U2049XA
- U2051XA, U2052XA, U2053XA, U2054XA, U2055XA, U2061XA, U2062XA, U2063XA, U2064XA, U2065XA, L2051XA, L2052XA, L2053XA, L2054XA, L2055XA, L2061XA, L2062XA, L2063XA, L2064XA, L2065XA, L2065XT
- U2000A, U2000B, U2000H, U2001A, U2001B, U2001H, U2002A, U2002H, U2004A
- U8481A, U8485A, U8487A, U8488A, U8489A
- N1911A, N1912A, N1913A, N1914A
- N8262A



#### Highlights

- Visualize multiple measurements simultaneously
- Easily log data, screen images and system state
- Recall past state of your bench to replicate results
- Fast measurement data export in desired formats
- Quickly access manuals, drivers, FAQs and videos
- Monitor and control your bench from mobile devices





Digital meter, analog meter and datalog view





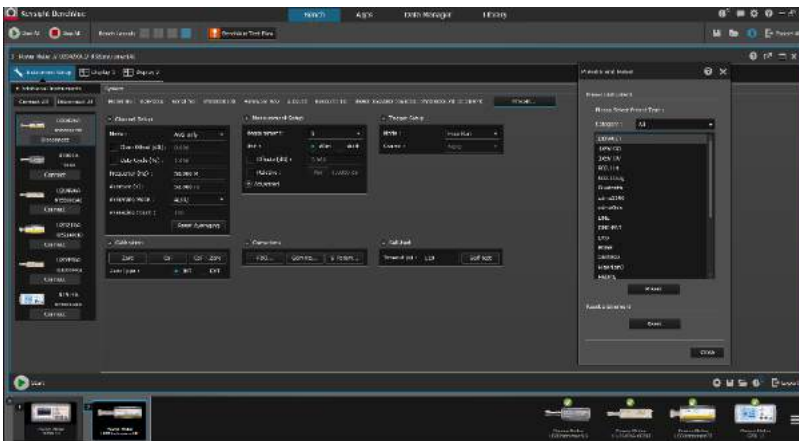

Multi-channel trace display with 4-pairs of gates and automatic pulse parameters measurement









Multi-list view with ratio/difference function



## Power Meters Selection Chart

Peak power measurement		
<b>EPM-P E4416A/17A</b> (VBW: 5 MHz)		<b>Power sensor options</b>
	<ul style="list-style-type: none"> <li>• E932x Peak-and-Average Sensors (300 kHz, 1.5 MHz, 5 MHz)</li> <li>• * Also compatible with all average power sensors</li> </ul>	
<b>P-Series N1911A/12A</b> (VBW: 30 MHz)	<b>P-Series modular N8262A</b> (VBW: 30 MHz)	<b>Power sensor options for the P-Series meters</b>
		<ul style="list-style-type: none"> <li>• N1921A/22A Wideband Sensors (30 MHz)</li> <li>• E932x Peak-and-Average Sensors (300 kHz, 1.5 MHz, 5 MHz)</li> <li>• * Also compatible with all average power sensors</li> </ul>
<b>U2020 X-Series USB power sensors</b> (VBW: 30 MHz)	<b>U2042/44/49 &amp; U/L2060 X-Series USB/LAN power sensors</b> (VBW: 5 MHz)	
		



Average power measurement		
EPM N1913A/14A	N432A thermistor power meter	U8480 Series USB thermocouple power sensors
		
Power sensor options <ul style="list-style-type: none"> <li>• 848xD Diode Sensors</li> <li>• N848x Thermocouple Sensors</li> <li>• 8486 Waveguide Sensors</li> <li>• E441x 1-Path Diode CW-only Sensors</li> <li>• E930x 2-Path Diode True-Average Sensors</li> <li>• Compatible with U2000 Series and U2040 X-Series and U2050 X-Series USB power sensors</li> </ul>	Power sensor options <ul style="list-style-type: none"> <li>• 478A and 8478B Thermistor Sensor</li> </ul>	
U2000 Series USB power sensors	U2041/43 & U/L2050 X-Series USB/LAN power sensors	V3500A handheld RF power meter
		





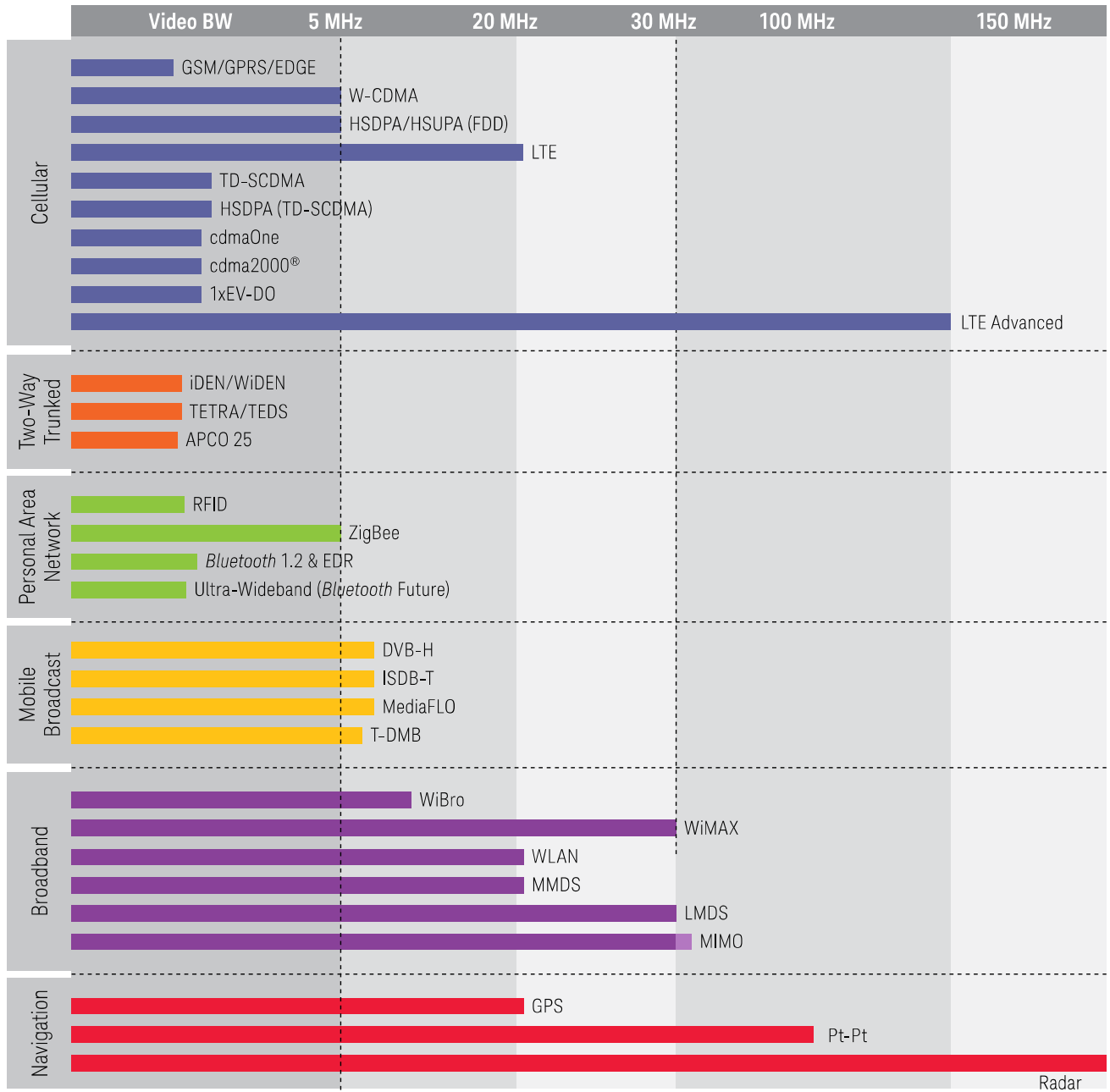

# Power Sensors Selection Chart

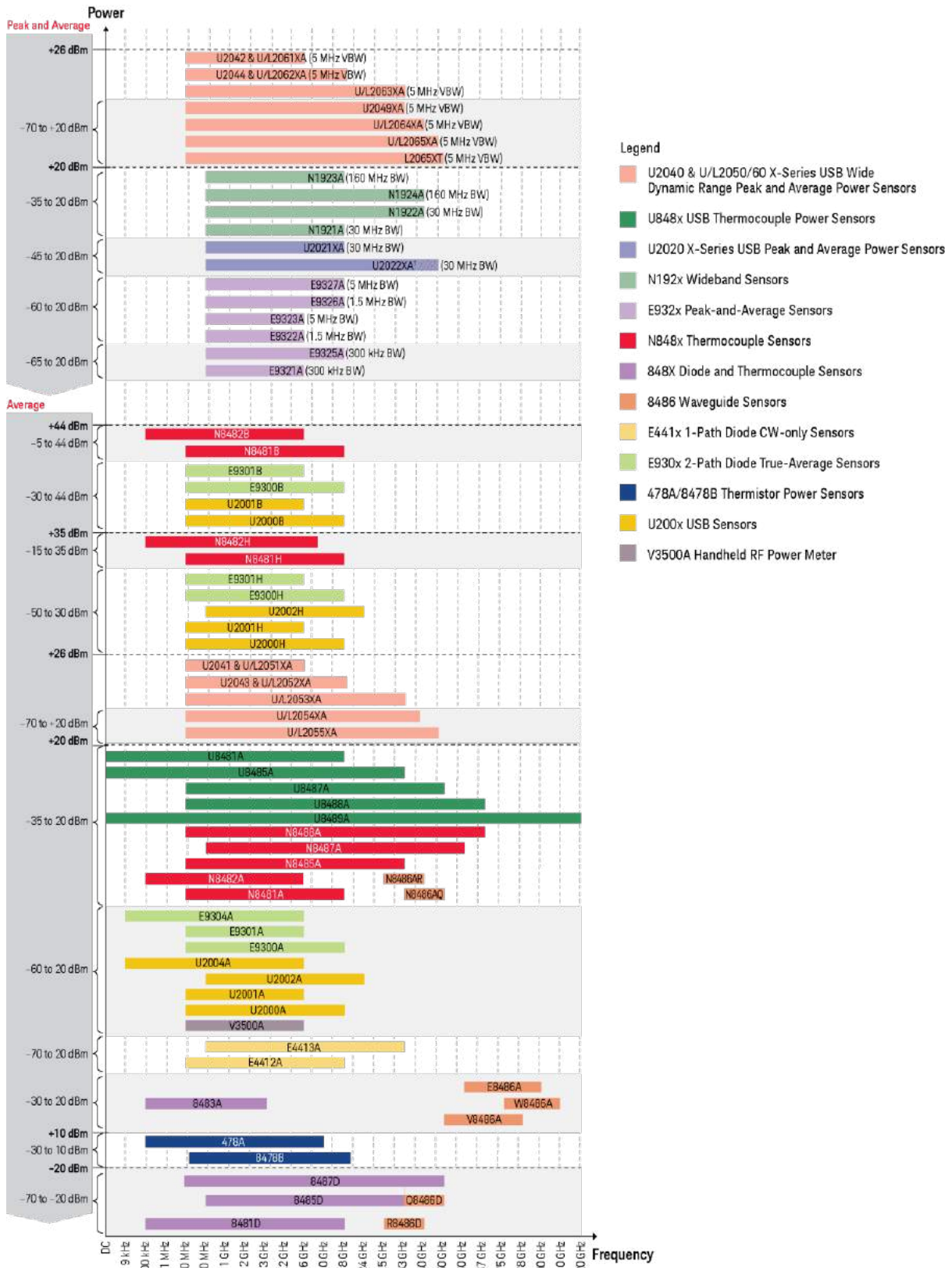

## Power Meters and Sensors Compatibility Table

		POWER METERS								
		N432A	N1913A/ 14A EMP	N1911A/ 12A & N8262A P-Series	E4416A/ 17A EPM-P	Product description/ Sensor tech.	Frequency range	Power range		
POWER SENSORS	U2040 and U/L2050/60 X-Series USB/LAN wide dynamic range sensors	U2041XA	-	✓	-	-	USB Diode Power Sensor	10 MHz to 6 GHz	-70 dBm (100 pW) to +26 dBm (398 mW)	
		U2042XA	-	✓	-	-		10 MHz to 6 GHz	-70 dBm (100 pW) to +26 dBm (398 mW)	
		U2043XA	-	✓	-	-		10 MHz to 18 GHz	-70 dBm (100 pW) to +26 dBm (398 mW)	
		U2044XA	-	✓	-	-		10 MHz to 18 GHz	-70 dBm (100 pW) to +26 dBm (398 mW)	
		U2049XA	-	-	-	-	LAN/TVAC Diode Power Sensor	10 MHz to 33 GHz	-70 dBm (100 pW) to +20 dBm (100 mW)	
		U2051XA	-	-	-	-	USB Diode Power Sensor	10 MHz to 6 GHz	-70 dBm (100 pW) to +26 dBm (398 mW)	
		U2052XA	-	-	-	-		10 MHz to 18 GHz	-70 dBm (100 pW) to +26 dBm (398 mW)	
		U2053XA	-	-	-	-		10 MHz to 33 GHz	-70 dBm (100 pW) to +26 dBm (398 mW)	
		U2054XA	-	-	-	-		10 MHz to 40 GHz	-70 dBm (100 pW) to +20 dBm (100 mW)	
		U2055XA	-	-	-	-		10 MHz to 50/53 GHz	-70 dBm (100 pW) to +20 dBm (100 mW)	
		U2061XA	-	-	-	-		10 MHz to 6 GHz	-70 dBm (100 pW) to +26 dBm (398 mW)	
		U2062XA	-	-	-	-		10 MHz to 18 GHz	-70 dBm (100 pW) to +26 dBm (398 mW)	
		U2063XA	-	-	-	-		10 MHz to 33 GHz	-70 dBm (100 pW) to +26 dBm (398 mW)	
		U2064XA	-	-	-	-		10 MHz to 40 GHz	-70 dBm (100 pW) to +20 dBm (100 mW)	
		U2065XA	-	-	-	-		10 MHz to 50/53 GHz	-70 dBm (100 pW) to +20 dBm (100 mW)	
		L2051XA	-	-	-	-		LAN Diode Power Sensor	10 MHz to 6 GHz	-70 dBm (100 pW) to +26 dBm (398 mW)
		L2052XA	-	-	-	-			10 MHz to 18 GHz	-70 dBm (100 pW) to +26 dBm (398 mW)
		L2053XA	-	-	-	-	10 MHz to 33 GHz		-70 dBm (100 pW) to +26 dBm (398 mW)	
		L2054XA	-	-	-	-	10 MHz to 40 GHz		-70 dBm (100 pW) to +20 dBm (100 mW)	
		L2055XA	-	-	-	-	10 MHz to 50/53 GHz		-70 dBm (100 pW) to +20 dBm (100 mW)	
		L2061XA	-	-	-	-	10 MHz to 6 GHz		-70 dBm (100 pW) to +26 dBm (398 mW)	
		L2062XA	-	-	-	-	10 MHz to 18 GHz		-70 dBm (100 pW) to +26 dBm (398 mW)	
		L2063XA	-	-	-	-	10 MHz to 33 GHz		-70 dBm (100 pW) to +26 dBm (398 mW)	
		L2064XA	-	-	-	-	10 MHz to 40 GHz		-70 dBm (100 pW) to +20 dBm (100 mW)	
		L2065XA	-	-	-	-	10 MHz to 50/53 GHz		-70 dBm (100 pW) to +20 dBm (100 mW)	
		L2065XT	-	-	-	-	LAN TVAC Diode Power Sensor		10 MHz to 53 GHz	-70 dBm (100 pW) to +20 dBm (100 mW)



POWER METERS								
		N432A	N1913A/ 14A EMP	N1911A/ 12A & N8262A P-Series	E4416A/ 17A EPM-P	Product description/ Sensor tech.	Frequency range	Power range
<b>U8480 Series USB thermocouple sensors</b>	U8481A	–	✓	–	–	USB Thermocouple Power Sensor	DC/10 MHz to 18 GHz	–35 dBm (316 nW) to +20 dBm (100 mW)
	U8485A	–	✓	–	–		DC/10 MHz to 33 GHz	
	U8487A	–	✓	–	–		10 MHz to 50 GHz	
	U8488A	–	✓	–	–		10 MHz to 67 GHz	
	U8489A	–	✓	–	–		DC to 120 GHz	
<b>U2020 X- Series USB sensors</b>	U2021XA	–	–	–	–	USB Diode Power Sensor	50 MHz to 18 GHz	–35 dBm (316 nW) to +20 dBm (100 mW)
	U2022XA	–	–	–	–		50 MHz to 40/50 GHz	
<b>P-Series Wideband sensors</b>	N1921A	–	–	✓	–	Diode Power Sensor	50 MHz to 18 GHz	–35 dBm (316 nW) to +20 dBm (100 mW)
	N1922A	–	–	✓	–		50 MHz to 40 GHz	
<b>E-Series Peak-and- Average sensors</b>	E9321A	–	–	✓	✓	Diode Power Sensor	50 MHz to 6 GHz	–65 dBm (320 pW) to +20 dBm (100 mW)
	E9322A	–	–	✓	✓		50 MHz to 6 GHz	
	E9323A	–	–	✓	✓		50 MHz to 6 GHz	
	E9325A	–	–	✓	✓		50 MHz to 18 GHz	
	E9326A	–	–	✓	✓		50 MHz to 18 GHz	
	E9327A	–	–	✓	✓		50 MHz to 18 GHz	
<b>E-Series True Average sensors</b>	E9300A	–	✓	✓	✓	Diode Power Sensor	10 MHz to 18 GHz	–60 dBm (1 nW) to +20 dBm (100 mW)
	E9301A	–	✓	✓	✓		10 MHz to 6 GHz	
	E9304A	–	✓	✓	✓		9 kHz to 6 GHz	
	E9300B	–	✓	✓	✓		10 MHz to 18 GHz	
	E9301B	–	✓	✓	✓		10 MHz to 6 GHz	
	E9300H	–	✓	✓	✓		10 MHz to 18 GHz	
	E9301H	–	✓	✓	✓		10 MHz to 6 GHz	
<b>E-Series CW- only sensors</b>	E4412A	–	✓	✓	✓	Diode Power Sensor	10 MHz to 18 GHz	–70 dBm (100 pW) to +20 dBm (100 mW)
	E4413A	–	✓	✓	✓		50 MHz to 26.5 GHz	
<b>N8480/8480 Series Thermocouple and Diode sensors</b>	N8481A	–	✓	✓	✓	Thermocouple Power Sensor	10 MHz to 18 GHz	–35 dBm (316 nW) to +20 dBm (100 mW)
	N8482A	–	✓	✓	✓		100 kHz to 6 GHz	
	8483A 75 ohms	–	✓	✓	✓		100 kHz to 2 GHz	
	N8485A	–	✓	✓	✓		10 MHz to 26.5 GHz	
	N8487A	–	✓	✓	✓		50 MHz to 50 GHz	
	N8488A	–	✓	✓	✓	10 MHz to 67 GHz		
	N8481B	–	✓	✓	✓	High Power Thermocouple Sensor	10 MHz to 18 GHz	–5 dBm (316 μW) to +44 dBm (25 W)
	N8482B	–	✓	✓	✓		100 kHz to 6 GHz	
	N8481H	–	✓	✓	✓		10 MHz to 18 GHz	
							–15 dBm (32 μW) to +35 dBm (3 W)	

POWER SENSORS



POWER METERS									
POWER SENSORS		N432A	N1913A/ 14A EMP	N1911A/ 12A & N8262A P-Series	E4416A/ 17A EPM-P	Product description/ Sensor tech.	Frequency range	Power range	
	N8480/8480 Series Thermocouple and Diode sensors	N8482H	–	✓	✓	✓	High Power Thermocouple Sensor	100 kHz to 6 GHz	–15 dBm (32 µW) to +35 dBm (3 W)
		8481D	–	✓	✓	✓	Diode Power Sensor	10 MHz to 18 GHz	–70 dBm (100 pW) to –20 dBm (10 µW)
		8485D	–	✓	✓	✓		50 MHz to 26.5 GHz	
		8487D	–	✓	✓	✓		50 MHz to 50 GHz	
	Waveguide sensors	R8486D	–	✓	✓	✓	Waveguide Power Sensor	26.5 GHz to 40 GHz	–70 dBm (100 pW) to –20 dBm (10 µW)
		Q8486D	–	✓	✓	✓		33 GHz to 50 GHz	
		N8486AR	–	✓	✓	✓	Thermocouple Waveguide Power Sensor	26.5 GHz to 40 GHz	–35 dBm (316 µW) to +20 dBm (100 mW)
		N8486AQ	–	✓	✓	✓		33 GHz to 50 GHz	
		V8486A	–	✓	✓	✓	V-band Power Sensor	50 GHz to 75 GHz	–30 dBm (1 µW) to +20 dBm (100 mW)
W8486A		–	✓	✓	✓	W-band Power Sensor	75 GHz to 110 GHz		
E8486A		–	✓	✓	✓	E-band Power Sensor	60 GHz to 90 GHz	–60 dBm (1 nW) to +20 dBm (100 mW)	
E8486A- 200		–	✓	✓	✓		60 GHz to 90 GHz		
Thermistor mount sensors	478A	✓	–	–	–	Coaxial Thermistor Mount	10 MHz to 10 GHz	–30 dBm (1 µW) to +10 dBm (10 mW)	
	8478B	✓	–	–	–		10 MHz to 10 GHz		
USB average sensors	U2000A	–	✓	–	–	USB Diode Power Sensor	10 MHz to 18 GHz	–60 dBm (1 nW) to +20 dBm (100 mW)	
	U2001A	–	✓	–	–		10 MHz to 6 GHz		
	U2002A	–	✓	–	–		50 MHz to 24 GHz		
	U2004A	–	✓	–	–		9 kHz to 6 GHz		
	U2000B	–	✓	–	–		10 MHz to 18 GHz	–30 dBm (1 µW) to +44 dBm (25 W)	
	U2001B	–	✓	–	–		10 MHz to 6 GHz		
	U2000H	–	✓	–	–		10 MHz to 18 GHz	–50 dBm (10 nW) to +30 dBm (1 W)	
	U2001H	–	✓	–	–		10 MHz to 6 GHz		
	U2002H	–	✓	–	–		50 MHz to 24 GHz		

## Free Power Measurement Hints and Tips

Keysight offers a wide selection of power meters and sensors for your application needs, and to help you make better measurements in less time, we've compiled an array of resources for you.



## Related Keysight Literature

Here are some key topics that may interest you:

Publication title	Publication number
Reliable Satellite Testing and Remote Monitoring	5991-3681EN
Achieving Accurate E-band Power Measurements with E8486A Waveguide Power Sensors	5991-3776EN
An RF Power Measurement Solution for Multi-Antenna MIMO Transmissions	5991-3097EN
Understanding DC-coupled and DC-blocked Power Sensors	5990-6745EN
MIMO Measurement Tips with Power Meter & USB Power Sensor	5990-3546EN
P-Series and EPM-P Power Meters for Bluetooth Testing	5989-8459EN
4 Steps for Making Better Power Measurements	5965-8167E
How to Choose the Right Power Meter and Power Sensor	5968-7150E