Instruction Manual

Current Probe SS-560/570

IWATSU

Distributed by:

Sie haben Fragen oder wünschen eine Beratung? Angebotsanfrage unter +49 7121 / 51 50 50 oder über info@datatec.eu

dataTec

Contents

Preface	1
Safety Precautions	1
Checking packed materials	9
Components	10
Management of instrument	10
Repair and sending instrument to be repaired	10
Cleaning of instrument	10
1 Overview	11
1.1 Current Probe	11
1.2 Features	11
1.3 Names of Parts	12
1.4 Part Functions	12
2 Specifications	15
2.1 Instrument Specifications (SS-560)	15
2.2 Certification Standards (SS-560)	16
2.3 Instrument Specifications (SS-570)	18
2.4 Certification Standards (SS-570)	19
3 Measurement Procedure	21
3.1 Notes on Use	21
3.2 Preparations for Measurement	22
3.3 Demagnetizing and Zero Adjustment	23
3.4 Measurement Procedure	24
Appendix	30
Appendix 1 Recommended power supply and oscilloscope	30





Memo

Preface





- ◇ Thank you for purchasing the Current Probe SS-560/570. We hope that you will enjoy it for years to come.
- ◇ Please read this manual carefully before attempting to use the instrument. Store the manual in a safe place so it can be referred to when necessary.

Safety Precautions

This manual contains information and warnings essential for safe operation of the instrument and for maintaining it in safe operating condition. Before using the instrument, be sure to carefully read the following safety notes.

	<ul style="list-style-type: none">• The  symbol printed on the instrument indicates that the user should refer to a corresponding topic in the manual (marked with the  symbol) before using the relevant.• In the manual, the  symbol indicates particularly important information that the user should read before using the instrument.
	<ul style="list-style-type: none">• Indicates that the instrument cannot be set and detached in the active circuit.

The following symbols in this manual indicate the relative importance of CAUTION and WARNING.

	Indicates that incorrect operation presents an extreme hazard that could result in serious injury or death to the user.
	Indicates that incorrect operation presents a significant hazard that could result in serious injury or death to the user.
	Indicates that incorrect operation presents a possibility of injury to the user or damage to the instrument.
	Indicates advisory items related to performance or correct operation of the instrument.

Note

- ◇ The contents of this manual are subject to change without any prior notice for improvement or other purposes.
- ◇ Unauthorized reproduction of the contents of this manual is strictly prohibited.
- ◇ If you have any questions about this instrument, contact IWATSU or our sales distributors.

Revision history

- ◇ April 2021: 1st edition

Read this page to ensure proper safety. (to be continued)



WARNING

- **Do not use this instrument in an environment with explosive gases.**

This may result in explosion.

- **If you notice smoke, foul odor or abnormal noise, immediately turn off the power supply of all equipment with which this instrument is connected, and then detach this instrument from the insulated target conductor to be measured.**

Continued use under these circumstances may result in electric shock or fire. Contact IWATSU or our sales distributors for repair. Do not attempt to repair this instrument yourself.

- **Turn off the power to the insulated target conductor to be measured before attaching or detaching sensor head part of this instrument to or from the insulated target conductor to be measured.**

Failure to do so is very dangerous for targets to be measured that use high current.

- **Do not use this instrument to measure exposed conducting lines.**

This may result in electric shock, short-circuiting or equipment damage. (The clamp core and shield casing are not insulated.)

- **Use caution not to wet this instrument or allow entry of water or foreign objects into.**

Continued use under these circumstances may result in an electric shock, fire, or failure. If water, foreign objects, or other substances enter this instrument or the instrument is wet with water, immediately turn off the power supply of all equipment with which this instrument is connected, and then detach this instrument from the insulated target conductor to be measured. After that, contact IWATSU or our sales distributors for repair.

- **Do not handle this instrument if your hands are wet.**

This may result in electric shock, fire or equipment damage.

- **Do not touch the plug of the power cord if your hands are wet.**

This may result in electric shock.

Read this page to ensure proper safety. (to be continued)



WARNING

- **Be careful not to damage the insulated sheath of the insulated target conductor to be measured.**
- **Make sure the oscilloscope connected to the BNC output connector on the current probe is used with the protective earth.**

See "Recommended Power Supply and Oscilloscope" of the appendix in the end of this manual for the instrument of our company that corresponds to this.

- **Connect only the recommended power unit to this instrument.**

Use of power units not suited may result in fire or equipment damage. See "Recommended Power Supply and Oscilloscope" of the appendix in the end of this manual for the recommended power supply of our company.

- **When handling power cables and sensor cables:**

This may result in fire, electric shock or equipment damage. If the power cord is damaged, contact IWATSU or our sales distributors for repair.

- Do not attempt to fabricate power cord and sensor cable.
- Do not pull power cord and sensor cable by the cable. Always grasp the plug.
- Do not bend power cord and sensor cable.
- Do not heat power cord and sensor cable.
- Do not twist power cord and sensor cable.
- Avoid getting power cord and sensor cable wet.
- Do not bind power cord and sensor cable together.
- Do not place heavy objects on top of power cord and sensor cable.

- **Do not place this instrument in an area there frequent vibrations or impacts occur.**

If this instrument is dropped or overtuned, it may cause a physical injury or a malfunction.

Read this page to ensure proper safety. (to be continued)



WARNING

- **Do not use this instrument in a highly humid environment where condensation may occur.**

If using, an electric shock, fire, or failure may occur.

- **When thunder begins, pull out the power plug of a device or the AC adaptor to which this instrument is connected from the outlet. Then, detach this instrument from the target to be measured, and do not use it.**

Lightning may be a cause of an electric shock, fire, or failure.

- **Do not put on this instrument a container that water, medicine, etc. has entered or a small metallic object.**

If not, an electric shock or fire may occur. If this instrument is wet with water, or metal and other objects enter the instrument, immediately turn off the power supply of all equipment with which this instrument is connected, and then detach this instrument from the insulated target conductor to be measured. After that, contact IWATSU or our sales distributors for repair.

- **Do not put any metallic or flammable foreign object through the ventilation port.**

If any metallic or flammable foreign object is put through the ventilation port, this may cause a fire, an electric shock, or a malfunction.

- **Do not use this instrument when it has failed.**

Using a failed main unit or, cable or AC adaptor may be a cause of an electric shock or fire. In the event of a failure, contact Iwatsu office or our sales distributors for repair.

- **Do not attempt to modify or disassemble the unit.**

This may result in electric shock, fire or equipment damage.

Requests to repair the unit may be refused if unauthorized modifications have been made.

- **Do not use this instrument when the case of it has been damaged.**

This may result in electric shock. When the case is damaged, contact IWATSU or our sales distributors for repair.

Read this page to ensure proper safety. (to be continued)



WARNING

- **Do not place any object close to the ventilation port of this instrument.**

If any object close to the ventilation port of this instrument, the air ventilation is blocked and the internal temperature increases, causing a fire or malfunction.

- **The BNC ground of this instrument is connected to an electric ground through the power supply such as PS-52 or PS-54 to prevent danger. Use the equipment only for the floating measurement when executing the floating measurement.**

When the ground terminal of the instrument is connected to a ground besides the earth potential, this instrument, the equipment and the circuit to be measured must be damaged because the equipment that connects this instrument is connected to a ground. Moreover, there must be danger of getting an electric shock.

Wrong example

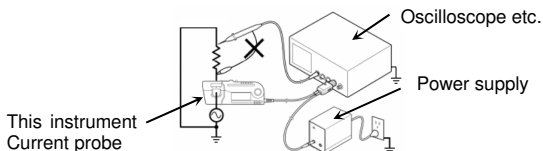

- **Insert the power plug in the outlet after confirming dust etc. do not adhere. The power supply plug are pulled out from the outlet, and moreover, please check and clean it once a year from half a year.**

The dirt causes electric shock, a fire or damage.

- **This instrument SS-560 and SS-570 might not be able to be used at the same time because there are restrictions on power consumption in the probe power on the oscilloscope side according to the measured current.**

Refer to page25 and page30 for details.

Read this page to ensure proper safety. (to be continued)



CAUTION

- **Do not supply current that exceeds the maximum continuous input range.**

The values are derived from the rise in temperature caused when the unit heats up during measurement. Do not input the current that exceeds this. This instrument might be damaged. Moreover, the maximum input range differs depending on the frequency of the current being measured. See Section 2.1 or 2.3 "Instrument Specifications".

- **When current exceeding the maximum continuous input range is supplied, the sensor unit will heat up, triggering an internal protective interlock that will prevent normal output.**

If this happens, cut off the input immediately (either by removing the sensor from the insulated target conductor to be measured or by setting the input current to zero). Then wait for a sufficient amount of time for the unit to cool before resuming normal operation.

- **At high temperatures, the overcurrent protection circuit in the unit may cause the protective interlock to operate at current levels that are below the maximum continuous input range.**

- **Do not subject the unit to sudden rapid changes in temperature, mechanical stress or shocks.**

This may damage the instrument and the sensor head and result in equipment failure.

- **Keep the sensor head closed unless you are clamping the insulated target conductor to be measured in preparation for measurement.**

Leaving the sensor head open may damage the sensor head.

- **When handling the sensor head, be sure to observe the following precautions:**

- The contact end of the sensor head is precision-polished. Handle the unit carefully to avoid damaging this surface. Scratches on the surface may adversely affect performance.
- The end of the sensor head must be kept clean, as dirt on the surface will adversely affect performance. If the surface becomes dirty, wipe it clean with a soft cloth or the like.

Read this page to ensure proper safety. (to be continued)

 **CAUTION**

- **When removing the connector from the power supply receptacle, first unlock the connector, grasp the connector and pull to remove.**

Failure to remove the connector in this manner may damage the terminator.

- **Do not store or use this instrument in direct sunlight or in environments that are subject to high temperatures, high humidity or condensation.**

Use or storage at other than the rated conditions may result in warping due to heat, impaired insulation, or unit failure.

The proper temperature and humidity levels for use and storage are listed below. Note that these environments should also be free from condensation.

- Operating temperature: 0 to +40°C, no dew condensation
- Operating humidity: below the moisture amount of 80%RH
- Storage temperature: -10 to +50°C, no dew condensation
- Storage humidity: below the moisture amount of 80%RH

- **Do not leave this instrument in wet or dusty environments.**

This may result in electric shock, fire or equipment damage.

- **For your safety, when this instrument is not used for a long time, remove the power plug of this instrument from the power supply receptacle.**

- **Do not leave this instrument in a place exposed to lamp soot or steam generated by counters, humidifiers, etc.**

If not, an electric shock, fire, or failure may occur.

- **Hold the power plug part when removing the power supply cord from the power supply receptacle.**

Pulling on the power cord will damage the cord. This may be a cause of an electric shock, fire, or failure.

- **For your safety, remove the power plug of this instrument from the power supply receptacle, make sure that the sensor head, output terminal (BNC) cable and other external connection lines are removed before maintenance. In addition, wipe off with a dry cloth when water droplets are attached.**

If not, an electric shock or failure may occur.

Read this page to ensure proper safety.



CAUTION

- **Securely insert power plug into the power supply receptacle.**
- **Before moving this instrument, make sure that the power supply plug is disconnected from the power supply receptacle and that the sensor head, output terminal (BNC) cable and other external connection lines are removed.**

Failure to do so will damage the sensor head or cable, causing an electrical shock, fire, or failure.

- **Before transporting this instrument, house this instrument in the accessory hard case, and then pack the housed instrument in the packing material used at the time of purchase, or the packing material or better.**

This instrument may fail if a large vibration or impact is applied during transportation, possibly causing a fire. If you do not have a proper packing or shock-absorbing material for transportation, contact IWATSU or our sales distributors. If transportation is to be handled by a forwarding agent, display "Contains a precision machine" on each side of the packing box.

- **We recommend to order IWATSU or our sales distributors for periodical inspection and calibration once a year or so.**

Note

An accurate measurement cannot be likely to be done in the vicinity the generation of a strong magnetic field and strong electric fields such as the transformer, the large current circuits, and the wireless machines.

Checking packed materials

When receiving this instrument, check the packed materials while referring to the next page "Components". If there is a missing item or an item damaged during transportation, immediately contact IWATSU or our sales distributors.

Components

- Current Probe SS-560/5701
- Accessories (See the accessories table below.)

Accessories table

Items	Quantities
Hard case	1
Sheet for China RoHS	1
Instruction Manual (this document)	1
Cable tie	1

Management of instrument

When disposing of this instrument, it must be recycled or disposed of properly in accordance with local laws or regulations. When disposing of it, request a recycling company to dispose of it in accordance with local laws or regulations.

Repair and sending instrument to be repaired

If a failure occurs, send the instrument to IWATSU or our sales distributors.

When sending an instrument to be repaired, clearly write the instrument name, serial number (in the label on the rear of this instrument), description of the failure, and the name, division, and telephone number of the responsible person.

Cleaning of this instrument

When you take the dirt of this instrument, wipe with a soft and dry cloth or wipe with a dry cloth after you wipe with a soft cloth etc. to contain water, and the soapless soap.

Never use neither medicines of thinner, benzine, acetone, ether, ketone, alcohol, and the gasoline system, etc. nor the detergents that contain them.

This instrument is likely to transform, and to discolor.

1 Overview

1.1 Current Probe

This instrument can be directly connected to a BNC input connector of a waveform measuring instrument such as an oscilloscope or recorder, and by clamping on an insulated target conductor to be measured, allows the current waveform to be easily captured.

1.2 Features

- Highly accurate current detection
- Easy current measurement
- Broadband frequency bandwidth
 - SS-560 : DC to 10 MHz
 - SS-570 : DC to 2 MHz
- Large diameter allows high-current measurements.
- Simple protection function to avoid self-heating during excessive input
- Unique development by using thin film Hall element

1.3 Names of Parts

• External view

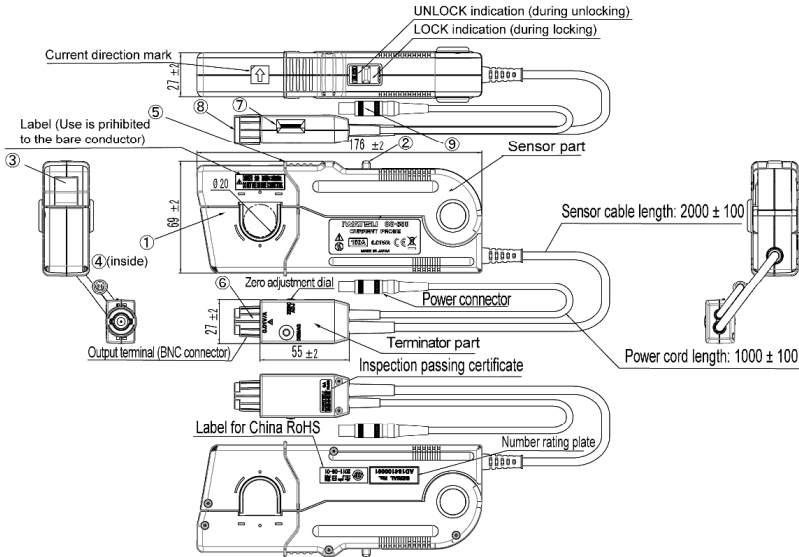

1.4 Part Functions

1. Clamp
This clamps around the insulated target conductor to be measured.
2. Slider
This slider opens the clamp. Always use it to open and close the clamp.
3. Lever
This lock mechanism keeps the clamp closed.
4. Sensor head
This clamps the insulated target conductor to be measured, and carries out the actual current measurement. It is a precision assembly including a molded component, a ferrite core, and a Hall element. It may be damaged if subjected to sudden changes in ambient temperature, or mechanical strain or shock, and therefore great care should be exercised in handling it.
5. Barrier
This structure reduces the likelihood of touching the conductor while testing, and indicates the limit of safe physical contact. Avoid touching the clamp in front of the barrier when clamping or measuring.

6. Demagnetizing switch (DEMAG)

This can demagnetize the core if it has been magnetized by switching the power on and off, or by an excessive input. Always carry out demagnetizing before measurement.

Moreover, the demagnetizing process takes about 3 second. During demagnetizing, a demagnetizing waveform is output.

7. Zero adjustment dial (ZERO ADJ)

Use the zero adjustment dial to correct for the effect of a voltage offset or temperature drift on the instrument.

When beginning measurement, after demagnetizing always carry out zero adjustment

8. Output connector

The current waveform of the measured conductor is output at a constant rate (0.01 V/A).

Connect to the BNC input connector of the waveform measuring instrument.

NOTE

- The output of this instrument is terminated internally. Use the waveform measuring instrument with high impedance input. With an input impedance of 50 Ω , accurate measurement is not possible.
- If using BNC-banana plug adapters or similar to connect to input terminals other than BNC connectors, make sure the polarity is correct.
- Turn the collar of output connector until it clicks, and check that it is locked securely.

9. Power plug

Connect this to the power receptacle of PS-52 or PS-54 POWER SUPPLY to supply power to the sensor part or the terminator part.

Memo

2 Specifications

2.1 Instrument Specifications (SS-560)

The following values indicate unit performance 30 minutes after the power has been turned on in an ambient environment of $23^{\circ}\text{C} \pm 3^{\circ}\text{C}$ and below the moisture of 80 %RH (no dew condensation).

Bandwidth	DC to 10 MHz (-3 dB) (Typical characteristics shown in Fig.1)
Rise time	35 ns or less
Maximum continuous input current range	150 Arms (Derating according to frequency shown in Fig.2)
Maximum peak current value	Non-continuous 300 Apeak 500 Apeak at pulse width $\leq 30 \mu\text{s}$
Output voltage rate	0.01 V/A
Amplitude accuracy	To 150 Arms: $\pm 1.0\%$ rdg. ± 1 mV 150 Arms to 300 Apeak: $\pm 2.0\%$ rdg. (DC or 45 to 66 Hz)
Noise	Equivalent to 25 mArms or less (for measuring instrument with 20 MHz bandwidth)
Input impedance	(Typical characteristics shown in Fig.3)
Temperature characteristic of sensitivity	$\pm 2\%$ or less (Input: 55 Hz, 150 Arms, within a range of 0 to 40°C)
Maximum power consumption	5.5 VA or less (within maximum continuous input range)
Rated power supply voltage	DC ± 12 V ± 1 V
Operating temperature range	0 to 40°C (no dew condensation)
Operating humidity range	Below the moisture of 80 %RH
Storage temperature range	-10 to 50°C (no dew condensation)
Storage humidity range	Below the moisture of 80 %RH
Location for use	Indoor, altitude up to 2000 m, Pollution Degree 2
Accuracy warranty period	1 year (Opening/Closing up to 10,000 times)
Product warranty period	1 year
Effect of external magnetic fields	Equivalent to a maximum of 150 mArms (in DC or 60Hz and 400 A/m of AC magnetic field)

2 Specifications

Measurable conductor	Only for Insulated target conductor
Diameter of measurable conductors	φ20 mm or less
Cable or cord lengths	Sensor cable: 2.0 m ±0.1 m Power cord: 1.0 m ±0.1 m
External dimensions	Sensor part: 176(W) X 69(H) X 27(D) mm (±2 mm) Terminator part: 27(W) X 55(H) X 18(D) mm (±2 mm)
Weight	500 g ±20 g
Accessories	Hard case (1), Instruction manual (1), Sheet for China RoHS (1), Cable tie (1)

2.2 Certification Standards (SS-560)

Safety	EN61010-2-032
EMC	EN61326-1

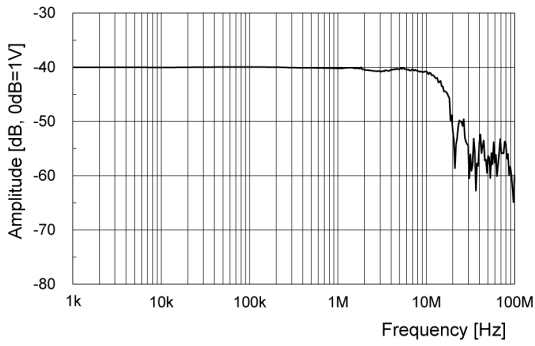

Fig.1 Frequency characteristics (SS-560, Typical characteristics)

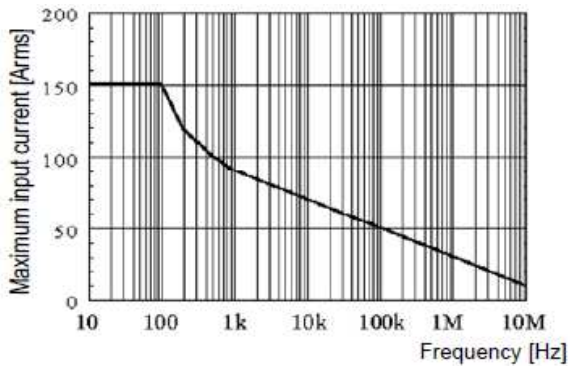

Fig.2 Derating according to frequency (SS-560)

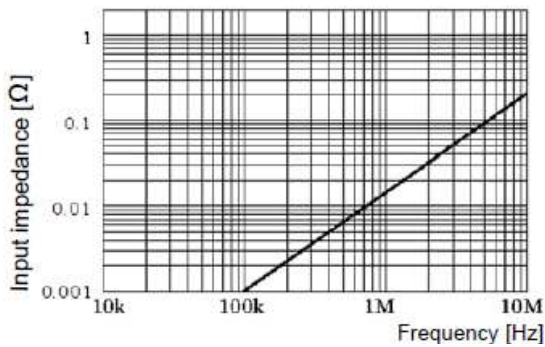

Fig.3 Input impedance (SS-560, Typical characteristics)

2.3 Instrument Specifications (SS-570)

The following values indicate unit performance 30 minutes after the power has been turned on in an ambient environment of $23^{\circ}\text{C} \pm 3^{\circ}\text{C}$ and below the moisture of 80 %RH (no dew condensation).

Bandwidth	DC to 2 MHz (-3 dB) (Typical characteristics shown in Fig.4)
Rise time	175 ns or less
Maximum continuous input current range	500 Arms (Derating according to frequency shown in Fig.5)
Maximum peak current value	Non-continuous 700 Apeak;
Output voltage rate	0.01 V/A
Amplitude accuracy	To 500 Arms: $\pm 1.0\%$ rdg. ± 5 mV 500 Arms to 700 Apeak: $\pm 2.0\%$ rdg. (DC or 45 to 66 Hz)
Noise	Equivalent to 25 mArms or less (for measuring instrument with 20 MHz bandwidth)
Input impedance	(Typical characteristics shown in Fig.6)
Temperature characteristic of sensitivity	$\pm 2\%$ or less (Input: 50 Hz, 500 Arms, within a range of 0 to 40°C)
Maximum power consumption	7.2 VA or less (within maximum continuous input range)
Rated power supply voltage	DC ± 12 V ± 0.5 V
Operating temperature range	0 to 40°C (no dew condensation)
Operating humidity range	Below the moisture of 80 %RH
Storage temperature range	-10 to 50°C (no dew condensation)
Storage humidity range	Below the moisture of 80 %RH
Location for use	Indoor, altitude up to 2000 m, Pollution Degree 2
Accuracy warranty period	1 year (Opening/Closing up to 10,000 times)
Product warranty period	1 year
Effect of external magnetic fields	Equivalent to a maximum of 800 mA (in DC or 60Hz and 400 A/m magnetic field)
Measurable conductor	Only for Insulated target conductor

Diameter of measurable conductors	$\phi 20$ mm or less
Cable or cord lengths	Sensor cable: 2.0 m ± 0.1 m Power cord: 1.0 m ± 0.1 m
External dimensions	Sensor part: 176(W) X 69(H) X 27(D) mm (± 2 mm) Terminator part: 27(W) X 55(H) X 18(D) mm (± 2 mm)
Weight	500 g ± 20 g
Accessories	Hard case (1), Instruction manual (1), Sheet for China RoHS (1), Cable tie (1)

2.4 Certification Standards (SS-570)

Safety	EN61010-2-032
EMC	EN61326-1

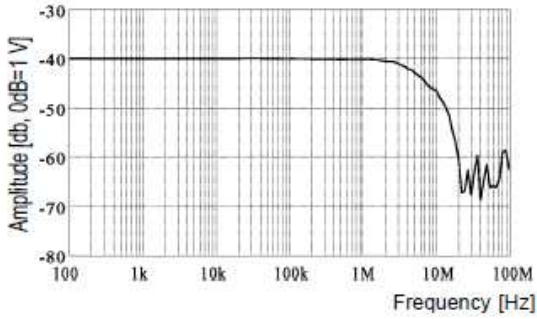

Fig.4 Frequency characteristics (SS-570, Typical characteristics)

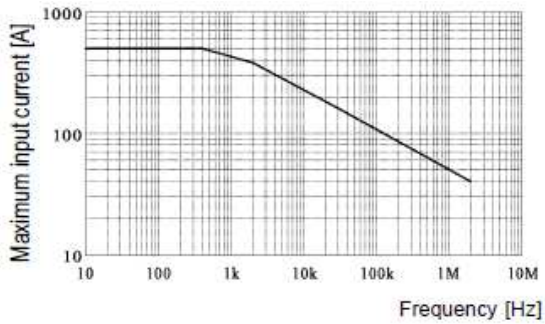

Fig.5 Derating according to frequency (SS-570)

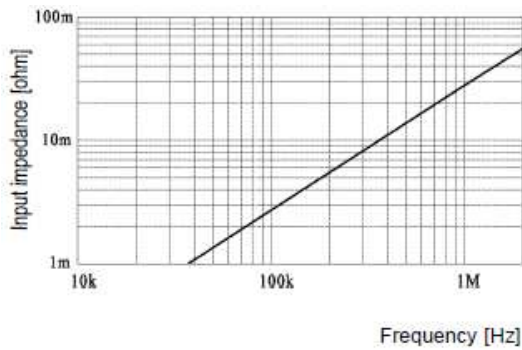

Fig.6 Input impedance (SS-570, Typical characteristics)

3 Measurement Procedure

3.1 Notes on Use



To avoid short circuits and potentially life-threatening hazards, follow these precautions.

- Be sure to use this instrument on an insulated circuit. Moreover, do not use it for the bare conductor.
- Be careful to avoid damaging the insulation surface of the insulated target conductor to be measured.
- This instrument is made for use with PS-52 or PS-54 POWER SUPPLY. It is possible to use a power supply other than PS-52 and PS-54, provided that the connector and pin assignments match, and that voltage and other electrical specifications are satisfied. Even in that case for safety, make sure that the power supply has a protective earth.
- Be sure to observe all operating precautions for the waveform monitoring instrument (oscilloscope or recorder) and other measurement instruments to which this instrument is connected

3.2 Preparations for Measurement

- (1) Have this instrument, the power supply (PS-52 etc.) and oscilloscope or recorder for waveform measurement ready.

CAUTION

Before turning on the power, make sure that the voltage of the power supply being used matches the supply voltage indicated on the rear panel of the PS-52 or PS-54. Damage and the electric accident of the PS-52 or PS-54 power supply will become when using it outside the specified power-supply voltage range.

NOTE

- The output of this instrument is terminated internally. Use a high impedance input to the measuring instrument. With an input impedance of 50 Ω , accurate measurement is not possible.
- Depending on the current value being measured, there are cases in which these two instruments cannot be used simultaneously on the power supply (PS-52 etc.). Power consumption on this instrument depends on the current value being measured.

- (2) Turn the power switch off and connect the power cord.

- (3) Connect the power plug of this instrument to the power receptacle of the power supply (PS-52 etc.).

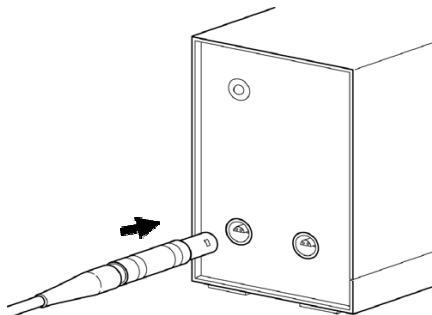

- (4) When PS-52 or PS-54 is used, turn the PS-52 or PS-54 power switch on, and check that the front panel power indicator lights.

3.3 Demagnetizing and Zero Adjustment

- (1) With the waveform measurement instrument input at ground, adjust the trace to the zero position.
- (2) Set the input coupling of the waveform measurement instrument to DC.
- (3) Connect the output connector of this instrument to the input connector of the waveform measurement instrument. Turn the collar until it clicks, and check that it is locked securely.

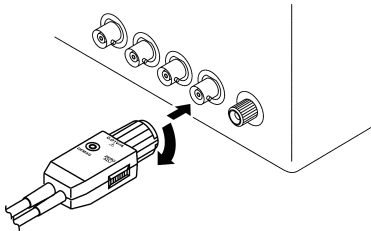

CAUTION

- When disconnecting the output connector, be sure to release the lock before pulling out the connector. Forcibly pulling the connector without releasing the lock, or pulling on the cable, can damage the terminator.
- When inputting the signal into input terminals other than BNC connectors, make sure the polarity is correct.
- Do not demagnetize while this instrument is clamping an insulated target conductor to be measured. Demagnetizing causes current to flow into the insulated target conductor to be measured, which may damage parts in the circuit to be measured.

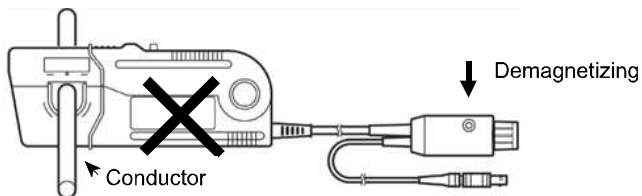

- Check that the insulated target conductor to be measured is not clamped when supplying power to this instrument for the same reason. Demagnetized waveforms may generate electric power when supplying electric power.

- (4) Before clamping an insulated target conductor to be measured, confirm that the clamp can be securely closed: press the slider until UNLOCK is no longer displayed, and hold it until LOCK appears.
- (5) Press the demagnetizing switch (DEMAG) on the terminator.
- (6) Turn the zero adjustment dial on the terminator to adjust the trace to the zero position.

3.4 Measurement Procedure

- (1) Check that the system is safe, and that the preparations described in the preceding section have been carried out.
- (2) Pull the sensor slider so that the clamp opens.
- (3) Clamp so that direction of arrow of electric current direction mark displayed in sensor assembly point corresponds to the direction of current flow through the insulated target conductor to be measured, and so that the insulated target conductor to be measured is in the center of the clamping window.

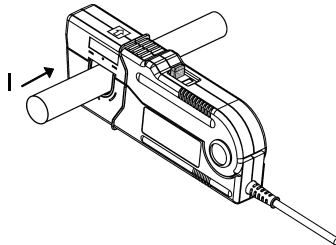

- (4) Press the slider on the sensor head until the "UNLOCK" indication disappears, and hold it until LOCK appears, and check that the opening lever is firmly locked and the clamp securely closed.
- (5) It is now possible to monitor the current waveform by the waveform measurement instrument. The output rate of this instrument is 0.01 V/A. The current sensitivity can be derived from the voltage sensitivity of the waveform measurement instrument. For example, if the voltage sensitivity is 10mV/DIV, the current sensitivity is 1 A/DIV.

NOTE

- When using this instrument, note that these two instruments may not be used simultaneously with the PS-52 POWER SUPPLY, depending on the current to be measured.
- The current consumption of this instrument depends on the current value to be measured. Confirm that the total current consumption of this instrument does not exceed the current of 600 mA. See Figure 7 (for SS-560) or Figure 8 (for SS-570).

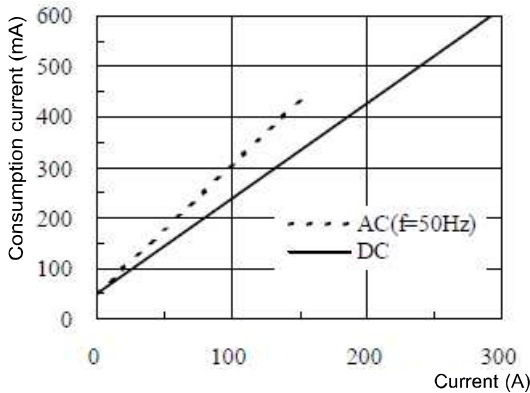

Fig.7 Current consumption* vs. current to be measured (typical for SS-560)
*The sum total of a positive and negative current consumption

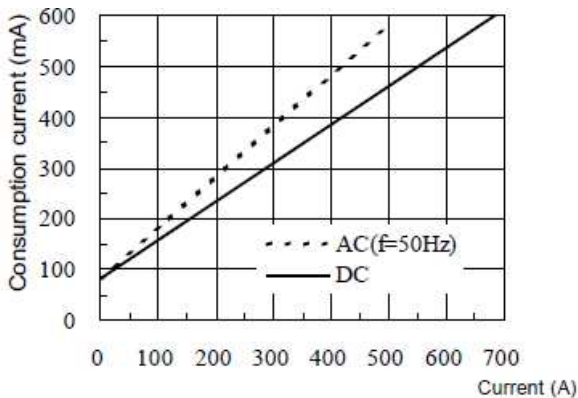

Fig.8 Current consumption* vs. current to be measured (typical for SS-570)
*The sum total of a positive and negative current consumption



- The maximum continuous input range is based on heat that is internally generated during measurement. Never input current in excess of this level. Exceeding the rated level may result in damage to this instrument.
 - The maximum continuous input range varies according to the frequency of the current to be measured. See the figures in Chapter 2, "Specifications"
 - If the current that exceed the maximum continuous input range is input, generated heat activates a built-in safety function that blocks normal output. If this happens, remove the input immediately (remove the sensor from the insulated target conductor to be measured, or reduce the input current to zero).
Wait until the sensor has had sufficient time to cool before resuming operation.
 - Even if the input current does not exceed the rated continuous maximum, continuous input for an extended period of time may result in activation of the safety circuit to prevent damage resulting from heating of the sensor.
 - At high ambient temperatures, the built-in safety circuit may activate at current input levels below the maximum continuous input range.
 - Continuous input of current exceeding the maximum continuous input range or repeated activation of the safety function may result in damage to this instrument.
-

CAUTION

- These two instruments are rated for the maximum peak current under the conditions shown in the Instrument Specifications in addition to the maximum input range. These are the following.

<SS-560>

(1) 300 A_{peak}, for non-continuous input

(2) 500 A_{peak} for pulse widths $\leq 30 \mu\text{s}$

<SS-570>

(1) 700 A_{peak}, for non-continuous input

(1) indicates an upper waveform response limit of 300 A_{peak} (for SS-560) / 700 A_{peak} (for SS-570). Use the sensor at RMS current input levels that are within the maximum continuous input range. (2) indicates the upper response limit for a single input pulse. Do not allow current level to exceed the specified limit of the operating range.

- To avoid damage to this instrument, when opening the clamp of the probe, be sure to operate with the slider.
- Do not place any unclamped conductor with an electric current of a frequency of 10 kHz or more near the sensor head. Current flowing in the conductor nearby may heat up the sensor head and cause its temperature to rise, leading to damage to the sensor. For example, when one side of a go and return conductor is clamped and the other side is also placed near the sensor head as shown in the diagram, even if the electric current is lower than the maximum continuous current, electric currents in both sides will heat up the wires and raise the temperature, thereby causing damage to the sensor.

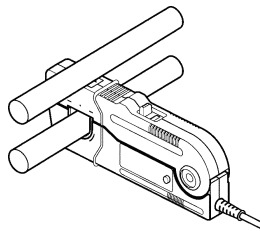

NOTE

- The output of this instrument is terminated internally. Use a waveform measurement instrument with an input impedance of at least 1 M Ω .
- Immediately after powering on, this instrument may be subject to an appreciable offset drift due to the effect of self-heating. To counteract this, allow the instrument to warm up for about 30 minutes before carrying out measurement.
- When performing continuous measurements, it is necessary to be aware that the offset voltage drifts, depending on factors such as the ambient temperature.
- Under certain circumstances, oscillation may occur if the probe is connected to the PS-52 or PS-54 POWER SUPPLY while the power supply is on. This does not indicate a malfunction.
Oscillation can be stopped and operation restored to normal by opening and closing the clamp.
- Acoustic resonance may occur depending on the level and frequency of the measured current. This does not normally affect measurements unless a foreign substance such as dust is present on the contact surfaces of the sensor head.
- The reading may be affected by the position within the clamp aperture of the insulated target conductor to be measured. The insulated target conductor to be measured should be in the center of the clamp aperture.
- When carrying out measurement, press the slider on the sensor head until the "UNLOCK" indication disappears, and hold it until LOCK appears, and check that the opening lever is firmly locked and the clamp securely closed. Correct measurements cannot be performed unless the clamp is securely closed and the slider is pressed until LOCK is displayed.
- At high frequencies, common mode noise may affect measurements taken on the high voltage side of circuits. If this occurs, reduce the frequency range of the waveform measuring instrument, or clamp onto the low-voltage side of the circuit, as appropriate.

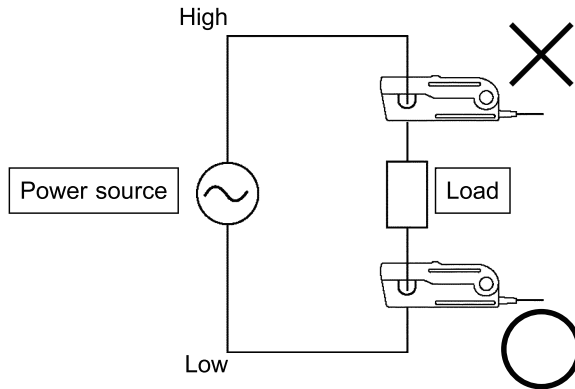
**NOTE**

- When power is turned on, a demagnetizing waveform is initially applied to the output: this is not a fault.
- Accurate measurement may be impossible in locations subject to strong external magnetic fields, such as transformers and high current conductors, or in locations subject to strong external electric fields, such as radio transmission equipment.

Appendix

Appendix 1 Recommended power supply and oscilloscope

The following Iwatsu Instruments are recommended for use with this instrument.

- Recommended power supply

PS-52, PS-54

- Recommended oscilloscope

Probe power PS-52 or PS-54 becomes unnecessary if Probe power option DS-579 (Use the instrument within the range where the total of the current consumption of it is 750mA or less.) of product of our company that can be used as power supply for probe, Digital oscilloscope ViewGoll series that can attach DS-579, and power connector conversion cable are used together, and it is possible to use them slimly and compactly.

If you have any questions about this instrument, contact IWATSU or our sales distributors.

MEMO

IWATSU ELECTRIC CO., LTD.

Contact Us

Overseas Sales Sect., Sales Dept. No.2

Address : 1-7-41 Kugayama, Suginami-ku, Tokyo 168-8501, Japan

Phone : +81 3 5370 5483

Facsimile : +81 3 5370 5492

Web Site : http://www.iti.iwatsu.co.jp/index_e.html

E-mail : info-tme@iwatsu.co.jp