

# Keysight N7026A 150 MHz AC/DC High Sensitivity Current Probes

User's  
Guide



Distributed by:

Sie haben Fragen oder wünschen eine Beratung? Angebotsanfrage unter +49 7121 / 51 50 50 oder über [info@datatec.eu](mailto:info@datatec.eu)

**dataTec**

# Notices

© Keysight Technologies, Inc. 2017, 2018, 2020, 2021

No part of this manual may be reproduced in any form or by any means (including electronic storage and retrieval or translation into a foreign language) without prior agreement and written consent from Keysight Technologies, Inc. as governed by United States and international copyright laws.

## Manual Part Number

N7026-97001

## Edition

Fourth Edition, October 2021

Published by:  
Keysight Technologies, Inc.  
1400 Fountaingrove Parkway  
Santa Rosa, CA, 95403

## Warranty

The material contained in this document is provided “as is,” and is subject to being changed, without notice, in future editions. Further, to the maximum extent permitted by applicable law, Keysight disclaims all warranties, either express or implied, with regard to this manual and any information contained herein, including but not limited to the implied warranties of merchantability and fitness for a particular purpose. Keysight shall not be liable for errors or for incidental or consequential damages in connection with the furnishing, use, or performance of this document or of any information contained herein. Should Keysight and the user have a separate written agreement with warranty terms covering the material in this document that conflict with these terms, the warranty terms in the separate agreement shall control.

## Technology Licenses

The hardware and/or software described in this document are furnished under a license and may be used or copied only in accordance with the terms of such license.

## U.S. Government Rights

The Software is “commercial computer software,” as defined by Federal Acquisition Regulation (“FAR”) 2.101. Pursuant to FAR 12.212 and 27.405-3 and Department of Defense FAR Supplement (“DFARS”) 227.7202, the U.S. government acquires commercial computer software under the same terms by which the software is customarily provided to the public. Accordingly, Keysight provides the Software to U.S. government customers under its standard commercial license, which is embodied in its End User License Agreement (EULA), a copy of which can be found at <http://www.keysight.com/find/sweula>. The license set forth in the EULA represents the exclusive authority by which the U.S. government may use, modify, distribute, or disclose the Software. The EULA and the license set forth therein, does not require or permit, among other things, that Keysight: (1) Furnish technical information related to commercial computer software or commercial computer software documentation that is not customarily provided to the public; or (2) Relinquish to, or otherwise provide, the government rights in excess of these rights customarily provided to the public to use, modify, reproduce, release, perform, display, or disclose commercial computer software or commercial computer software documentation. No additional government requirements beyond those set forth in the EULA shall apply, except to the extent that those terms, rights, or licenses are explicitly required from all providers of commercial computer software pursuant to the FAR and the DFARS and are set forth specifically in writing elsewhere in the EULA. Keysight shall be under no obligation to update, revise or otherwise modify the Software. With respect to any technical data

as defined by FAR 2.101, pursuant to FAR 12.211 and 27.404.2 and DFARS 227.7102, the U.S. government acquires no greater than Limited Rights as defined in FAR 27.401 or DFAR 227.7103-5 (c), as applicable in any technical data.

## Safety Notices

### CAUTION

A **CAUTION** notice denotes a hazard. It calls attention to an operating procedure, practice, or the like that, if not correctly performed or adhered to, could result in damage to the product or loss of important data. Do not proceed beyond a **CAUTION** notice until the indicated conditions are fully understood and met.

### WARNING

A **WARNING** notice denotes a hazard. It calls attention to an operating procedure, practice, or the like that, if not correctly performed or adhered to, could result in personal injury or death. Do not proceed beyond a **WARNING** notice until the indicated conditions are fully understood and met.

### DANGER

A **DANGER** notice that incorrect operation presents extreme danger of accident resulting in death or serious injury to the user.

# Contents

Introduction	/ 5
AutoProbe Interface	/ 5
External Power Supply	/ 5
Operating Modes	/ 5
Auto Demagnetization (Degauss) and Calibration	/ 6
N7026A Kit Components	/ 7
Characteristics and Specifications	/ 10
Compatibility with Oscilloscopes	/ 12
Inspecting the Probe	/ 13
Cleaning the Probe	/ 14
Cleaning the Sensor Head	/ 14
Safety Information	/ 15
Powering the Probe	/ 17
Using the External DC Power Supply	/ 17
Input Current Limits for N7026A	/ 19
Factors Impacting N7026A Maximum Continuous Current Range	/ 19
Built-in Safety Function of N7026A	/ 21
Setting up the Probe	/ 23
Obtaining the Best Measurement Accuracy	/ 27
Installing and Removing Bushing	/ 28
Performing Demagnetization and Zero Offset	/ 30
Performance Verification for N7026A	/ 32
Procedure	/ 32

## Contents

Plots / 37

Product Markings and Labels / 40

Service Strategy / 41

To return the Probe to Keysight Technologies for Service / 41

Index

# N7026A 150 MHz AC/DC High Sensitivity Current Probes User's Guide

## Introduction

The N7026A is a wide-band, DC to 150 MHz, clamp-on active current probe. It is ideal for acquiring high transient time signals such as those found in motor controllers, in switching power supplies, and in current amplifiers driving inductive loads.

This high bandwidth, high sensitivity (1V/A), and low noise probe enables you to achieve a high degree of precision even while measuring very low-current waveforms.

The following sections briefly describe the key features of this probe.

## AutoProbe Interface

The probe's output connector has the AutoProbe interface that allows it to connect directly to a Keysight InfiniiVision or Infiniium oscilloscope that has 1 M $\Omega$  AutoProbe connector. The oscilloscope's AutoProbe interface provides the probe power, probe offset, and auto configuration of probe type and attenuation setting on connection.

## External Power Supply

The probe also comes with an external power supply adapter that allows you to use this probe to measure large amplitude currents (upto  $\pm 30 A_{RMS}$ ).

See ["Using the External DC Power Supply"](#) on page 17 for details.

## Operating Modes

The probe can operate in the following two modes as per the attenuation setting automatically configured and switched by the oscilloscope.

- **High-sensitivity mode** - The probe's attenuation is 1V/A with 10x gain amplifiers to enable higher sensitivity current measurements. The oscilloscope automatically switches the probe's attenuation to high-sensitivity if the Amps/division scale of the channel is equal to or less than 200mA/div.
- **Low-sensitivity mode** - The probe's attenuation is 0.2V/A without any modifications to the signal. The oscilloscope automatically switches the probe's attenuation to low-sensitivity if the Amps/division scale of the channel is greater than 200mA/div.

## Auto Demagnetization (Degauss) and Calibration

The probe's auto demagnetization (degauss) and calibration features remove any residual magnetism and unwanted DC offset in the probe.

The probe has the following operating regions that provide a wide, flat frequency response.

- In the DC to low frequency AC region, the probe operation is based on the negative feedback system that includes the thin film Hall element as a detector.
- In the high frequency region, the probe operates as a current transformer.

To use this probe effectively and to ensure a long operational life, read this user's guide carefully and retain it for future reference.

# N7026A Kit Components

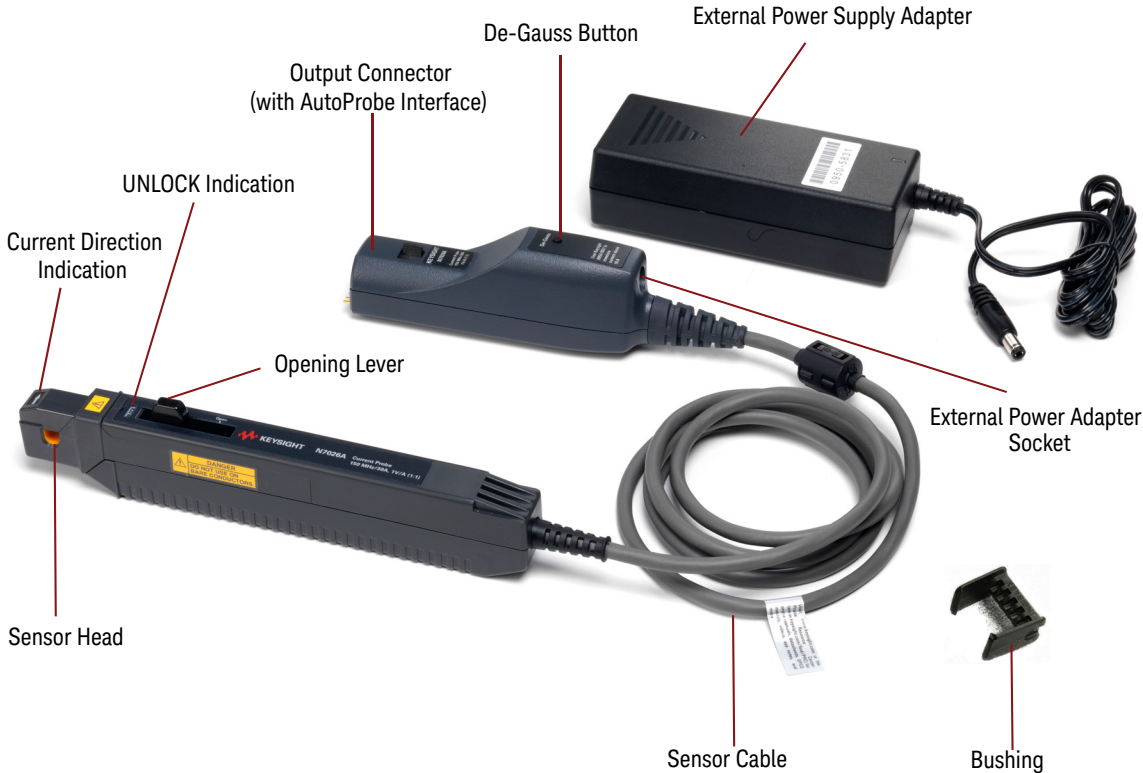

Figure 1 N7026A Kit Components

## N7026A Probe

Component	Description
Sensor Head	<p>The sensor head clamps the conductor being measured, detects the current, and carries out the current measurement. It is a precision assembly including a molded component, a ferrite core, and a Hall effect element.</p> <p><b>CAUTION</b> The sensor head may be damaged if subjected to sudden changes in ambient temperature, or mechanical strain or shock. Care should be exercised when handling the sensor head.</p>
Current Direction Indication	Indicates the direction of the current flow through the conductor under test.
UNLOCK Indication	<p>When you pull the probe's opening lever to open the sensor head, the UNLOCK indication is displayed on the sensor head. It means that the sensor head is currently in the unlocked / open state.</p> <p>When you slide the opening lever towards the front of the sensor head and the UNLOCK indication disappears, it means that the sensor head is currently in the locked / closed state.</p>
Opening Lever	Operating lever for opening the sensor head. Always use this lever to open the sensor head to avoid damaging the open-close mechanism of the sensor head.
Output Connector	The pod with the AutoProbe interface to connect the probe to one of the channels of a compatible oscilloscope.
De-Gauss Button	<p>The button to demagnetize the core if it has been magnetized by switching the power on and off, or by an excessive input. Always carry out demagnetization before making measurements. The probe should be connected to the oscilloscope for the demagnetizing process. This process takes about one second. During demagnetizing, a demagnetizing waveform is output.</p> <p>Refer to "<a href="#">Performing Demagnetization and Zero Offset</a>" on page 30" to know more.</p>
External Power Supply Adapter	<p>The power supply adapter (part number 0950-5831) is included with the probe to power the probe using an external DC supply.</p> <p>Refer to the topic "<a href="#">Powering the Probe</a>" on page 17 to know more.</p>



Component	Description
External Power Adapter Socket	Jack DC socket to connect the probe to the power supply adapter shipped with the probe. You use this option to power the probe using an external DC supply which allows the probe to measure $\pm 30A_{RMS}$ . Refer to the topic " <a href="#">Powering the Probe</a> " on page 17 to know when to use the external power supply for the probe.
Bushing	Recommended for use in the probe's sensor aperture to minimize the measurement variation caused by the position variation of the conductor under test within the sensor aperture. Refer to the topic " <a href="#">Installing and Removing Bushing</a> " on page 28 to know more.
Sensor Cable	The cable that connects the probe's sensor to the output pod. <b>CAUTION</b> To avoid damaging the cable, do not tightly bend or pull the cable.

## Characteristics and Specifications

**Table 1** Measurement Characteristics

Item	Characteristic <sup>a</sup>
Probe Bandwidth (-3 dB)	DC to 150 MHz
Amplitude Accuracy <sup>b</sup>	±1% of reading ±1 mV (DC or 45 Hz to 66 Hz, with calibrated gain factor) ± 1% of reading. ±5 mA to 30 A <sub>rms</sub> (including calibration scale factor of oscilloscope measured at DC or 45 to 66 Hz.)
Rise Time (calculated, 10% to 90%)	2.67 ns <i>(Rise time is calculated as: <math>T_r = 0.4/\text{Bandwidth}</math>)</i>
Maximum Continuous Current	See <b>"Input Current Limits for N7026A"</b> on page 19. 
Maximum Non-continuous Peak Current (for Pulse Widths ≤ 10μs)	See <b>"Input Current Limits for N7026A"</b> on page 19.
Probe Sensitivity	1 V/A and 0.2 V/A <i>(automatically configured and switched by the oscilloscope)</i>
Noise	≤ 250 μA <sub>rms</sub> (for 20 MHz bandwidth measuring instrument)
Insertion Impedance	See <b>Figure 16</b> on page 38.
Temperature Coefficient	±2% or less (within a range of 0°C to 40°C or 32 to 104 °F)
Effect of External Magnetic Fields	Equivalent to a maximum of 20 mA (in a DC to 60 Hz, 400 A/m magnetic field)
Maximum Rated Power	3 VA (with rated current)
Minimum oscilloscope vertical scale	1 mA/div
Maximum Number of Probes Supported	2 (for use with 3000XT series oscilloscopes without external power adapter) 4 (for use with 3000XT series oscilloscopes with external power adapter) 2 (for use with 9000 series oscilloscopes) 4 (for use with 4000X, 6000X, S-Series oscilloscopes)

**a** Requires 1MΩ termination. Valid for 23°C ±3°C (73°F ±5°F), at least 30 minutes after power on.

**b** This is a specification and is guaranteed at 23°C ±3°C (73°F ±5°F).

**Table 2** Power Supply Characteristics

Item	Characteristics
DC Supply Voltage Requirements	$\pm 12$ Vdc $\pm 1$ V
Probe Power Consumption	Increases with measured current. 3 VA when measuring 15 A

**Table 3** Mechanical Characteristics

Item	Characteristics
Maximum Diameter of Measurable Conductors	5 mm (0.2 in.)
Sensor Cable Length	1.5 m (59.0 in.)
Dimensions (Sensor)	175 mm x 18 mm x 40 mm 6.89 in. x 0.71 in. x 1.6 in.
Dimensions (Output Pod)	28 mm x 39 mm x 145 mm 1.1 in. x 1.5 in. x 5.7 in.
Probe Interface	AutoProbe Interface (1 M $\Omega$ terminated)
Weight	275 g (9.7 oz.)
Accessories Supplied	Storage case, calibration certificate, power supply adapter, bushing kit

**Table 4** Environmental Characteristics

Item	Characteristics
Use	Indoor
Operating Temperature Range	0 °C to 40 °C (32 °F to 104 °F)
Storage Temperature Range	-10 °C to 50 °C (14 °F to 122 °F)
Maximum Relative Humidity (Operating or Storage)	80% (no condensation)
Maximum Altitude	2000 m

## Compatibility with Oscilloscopes

**NOTE**

You can use these probes with any Keysight Infiniium or InfiniiVision oscilloscope that has the following features.

- Minimum input impedance of 1 MΩ
- AutoProbe connector

InfiniiVision Oscilloscopes	InfiniiVision Software Version
3000T X Series	7.20 or higher
3000A X-Series	
4000 X Series	
6000 X-Series	

Infiniium Oscilloscopes	Infiniium Software Version
S-Series	6.10 or higher
9000 Series	
9000H Series	
MXR-Series	11.06.00401 or higher
EXR-Series	

## Inspecting the Probe

- Inspect the shipping container for damage.
- Keep the damaged shipping container or cushioning material until the contents of the shipment have been checked for completeness and the probe has been checked mechanically and electrically.
- Check the accessories. If the contents are incomplete or damaged, notify your Keysight Technologies Sales Office.
- Inspect the probe. If there is mechanical damage or defect, or if the probe does not operate properly or pass calibration tests, notify your Keysight Technologies Sales Office.
- If the shipping container is damaged, or the cushioning materials show signs of stress, notify the carrier as well as your Keysight Technologies Sales Office. Keep the shipping materials for the carrier's inspection. The Keysight Technologies office will arrange for repair or replacement at Keysight Technologies' option without waiting for claim settlement.

## Cleaning the Probe

You should inspect and clean the probe regularly to prevent any surface contamination. If the probe requires cleaning:

- 1 Disconnect the probe from the oscilloscope, external power supply, and any circuit under test.
- 2 Gently clean the probe with a soft cloth dampened with a mild soap and water solution.
- 3 Wipe with clean water to remove the detergent and then dry thoroughly with a clean cloth.

### **WARNING**

**Do not try to clean the probe using cleaners containing organic solvents such as benzene, alcohol, acetone, ether, ketones, thinners, or gasoline. These may cause discoloration or damage. Make sure the probe is completely dry before reconnecting it for use.**

---

## Cleaning the Sensor Head

The presence of foreign substances such as dust on the mating surfaces of the probe's sensor head can cause acoustic resonance and degraded measurements. Therefore, keep these mating surfaces clean by gently wiping with a soft cloth.

## Safety Information

This manual provides information and warnings essential for operating this equipment in a safe manner and for maintaining it in safe operating condition. Before using this equipment, be sure to carefully read the following safety notes.

### WARNING

This equipment is designed according to IEC 61010-1 Safety Standards, and has been tested for safety prior to shipment. Incorrect measurement procedures could result in injury or death, as well as damage to the equipment. Please read this manual carefully and be sure that you understand its contents before using the equipment. The manufacturer disclaims all responsibility for any accident or injury except that resulting due to defect in its product.

---

### WARNING

Do not install substitute parts or perform any unauthorized modification to the instrument. Only Keysight service centers should perform repair/maintenance on the equipment.

---

### DANGER



To avoid short circuits and accidents that could result in injury or death, use the probe only with insulated power lines carrying 300V or less.

---

### DANGER



Never use this sensor on uninsulated conductors. The core and shield case are not insulated. Before clamping the insulated conductor being measured, make sure that the insulation on the conductor is undamaged. Any damage to the insulation can cause an electric shock.

---

### WARNING



Ensure that the input does not exceed the maximum rated current to avoid device damage, short circuiting, and electric shock.

---

### WARNING

Do not subject the unit to vibrations or shocks during transport or handling. Be especially careful to avoid dropping the unit.

---

**WARNING**

Do not store the unit where it will be exposed to direct sunlight, high temperature, high humidity, or condensation. If exposed to such conditions, the unit may be damaged, the insulation may deteriorate, and the unit may no longer satisfy its specifications.

---

**WARNING**

This unit is not constructed to be dustproof, so do not use it in a very dusty environment.

---

**WARNING**

The sensor head is a precision assembly including a molded component, a ferrite core, and a Hall effect element. It may be damaged if subjected to sudden changes in ambient temperature, or mechanical strain or shock, and therefore great care should be exercised in handling it.

---

**WARNING**

To avoid scratching the surfaces of the Hall effect elements, keep the core section of the sensor closed, except when clamping it around the insulated conductor to be measured.

---

**WARNING**

Before turning on the instrument, you must connect the protective earth terminal of the instrument to the protective conductor of the (mains) power cord. The mains plug shall only be inserted in a socket outlet provided with a protective earth contact. You must not negate the protective action by using an extension cord (power cable) without a protective conductor (grounding).

---



## Powering the Probe

You can power the N7026A probe in the following two ways:

**Table 5** Powering the N7026A Probe

Using the Oscilloscope's AutoProbe Interface	Using the External DC Power Supply
<p>The probe's output connector has AutoProbe 1 interface that allows the probe to automatically receive <math>\pm 12</math> V power supplies from the oscilloscope on connection.</p> <p>With this powering option, the maximum peak current that you can measure is <math>\pm 15</math> A<sub>peak</sub>.</p>	<p>The probe has an external power supply socket and it ships with a power supply adapter to allow you to use an external power supply to power the probe.</p> <p>An external power supply is needed if you want to use the probe to measure currents larger than the maximum peak current you can measure when powering the probe from the oscilloscope.</p> <p>With an external power supply, you can measure the maximum current of <math>\pm 40</math> A<sub>peak</sub>.</p>
<p>When used with the MXR/EXR-series oscilloscopes, the probe supports the maximum peak current 40 A<sub>peak</sub> irrespective of the powering option being used. See <a href="#">"Input Current Limits for N7026A"</a> on page 19 for details.</p>	

### Using the External DC Power Supply

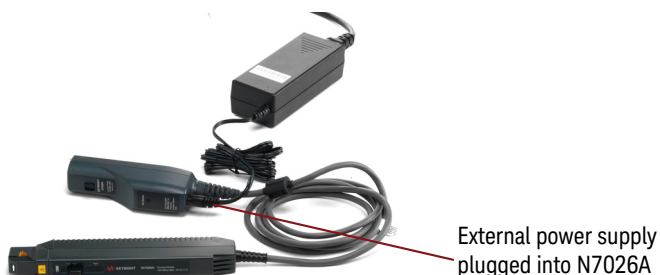

When the external power supply is plugged into the probe, the power supply received from the oscilloscope is automatically disconnected and the external power supply is used. If the AC adapter output voltage is incorrect, the probe will automatically switch to oscilloscope power.

### CAUTION

When the external power supply is connected or removed, it causes a degauss operation that can influence the DUT. It is therefore recommended that you:

- disconnect the probe from the circuit when inserting or removing the DC jack from the probe's external power supply socket.
  - plug the power cord into the outlet and the external power supply adapter prior to inserting the jack into the probe's power supply socket.
-

## Input Current Limits for N7026A

### WARNING

The input current limits and steps provided in this topic must be followed. If the input current exceeds the maximum allowed limits, your probe can give erroneous readings or be damaged.

The input current limits (continuous as well as non-continuous peak) for N7026A vary based on how you are powering the probe. Also, with MXR/EXR oscilloscopes, larger input current limits are allowed irrespective of the powering option being used.

	When using Oscilloscope's AutoProbe interface	When using the external power supply interface
Maximum Continuous Current 	5 A <sub>DC</sub> , 5 A <sub>rms</sub>	30 A <sub>DC</sub> , 30 A <sub>rms</sub>
	With MXR/EXR oscilloscope's main or secondary channels (channel 1 to 8)	
	30 A <sub>DC</sub> , 30 A <sub>rms</sub>	
Maximum Non-continuous Peak Current (for Pulse Widths ≤ 10 μs)	15 A <sub>peak</sub>	40 A <sub>peak</sub>
	With MXR/EXR oscilloscope's main or secondary channels (channel 1 to 8)	
	40 A <sub>peak</sub>	

For pulse widths > 10 μs, N7026A responds according to the *Maximum Continuous Current limits* given above.

## Factors Impacting N7026A Maximum Continuous Current Range

### N7026A Current Consumption

The N7026A's sensor draws current from its power supply in proportion to the current being measured. This is depicted in the graph shown below.

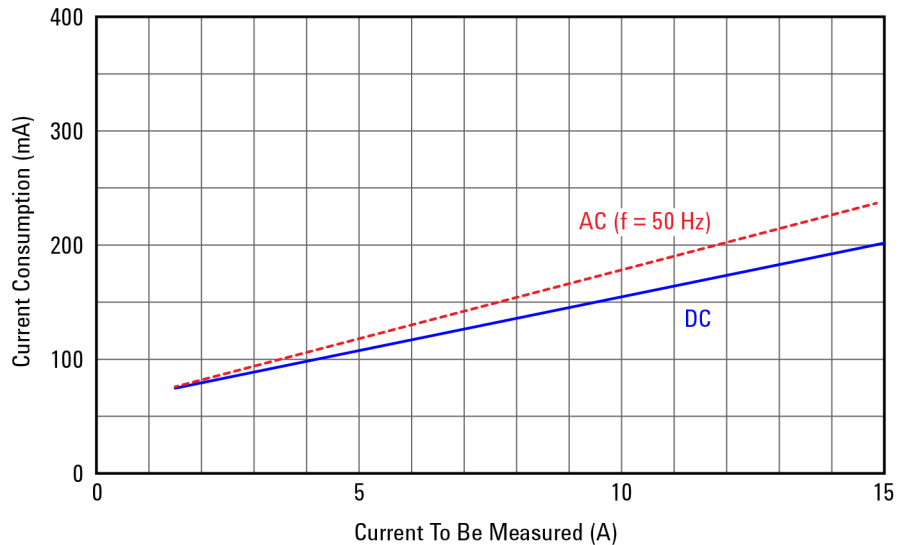
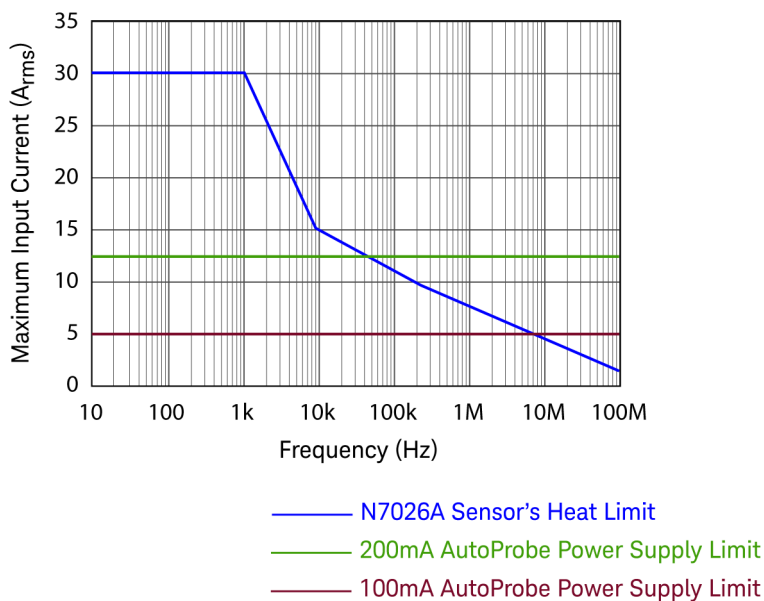

**Figure 2** Typical Current Consumption of the Probe

As the current consumption of N7026A is proportional to the current being measured, it impacts the maximum continuous current range in the following two ways.

- The N7026A's sensor heats up due to current consumption. If the current being measured exceeds the allowed current range, the sensor overheats and can get damaged. This maximum continuous current range is depicted as per sensor's heat limit in [Figure 3](#) and varies according to the frequency of the current being measured.
- If you are powering the probe using the oscilloscope's AutoProbe interface, then the maximum continuous current range is impacted by the current limit that the oscilloscope allows the probe to draw. For example, the AutoProbe power limit is 200mA in S-series Infiniium oscilloscopes. If the current consumption of the probe exceeds the allowed limit of the oscilloscope, it can cause a temporary shutdown of the oscilloscope's power supply for safety. However, oscilloscopes such as MXR or EXR series that support a higher value AutoProbe power limit, this limitation does not impact the continuous current range.

The derating curve shown in [Figure 3](#) relates the maximum continuous current range of the N7026A with the frequency of the current being measured. In this curve, the above-mentioned heat limit of the sensor as well as the oscilloscope's AutoProbe power limits have been included to depict the maximum continuous current range. Use the lower of these two limits as the maximum continuous current range for your specific probing scenario.



**Figure 3** Maximum Continuous Input Current Range of N7026A

## Built-in Safety Function of N7026A

### **WARNING**

In the following situations, the generated heat activates a built-in safety function in the probe that blocks normal output to prevent probe damage resulting from heating.

- If the input current exceeds the maximum continuous input range.
- Continuous input for an extended period of time (even if the input current does not exceed the rated continuous maximum).
- At high ambient temperatures, the built-in safety function may activate even at current input levels below the rated continuous maximum.

In such situations, when the built-in safety function is activated:

- 1 Remove the input immediately (unclamp the sensor from the conductor being measured or reduce the input current to zero).
- 2 Wait until the sensor on the probe had the sufficient time to cool before resuming operation.

When the input current is dropped to within the allowed current range and the probe is allowed to cool down, the normal operation of the probe is restored.

**WARNING**

If there is continuous input of current exceeding the rated continuous maximum or repeated activation of the built-in safety function, it may result in damage to the probe.

---

**WARNING**

Do NOT measure current such that the probe current consumption exceeds the allowable AutoProbe interface current consumption. The excess current consumption causes a temporary shutdown of the oscilloscope's power supply for safety. Quit the measurement and cycle the power of the oscilloscope, if the shutdown occurs. The typical probe current consumption from the AutoProbe interface is shown in [Figure 2](#).

---

## Setting up the Probe

**WARNING**

Ensure all safety warnings and precautions are followed. Before using the probe, read the warnings and precautions in “**Safety Information**” on page 15.

Also, take precautions mentioned in “**Input Current Limits for N7026A**” on page 19.

---

- 1 Power on the oscilloscope.
- 2 Connect the probe to one of the oscilloscope’s channels.



**Figure 4** Connecting the Probe to the Oscilloscope

**NOTE**

When the probe is connected to an oscilloscope channel, the AutoProbe interface recognizes the probe as an N7026A and automatically configures several settings on the channel to which the probe is connected.

For instance, the 1 M $\Omega$  input impedance will be automatically selected on the oscilloscope, as the probe is plugged into the AutoProbe interface. (With an input impedance of 50  $\Omega$ , accurate measurements are not possible.)

Also, the probe output sensitivity 0.2 V/A or 1 V/A will be automatically selected, as the probe is plugged into the AutoProbe interface.

---

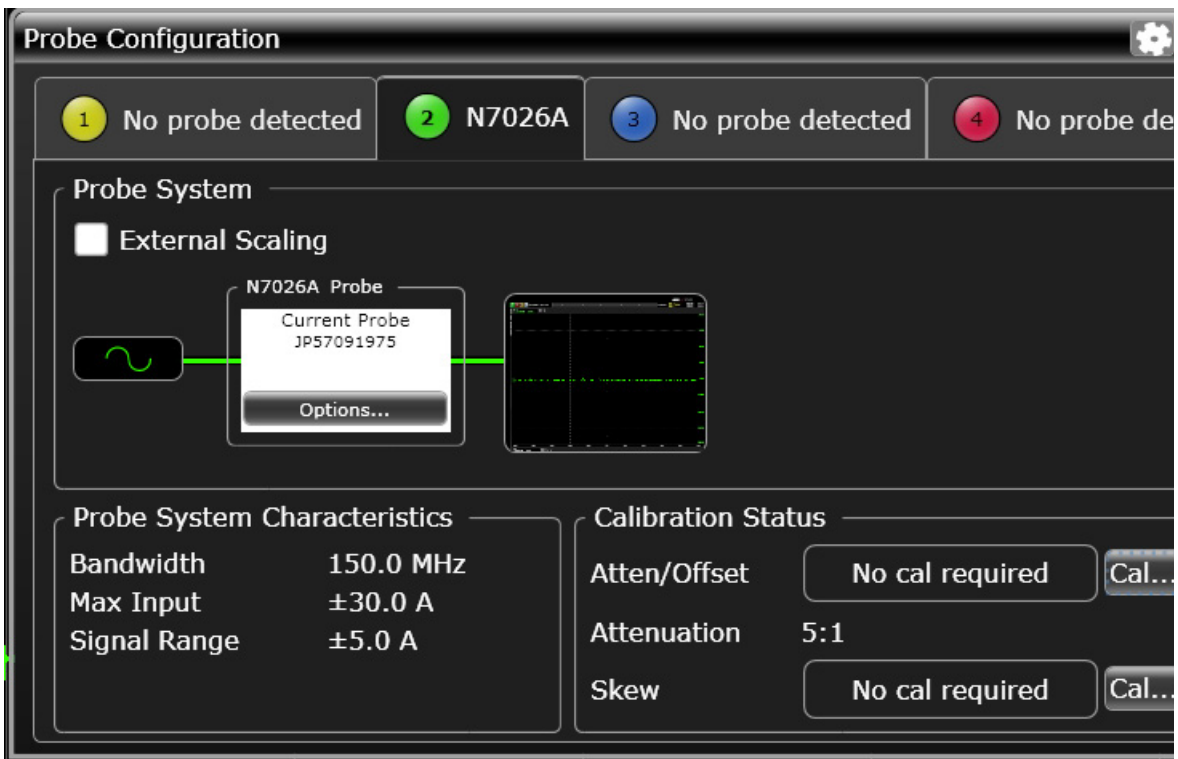

**Figure 5** N7026A probe auto-recognized on an Infiniium oscilloscope on connection

**NOTE**

Immediately after powering on, this probe may be subject to an appreciable offset drift due to the effect of self-heating. To counteract this, allow the probe to warm up for about 30 minutes before carrying out measurements.

- 3 If you want to measure larger currents, connect the probe to an external power supply. Plug the external power adapter shipped with the probe into the external power supply socket on the probe's output connector.





External power supply plugged into N7026A

- 4 Perform the steps described in "Performing Demagnetization and Zero Offset" on page 30. Always carry out demagnetization before making measurements.
- 5 Pull the probe's opening lever to open the sensor head. The UNLOCK indication is displayed on the sensor head. Keep sliding the lever backwards into the Open position.



- 6 With the probe's sensor head around the insulated conductor to be measured, slide the opening lever of the probe towards the front of the sensor head into the **Lock** position. While doing so, ensure that the **UNLOCK** indication disappears which indicates that the sensor head is properly closed. If the sensor head is not closed properly, accurate measurements will not be possible.

**CAUTION**

Always use the opening lever when opening/closing the probe's sensor head. If the upper core is forced to open when the sensor head is locked, the open-close mechanism can be damaged.



**Figure 6** Use the Opening Lever

**NOTE**

Under certain circumstances, oscillation may occur if the probe is connected to the AutoProbe interface while the oscilloscope is on. This does not indicate a malfunction. Oscillation can be stopped and operation can be restored to normal by opening and closing the sensor head.

---

## Obtaining the Best Measurement Accuracy

To obtain the best measurement accuracy, ensure that:

- The current direction indicator on the sensor aligns with the actual current direction in the insulated conductor.
- The sensor opening lever is in the Locked position and the sensor head is properly closed.
- The conductor under test is positioned in such a way that it is in the center of the sensor head aperture.
- Bushing is installed on the probe's sensor aperture if the diameter of the conductor under test including its insulation is less than 1.65mm. Refer to the topic "[Installing and Removing Bushing](#)" on page 28 to know more.
- At high frequencies, common mode noise may affect measurements taken on the high voltage side of circuits. If this occurs, reduce the frequency range of the measuring instrument or clamp onto the low-voltage side of the circuit as shown in [Figure 7](#), as appropriate.

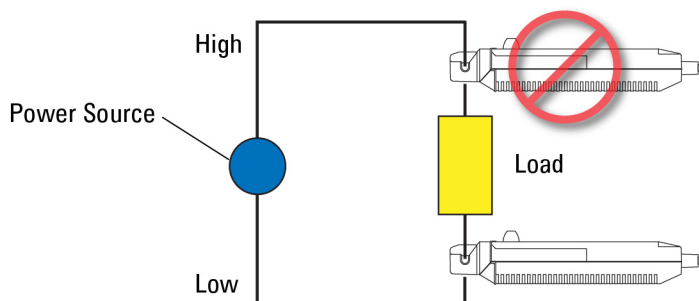

**Figure 7** Clamp Onto the Low-Voltage Side of Circuit

### NOTE

Accurate measurement may be impossible in locations subject to strong external magnetic fields, such as transformers and high-current conductors, or in locations subject to strong external electric fields, such as radio transmission equipment.

### NOTE

When performing continuous measurements, it is necessary to be aware that the zero offset voltage will drift if the ambient temperature changes.

**NOTE**

At some frequencies, some sound may be produced by resonance. This has no effect on measurements.

## Installing and Removing Bushing

Variation in the position of the conductor under test within the probe's sensor aperture can cause variation in the measurement results. To achieve measurement accuracy, the position of the conductor under test within the sensor aperture should not vary and should lie in the center of the aperture. If the diameter of your conductor under test (including the insulation around it) is less than 1.65mm, it is recommended that you use bushing on the probe's sensor aperture. This minimizes measurement variations that may be caused due to the variation in the position of the conductor under test.

Bushing (Keysight part number N7026-41201) is shipped with the N7026A probe.

**CAUTION**

Avoid touching the sensor's core surfaces while installing or removing the bushing.

### To install bushing on the sensor aperture

- 1 Push the open end of the bushing over the bottom of the probe's sensor head.

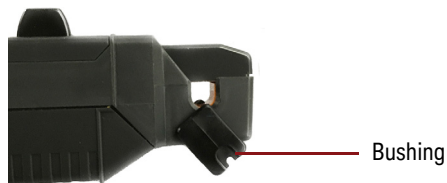

- 2 Turn around the bushing to bring it to the front of the sensor head.



- 3 Slide the probe's opening lever to open its sensor head.
- 4 Continue turning around the bushing and then gently push it down so as to place it correctly inside the sensor aperture.



A correctly installed bushing is displayed in the following picture.

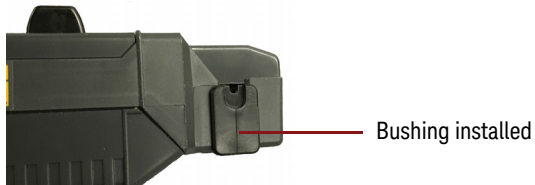

**To remove bushing from the sensor aperture**

- 1 Slide the probe's opening lever to open its sensor head.
- 2 Gently pull the bushing straight up and away from its installed position on the sensor aperture.

## Performing Demagnetization and Zero Offset

### Before you Start

#### NOTE

Allow both the oscilloscope and probe to warm up for at least 30 minutes before making these adjustments.

#### WARNING

**DO NOT press the De-Gauss button to perform demagnetization while the conductor being measured is clamped. Doing so can damage the circuitry or cause an accident.**

- 1 Set the channel offset to 0V for the oscilloscope channel to which the probe is connected.
- 2 Ensure that the probe sensor is NOT clamped around a conductor.
- 3 Slide the probe's Opening Lever forward into the **Lock** position as shown in the figure below. The UNLOCK indication on the sensor head disappears when the probe is locked properly.

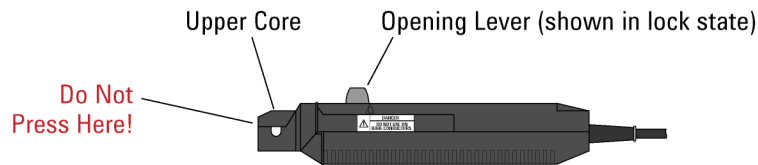

**Figure 8** Lock the sensor head

### To perform demagnetization

- 1 Press the probe's **De-Gauss** button shown in [Figure 1](#) on page 7. A demagnetization waveform will be displayed for a short time on the channel to which the probe is connected. Wait until this waveform is no longer displayed.

### To perform zero offset operation

You can use one of the following methods for the zero offset (Auto Zero routine):

- Press and hold the **De-Gauss** button on the probe for approximately three seconds. This initiates a degauss operation and then triggers the oscilloscope to perform a zero offset operation.
- Or use the Probe menu in the Infiniium / InfiniiVision software GUI to automatically initiate the demagnetization followed by the zero offset operation.

On Infiniium oscilloscopes:

- a Click **Setup** > **Probe Calibration**.
- b In the displayed dialog box, click the **AutoZero** button to automatically start the demagnetization followed by the zero offset routine. Follow the on-screen instructions.

On InfiniiVision oscilloscopes:

- a Press the scope's channel button (1, 2, 3, or 4) to which the probe is connected.
- b Click the **Probe** softkey (under the display) and then press the key to automatically start the demagnetization followed by the zero offset routine. Follow the on-screen instructions.

## Performance Verification for N7026A

Use the following procedure to test the warranted Accuracy specifications for the N7026A probe (as listed on [page 10](#)). The recommended test interval to warrant performance of this probe is once a year. However, you can also test the probe's performance as and when required using the recommended test equipment and by following the procedure documented in this chapter.

**Table 6** Required Test Equipment

Description	Minimum Requirements	Recommended Test Equipment
Oscilloscope	Bandwidth $\geq$ 250 MHz Amplitude accuracy: $\leq$ 0.4%	Infiniium or InfiniiVision with 1 M $\Omega$ input
Two Digital Multimeters	-	Keysight U1251B Handheld Digital Multimeter or equivalent DVM/DMM
AC Current Generator	AC 10 A <sub>rms</sub> , 50 or 60 Hz, sine wave Amplitude accuracy: $\leq$ 0.3%	Keysight AC6800 or Wavetek 9100
Probe Adapter	-	Keysight N1022B Probe Adapter
Power Supply	-	Keysight 1143A Probe Offset Control and Power Module
Test Cables (with banana jacks)	-	-
BNC Cable	-	-
BNC (F) to Banana Adapter	-	-
NMD 3.5mm (M) to 3.5mm (F) adapter	-	-
3.5mm (M) to BNC (F) adapter	-	-

## Procedure

- 1 Turn on the oscilloscope and then connect the N7026A probe to the oscilloscope.
- 2 Set A/div to **10mA/div**.
- 3 On an Infiniium oscilloscope, choose **Setup > Probe Configuration....** to access the **Probe Configuration** dialog box and then record the **Attenuation** scale factor. On an InfiniiVision oscilloscope, use the **Probe** softkey to record the attenuation scale factor of the probe.



The attenuation scale factor should be  $1 \pm 10\%$ . If the scale factor is beyond  $1 \pm 10\%$ , then return the probe for service. Examples of correct attenuation scale factor are shown below.

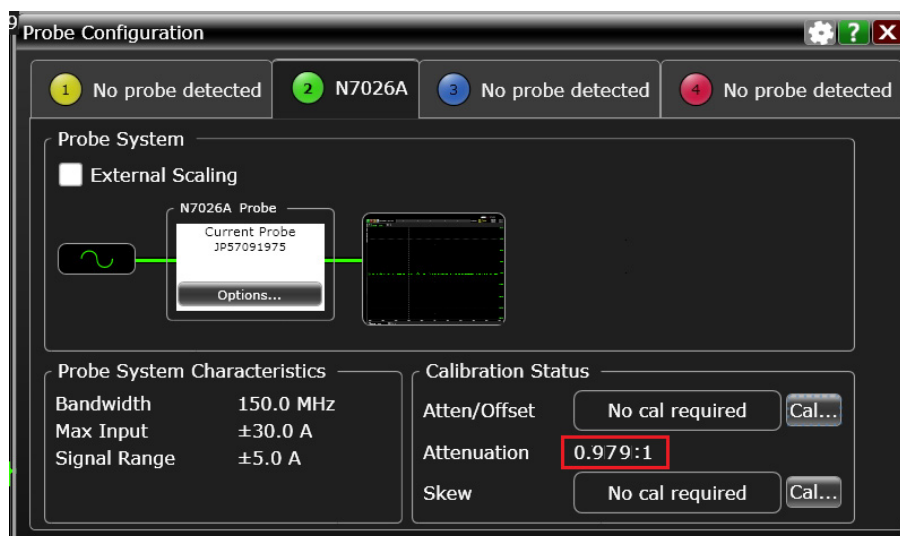
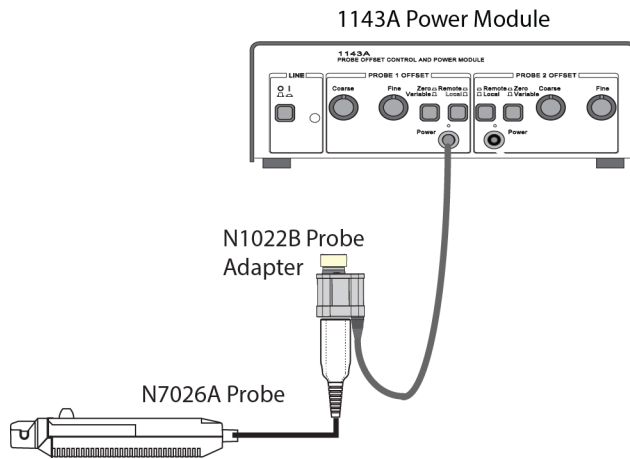

**Figure 9** Attenuation scale factor on an Infiniium oscilloscope



**Figure 10** Attenuation scale factor on an InfiniiVision oscilloscope

- 4 Remove the N7026A probe from the oscilloscope.
- 5 To provide power to the N7026A probe, connect the power cord of the N1022B probe adapter to the Power connector on the front panel of the 1143A power module. Then connect the N7026A probe's output to the N1022B probe adapter's input.



**Figure 11** Providing power to the N7026A probe

- 6 Turn on the equipment.
- 7 Wait for 20 minutes to allow the probe to warm up.
- 8 Connect the test setup as shown in [Figure 12](#) as per the following substeps.
  - a Clamp the N7026A probe around the test cable <1> and lock the sensor head of the probe.
  - b Press the **De-Gauss** button on the probe.
  - c Set the digital multimeter (DMM <1>) to  $A_{rms}$  mode.
  - d Connect the test cable <1> to the positive terminal of the AC current generator's OUTPUT terminal block and to the current input of the DMM <1>.
  - e Connect the test cable <2> to the negative terminal of the AC current generator's OUTPUT terminal block and to negative input of the DMM <1>.
  - f Using the DMM <1>, set the output current of AC current generator to  $1A_{rms}$ .

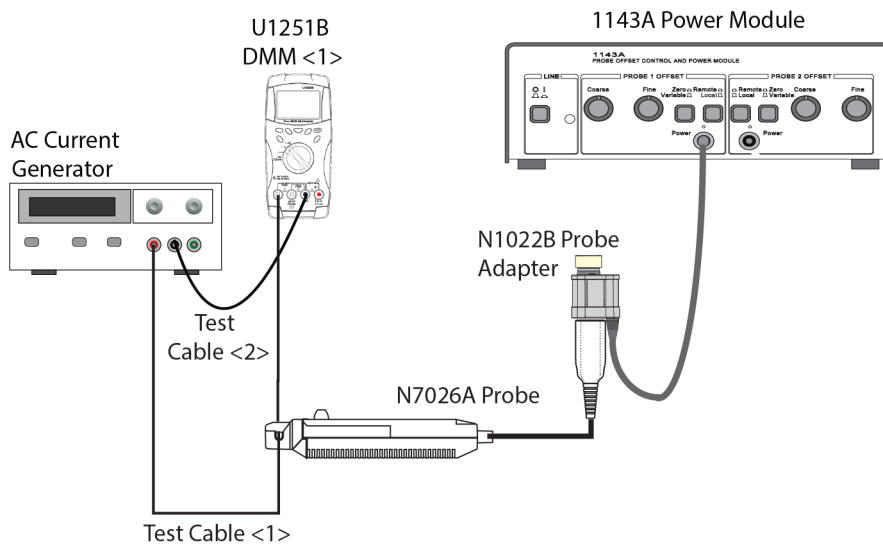

**Figure 12** Setting up AC Current Generator

- 9 Set the DMM <2> to  $V_{\text{rms}}$  mode.
- 10 As displayed in [Figure 13](#), connect a BNC cable to the:
  - a N1022B adapter's output using the NMD 3.5mm (M) to 3.5mm (F) adapter and 3.5mm (M) to BNC (F) adapter.
  - b DMM <2> using a BNC (F)-to-banana adapter.

This completes the test setup.

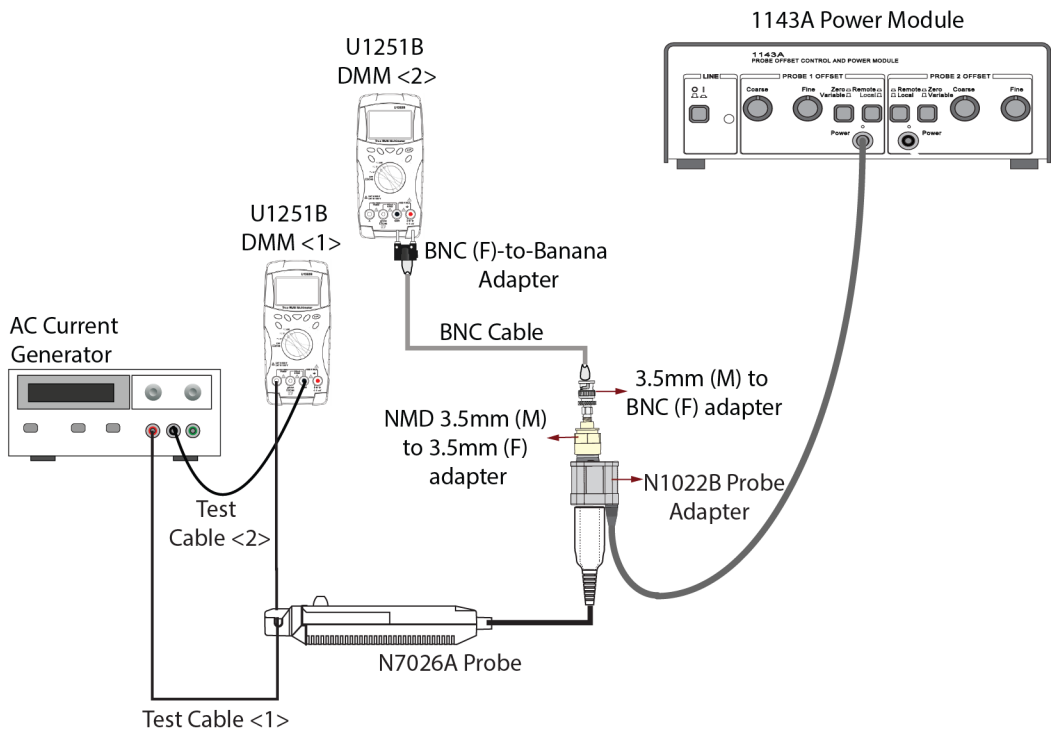

**Figure 13** Complete Test Setup

- 11 Measure the current and record  $V_{rms}$  output of the probe as displayed on the DMM <2>.
- 12 Calculate gain as follows:

$$\text{Gain} = V_{rms} * \text{scale factor}$$

Gain should be between 0.99 and 1.01 (+/-1% gain accuracy).

- 13 Remove the test cable and AC current generator from the N7026A probe.

## Plots

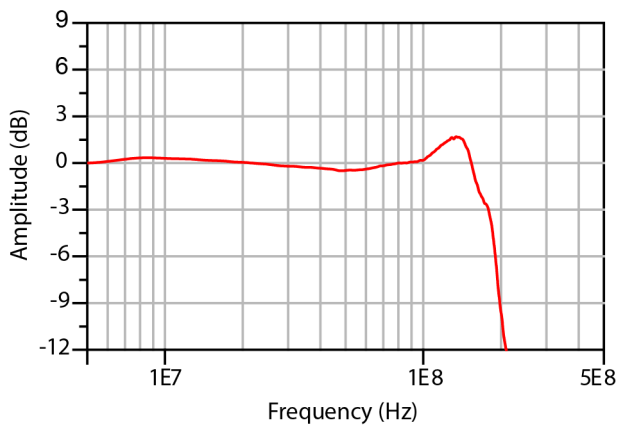

**Figure 14** Frequency Response of N7026A for 1x Attenuation Mode

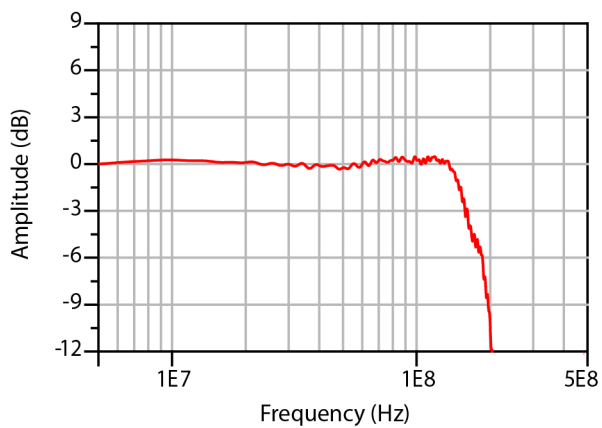

**Figure 15** Frequency Response of N7026A for 5x Attenuation Mode

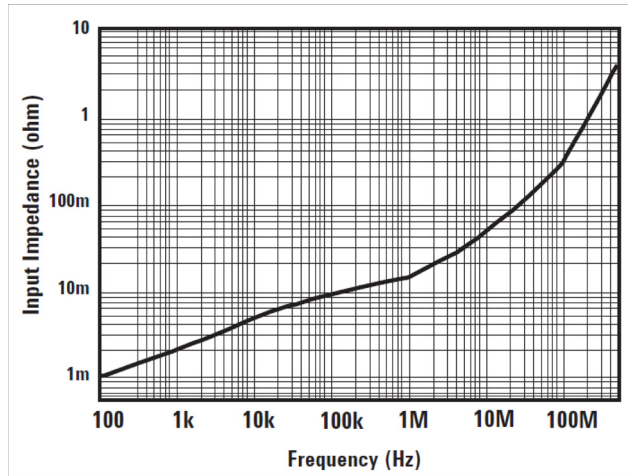

Figure 16 Insert Impedance of N7026A

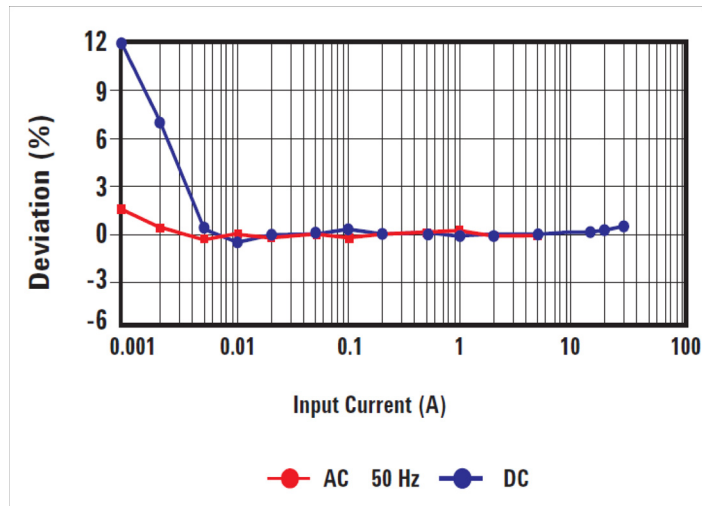









Figure 17 Amplitude Accuracy Characteristic of N7026A

Refer to "Input Current Limits for N7026A" on page 19. for the derating curve of maximum continuous input current range for N7026A.

## Product Markings and Labels

**Table 7** Instrument Markings

Marking	Description
	Indicates that only insulated conductors suited to the voltage of the circuit under test can be measured. DO NOT use with an uninsulated conductor.
	This symbol indicates the Environmental Protection Use Period (EPUP) for the product's toxic substances for the China RoHS requirements.
	The CE mark is a registered trademark of the European Community. ISM GRP 1-A denotes the instrument is an Industrial Scientific and Medical Group 1 Class A product. ICES/NMB-001 indicates product compliance with the Canadian Interference-Causing Equipment Standard.
	The product is marked with this symbol when it is necessary for the user to refer to the instructions in the documentation.
	KC certification mark to demonstrate compliance with the South Korean EMC requirements. South Korean Class A EMC declaration This equipment is Class A suitable for professional use and is for use in electromagnetic environments outside of the home.
	Indicates a risk of electric shock. Refer to the manual for more information.
	The crossed out wheeled bin symbol indicates that separate collection for waste electric and electronic equipment (WEEE) is required, as obligated by the EU DIRECTIVE and other National legislation.  Please refer to <a href="https://www.keysight.com/go/takeback">keysight.com/go/takeback</a> to understand your Trade in options with Keysight in addition to product takeback instructions.



## Service Strategy

For calibration testing, return the probe to a Keysight Service Center. If the probe is under warranty, normal warranty services apply. If the probe is not under warranty, repair costs will be applied.

### To return the Probe to Keysight Technologies for Service

Call (800) 829-4444 for further details and the location of your nearest Keysight Technologies Service Office or go to [www.keysight.com/find/assist](http://www.keysight.com/find/assist) for contact information.

- 1 Write the following information on a tag and attach it to the probe.
  - Name and address of the owner
  - Probe model number
  - Description of service required or failure indications
- 2 Retain all accessories.
- 3 Return the probe in its case or pack the probe in foam or other shock-absorbing material and place it in a strong shipping container. You can use the original shipping materials or order materials from an Keysight Technologies Sales Office. If neither are available, place 3 to 4 inches of shock-absorbing material around the instrument and place it in a box that does not allow movement during shipping.
- 4 Seal the shipping container securely.
- 5 Mark the shipping container as FRAGILE. In all correspondence, refer to the instrument by model number and full serial number.



# Index

## A

AC accuracy, 32  
accuracy, 10  
AutoProbe, 23

## B

bushing, 27, 28

## C

cable diameter, 11  
calibration, 32  
characteristics and specifications, 10  
China RoHS requirements, 40  
current direction indicator, 27

## D

DC supply voltage requirements, 11  
degauss, 30  
demag, 30  
demagnetizing switch, 8  
dimensions (sensor), 11  
dimensions output pod, 11

## H

high frequencies, 27  
high transient time signals, 5  
high-sensitivity mode, 5

## I

IEC 61010-1 Safety Standards, 15  
impedance, insertion, 10  
input current limits, 19  
insertion impedance, 10  
inspection, 13  
instrument markings, 40  
ISM1-A, 40

## L

labels, 40

## M

maximum altitude, 11  
maximum cable diameter, 11  
maximum current, 10, 19  
maximum peak current, 10, 19  
maximum rated power, 10  
maximum relative humidity, 11  
measurement procedure, 23

## N

noise, 10

## O

opening lever, 8  
opening sensor head, 25  
operating temperature range, 11  
ow-sensitivity mode, 5

## P

probe bandwidth, 10  
probe power consumption, 11  
probe sensitivity, 10

## R

risetime, 10

## S

safety warnings, 15  
sensitivity, 10  
sensor cable length, 11  
sensor head, 8  
sensor heat limit, 19  
service, 41  
storage temperature range, 11

## T

temperature coefficient, 10  
temperature range, 11

## U

use, 11  
using, 25

## V

vertical scale, 10

## W

weight, 11

## Z

zero offset, 30

Index

Distributed by:

**Sie haben Fragen oder wünschen eine Beratung?** Angebotsanfrage unter **+49 7121 / 51 50 50** oder über **info@datatec.eu**

**dataTec**