

dataTec

Mess- und Prüftechnik. Die Experten.

**Ihr Ansprechpartner /
Your Partner:**

dataTec AG
E-Mail: info@datatec.eu
>>> www.datatec.eu



Authorized
Distributor



Product Brochure

PXI Source Measure Units

Contents

[PXI 1-Channel Source Measure Units](#)

[PXI Multichannel Source Measure Units](#)

[Key Features](#)

[Software](#)

[Supporting Documentation](#)

[Configure a Custom NI System](#)

[What is PXI?](#)

[PXI Instrumentation](#)

[Hardware Services](#)

PXI 1-Channel Source Measure Units

[PXIe-4135](#), [PXIe-4136](#), [PXIe-4137](#), [PXIe-4138](#), [PXIe-4139](#), [PXIe-4190](#)



FIGURE 1

PXIe-4135, PXIe-4139, and PXIe-4137 Source Measure Units

- Software: Includes interactive soft front panel, API support for LabVIEW and text-based languages, shipping examples, and detailed help files
- Four-quadrant source and measure capability
- Up to 40 W DC and 500 W pulsed output
- SourceAdapt digital control loop technology
- Hardware timing and triggering
- High-speed sampling rate up to 1.8 MS/s
- High-speed update rate up to 100 kS/s
- Current sensitivity down to 1 fA

Built for Automated Test and Measurement

NI's source measure units (SMUs) are optimized for building automated test systems, with hardware features to reduce test execution time and tight software integration to reduce development effort. Built on the modular PXI platform, NI SMUs can be combined with other instruments such as oscilloscopes, RF generators and analyzers, and digital instruments to build mixed-signal test systems with multi-core processors and low latency communication. Additionally, the modularity and channel density of these instruments allow you to build systems that test multiple devices in parallel and improve the throughput of each tester.

NI 1-channel SMUs combine power, precision, and speed into a single instrument. The combination of power and precision allows you to use the same instrument for both high-power sweeps and low-current measurements, while the addition of a high-speed update rate and sampling rate allows you to use the instrument in non-traditional ways, such as generating and measuring a waveform. These modules also include traditional SMU features such as output disconnect relays to isolate the instrument from your circuit, remote sense to compensate for lead drop, and guard to minimize leakage current in small signals. This combination of features allows you to use NI system SMUs in a wide range of applications, from materials research and parametric test to high volume production test of RF and mixed-signal ICs.

Table 1. 1-channel SMUs provide high-power, high-precision, and high-speed source-measure capability on a single SMU channel.

| | <u>PXIe-4135</u> | | <u>PXIe-4136</u> | | <u>PXIe-4137</u> | | <u>PXIe-4138</u> | | <u>PXIe-4139</u> | | <u>PXIe-4190</u> | |
|---------------------------------------|------------------|----|------------------|----|------------------|----|------------------|----|------------------|----|------------------|--|
| Maximum Voltage (V) | 200 | | 200 | | 200 | | 60 | | 60 | | 40 | |
| Maximum DC Current (A) | 1 | | 1 | | 1 | | 3 | | 3 | | 100 mA | |
| Maximum Pulse Current (A) | 3 | | N/A | | 3 | | N/A | | 10 | | N/A | |
| Maximum DC Power (W) | 20 | 40 | 20 | 20 | 40 | 20 | 20 | 40 | 20 | 40 | 4 | |
| Maximum Pulsed Power (W) | 500 | | N/A | | 500 | | N/A | | 500 | | N/A | |
| Current Sensitivity (pA) | 0.01 | | 1 | | 0.1 | | 1 | | 0.1 | | 0.001 | |
| SourceAdapt Custom Transient Response | ● | | - | | ● | | - | | ● | | ● | |
| Programmable Output Resistance | ● | | - | | ● | | - | | ● | | - | |
| 2nd Order Noise Rejection | ● | | - | | ● | | - | | ● | | ● | |
| Connectivity | Triaxial | | Screw Terminal | | Screw Terminal | | Screw Terminal | | Screw Terminal | | BNC Triaxial | |
| High Voltage Safety Interlock | ● | | ● | | ● | | - | | - | | - | |

Detailed View of a 1-Channel SMU



FIGURE 2

Detailed view of the PXIe-4137 SMU

PXI Multichannel Source Measure Units

PXIe-4140, PXIe-4141, PXIe-4142, PXIe-4143, PXIe-4144, PXIe-4145, PXIe-4147, PXIe-4162, and PXIe-4163



FIGURE 3

PXIe-4163, PXIe-4143, and PXIe-4145 SMUs

- Software: Includes interactive soft front panel, API support for LabVIEW and text-based languages, shipping examples, and detailed help files
- Four-quadrant source and measure capability
- Up to 408 channels in a 4U, 19-inch PXI chassis
- Hardware timing and triggering
- High-speed sampling rate up to 1.8 MS/s
- High-speed update rate up to 100 kS/s
- SourceAdapt digital control loop technology

Built for Automated Test and Measurement

NI multichannel SMUs are optimized for building parallel, high-channel count test systems for applications such as multi-site semiconductor test and wafer-level reliability. With up to 408 SMU channels in a single PXI chassis, and the ability to expand to two or more PXI chassis, you can add hundreds of SMU channels to stand-alone PXI systems or within the NI Semiconductor Test System (STS). To learn more about STS, visit www.ni.com/sts.

Table 2. The NI multichannel SMU family provides industry-leading channel density with up to 408 channels in a single 4U, 19-inch PXI chassis.

| | <u>PXIe-4140</u> | <u>PXIe-4141</u> | <u>PXIe-4142</u> | <u>PXIe-4143</u> | <u>PXIe-4144</u> | <u>PXIe-4145</u> | <u>PXIe-4147</u> | <u>PXIe-4162</u> | <u>PXIe-4163</u> | | |
|--------------------------------|------------------|------------------|------------------|------------------|------------------|------------------|------------------|------------------|-------------------|----|-----|
| Channels | 4 | 4 | 4 | 4 | 4 | 4 | 4 | 12 | 24 | | |
| Maximum Voltage (V) | 10 | 10 | 24 | 24 | 6 | 6 | 8 | 24 | 24 | | |
| Maximum DC Current (A) | 0.1 | 0.1 | 0.15 | 0.15 | 0.5 | 0.5 | 3 | 0.1 ¹ | 0.05 ¹ | | |
| Current Sensitivity (pA) | 10 | 100 | 10 | 100 | 150 | 15 | 0.1 | 10 | 100 | 10 | 100 |
| Custom Transient Response | - | ● | - | ● | - | ● | ● | ● | ● | ● | ● |
| Programmable Output Resistance | - | ● | - | ● | - | ● | ● | - | - | - | - |
| 2nd Order Noise Rejection | - | ● | - | ● | - | ● | ● | ● | ● | ● | ● |
| Connectivity | DSUB | | | | | | | | | | |

¹NI recommends the PXIe-1095 for use with the PXIe-4162, PXIe-4147, PXIe-4163 SMUs to achieve full current output per channel. See the device specifications for more details on power and current limits.

Detailed View of a Multichannel SMU



FIGURE 4
Detailed view of the PXIe-4163 SMU

Key Features

Channel Density and Scalability

SMU channel density is increasingly important for multi-site testing and for improving test throughput in applications like reliability that require inherently long stress and measurement cycles. The modularity of the PXI platform allows you to optimize the size of your test system and number of parallel SMU channels by choosing the appropriate chassis and instruments. In a single PXI chassis, you can add up to 17 1-channel SMUs or up to 408 parallel SMU channels using multichannel SMUs. You can also mix with switches or combine with other combine with other types of instruments to build tightly integrated mixed-signal test systems. For even larger systems, you can mount multiple chassis in an automated test rack and combine them together with chassis expansion cards.



FIGURE 5
You can add up to 17 1-channel SMUs in a single 4U, 19-inch PXI chassis such as the PXIe-1095.

Hardware-Timed Sequencing and Triggering

NI SMUs have a hardware-timed, deterministic sequencing engine that allows the instrument to execute commands and acquire data without any intervention from the host software. This eliminates the software overhead and jitter associated with software-controlled sequences and reduces the execution time of your overall test. Within these hardware-timed sequences, you can modify over 30 properties such as aperture time, current range, voltage range, DC output mode, and source delay, to optimize each step within your sequence. Additionally, the timing engine gives you the flexibility to repeat a sequence for a finite number of steps, or continuously source and measure for an infinite amount of time.

Each SMU has numerous triggers and events such as source trigger, measure trigger, and measure complete, that you can share via the backplane of the PXI chassis to communicate between different instruments. This allows you to synchronize the start of multiple SMUs, create nested sweeps, or send/receive commands from other instruments like oscilloscopes and RF analyzers.

High-Speed Measurement and Update Rate

NI SMUs can sample up to 1.8 MS/s and source up to 100 kS/s, which adds new functionality to a traditionally DC instrument. The high-speed sampling rate allows you to use the SMU as a high voltage or current digitizer to capture transient behavior or monitor current consumption over time. The fast update rate allows you to step through large sequences very quickly or use the SMU to generate arbitrary waveforms at low frequencies. Since NI SMUs communicate and share data via a high bandwidth, low latency PCI Express interface, you can use the full update and sampling rate of the instrument to stream data to and from the host PC. This functionality is transparent to the user and does not require you to configure a buffer, allocate memory, or pause your acquisition and wait for data to transfer from the instrument to the host.

High-Precision, High-Accuracy Measurements

NI SMUs are built with a combination of off-the-shelf high-speed ADC technology and a custom-designed sigma-delta converter to provide low noise measurements across a wide range of measurement speeds. This design results in a high dynamic measurement range that allows you to measure small changes in a signal without constantly changing ranges. It also allows you to optimize your measurement cycle based on your test requirements, so you can adjust the instrument's aperture time based on the acceptable level of noise for a test. NI SMUs include a built-in self-calibration feature that corrects for time and temperature drift by recalculating certain internal reference values, gains, and offsets. This method significantly improves accuracy over the full operating temperature range of the device by reducing sources of error such as gain and offset error for voltage and current. For high accuracy devices with +/- 1 deg C specifications, the self-calibration routine helps ensure your device is operating within 1 degree of its calibrated temperature and that you can apply the tighter accuracy specifications. The self-calibration routine takes less than 10 seconds to complete and can be called programmatically from your application software.

SourceAdapt Digital Control Loop Technology

SourceAdapt is a digital control loop technology that gives you the ability to optimize the SMU response for any device under test (DUT). This provides fast and stable measurements for a variety of loads, even highly capacitive or inductive loads, and prevents damage to your DUT by removing harmful overshoots and oscillations. By allowing complete customization of the SMU response, this technology allows you to remove unwanted characteristics of the instrument while still maintaining a fast settling time – all without adding any custom circuitry between the instrument and the load. Because this capability is handled programmatically, you can quickly reconfigure your SMU for high speed or high stability testing and maximize the usage of your instrument.

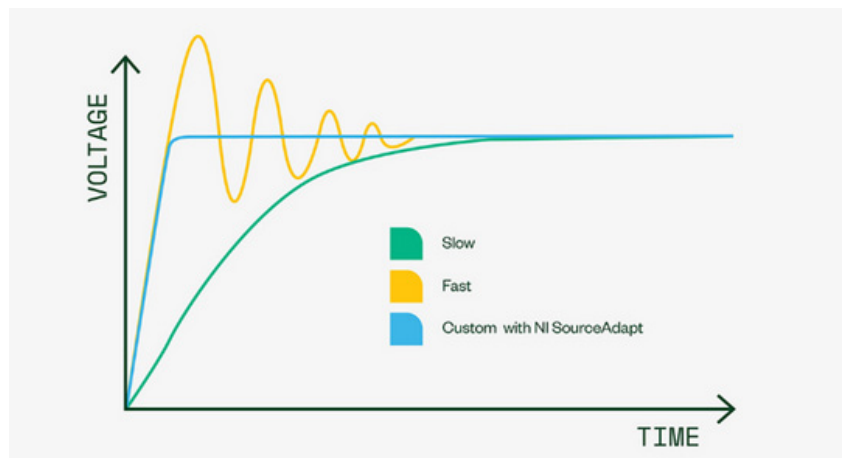

FIGURE 6

SourceAdapt gives you the ability to optimize the SMU response for any DUT.

Extended Range Pulsing

Select NI 1-channel SMUs can exceed their 20 W DC power boundary and generate pulses up to 500 W. Generating short, high-power pulses allows you to test devices such as high-brightness LEDs and power transistors while minimizing heat dissipation in the DUT. Having a single device capable of sourcing or sinking up to 500 W reduces the need for stacking multiple SMUs in parallel, and generating short, accurate pulses reduces the need for thermal management systems.

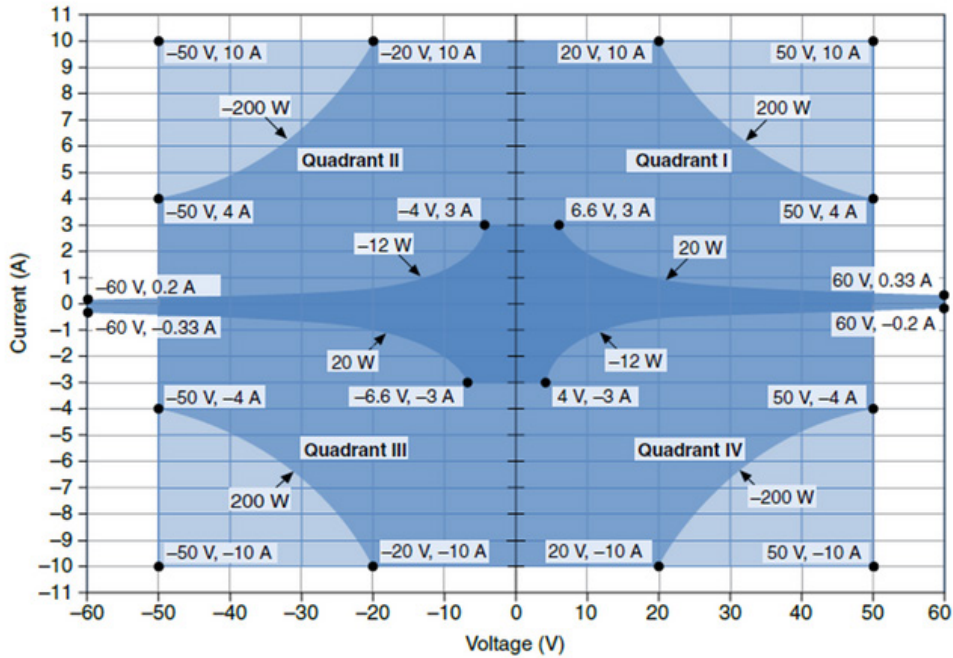

FIGURE 7 The PXIe-4139 can generate pulses up to 10 A with lengths between 50 μ s and 1 ms.

Software

In addition to the soft front panel, the NI-DCPower driver includes a best-in-class API that works with a variety of development options such as LabVIEW, C/C++, C#, and others. To ensure long-term interoperability of SMUs and power supplies, the NI-DCPower driver API is the same API used for all past and current NI SMUs and power supplies. The driver also provides access to help files, documentation, and dozens of ready-to-run shipping examples you can use as a starting point for your application.

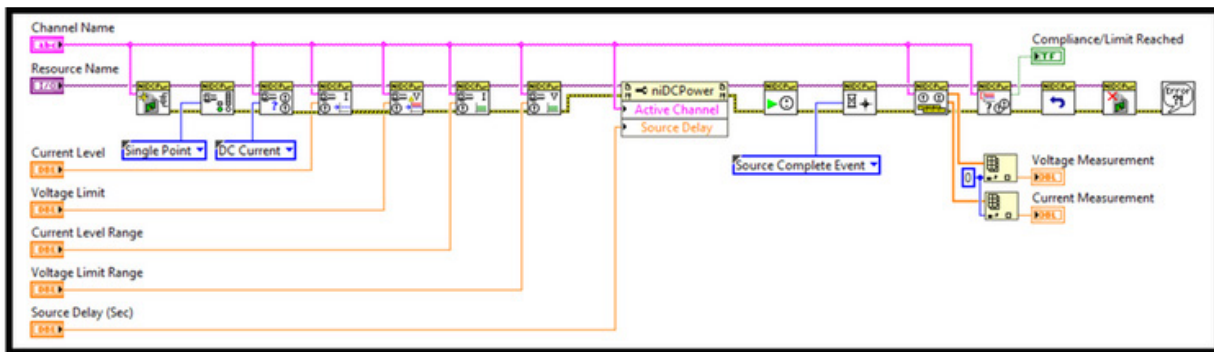
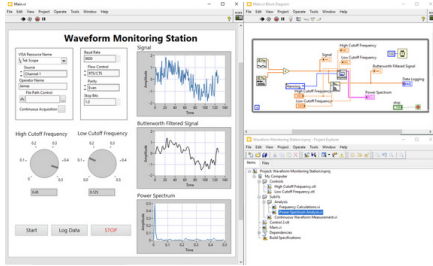

FIGURE 8 LabVIEW VI using the DC-Power API

NI Software- The Right Tool for the Job

NI has a variety of software for engineers working on research, validation, and production test applications. Learn about our software that helps engineers perform quick ad-hoc tests, build an automated test system, automate data analysis and reporting, develop test sequences, and more.

LabVIEW



Graphical programming environment that engineers use to develop automated research, validation, and production test systems.

- Acquire data from NI and third-party hardware and communicate using industry protocols
- Use configurable, interactive display elements
- Take advantage of available analysis functions

DIAdem

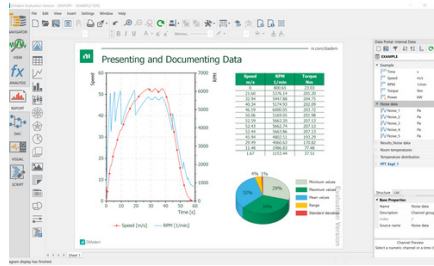

Data analytics software for measurement data search, inspection, analysis, and automated reporting.

- Display data in multiple 2D-axis systems
- Perform calculations with a simple point-and-click interface
- Automate your measurement data analysis workflow, from import to analysis

TestStand

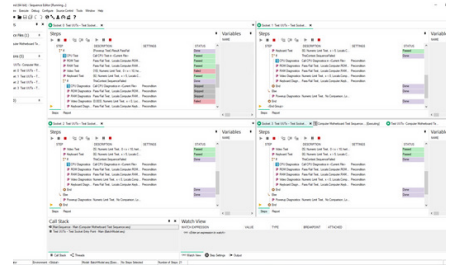

Test executive software that accelerates system development for engineers in validation and production.

- Call and execute tests in LabVIEW, Python, C/C++, or .NET
- Conduct complex tasks, such as parallel testing
- Create customer operator interfaces and robust tools for deployment and debugging

G Web

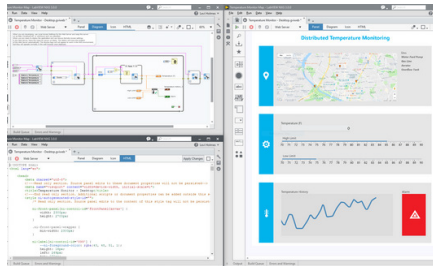

Development software that helps engineers create web-based user interfaces without the need for traditional web development skills.

- Data transfer APIs for connecting to systems written in LabVIEW, Python, or C#
- Pre-built objects for data display and user input
- Included hosting on SystemLink™ Cloud

FlexLogger™

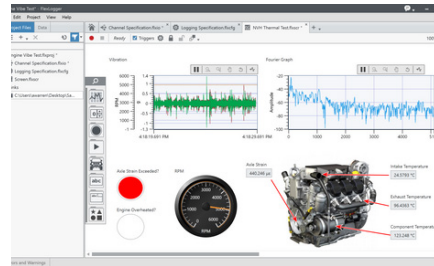

No-code data acquisition software engineers use to build validation and verification test applications.

- Interactive visualization tools for monitoring tests with drag-and-drop charts, graphs, and controls
- Ability to set alarms that monitor single channels or groups for unexpected behavior

InstrumentStudio™

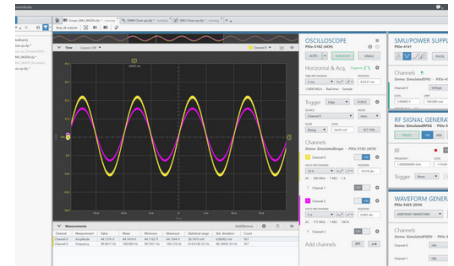

Application software that simplifies setup and configuration of NI PXI hardware

- Customizable layouts for monitoring multiple instruments at once
- Interactively debug in tandem with code
- TDMS file export containing instrument settings, measurements, and raw data

Supporting Documentation

Table 3. PXI SMU Documentation

| Document Type | 1-Channel SMU Models | Multichannel SMU Models |
|-----------------------|--|---|
| Getting Started Guide | PXIe-4135 , PXIe-4136 , PXIe-4137 , PXIe-4138 , PXIe-4139 , PXIe-4190 | PXIe-4140 , PXIe-4141 , PXIe-4142 , PXIe-4143 , PXIe-4144 , PXIe-4145 , PXIe-4147 , PXIe-4162 , PXIe-4163 |
| Specifications | PXIe-4135 , PXIe-4136 , PXIe-4137 , PXIe-4138 , PXIe-4139 , PXIe-4190 | PXIe-4140 , PXIe-4141 , PXIe-4142 , PXIe-4143 , PXIe-4144 , PXIe-4145 , PXIe-4147 , PXIe-4162 , PXIe-4163 |

Configure a Custom NI System

NI's online system advisors help you create a custom system based on your specific requirements. Use the advisor to choose compatible hardware, software, accessories, and services and then save your selections as configurations for easy quoting and purchasing later. Visit ni.com/advisor to learn more.

What Is PXI?



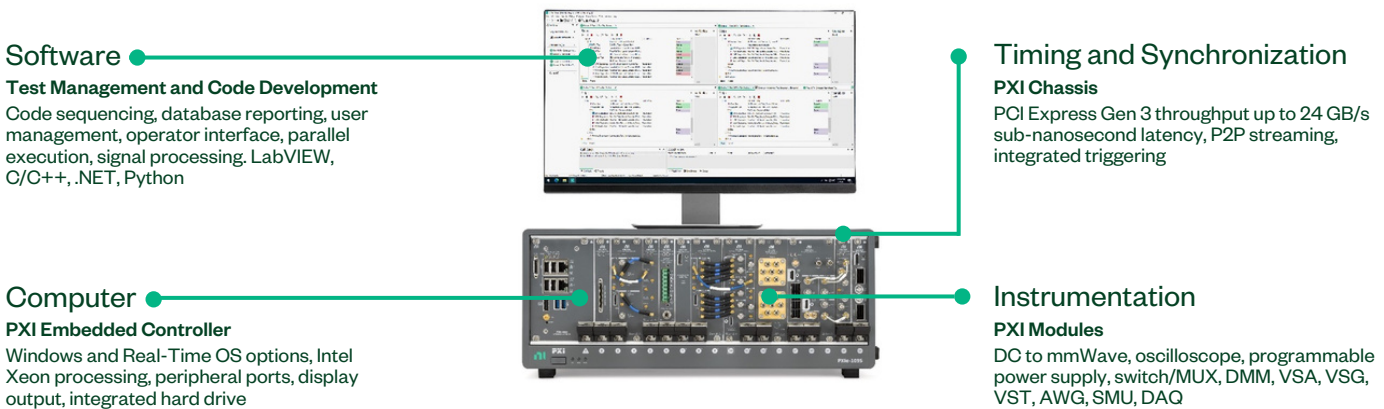

A Platform Approach to Test and Measurement

Powered by software, PXI is a rugged PC-based platform for measurement and automation systems. PXI combines PCI electrical-bus features with the modular, Eurocard packaging of CompactPCI and then adds specialized synchronization buses and key software features. PXI is both a high-performance and low-cost deployment platform for applications such as manufacturing test, military and aerospace, machine monitoring, automotive, and industrial test. Developed in 1997 and launched in 1998, PXI is an open industry standard governed by the PXI Systems Alliance (PXISA), a group of more than 70 companies chartered to promote the PXI standard, ensure interoperability, and maintain the PXI specification.



Integrated with the Latest Commercial Technology

By leveraging the latest commercial technology for our products, we can continually deliver high performance and high-quality products to our users at a competitive price. The latest PCI Express Gen 3 switches deliver higher data throughput, the latest Intel multicore processors facilitate faster and more efficient parallel (multisite) testing, the latest FPGAs from Xilinx help to push signal processing algorithms to the edge to accelerate measurements, and the latest data converters from TI and ADI continually increase the measurement range and performance of our instrumentation.

| | | | |
|--|--|---|---|
| HIGHER DATA THROUGHPUT  PCI Express Gen 3 | PARALLEL TEST EXECUTION  Multicore Processors | MEASUREMENT ACCELERATION  FPGAs | INCREASED MEASUREMENT RANGE  Data Converters |
|--|--|---|---|

PXI Instrumentation

NI offers more than 600 different PXI modules ranging from DC to mmWave. Because PXI is an open industry standard, nearly 1,500 products are available from more than 70 different instrument vendors. With standard processing and control functions designated to a controller, PXI instruments need to contain only the actual instrumentation circuitry, which provides effective performance in a small footprint. Combined with a chassis and controller, PXI systems feature high-throughput data movement using PCI Express bus interfaces and sub-nanosecond synchronization with integrated timing and triggering.



Oscilloscopes

Sample at speeds up to 12.5 GS/s with 5 GHz of analog bandwidth, featuring numerous triggering modes and deep onboard memory



Digital Multimeters

Perform voltage (up to 1000 V), current (up to 3A), resistance, inductance, capacitance, and frequency/period measurements, as well as diode tests



Digital Instruments

Perform characterization and production test of semiconductor devices with timing sets and per channel pin parametric measurement unit (PPMU)

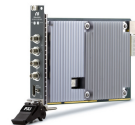

Waveform Generators

Generate standard functions including sine, square, triangle, and ramp as well as user-defined, arbitrary waveforms



Frequency Counters

Perform counter timer tasks such as event counting and encoder position, period, pulse, and frequency measurements



Source Measure Units

Combine high-precision source and measure capability with high channel density, deterministic hardware sequencing, and SourceAdapt transient optimization



Power Supplies & Loads

Supply programmable DC power, with some modules including isolated channels, output disconnect functionality, and remote sense



FlexRIO Custom Instruments & Processing

Provide high-performance I/O and powerful FPGAs for applications that require more than standard instruments can offer



Switches (Matrix & MUX)

Feature a variety of relay types and row/column configurations to simplify wiring in automated test systems



Vector Signal Transceivers

Combine a vector signal generator and vector signal analyzer with FPGA-based, real-time signal processing and control



GPIB, Serial, & Ethernet

Integrate non-PXI instruments into a PXI system through various instrument control interfaces



Data Acquisition Modules

Provide a mix of analog I/O, digital I/O, counter/timer, and trigger functionality for measuring electrical or physical phenomena

NI Hardware Services

All NI hardware includes a one-year warranty for basic repair coverage and calibration in adherence to NI specifications prior to shipment. PXI systems also include basic assembly and a functional test. NI offers additional entitlements to improve uptime and lower maintenance costs with service programs for hardware.

| | Hardware | Standard | Premium | Description |
|---|-------------------------------|-------------------|------------------------|--|
| Duration at Point of Sale | 1 year; included | 3 years; optional | 3 years; optional | NI enhances warranty coverage with additional service benefits provided with a hardware service program. |
| Maximum Duration with Renewal | ≤3 years with service program | ≤3 years | ≤3 years | NI maintains the high performance and availability of your hardware for up to three years with a hardware service program. |
| Extended Repair Coverage | • | • | • | NI restores your device's functionality and includes firmware updates and factory calibration; < 10 working days ⁴ + standard shipping. |
| System Configuration, Assembly, and Test ¹ | | • | • | NI technicians assemble, install software in, and test your system per your custom configuration prior to shipment. |
| Advanced Replacement ² | | | • | NI stocks replacement hardware that can be shipped immediately if a repair is needed. |
| System Return Material Authorization (RMA) ¹ | | | • | NI accepts the delivery of fully assembled systems when performing repair services. |
| Technical Support | • | • | • | NI provides access to support resources for your hardware. |
| Calibration Plan (Optional) | | Standard | Expedited ³ | NI performs the requested level of calibration at the specified calibration interval for the duration of the service program. |

¹ This option is only available for PXI, CompactRIO, and CompactDAQ systems.

² This option is not available for all products in all countries. Contact your local NI sales engineer to confirm availability.

³ Expedited calibration is only available for the Traceable calibration level.

⁴ This applies to non-RF products only. Standard extended repair coverage for RF products is <15 working days + standard shipping.

PremiumPlus Service Program

NI can customize the offerings listed above or offer additional entitlements such as on-site calibration, custom sparring, and lifecycle services through a [PremiumPlus Service Program](#). Contact your NI sales representative to learn more.

Technical Support

NI hardware service programs and warranty include access to technical support provided by NI support agents during local business hours. Service requests can be managed online. Additionally, take advantage of NI's award-winning [online resources](#) and [communities](#).

©2023 National Instruments. All rights reserved. National Instruments, NI, and ni.com are trademarks of National Instruments. Other product and company names listed are trademarks or trade names of their respective companies. All rights reserved. National Instruments, NI, and ni.com are trademarks of National Instruments.



Mess- und Prüftechnik. Die Experten.

Ihr Ansprechpartner /
Your Partner:

dataTec AG

E-Mail: info@datatec.eu

>>> www.datatec.eu

