



MODEL 17020

Key Features

- Regenerative battery energy discharge, efficiency 85%
 - Energy saving
 - Environment protection
 - Low heat generate
- Channels paralleled for higher currents
- Charge/discharge modes (CC, CV, CP)
 - Power Range: 600W, 1.25KW, 2.5KW, 5KW, 10KW, 20kW, 30kW, 50kW, 60KW per channel
 - Voltage Range: 20V, 60V, 100V, 200V, 500V per channel
 - Current Range: up to 2600A (parallel)
- Driving cycle simulation
- High precision measurement
- Fast current conversion
- Smooth current without over shoot
- Test data analysis function
- Data recovery protection (after power failure)
- Independent protection of multi-channel
- BMS data recording
- Thermal chamber control integration

Applications

- EV battery module
- Electric scooter
- Electric bike
- UPS
- Energy storage battery
- Power tools
- Car battery
- Lead-acid battery

REGENERATIVE BATTERY PACK TEST SYSTEM MODEL 17020

Chroma's 17020 is a high precision system specifically designed for secondary battery module and pack tests. Highly accurate sources and measurements ensure that the test quality is suitable for performing repetitive and reliable tests crucial for battery modules/packs, incoming, and outgoing inspections as well as capacity, performance, production, and qualification testing.

The system architecture of the Chroma 17020 offers regenerative discharge capabilities designed to recycle the electric energy sourced by the battery module either back to the channels in the system performing a charging function or to the utility mains in the most energy efficient manner. This feature saves electricity, reduces the facilities thermal foot print, and provides a green solution.

The Chroma 17020 system is equipped with multiple independent channels to support dedicated charge/discharge tests on multiple battery modules/packs, each with discrete test characteristics. Channels can easily be paralleled to support higher current requirements. This feature provides the ultimate in flexibility between high channel count and high current testing.

The Chroma 17020 advanced hardware design creates seamless transitions between maximum charge and maximum discharge (or

maximum discharge and maximum charge) with a rapid 50 ms conversion. This feature allows for charge/discharge modes that simulate real world scenarios.

The Chroma 17020 system has flexible programming functions and may be operated with Chroma's powerful "Battery Pro" software. With the Battery Pro software, cycling tests from basic charge or discharge to complex drive cycle testing can be created and utilized for each channel or channel groups. A thermal chamber control can be integrated into a profile and triggered by time or test results yielding a dynamic profile. Battery Pro's features allow quick and intuitive test development, eliminating the need of tedious scripting or programming by a software engineer.

The Chroma 17020 system has multiple safety features including Battery Polarity Check, Over Voltage Protection, Over Current Protection Check and Over Temperature Protection to ensure protected charge/discharge testing. In the unlikely event of power or computer communication loss, data is securely stored in system non-volatile memory protecting against potential data loss and allowing for continuous flow after restart.



SYSTEM FUNCTIONS

Independent Channels

- Independent channel operation
- Independent testing data
- Independent protection
- Independent testing process

Operating Mode

- Constant current (CC), voltage (CV), power (CP), and voltage-limit current (CC-CV) mode
- Waveform current mode
- DCIR mode
- Rest

Cut-off Conditions

- Time (s), Capacity (Ah), Voltage (V), Current (A), Temperature (°C)
- Channel data in data logger (Option)

Protection Conditions

- Over voltage(V), over current(A), over temperature(°C), and over capacity (Ah) protections
- Under voltage protection (V)
- Wire loss protection (ΔV)
- $-\Delta V / +\Delta V$ (V), $+\Delta I / -\Delta I$ (A) protections
- Delta Protection: Protect internal short of battery cell
- Channel data in data logger (option)

Testing Data Records

- Detail report : STEP / TEST TIME / TEST TIME ID / Cycle / Loop / STEP MODE / STEP TIME / VOLTAGE(V) / CURRENT(A) / CAPACITY (Ah) / Energy(Wh) / TEMPERATURE (°C) / Data Logger Channel (optional)
- STEP / STEP NO / LOOP / CYCLE / STATUS / STEP START TIME / STEP MODE / CUT OFF VOLTAGE(V) / CUT OFF CURRENT(A) / CUT OFF CAPACITY(Ah) / DCIR(mOhm) / Energy(Wh) / TEMPERATURE (°C) / Data Logger Channel (optional)

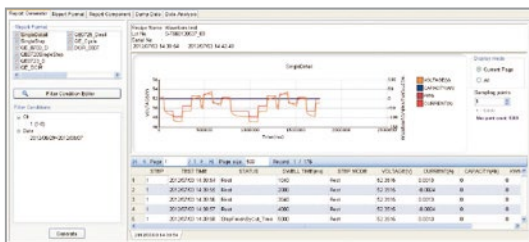

Compact Size

The dimensions of a regenerative system are smaller when compared to a system that has to dissipate energy.

Continuous Transition

- Continuous charge and discharge transition: No time delay to transit from charge to discharge. The user can verify the battery pack for a design limit.
- Continuous CC-CV transition: No overshoot current or voltage to damage the battery when transiting CC-CV

Response Time

- 50ms trip time between maximum charge and discharge current
- Smooth current without overshoot to avoid damaging the battery

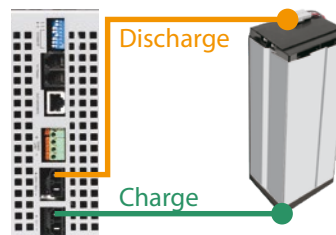
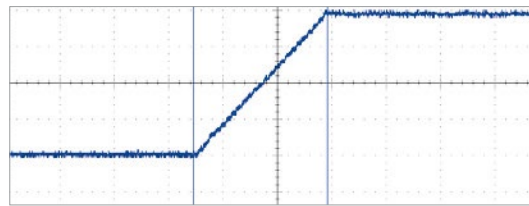

Test for battery pack with split connections

For some battery pack designs, the charge and discharge ports are split into two connectors. The user can set the 17020 software to select charge/discharge using either a single connector or two connectors separately.

Data Recovery

- 60 min of temporary data storage when sampling time is 1 sec.
- Save the test settings to resume after power failure is recovered

DRIVING CYCLE SIMULATION

The battery pack is always used under quick and un-regular current condition. The system simulates real conditions on battery pack via working condition simulator.

- Import dynamic charge/discharge power or current waveforms to simulate the DRIVE CYCLE or actual application
- Support Excel (xls) format
- 720,000 points of driving profile memory to save the waveform profile in each channel
- Minimum Δt : 10ms

High Accuracy Capacity Calculation

Voltage/current sampling rate of 50kHz used for calculating capacity ratings in dynamic waveform mode

- V/I sampling rate : 50KHz (per 20 μ s)
- Integrate calculus: I for capacity; VxI for energy

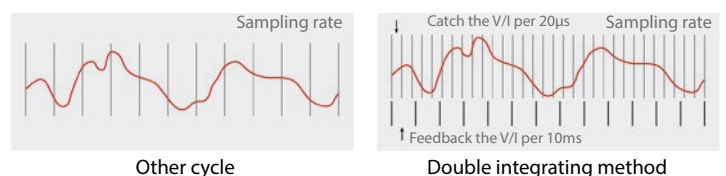
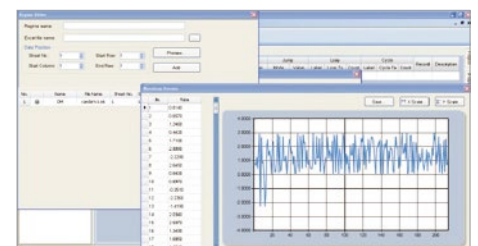

REGENERATIVE ENERGY

- Regenerative battery energy discharge
 - Direct recycle back to the battery under charging
 - Regenerate to grid
- Low heat output
- Reduce air-conditioner power consumption
- The THD of 17020 system is under 5% at rated power
- The PF is over 0.9 at rated power
- Return to factory directly

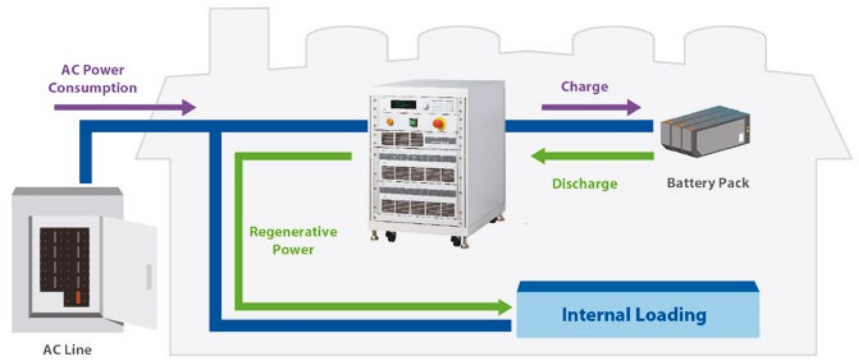

TEST ITEMS

- Drive cycle simulator
- Learning test for manufactory
- Life cycle test
- Balance control test
- DCIR test
- Capacity test
- Performance test
- Reliability test
- Over charge/discharge test
- Thermal test

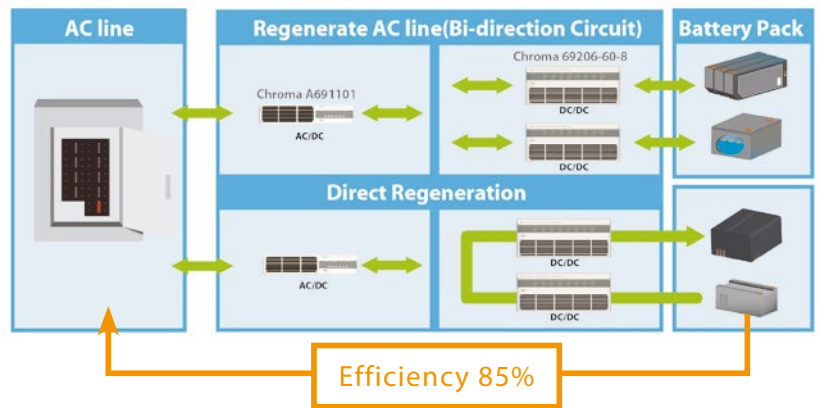

PARALLEL CONTROL - UP TO 60 CHANNELS

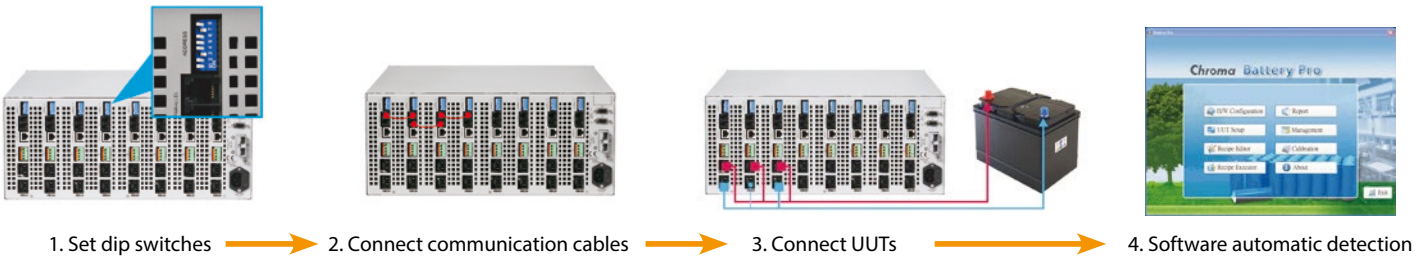

Supports Various Capacity Batteries in Parallel

Battery companies have various capacity configurations. Some customers may purchase a high power system to test all capacity battery packs. The downside is that the measurement accuracy is not sufficient for small-capacity battery packs. Using Chroma's system, customers can test under individual or parallel channels for higher capacity battery packs. The system supports different capacity batteries from a base system configuration.



GRAPHIC USER INTERFACE - BATTERY PRO

The 17020 test system is specifically designed to meet the diversified requirements for testing secondary battery packs with high safety and stability. Charge and discharge protection will abort tests when abnormal conditions are detected. Data loss, storage and recovery are protected against power failure.

- Real-time multi channel battery pack status browse
- Icon Manager: Test status of each channel is managed through different icons, easy to read and understand
- Authority management: It sets the user's authority for operation
- Fault record tracking: It records the abnormal state of each channel independently



Battery Pro main panel

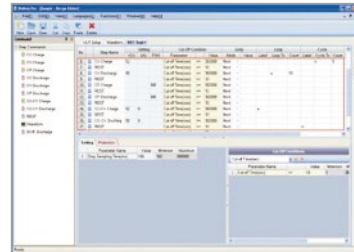

Charge/Discharge test program editor

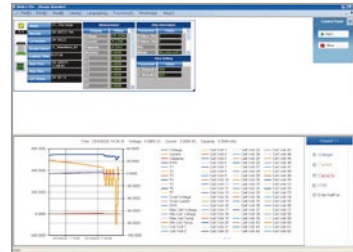

Real time monitoring

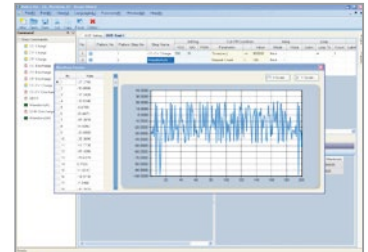

Waveform current test editor

Recipe Editor

- 255 charge/discharge conditions
- Sets dual layer loops (cycle & loop) with 9999 loops per layer
- Able to edit dynamic charge/discharge waveform with 10ms current switching speed
- Testing Step: CV / CC / CP / CC-CV / Waveform current / DCIR)
- Cut-off conditions (time, current, capacity, cut-off voltage, cut-off current, etc.)
- Next Step: Next / End / Jump / Rest

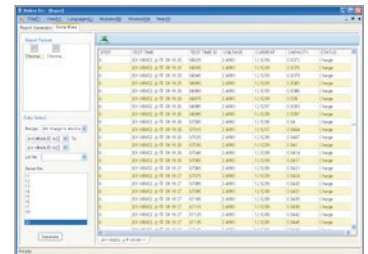
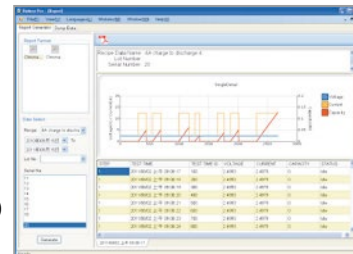

Statistical Reports

- Generate detailed report and step report
- Customized report format
- Exports test reports in PDF, CSV and XLS
- Graphical report function
- Report analysis Function: Users can create customized reports such as life-cycle report, Q (AH)-V(V) report, V(V)/I(A)/T(°C)-time report and etc. through the user-defined X and Y axis parameters.
- Real-time browsing test reports of each channel
- Diversified reports & charts: Real-time report, Cut-off report, X-Y scatter chart report

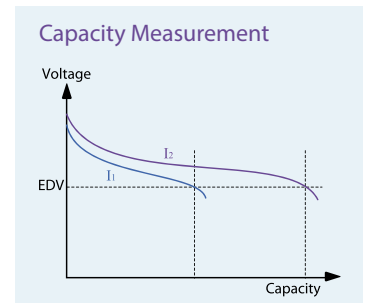
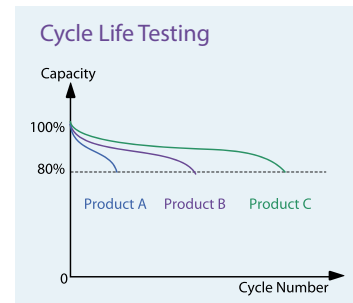

Software Integration

- Thermal chamber: Synchronize temperature control with charge/discharge profile
- Data logger: Temperature or voltage data record that can be used for setting Cut-off and protection conditions

- BMS data record : Software setting to read data from BMS by data communication unit A692000/A692001. This supports Smbus and CAN bus. The data can be set in the conditions for cut-off or protection during testing

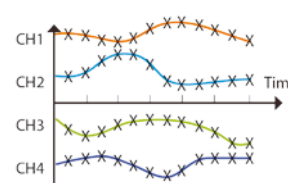
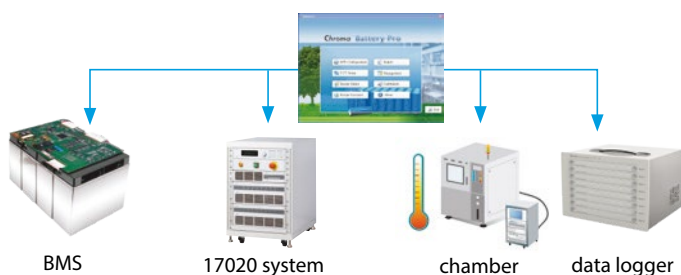

Multifunctional data logger provides synchronized sampling with constant data acquisition rate.

Minimum : 200 ms
Interface : Ethernet

SYSTEM CONFIGURATION

1. Battery charge/discharge controller
Model 69200-1
2. AC/DC Bi-directional converter
Model A691101
3. Regenerative charge/discharge Tester
Model 69200 Series
4. Thermal/Multi-function Data Logger
Model 51101-64 (option)
5. BMS Communication Unit
Model A692000/A692001

* Support other equipment upon requests

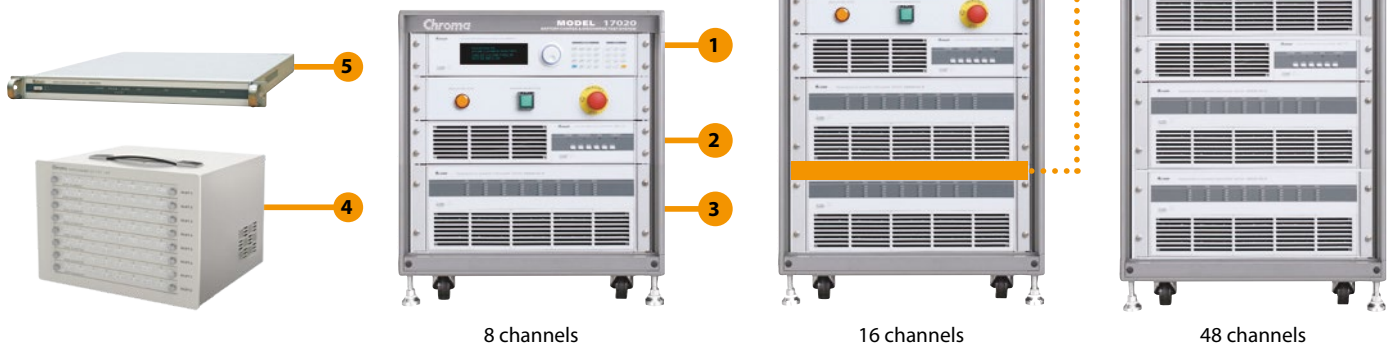
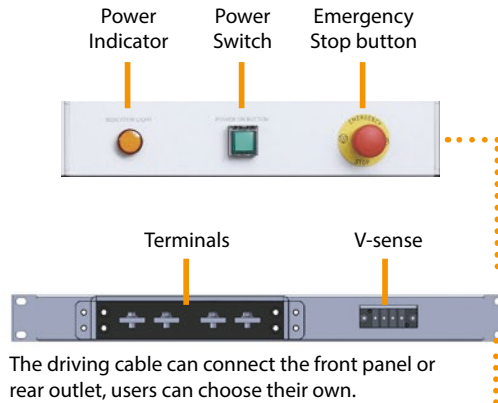

PANEL DESCRIPTION - REGENERATIVE CHARGE/DISCHARGE TESTER

Model 69206-60-8

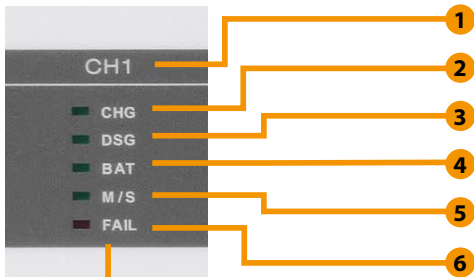

- | | |
|-------------------------------|--|
| 1. Channel No | 10. Temperature Meas. Terminal |
| 2. Charge Status Indicator | 11. Voltage Meas. Terminal |
| 3. Discharge Status Indicator | 12. Charge/ Discharge Output/
Input Connector |
| 4. UUT Connection Indicator | 13. Charge Output Connector |
| 5. Parallel Indicator | 14. Controller Connector |
| 6. Failure Indicator | 15. DC BUS Terminal |
| 7. Power Switch | 16. AC Input |
| 8. Channel DIP Switch | |
| 9. Parallel Connector | |



Front panel

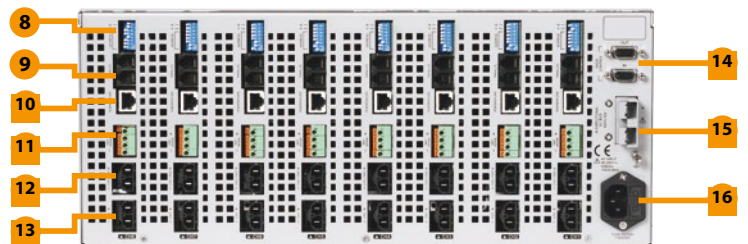

Rear panel

BATTERY SIMULATION FUNCTION

The Chroma 17020, equipped with Battery Charging/Discharging Tester and Battery Simulators, can test the battery pack and battery pack connection related products. When a product is still under development and the supplier's battery is not ready, the 17020 can simulate the battery to verify whether or not the system is functioning normally. In addition, the 17020 can control the SOC status of different batteries. Users can download different battery curves to the 17020 to test the DUT for charging and discharging status. The 17020 can also perform battery and DUT collocation evaluation tests in advance that can apply to the motor driver of vehicle start-stop systems, light EV electric controllers, and car-mounted chargers, etc.

Battery Pack Simulating Function

- Multi-Channel Battery Pack Simulation
- Battery Pack Charging/Discharging Simulation
- Battery Behavior Curve Setting
- Starting Voltage and Capacity Initializing
- Battery Pack Total Capacity Setting
- Charging and Discharging Efficiency Setting
- Battery DCR Simulation
- Battery Pack Initialization Cycle Simulation
- Single Channel Bidirectional Power Supply

Battery Pack Protection

- OCP
- OVP
- Battery High Voltage/Power Warning
- Battery Low Voltage/Power Warning
- Battery OVP/OPP
- Battery LVP/LPP

Single Channel Bidirectional Power Supply

- Voltage /Current /Power Display
- Voltage /Current Setting
- Pre-charge Function: Set the time required to generate voltage

Real Time Test Data Display

- Voltage /Current /Power Value Display
- Voltage /Current /Power Picture Display
- Battery Pack Charging/Discharging Curve Display
- Testing Report Output Function

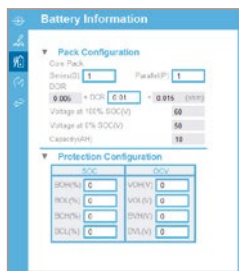
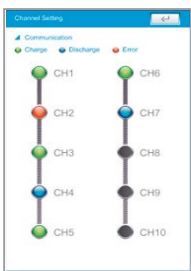

Motor Driver Testing for Vehicle 48V Start-stop System

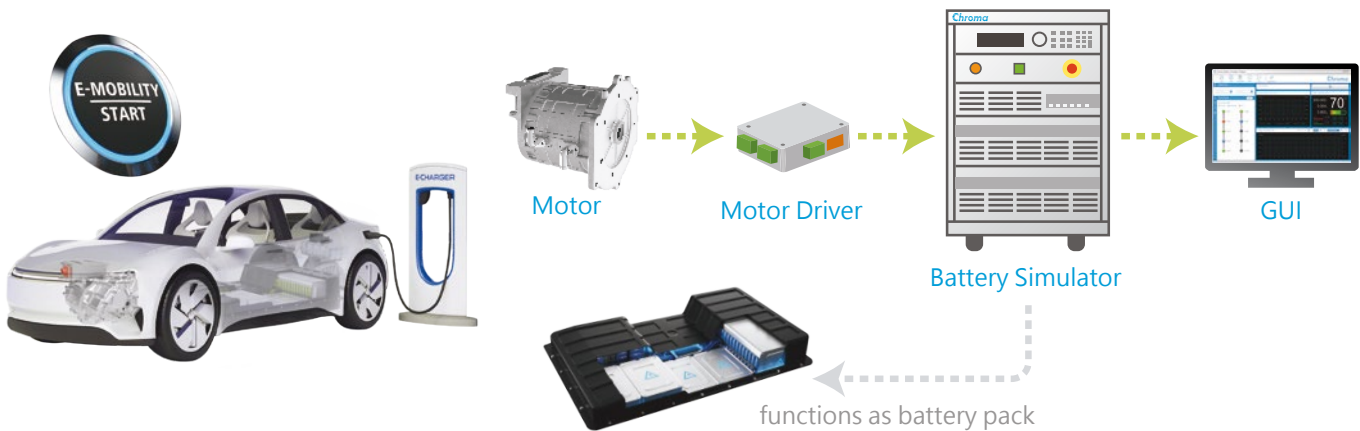

Battery Pro - Operation Interface of the Battery Simulator

An optional battery simulator can be used with the 17020 to charge and discharge the bidirectional power supply. Furthermore, it can set the battery capacity, DCR, and V-SOC curve to be downloaded for charger, inverter, and motor driver testing via the proprietary software enclosed.

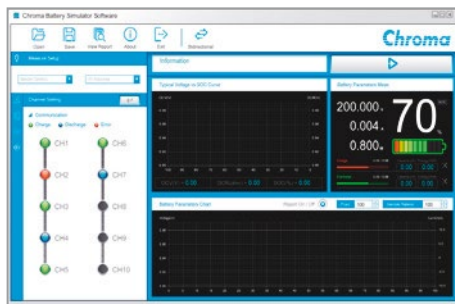

Battery simulator main window

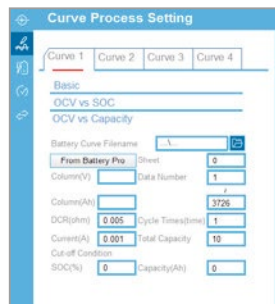

DCR setting

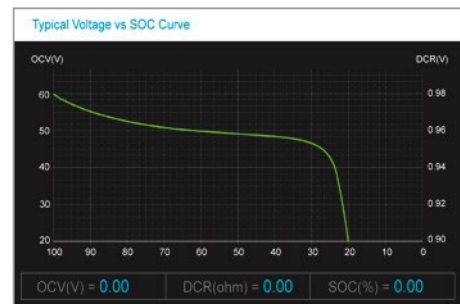

Battery characteristics V-SOC curve setting screen

SPECIFICATIONS

Model	17020						
Voltage	20V	60V	60V	60V	100V	200V	500V
Current	65A	13A	62.5A	62.5A	50A	30A	13A
Power	1.25kW	600W	1.25kW	2.5kW	2.5kW	2.5kW	2.5kW
Channels	4~40	8~56	4~40	4~24	4~24	4~24	4~24
Max. Power (Parallelable)	50kW	33.6kW	50kW	60kW	60kW	60kW	60kW
Max. Current (Parallelable)	2600A	728A	2500A	1500A	1200A	720A	312A
Battery Cycler							
Charge / Discharge Mode per channel							
Voltage Range*1	0~20V	0~60V.	0~60V	0~60V	0~100V	0~200V	0~500V *3
Voltage Accuracy	0.1% stg.+ 0.05% F.S.	0.1% stg.+ 0.05% F.S.	0.1% stg. + 0.05% F.S.	0.1% stg. + 0.05% F.S.	0.1% stg. + 0.05%F.S.	0.1% stg. + 0.05%F.S.	0.1% stg. + 0.05%F.S.
Voltage Resolution	0.5mV	1mV	1mV	1mV	3mV	5mV	10mV
Current*2	65A	13A	62.5A	62.5A	50A	30A	13A
Current Accuracy	0.1% stg.+ 0.05% F.S.	0.1% stg. + 0.05% F.S.	0.1% stg. + 0.05% F.S.	0.1% stg. + 0.05% F.S.	0.1% stg. + 0.05%F.S.	0.1% stg. + 0.05%F.S.	0.1% stg.+ 0.05% F.S.
Current Resolution	5mA	1mA	5mA	5mA	5mA	5mA	1mA
Power	1.25kW	600W	1.25kW	2.5kW	2.5kW	2.5kW	2.5kW
Power Accuracy	0.2% stg.+ 0.1% F.S.	0.2% stg. + 0.1% F.S.	0.2% stg. + 0.1% F.S.	0.2% stg. + 0.1% F.S.	0.2% stg. + 0.1%F.S.	0.2% stg. + 0.1%F.S.	0.2% stg.+ 0.1% F.S.
Power Resolution	0.1W	0.1W	0.3W	0.3W	0.5W	0.5W	0.5W
Measurement per channel							
Voltage Range	0~20V	0~60V	0~60V	0~60V	0~100V	0~200V	0~500V
Voltage Accuracy	0.02% rdg. + 0.02% F.S.	0.02% rdg. + 0.02% F.S.	0.02% rdg. + 0.02% F.S.	0.02% rdg. + 0.02% F.S.	0.02% rdg. + 0.02% F.S.	0.02% rdg. + 0.02% F.S.	0.02% rdg. + 0.02% F.S.
Voltage Resolution	0.5mV	1mV	1mV	1mV	3mV	5mV	10mV
Current Range	24A/65A	4.8A/13A	24A/62.5A	24A/62.5A	20A/50A	12A/30A	4.8A/13A
Current Accuracy	0.1% rdg. + 0.05% rng.	0.05% rdg. + 0.05% rng.	0.1% rdg. + 0.05% rng.	0.1% rdg. + 0.05% rng.	0.1% rdg. + 0.05% rng.	0.1% rdg. + 0.05% rng.	0.1% rdg. + 0.05% rng.
Current Resolution	5mA	1mA	5mA	5mA	5mA	5mA	1mA
Power Range	1.25kW	600W	1.25kW	2.5kW	2.5kW	2.5kW	2.5kW
Power Accuracy	0.12% rdg. + 0.07% rng.	0.12% rdg. + 0.07% rng.	0.12% rdg. + 0.07% rng.	0.12% rdg. + 0.07% rng.	0.12% rdg. + 0.07% rng.	0.12% rdg. + 0.07% rng.	0.12% rdg. + 0.07% rng.
Power Resolution	0.1W	0.1W	0.3W	0.3W	0.5W	0.5W	0.5W

Battery Simulator	
Internal resistance setting	10mΩ ~1Ω
Output Noise (0~20MHz)	
Voltage Ripple(P-P)	0.5% F.S.
Voltage Ripple(rms)	0.1% F.S.
Transient Response Time *4	10 ms
Bi-directional Transient Response Time *5	20 ms
Road Regulation	< 0.1% F.S.
Program time *6	< 1s

Others - 17020 Power / Channels							
Voltage	20V	20V	20V	20V	60V	60V	60V
Current	130A	260A	520A	2600A	125A	125A	250A
Power	2.5KW	5KW	10KW	50KW	2.5KW	5KW	10KW
Channels	2 - 20	1 - 10	1 - 5	1	2 - 20	2 - 12	1 - 6
Model 17020							
Voltage	60V	60V	60V	100V	100V	100V	100V
Current	500A	750A	1500A	100A	200A	400A	600A
Power	20KW	30KW	60KW	5KW	10KW	20KW	30KW
Channels	1 - 3	1 - 2	1	2 - 12	1 - 6	1 - 3	1 - 2
Model 17020							
Voltage	200V	200V	200V	500V	500V	500V	500V
Current	60A	120A	60A	26A	52A	156A	312A
Power	5KW	10KW	30KW	5KW	10KW	30KW	60KW
Channels	2 - 12	1 - 6	1 - 2	2 - 12	1 - 6	1 - 2	1

• Continued on next page →

GENERAL SPECIFICATIONS

Temperature Coefficient	
Voltage / Current	50ppm/ °C
AC Power	
Voltage Range	1 Ø 200~240V ± 10% 3Ø 200~220Vac ± 10% V _{LL} 3Ø 380~400Vac ± 10% V _{LL} 47~63Hz for input AC power
Current THD	< 5% at rated power
Power Factor	> 0.9 at rated power
Controller to PC	
Data Acquisition Rate to PC *7	Minimum 40ms@ 4CH independent Minimum 10ms@ 4CH parallel Minimum 600ms@ 60CH independent Minimum 100ms@ 60CH parallel
Others	
Protection	OVP, UVP, OCP, OQP, OTP, ODVP, UDVP, ODCP, UDCP, OPP, FAN (system protection), Short (system protection)
Efficiency (Typical)	85~90% at 20% rated power
Operating Temperature	0°C ~ 40°C
Storage Temperature	-40°C ~ 85°C
Operating Humidity	10 ~ 90% RH, non-condensing
Safety & EMC	CE
Dimension (H x W x D)	
5kW ~ 20kW	120cm x 60cm x 90cm
20kW ~ 30kW	170cm x 60cm x 90cm
40kW ~ 60kW	170cm x 60cm x 90cm x 2 racks

17020 V-I CURVE OF OPERATING

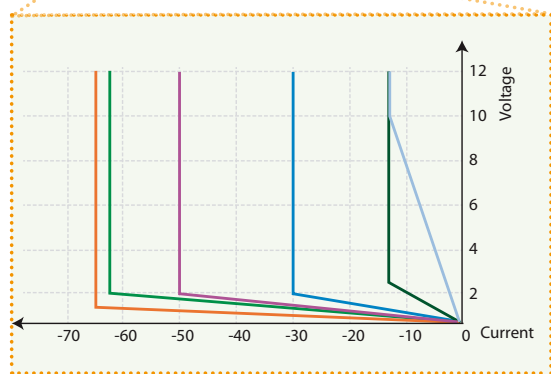
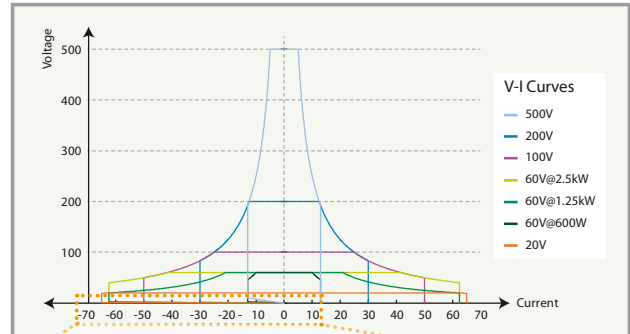

Low Voltage Discharge



A692001 (8CH)

- Note *1 : The output range of voltage is referred by the cabling.
- Note *2 : The connection between the device and battery is 3 meters long as standard accessory. The maximum discharge current will derate at low voltage range, please refer the detail V-I curve.
- Note *3 : The voltage range of the battery simulator and the constant voltage mode is 45V to 500V.
- Note *4 : When the rated load change from 10% to 90%, the item is stability time of voltage.
- Note *5 : When the bi-directional rated load change from -90% to 90%, the item is stability time of voltage.
- Note *6 : The spending time from zero to the maximum voltage is at no-load condition.
- Note *7 : 20µs sampling rate for calculating battery capacity and energy.

ORDERING INFORMATION

Regenerative Battery Pack Test System Model 17020			
Power Range	Voltage	Current	Channels
600W	60V	13A	8~56
1.25kW	20V / 60V	65A / 62.5A	4~40
2.5kW	20V / 60V / 60V / 100V / 200V / 500V	130A / 125A / 62.5A / 50A / 30A / 13A	4~20
5kW	20V / 60V / 60V / 100V / 200V / 500V	260A / 250A / 125A / 100A / 60A / 26A	2~10
10kW	20V / 60V / 60V / 100V / 200V / 500V	520A / 500A / 250A / 200A / 120A / 52A	1~5
20kW	20V / 60V / 60V / 100V / 200V / 500V	1040A / 1000A / 500A / 400A / 240A / 104A	1~3
50kW	20V / 60V / 60V / 100V / 200V / 500V	2600A / 2500A / 1250A / 1000A / 600A / 260A	1
60kW	60V / 100V / 200V / 500V	1500A / 1200A / 720A / 312A	1

Others and Options	
51101-64	Thermal/Multi-function Data logger, 64 channels
HIOKI 8423/8948	Data logger measurement unit
HIOKI 9683	Connection cable caption for HIOKI 8423
A170201	IPC for battery test system
A170202	Battery simulator softpanel
A692003	Thermal sensor with cable
A692000	BMS data communication unit, 4 Channels
A692001	BMS data communication unit, 8 Channels