

Analog Signal Generator Model AP5002A

Compact Microwave Signal Generators 9 kHz to 12, 20, or 26 GHz



dataTec

Mess- und Prüftechnik. Die Experten.

Ihr Ansprechpartner /
Your Partner:

dataTec AG
E-Mail: info@datatec.eu
datatec.eu

KEYSIGHT
Authorized Premium
Distributor

Definitions and Conditions

Specification (spec):

The specifications (called out as spec) in the following pages describe the warranted performance of a calibrated instrument for $23 \pm 5 \text{ }^\circ\text{C}$ after a 30-minute warm-up period (unless otherwise stated). Specifications include guard-bands to account for the expected statistical performance distribution, measurement uncertainties, and changes in performance due to environmental conditions.

Nominal (nom):

Values indicate the expected mean or average performance, or a parameter whose performance is by design, such as the 50-ohm connector. This data is not warranted and is measured at room temperature (approximately $25 \text{ }^\circ\text{C}$).

Parameters & Specifications

Frequency

Parameter	Nominal (Unless otherwise indicated)	Note
Frequency range	9 kHz to 12 GHz	AP5002A-512
	9 kHz to 20 GHz	AP5002A-520
	9 kHz to 26 GHz	AP5002A-526
Resolution	0.001 Hz	
Phase resolution	0.1 deg	
Frequency / Amplitude settling time	200 μs	
	30 μs	Options UNZ, UNQ
	$\leq 20 \text{ ms}$	Only when crossing option 1E1 power ranges including manual 1E1 selection via SCPI command ¹
Internal reference frequency	100 MHz	
Initial accuracy of internal reference	$\pm 40 \text{ ppb}$	calibrated at $23 \pm 3 \text{ }^\circ\text{C}$ at the time of calibration, user adjustable
Temperature stability (0 to $45 \text{ }^\circ\text{C}$)	$\pm 100 \text{ ppb}$	
Aging 1 st year	0.5 ppm	
Aging per day (after 30 days of operations)	5 ppb	
Warm-up time	5 min	
Internal reference output range	10 MHz, 100 MHz	Both 10 MHz and 100 MHz reference output are available on the REF OUT port.
Internal reference output power	0 dBm	
Internal reference output impedance	50 Ω	

¹ With manual 1E1 selection, the user can move the fast dynamic range (30 μs settling time with UNZ/UNQ) to a power range lower than -20 dBm, as long as 1E1 power ranges are not being crossed during the signal change.

Bypass internal reference input	100 MHz, -5 to +10 dBm	High phase synchronous mode
Phase lock to ext. ref. input range	1 MHz to 250 MHz	User programmable
Reference input level	-5 to +13 dBm	
Lock range	±1.5 ppm	
Reference input impedance	50 Ω	

Output Power

Parameter	Min	Max (spec)	Note
Power Level Range			
Standard	-20 dBm	+12 dBm	9 to < 100 kHz
	-20 dBm	+15 dBm	100 kHz to 25 GHz
	-20 dBm	+10 dBm	> 25 to 26 GHz
With Option 1E1	-120 dBm	+12 dBm	9 to < 100 kHz
	-120 dBm	+15 dBm	100 kHz to 25 GHz
	-120 dBm	+10 dBm	> 25 to 26 GHz
With Option 1EA	-20 dBm	+12 dBm	9 kHz to < 100 kHz
	-20 dBm	+20 dBm	100 kHz to < 50 MHz
	-20 dBm	+23 dBm	50 MHz to 7.5 GHz
	-20 dBm	+20 dBm	> 7.5 to 18 GHz
	-20 dBm	+18 dBm	> 18 to 20 GHz
	-20 dBm	+16 dBm	> 20 to 25 GHz
	-20 dBm	+10 dBm	> 25 to 26 GHz
	-20 dBm	+10 dBm	> 25 to 26 GHz
With Option 1E1 and 1EA	-120 dBm	+12 dBm	9 to < 100 kHz
	-120 dBm	+20 dBm	100 kHz to < 50 MHz
	-120 dBm	+23 dBm	50 MHz to 7.5 GHz
	-120 dBm	+20 dBm	> 7.5 to 18 GHz
	-120 dBm	+18 dBm	> 18 to 20 GHz
	-120 dBm	+16 dBm	> 20 to 25 GHz
	-120 dBm	+10 dBm	> 25 to 26 GHz
	-120 dBm	+10 dBm	> 25 to 26 GHz
Resolution	0.01 dB		

Level Accuracy

(ALC mode on, flatness correction: up to 2,000 points, temperature effects: 0.015 dB/ °C (typical) in range 0 to 45 °C). Nominal unless otherwise indicated.

Power range	> +15 dBm to P _{max}	-15 to +15 dBm	-70 to < -15 dBm	< -70 to -120 dBm
9 kHz to 10 GHz	±1.6 dB (spec), ±0.8 dB	±1.0 dB (spec), ±0.3 dB	±1.5 dB (spec), ±0.4 dB	±1.8 dB
10 GHz to f _{max}	±1.6 dB (spec), ±0.8 dB	±1.0 dB (spec), ±0.3 dB	±1.5 dB (spec), ±0.4 dB	±2.0 dB

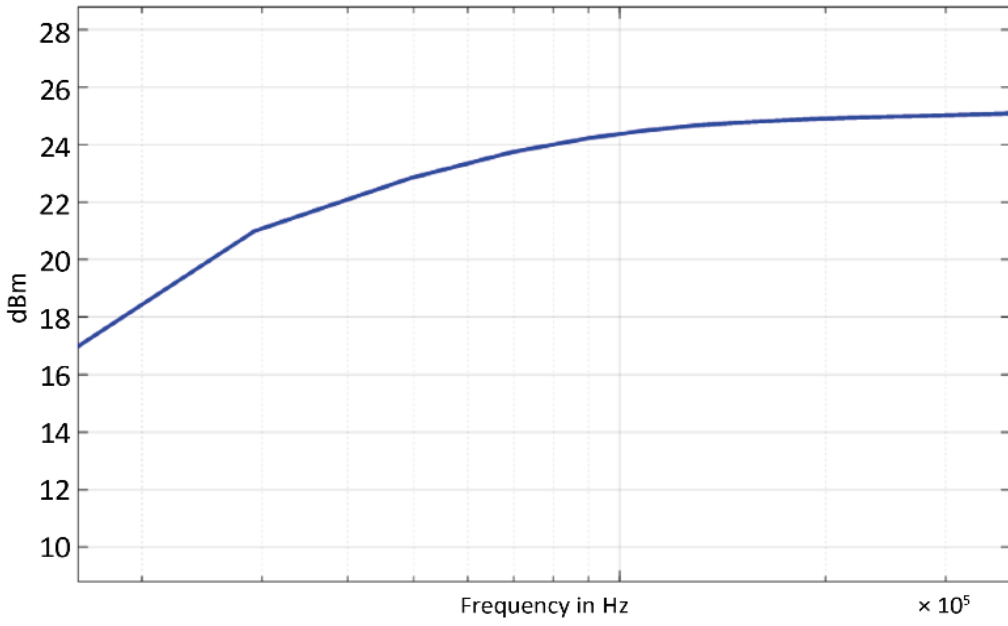

Figure 1. Nominal maximum output power, 9 kHz to 1 MHz, with Option 1EA

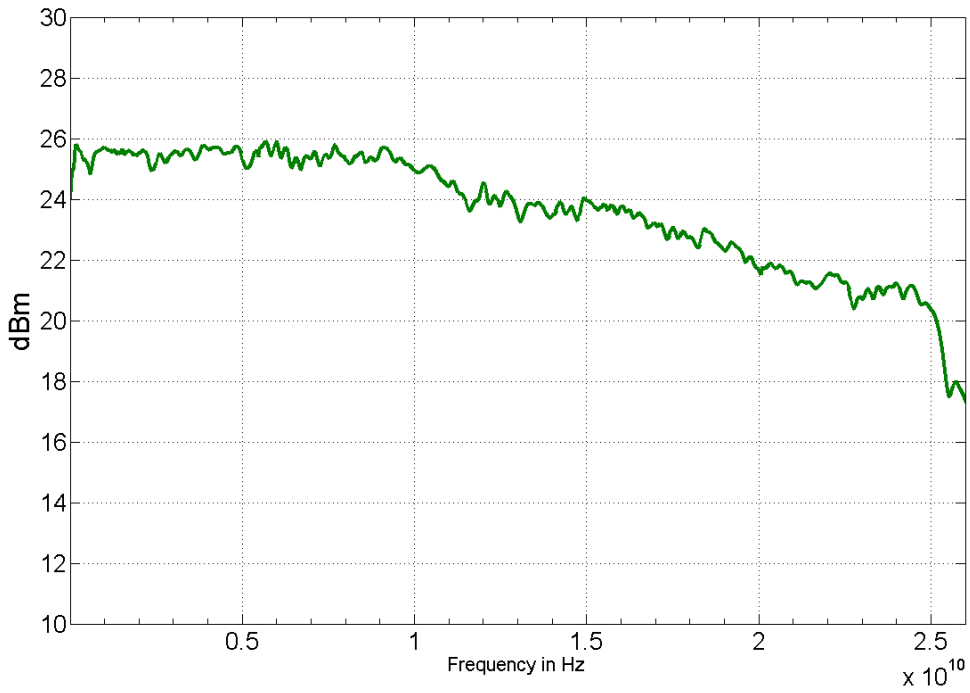

Figure 2. Nominal maximum output power, 100 kHz to 26 GHz, with Option 1EA

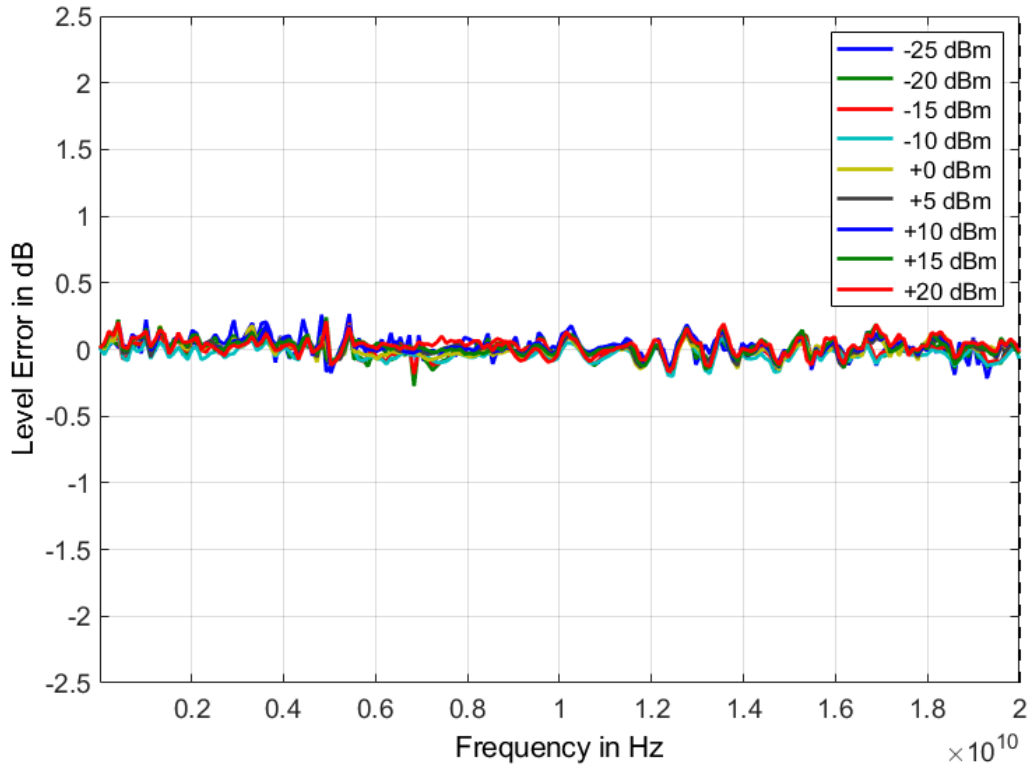

Figure 3. Nominal frequency response, 0 to 20 GHz, at -20, 0, and +20 dBm

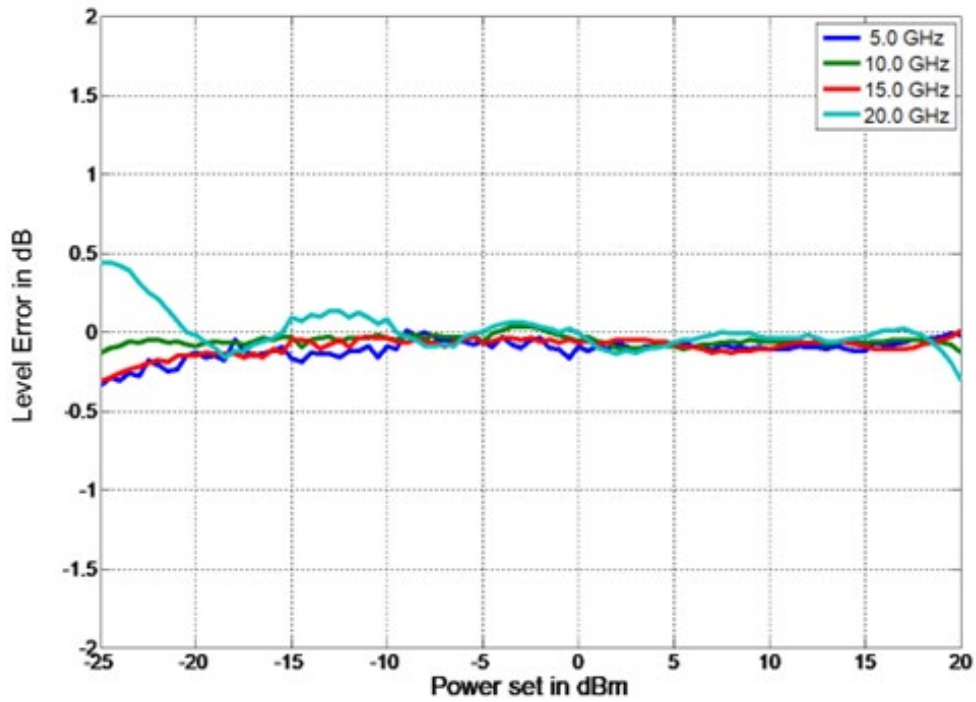

Figure 4. Nominal Absolute power level error, 0 to 20 GHz, at -20, 0, and +20 dBm

Reverse Power Protection and VSWR

Parameter	Nominal	Note
Reverse Power Protection		
DC voltage	5 V	
RF power	+27 dBm	
Output impedance	50 Ω	
VSWR	1.5	≤ 6 GHz
	2.0	> 6 GHz

Phase Noise

Parameter	Nominal
SSB Phase Noise	
1 GHz, 20 kHz offset	-130 dBc/Hz
4 GHz, 20 kHz offset	-118 dBc/Hz
20 GHz, 20 kHz offset	-104 dBc/Hz
Wideband noise	-150 dBc/Hz
Amplitude noise at 10 GHz	-130 dBc/Hz

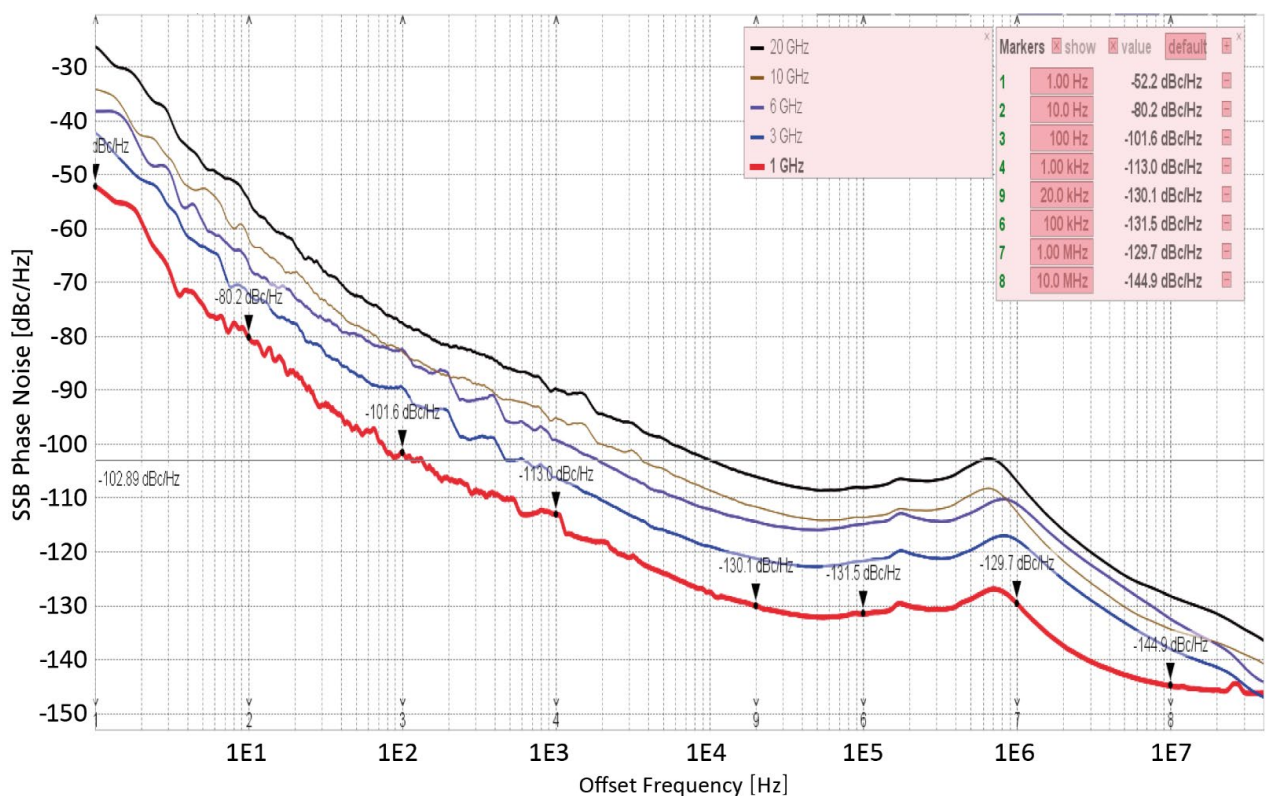

Figure 5. Nominal phase noise at different frequencies, 1 Hz to 100 MHz offset

Spectral Purity

Parameter	Nominal	Spec	Note
Output harmonics	-40 dBc	-30 dBc	$P_{out} = +5$ dBm, 2 nd and 3 rd harmonics tested to 40 GHz
Sub-harmonics	-75 dBc		$F_{carrier} \leq 20$ GHz
	-50 dBc		$F_{carrier} > 20$ GHz
Non-Harmonic Spurious			
	Nominal		
≤ 312 MHz	-80 dBc		CW, $P_{out} = +10$ dBm, > 3 kHz offset
> 312 to 625 MHz	-75 dBc		CW, $P_{out} = +10$ dBm, > 3 kHz offset
> 625 MHz to 1.5 GHz	-75 dBc		CW, $P_{out} = +10$ dBm, > 3 kHz offset
> 1.5 to 2.5 GHz	-70 dBc		CW, $P_{out} = +10$ dBm, > 3 kHz offset
> 2.5 to 5 GHz	-65 dBc		CW, $P_{out} = +10$ dBm, > 3 kHz offset
> 5 to 10 GHz	-60 dBc		CW, $P_{out} = +10$ dBm, > 3 kHz offset
> 10 to 20 GHz	-55 dBc		CW, $P_{out} = +10$ dBm, > 3 kHz offset
> 20 GHz	-50 dBc		CW, $P_{out} = +10$ dBm, > 3 kHz offset
Residual FM at 10 GHz	15 Hz		0.3 kHz to 3 kHz, weighted, (ITU-T), RMS
Residual AM at 10 GHz	0.02%		RMS value (0.01 kHz to 15 kHz)

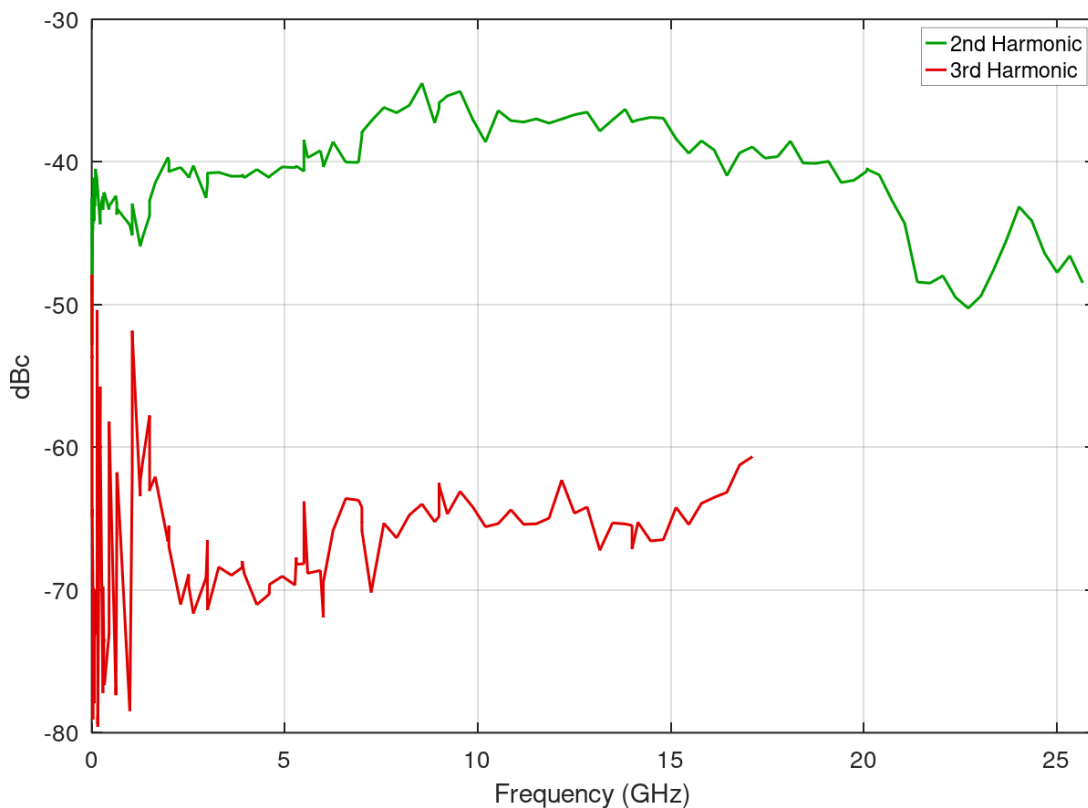

Figure 6. Nominal harmonics, $P_{out} = +5$ dBm

Sweeping Capability

Sweeps can be performed with combined internal or external AM/FM/PM/Pulse modulation running. With modulation enabled, the minimum switching speed increases to 2 ms.

Parameter	Nominal	Note
Digital Power / Frequency / List Sweep (Sweep Type: Linear, Logarithmic, Random)		
Switching Speed (t_{switch}) ² $t_{switch} = t_{delay} + t_{settling}$	400 μ s to 19998 s	standard
	≤ 40 μ s (spec)	Option UNZ
	≤ 40 μ s (spec)	$f_{step} < 2.2$ GHz, Option UNQ
	100 μ s	$f_{step} \geq 2.2$ GHz, Option UNQ
	≤ 20 ms	Only when crossing option 1E1 power ranges including manual 1E1 selection via SCPI command ³
Setup time (t_{setup})	≥ 10 μ s	Time required, after settling, for unit to be ready to accept another trigger
On-time (dwell time) range	0 to 21 s	Pulse on time in pulsed sweep or list sweep
Off-time range (incl. settling time)	0 to 21 s	Pulse off time in pulsed sweep or list sweep
Settling time ($t_{settling}$)	270 μ s	
	30 μ s	Options UNZ, UNQ
Timing delay (t_{delay})	2 to 10 μ s	Trigger input to start of transition
	100 ns	Trigger input to start of transition, options UNZ, UNQ
Time resolution	0.1 μ s	
	5 ns	Options UNZ, UNQ
Timing accuracy per point	3 μ s	
	5 ns	Options UNZ, UNQ
Sweep list length	2 to 10000	

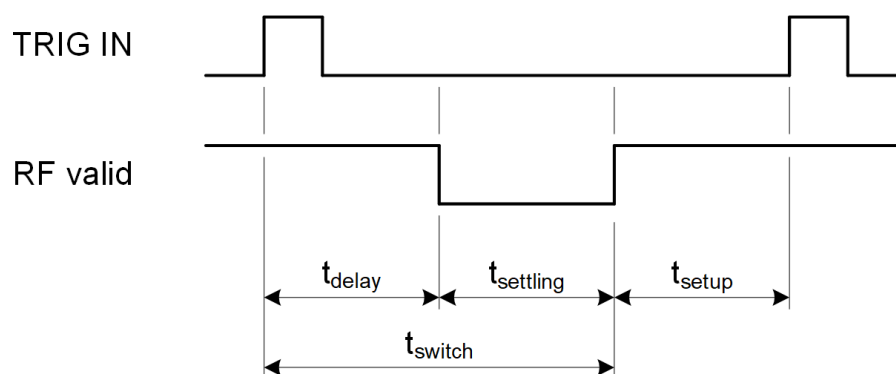

Figure 7. Timing diagram

² Switching speed is defined as the time it takes, after receipt of trigger, to change frequency or amplitude and settle to 1000 ppm of its final value or within 1000 Hz, whichever is greater.

³ With manual 1E1 selection, the user can move the fast dynamic range (30 μ s settling time with UNZ/UNQ) to a power range lower than -20 dBm, as long as 1E1 power ranges are not being crossed during the signal change.

Modulation Capabilities

All modulation types (FM, PM, AM, and pulse modulation) may be enabled simultaneously except that FM and phase modulation cannot be combined. For example, AM and FM can run concurrently and will modulate the output RF.

Parameter	Nominal (Unless otherwise indicated)	Note
Pulse Modulation		
On/off ratio	75 dB	at +10 dBm
Repetition frequency range	DC to 10 MHz	
Pulse width range	100 ns to 5 s	ALC mode hold (ALC locked allowing for faster modulations that would otherwise exceed ALC bandwidth)
	30.281 ns to 5 s	ALC mode hold (ALC locked allowing for faster modulations that would otherwise exceed ALC bandwidth), Option UNQ, UNZ
	500 ns	ALC mode on
Pulse rise/fall time	30 ns	< 5 GHz
	5 ns	> 5 GHz
Duty cycle range	0.05% to 99.95%	
Pulse resolution	30.281 ns	
	5 ns	Options UNQ, UNZ
Polarity	selectable	
External input threshold range	0.85 V to 0.95 V	TTL compatible
External input voltage range	-0.5 V to +5.5 V	TTL compatible
External input hysteresis	60 mV	
Delay (to RF) range	20 ns to 40 ns	
Pulse Pattern Modulation		
Pulse bit width	100 ns to 21 s	ALC mode hold (ALC locked allowing for faster modulations that would otherwise exceed ALC bandwidth)
	30.281 ns to 21 s	ALC mode hold (ALC locked allowing for faster modulations that would otherwise exceed ALC bandwidth) Options UNQ, UNZ
	500 ns to 21 s	ALC mode on
Programmable pattern length	2 to 4096	
Duty cycle	0.05% to 99.95%	
Pulse bit resolution	30.281 ns	
	5 ns	Options UNQ, UNZ
Polarity	selectable	

Parameter	Nominal (Unless otherwise indicated)	Note
N-Pulse modulation		Requires Option UNQ or UNZ
Period range	30 ns to 21 s	
N-Pulse type	1 - 4	No overlapping with other pulses
N-Pulse width range (P1, P2, P3, P4 Widths) individually settable	30 ns to 21 s	ALC mode hold (ALC locked allowing for faster modulations that would otherwise exceed ALC bandwidth)
	500 ns to 21 s	ALC mode on
N-Pulse delay (P1 Delay)	0 ns to 21 s	
N-Pulse delay (P2, P3, P4)	Min: end of prior pulse + min off time	
N-Pulse width and delay resolution	5 ns	
N-Pulse off time range	1 μ s to 21 s	Determined by pulse delay and prior pulse width

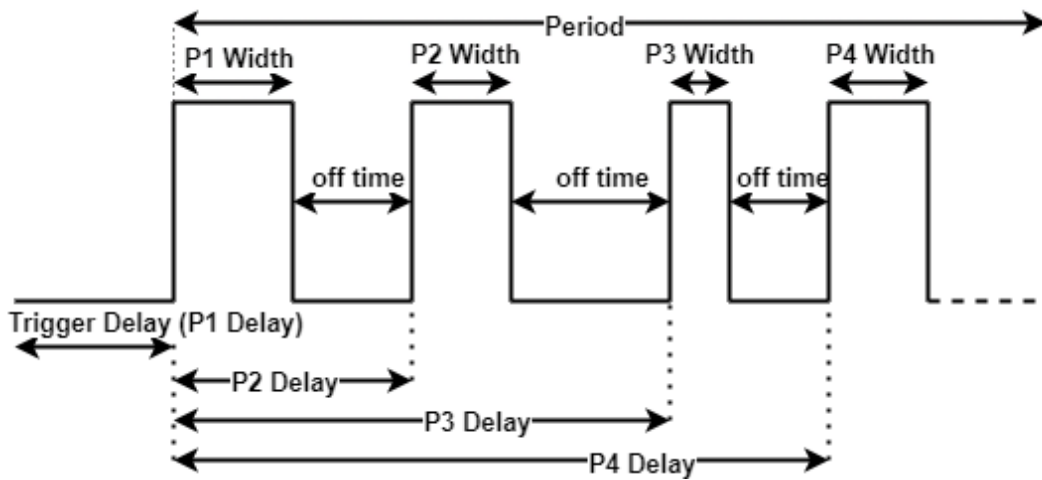

Figure 8. N-Pulse modulation

Frequency modulation		
Maximum frequency deviation (peak)	0 to 0.05 x f	< 0.5 GHz
	0 to N x 200 MHz	0.5 to < 2.5 GHz (N=0.125) 2.5 to < 5 GHz (N=0.25) 5 to < 10 GHz (N=0.5) ≥ 10 GHz to 26 GHz (N=1)
Deviation accuracy	0.5% to 2%	≤ 100 kHz rate
	2% to 5%	> 100 kHz rate
Distortion	< 1%	1 kHz rate, 50 kHz deviation
Modulation rate range	DC to 100 kHz	> -3 dB frequency response
Modulation waveforms	Sine, triangle, FSK	

External input sensitivity	0 to N x 200 MHz / V AC coupled	Adjustable for ± 1 V range
	0 to N x 100 MHz / V DC coupled	Discrete values; ± 5 V range
External input impedance	600 Ω	
	1 M Ω	Option MDH
Total harmonic distortion	< 1%	1 kHz rate & N x 1 MHz deviation
Frequency Chirps (Linear Ramp, Up/Down)		
Span	0 to 10%	Of carrier frequency
Chirp rate	< 1 Hz to 100 MHz	
Chirp time range (t_{chirp})	10 ns to 60 s	
Slope	100 MHz/ μ s	
Total duration of finite repeated chirps (t_{chirp} x repetitions)	64.1 s	
	21.4 s	Option UNQ or UNZ
Number of frequencies	65,000	
Phase Modulation		
Phase deviation range (peak)	0 to 500 nrad/Hz	< 500 MHz
	0 to N x 300 rad	0.5 to < 2.5 GHz (N=0.125) 2.5 to < 5 GHz (N=0.25) 5 to < 10 GHz (N=0.5) ≥ 10 GHz to 26 GHz (N=1)
Deviation accuracy	0.5% to 2%	≤ 100 kHz rate
	2% to 5%	> 100 kHz rate
Modulation rate range	DC to 100 kHz	> -3 dB frequency response Max. phase deviation degrades above 20 kHz modulation rate
Modulation waveforms	Sine, triangle, FSK	
External input sensitivity	Settable 0.1 rad/V to 360 rad/V	
External input impedance	600 Ω	
	1 M Ω	Option MDH
Total harmonic distortion	< 1%	1 kHz rate & N x 100 rad deviation
Amplitude Modulation		
Modulation rate range	0.1 Hz to 50 kHz	Applies to internal and external
Modulation depth	95%	settable
Modulation waveforms	Sine, triangle, square	
Accuracy (f < 10 MHz)	1.3 % (nom), 4 % (spec)	f-carrier, modulation depth = 80% & 1 kHz modulation rate, power 0 dBm Specifications apply to internal modulator only.
Distortion (f < 10 MHz)	1.6 % (nom), 4 % (spec)	
Accuracy (f ≥ 10 MHz)	1.6% (nom) to 4% (spec)	
Distortion (f ≥ 10 MHz)	1 % (nom), 4% (spec)	
External Input range	0 to 5 V	to GND

Multi-Purpose Output (FUNC OUT)

Parameter	Nominal	Note
Multifunction Generator (Sine, Triangle, Square Wave)		
Frequency range	10 Hz to 3 MHz	sine
	10 Hz to 1 MHz	triangle
	10 Hz to 50 kHz	square
Frequency resolution	0.1 Hz	
Output voltage amplitude range (peak-peak)	10 mV to 2 V	sine, triangle
	5V	square (CMOS output)
Harmonic distortion	1 %	< 100 kHz, 1 Vpp
Output impedance	50 Ω	sine, triangle
	CMOS	square
Video Output (Of Internal Pulse Modulator)		
Output	CMOS	
Period range	30 ns to 50 s	
Pulse Width range	15 ns to 50 s	
RF delay	10 ns	
Trigger Out (Synchronization Mode for Multiple Sources)		
Modes	Trigger on sweep start	
	Trigger on each point	
	Signal Valid	Option UNQ or UNZ
Pulse width	100 ns	

Trigger (TRIG IN)

Parameter	Nominal	Note
Trigger types	Continuous, single, gated, gated direction	
Trigger source	RF key, external, bus (LAN, USB)	
Trigger modes	Continuous free run, trigger and run, reset and run	
Trigger latency	2 μ s	
	130 ns	Option UNQ or UNZ
Trigger uncertainty	5 μ s	
	10 ns	Option UNQ or UNZ
External trigger delay range	0 to 40 s	Programmable
	0 to 10 s	Option UNQ or UNZ
External delay resolution	15 ns	
	10 ns	Option UNQ or UNZ

Trigger modulo	1 to 255	Execute only on the N th trigger event
Trigger polarity	Rising, falling	
External trigger input threshold range	0.85 V to 0.95 V	TTL compatible
External trigger input voltage range	-0.5V to + 5.5 V	TTL compatible
External trigger input hysteresis	60 mV	

Connectors

Front (3U Housing)

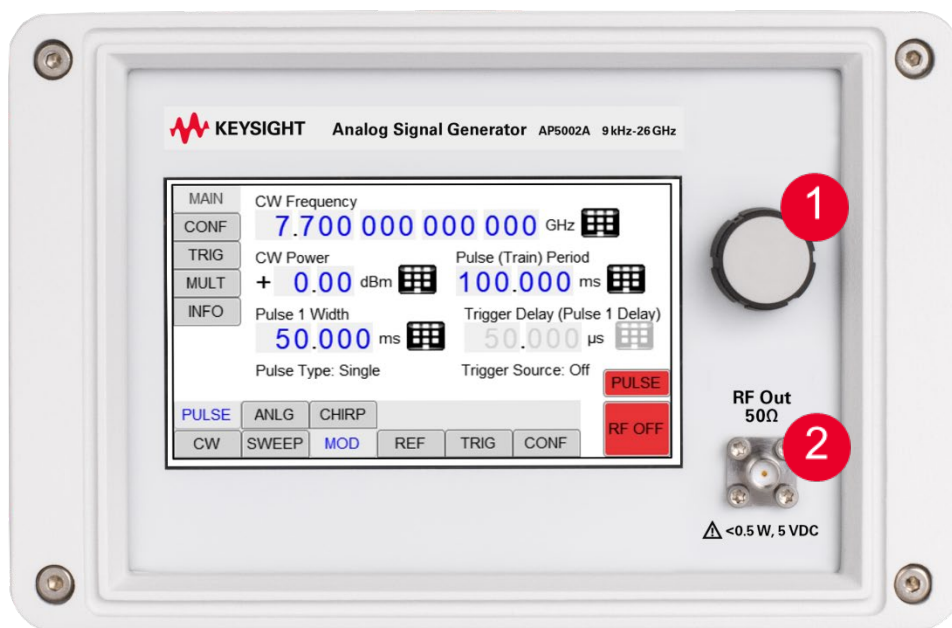

1. **Rotary Knob** changes the value selected on the screen.
2. **RF 50 Ω Output connector** SMA-female

Rear (3U Housing)

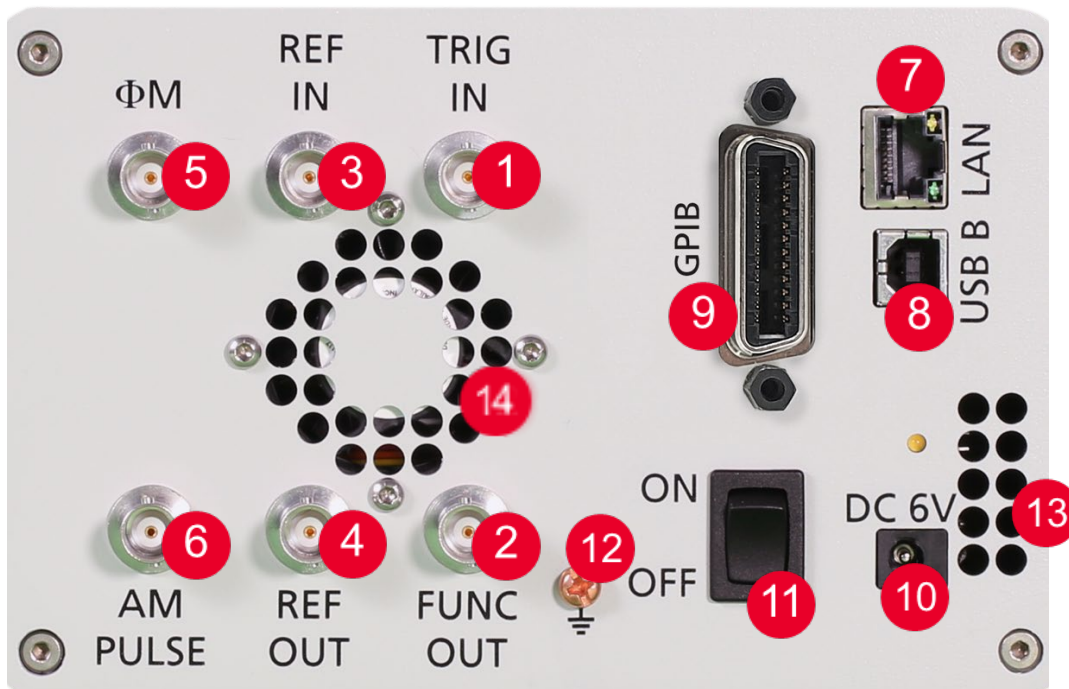

1. **Trigger input** BNC female
2. **Function output** BNC female
3. **External reference input** BNC female
4. **Internal reference output** BNC female
5. **FM/PM modulation** input BNC female
6. **AM and Pulse modulation** BNC female
7. **LAN connection** RJ-45
8. **USB 2.0 device**
9. **GPIB Port**
10. **DC Power plug** (6V, 6 A)
11. **DC power switch**
12. **Ground Screw**
13. **Fan Holes** (air intake)
14. **Fan Holes** (air exit)

Front (Option S1E 1U Housing)



19" rack-mount module, SMA RF output connector

Rear (Option S1E 1U Housing)



1. **Trigger input BNC female**
2. **Function output BNC female**
3. **External reference input BNC female**
4. **Internal reference output BNC female**
5. **FM/PM modulation input BNC female**
6. **AM and Pulse modulation input BNC female**
7. **LAN connection RJ-45**
8. **USB 2.0 device**
9. **GPIB Port**
10. **Ground Screw**

Accessories

Y9614A External Power Bank Adapter Cable (3U Housing Only)

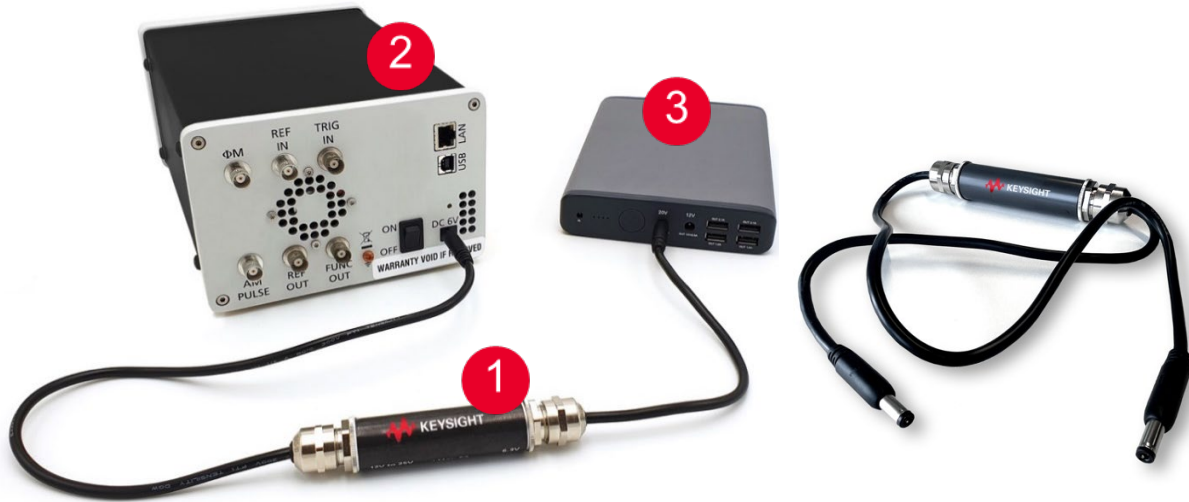

The Y9614A (# 1 above) is designed to power the 3U AP5001A or AP5002A (# 2 above) from an external, customer supplied, power bank (# 3 above) with output voltage of 12V to 25V. Power bank capacity of 50 Ah is recommended and it should be equipped with a barrel connector per below specifications with a maximum output current of 7 A.

The Y9614A has two connectors marked as ‘Input’ and ‘Output’. The output connector is directly connected to the DC 6.3V input port on the rear of an AP5001A or AP5002A. The input connector is directly connected to a customer supplied power bank.

Caution: Do not exchange input and output connectors

Y9614A Specifications

Parameter	Value	Note
Input connector	Barrel connector 2.1 x 5.5 mm, outer sleeve negative	Connected to power bank
Output connector	Barrel connector 2.1 x 5.5 mm, outer sleeve negative	Connected to AP5001A/2A
Input voltage range	12 V to 25 V DC	
Input power consumption	Typ. 36 W	
Output voltage	6.3 V DC	
Output current	Max 5 A	
Cooling	To ensure sufficient passive cooling, air circulation around the module must be possible.	

Y9611A 3U Rack Mount



General Characteristics

Remote programming interfaces	Ethernet 100BaseT LAN interface USB 2.0 host & device Control language SCPI Version 1999 compatible
Power requirements	6.3 ± 0.2 VDC; 30 W maximum
Power requirements (option S1E)	100-240 VAC, 50-60 Hz; 42 W max
Mains adapter supplied (except option S1E)	100-240 VAC in/ 6.3 V 5.71 A DC out
Environmental (Levels similar to MIL-PRF-28800F Class 3/4)	Environmental stress Samples of this product have been type tested to be robust against the environmental stresses of storage, transportation, and end-use; those stresses to temperature, humidity, shock, vibration, altitude, and power line conditions.
Storage temperature range	-40 to 70 °C
Operating temperature range	0 to 55 °C 0 to 45° C with option S1E 40 °C for Y9614A
Max. Relative Humidity	85% up to 45 °C ambient (40 °C for Y9614A)
Operating and storage altitude	up to 15,000 feet
CE	EMC complies and EMC regulations and directives for emission and immunity to interference (EN 61326-1 Industrial, EN/IEC 61326-2-1) Safety complies with applicable Safety regulation in line with IEC/EN 61010-1
Weight	Weight ≤ 4.3 kg (9.5 lbs) net, ≤ 5.4 kg (12 lbs) shipping, Weight S1E ≤ 6 kg (13.23 lbs) net, ≤ 8 kg (17.63 lbs) shipping, Weight (Y9614A empty) ≤ 0.167 kg (0.37 lbs) net
Dimensions	Including connectors: W x L x H = 174 x 262 x 117 mm [6.83 x 10.30 x 4.60 in]
Dimensions (Option S1E)	W x L x H = 426 x 460 x 42 mm [16.8 x 18.1 x 1.7 in]
Recommended calibration cycle	24 months

Ordering Information

Model/Option	Description	Additional Information
AP5002A	RF Microwave Signal Generator	
AP5002A-512	Frequency range, 9 kHz to 12 GHz	
AP5002A-520	Frequency range, 9 kHz to 20 GHz	
AP5002A-526	Frequency range, 9 kHz to 26 GHz	
AP5002A-1E1	Step attenuator	
AP5002A-1EA	High output power	
AP5002A-UNQ	Band limited fast switching	not license upgradeable
AP5002A-UNZ	Fast switching	not license upgradeable
AP5002A-GPB	GPIB interface	not license upgradeable
AP5002A-S1E	1U rack-mount module	not license upgradeable
AP5002A-1EM	Move RF output to rear panel	Requires option S1E, not license upgradeable
AP5002A-UK6	Commercial calibration certificate with test data	
AP5002A-MDH	1 M Ω FM/PM input impedance	not license upgradeable
Y9611A	Rack mount kit, 3HU	
Y9612A	Portable bag	
Y9614A	External power bank adapter cable with voltage converter	For use with customer supplied power bank
AP5002AU-F01	Frequency upgrade from 12 GHz to 20 GHz	License key only
AP5002AU-F02	Frequency upgrade from 12 GHz to 26 GHz	License key only
AP5002AU-F03	Frequency upgrade from 20 GHz to 26 GHz	License key only
AP5002AU-1E1	Add step attenuator	License key only
AP5002AU-1EA	Add high output power	License key only



Mess- und Prüftechnik. Die Experten.

**Ihr Ansprechpartner /
Your Partner:**

dataTec AG

E-Mail: info@datatec.eu

datatec.eu



Keysight enables innovators to push the boundaries of engineering by quickly solving design, emulation, and test challenges to create the best product experiences. Start your innovation journey at www.keysight.com.

This information is subject to change without notice. © Keysight Technologies, 2024 - 2026, Published in USA, March 25, 2026, 3124-1576.EN