



Probes Selection Guide

dataTec

Mess- und Prüftechnik. Die Experten.

**Ihr Ansprechpartner /
Your Partner:**

dataTec AG
E-Mail: info@datatec.eu
datatec.eu

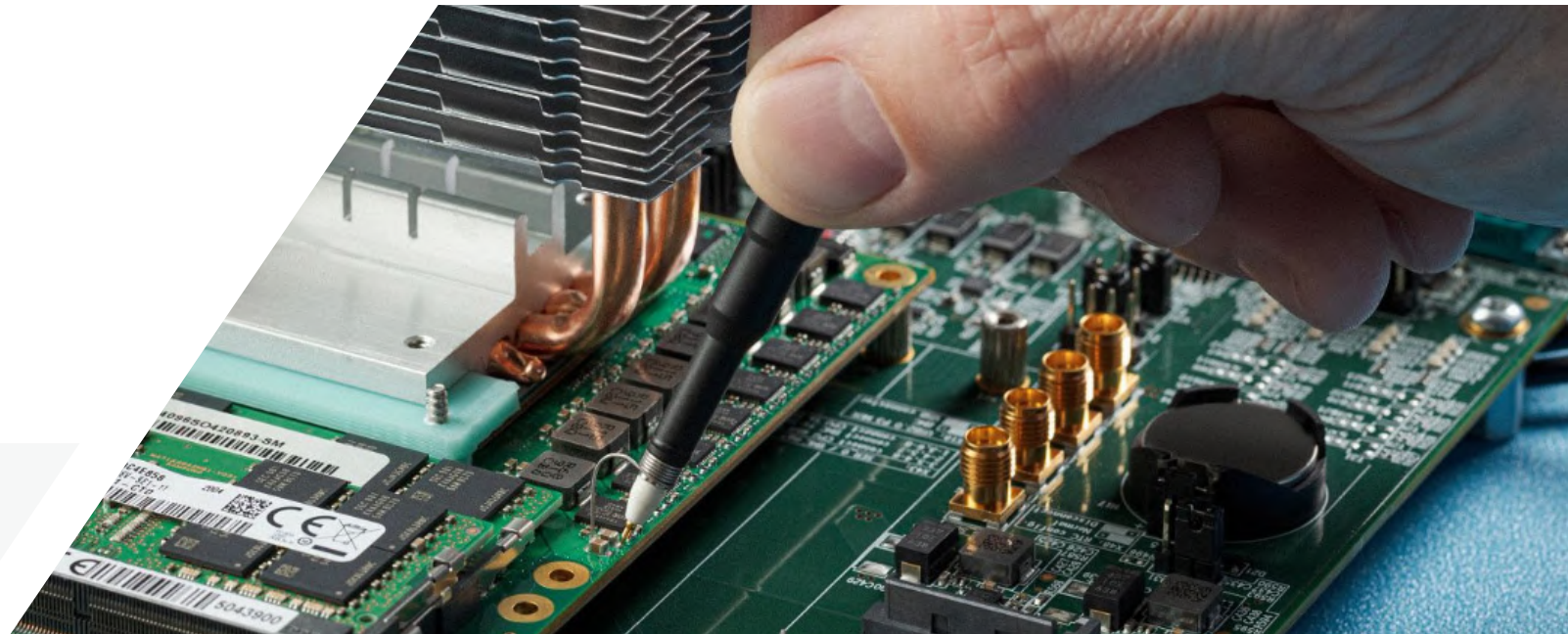

Probe / Oscilloscope Compatibility

PROBE



OSCILLOSCOPE		BNC	TekProbe™ LEVEL 1	TekProbe™ LEVEL 2	TekVPI™	TekVPI™ w/HardKey	FlexChannel™	TekConnect™
	Std BNC 2 Series MSO TDS1000/2000 TBS1000 TPS2000 THS3000	●	● Readout not functional	● 1103 Power Supply (50 Ω termination may be required)				
	TekProbe LEVEL 1	●	●	● 1103 Power Supply (50 Ω termination may be required)				
	TekProbe LEVEL 2 TDS3000 TDS5000 TDS7054/7104	●	●	● ₁				
	TekVPI TBS2000 MSO/DPO2000 MSO/DPO3000 MSO/DPO4000 DPO7000C	●	●	● _{2,7} TPA-BNC	● _{2,3,5}			
	TekVPI w/ HardKey 3 Series MD0 MSO/DPO4000B MD03000/4000C MSO/DPO5000	●	●	● TPA-BNC	● _{4,5}	●		
	FlexChannel 4 Series MSO 5 Series MSO 5 Series MSO LP 6 Series MSO	●	●	● TPA-BNC	●	●	●	
	TekConnect 7 Series DPO MSO/DSA/DPO70000 DPO70000 TDS6000 TDS7154/B, 7254B, 7404B, 7704B, CSA7154, 7404/B	● TCA-BNC	● TCA-1MEG	● TCA-1MEG (ADA400A, P52xx) or TCA-BNC	● TCA-VPI50 (50 Ω probe only)			●

1. Some probes require an external power supply (1103) when used with the TDS3000 series

2. When using with MSO / DPO2000 series, a dedicated AC adapter (119-8726-00) and a power cable (161-0342-00) are required.

3. When using with MSO / DPO3000 series, depending on the probe you may need a separate AC adapter (119-8726-00) and a power cable (161-0342-00).

4. When using with MSO / DPO5000 series, separate AC adapter (119-8726-00) and power cable (161-0342-00) may be required depending on the probe model and number.

5. When using with TBS2000 and MD03000 series, the total power draw capacity can not exceed the maximum power supply capacity of the oscilloscope, see here for more information.

6. Readout does not function in the TBS2000 series.

7. To interface TPCA300 and TPCA400 current probe amplifiers with TBS2000/B and 2 Series MSO, use a 011-0049-xx 50 Ω feedthrough terminator along with a BNC cable instead of the TPA-BNC adapter.

Passive Probes

Passive voltage probes ship standard with most oscilloscopes and provide a low cost, general purpose probing solution. Generally, these probes lack the performance of an active voltage probe but provide the ruggedness and wide dynamic range suitable for visualizing signals over a broad range of applications. Tektronix has released a new class of passive probes that redefine performance in the passive probe product category.

Tektronix new class of passive probe solutions offer:

- Best-in-class bandwidth up to 1 GHz
- Best-in-class input capacitance as low as 3.9 pF which minimizes probe loading effects
- Best-in-class input capacitance which minimizes performance loss when long ground leads are attached
- Automated probe compensation eliminating the need for the compensation screwdriver

Model	Bandwidth	Attenuation	Input Impedance	Maximum Voltage	Interface	Compensation Range
TPP1000	1000 MHz	10X	10 M Ω 3.9 pF	300 V _{rms} (CAT II)	TekVPI w/Key	
TPP0500B	500 MHz	10X	10 M Ω 3.9 pF	300 V _{rms} (CAT II)	TekVPI w/Key	—
TPP0502	500 MHz	2X	2 M Ω 12.7 pF	300 V _{rms} (CAT II)	TekVPI w/Key	—
TPP0250	250 MHz	10X	10 M Ω 4 pF	300 V _{rms} (CAT II)	TekVPI w/Key	—
TPP0051	50 MHz	10X	10 M Ω 12 pF	300 V _{rms} (CAT II)	BNC	15–25 pF
TPP0100	100 MHz	10X	10 M Ω 12 pF	300 V _{rms} (CAT II)	BNC	8–18 pF
TPP0101	100 MHz	10X	10 M Ω 12 pF	300 V _{rms} (CAT II)	BNC	15–25 pF
TPP0200	200 MHz	10X	10 M Ω 12 pF	300 V _{rms} (CAT II)	BNC	8–18 pF
TPP0201	200 MHz	10X	10 M Ω 12 pF	300 V _{rms} (CAT II)	BNC	15–25 pF
P2220	6 MHz, 200 MHz	1X, 10X	1 M Ω 110 pF, 10 M Ω 17 pF	150 V _{rms} (CAT II), 300 V _{rms} (CAT II)	BNC	15–25 pF
P2221	6 MHz, 200 MHz	1X, 10X	1 M Ω 110 pF, 10 M Ω 17 pF	150 V _{rms} (CAT II), 300 V _{rms} (CAT II)	BNC	10–25 pF
P5050B	500 MHz	10X	10 M Ω 11 pF	300 V _{rms} (CAT II)	TekProbe LEVEL1	15–25 pF
P6139B	500 MHz	10X	10 M Ω 8 pF	300 V _{rms} (CAT II)	TekProbe LEVEL1	8–18 pF
P6101B	15 MHz	1X	1 M Ω 100 pF	300 V _{rms} (CAT II)	BNC	—
P3010	100 MHz	10X	10 M Ω 12 pF	300 V _{rms} (CAT II)	TekProbe LEVEL1	10–15 pF
THP0301	300 MHz	10X	10 M Ω 11 pF	300 V _{rms} (CAT II)	BNC	



TPP1000 / TPP0500B



TPP0200 / TPP0100







P6139B



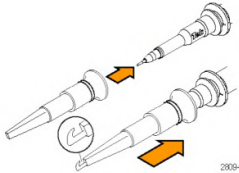
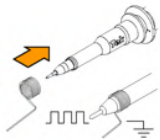
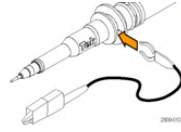
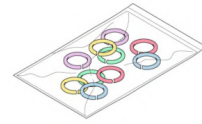
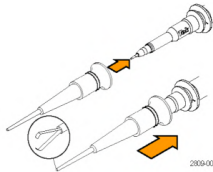
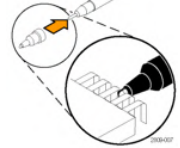







LEARN
MORE 

Passive Probes – Accessories

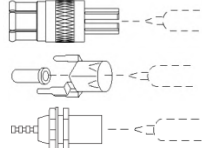

STANDARD ACCESSORIES

<p>Hook Tip 013-0362-xx</p> 	<p>Ground Springs 016-2028-xx (long, 2 ea.) 016-2034-xx (short, 2 ea.)</p> 	<p>Ground Lead, with Alligator Clip 196-3521-x</p> 	<p>Color Bands 016-0633-xx (5 pairs)</p> 
<p>Micro-Hook Tip 013-0362-xx</p> 	<p>Universal IC Cap 013-0366-xx</p> 	<p>Insulator Sleeve 342-1194-xx TPP1000, TPP0500, TPP0502</p>  <p>204-1226-xx TPP0500B, TPP0250, P6139B, P5050B</p> 	<p>Adjustment Tool 003-1433-xx</p> 

OPTIONAL ACCESSORIES

<p>MMCX to Square Pin Adapters 131-9717-xx (0.1 inch - blue) 131-9677-xx (0.062 inch - white)</p>  <p>Adapts MMCX tips to square pins at 0.1 in. or 0.062 in. centers.</p> 	<p>Electrical Y-Lead 196-3556-xx (probe tip to square pin sockets)</p> 	<p>MicroCKT Test Tip 206-0569-xx</p> 	<p>Ground Lead, 6 inch Clip-On 196-3198-xx</p> 
<p>Electrical Y-Lead 196-3434-xx (square pin on 0.1 in. centers, requires 206-0663-xx and 131-9717-xx)</p> 	<p>Rigid/Pogo Probe Tip Adapters 013-0367-xx (tip to BNC) 016-2016-xx (PCB Test Point) 131-4210-xx (Chassis-Mount TP)</p> 	<p>DUT Interface Pin Kit 0.018 inch round solder-in pins 020-3169-xx (qty 20)</p> 	<p>Ground Lead, 12 inch Alligator 196-3512-xx</p> 
		<p>Solder-Aide for Pin Kit Holds 0.018 inch pins 0.062 inch apart for soldering on 0402 SMT parts</p> 	<p>Probe Tip Tripod 352-1170-xx (qty. 2)</p> 

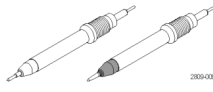
TIP CARTRIDGES

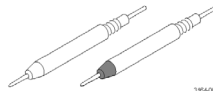
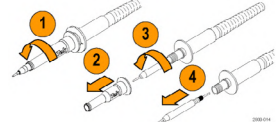
<p>TPP1000 206-0610-xx (rigid tip) 206-0611-xx (pogo tip)</p> 	<p>TPP1000, TPP0502 Shielded MMCX tip mates directly with MMCX connector</p> <p>TPP1000 only 206-0663-xx</p> <p>TPP0502 only 206-0666-xx</p> 
<p>TPP0500B, TPP0250 206-0649-xx (rigid tip) 206-0650-xx (pogo tip)</p> 	<p>TPP0502 206-0641-xx (rigid tip) 206-0642-xx (pogo tip)</p>
<p>P6139B 206-0635-xx (rigid tip)</p> <p>P5050B 206-0636-xx (rigid tip)</p> 	

Active Probes – Low Voltage Single-ended

A low voltage single-ended probe is typically used for measuring high-speed, ground referenced signals up to 12 V. These low voltage probes are the best choice for making measurements on high impedance, high frequency circuit elements which require minimal probe loading. Users should select probes with a low input capacitance specification (<1 pF) to minimize the probe's loading effect on the circuit. A probe with lower input capacitance will offer higher input impedance at higher frequencies.

Tektronix Low Voltage Single-ended Probe solutions offer:

- Bandwidths up to 4 GHz
- Very high input impedance with low input capacitance (<1 pF)
- Most extensive set of probe accessories for optimum measurement performance
- The TAP1500L is equipped with a 7 m cable; Ideal for Flying Probe Testers

Model	Bandwidth	Attenuation	Input Impedance	Dynamic Range	Offset Range	Maximum Non-Destruct Voltage	Interface
TAP4000	4 GHz	10X	40 kΩ ≤ 0.8 pF	±4 V	±10 V	±30 V	TekVPI
TAP2500	2.5 GHz	10X	40 kΩ ≤ 0.8 pF	±4 V	±10 V	±30 V	TekVPI
TAP1500	1.5 GHz	10X	1 MΩ ≤ 1 pF	±8 V	±10 V	±25 V(DC + PkAC)	TekVPI
TAP1500L	1.5 GHz	10X	1 MΩ ≤ 1 pF	±8 V	±10 V	±25 V(DC + PkAC)	TekVPI
P6243	1 GHz	10X	1 MΩ ≤ 1 pF	±8 V	N/A	±15 V(DC + PkAC)	TekProbe LVL2
P6245	1.5 GHz	10X	1 MΩ ≤ 1 pF	±8 V	±10 V	±15 V(DC + PkAC)	TekProbe LVL2

LEARN MORE 



TAPX000



TAP1500L
(7 m cable)



P6243/P6245

Power Rail Probes

The TPR1000 and TPR4000 probes provide a low noise, large offset range solution for measurement of ripple on DC power rails ranging from -60 to +60 VDC. Tektronix's power rail probes offer industry leading low noise and high offset range required to measure AC ripple between 200 μ V p-p and 800 mV p-p at up to 4 GHz.

Key Specs:

- <300 μ V p-p noise on 6 Series MSO (20 MHz BW Limit)
- <1 mV p-p noise on 6 Series MSO (Full Bandwidth)
- \pm 60 V offset range
- Offset setting error: \pm 2 mV max, \pm 0.4 μ V typical

Model	Bandwidth	Attenuation	Input Impedance	Dynamic Range	Offset Range	Interface
TPR4000	4 GHz	1.25X	50 k Ω DC - 10 kHz, 50 Ω AC > 100 kHz	\pm 1 V	\pm 60 V	TekVPI
TPR1000	1 GHz	1.25X	50 k Ω DC - 10 kHz, 50 Ω AC > 100 kHz	\pm 1 V	\pm 60 V	TekVPI

LEARN
MORE 



Power Rail Probes – Accessory Kits

STANDARD ACCESSORIES (TPR4KIT KIT)

1.3m SMA to MMCX Cable
4 GHz
PN#174749700



1.3m SMA to SMA Cable - 4 GHz



MMCX to U.FL adapter - 2 GHz
PN#174749500
PN#174749700



MMCX to square-pin adapter
1GHz
PN#174749600



Solder-Aide for Pin Kit



DUT Interface Pin Kit -
1GHz



TPR4SIACOAX: MMCX to
micro-coax - 4 GHz (set of 3)



TPR4SIAFLEX: MMCX to
performance solder tip
4 GHz (set of 3)



Solderable enameled wire



Probe tip tripod support

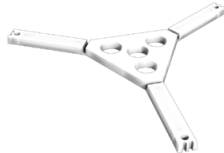

Marker bands



TPRBRWSR1G KIT

Blade ground



SMT Clip



SMA browser - 1GHz



Spring ground

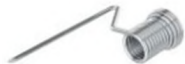

Rigid browser pin - 1GHz



Browser to square-pins - 1GHz



Alligator ground



Pogo browser pin - 1GHz



TPR4KITHT KIT

2m SMA to MMCX High Temp Cable - 4 GHz



TPR4SIACOAX: MMCX to
micro-coax - 4 GHz (set of 3)



TPR4SIAFLEX: MMCX to
performance solder tip
4 GHz (set of 3)



TPR4SIAFLEX KIT

TPR4SIAFLEX: MMCX to performance solder tip - 4GHz
(set of 3)



TPR4SIACOAX KIT

TPR4SIACOAX: MMCX to micro-coax - 4 GHz (set of 3)



Differential Probes – Low Voltage

Differential signaling used in high speed serial standards requires very accurate characterization. The industry-leading bandwidth and signal fidelity found in a Tektronix low voltage differential probe ensures that you see every possible detail.

Model	Bandwidth	Attenuation	Input Impedance	Differential Input Voltage	Operating Window	Offset Range	Interface
TDP4000	≥4 GHz	5X	100 kΩ ≤0.3 pF	±2 V	±15 V (DC + pk AC)	±1 V	TekVPI
TDP3500	≥3.5 GHz	5X	100 kΩ ≤0.3 pF	±2 V	±15 V (DC + pk AC)	±1 V	TekVPI
TDP1500	≥1.5 GHz	1X, 10X	200 kΩ ≤1 pF	1X: ±0.85 10X: ±8.5 V	±25 V (DC + pk AC)	±7.0 V	TekVPI
TDP1000	1 GHz	5X / 50X	1 MΩ ≤1 pF	50X: ±42 V 5X: ±4.2 V	±42 V (DC + pk AC) 30 Vrms	±42 V	TekVPI
TDP0500	500 MHz	5X / 50X	1 MΩ ≤1 pF	50X: ±42 V 5X: ±4.2 V	±42 V (DC + pk AC) 30 Vrms	±42 V	TekVPI
P6248	>1.5 GHz	1X, 10X	200 kΩ <1 pF	1X: ±0.85 10X: ±8.5 V	±7.0 V	depends on scope	TekProbeLVL2
P6247	>1 GHz	1X, 10X	200 kΩ <1 pF	1X: ±0.85 10X: ±8.5 V	±7.0 V	depends on scope	TekProbeLVL2
ADA400A	>1 MHz	.1X - 100X	1 MΩ - 55 pF	.1-80 V**	±10 to ±40 V**	±1 to ±40 V**	TekProbeLVL2

LEARN
MORE



TDP3500/TDP4000



TDP1500



TDP0500



P6247/P6248



ADA400A

Differential Probes - Low Voltage - TDP0500, TDP1000 & TDP1500 Accessories



Straight Pins

Reorder: 016-1891-XX

Usable bandwidth
<1.5 GHz
Typical rise time
<350 ps
Connection type
PCB, Vias, & ICs

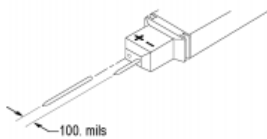

MicroCKT Test Tip

Reorder: 206-0569-XX

Usable bandwidth
<100 MHz
Typical rise time
<3.5 ns
Connection type
Leaded components

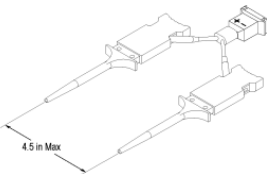

Use the MicroCKT test tips to access dense circuitry and IC leads spaced down to 10 mil-centers.

Y-Lead Adapter

Reorder: 196-3434-XX

Usable bandwidth
<100 MHz
Typical rise time
<3.5 ns
Connection type
0.025" Square Pin

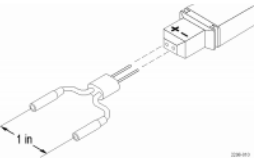

Use the Y-lead adapter to extend the reach of the probe and to connect to 0.025 inch square pins spaced as far as 1.5 inches apart. Use with Square pin adapter.

Longhorn Adapter

Reorder: 016-1884-XX

Usable bandwidth
<1.5 GHz
Typical rise time
<233 ps
Tip spacing
10 mils to .35 Inches
Connection type
PCB, Vias, & ICs

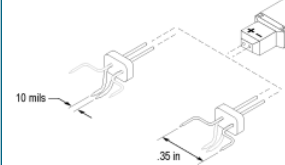

IC Micro-Grabber

Reorder: SMK4

Usable bandwidth
<100 MHz
Typical rise time
<3.5 ns
Connection type
Leaded components

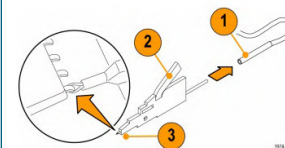

Use the IC Micro-Grabber to probe the leads on integrated circuits that are surface-mounted.

1" Solder Down Adapter

Resistor Kit: 020-2506-XX

Usable bandwidth
>1 GHz
Typical rise time
<233 ps
Tip spacing
10 mils to .35 Inches
Connection type
0.025" Square Pin

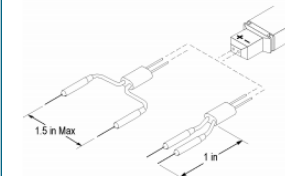

3" Solder Down Adapter

Resistor Kit: 196-3505-xx

Usable bandwidth
<600 MHz
Typical rise time
<265 ps
Tip spacing
10 mils to .35 Inches
Connection type
Solder in

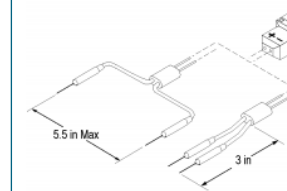

3" Ground Lead

Reorder: 196-3465-XX

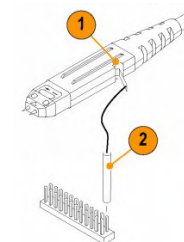

Color Bands

Reorder: 196-3465-XX



Differential Probes - Low Voltage - TDP3500 & TDP4000 Accessories



Variable Spacing Adapter

Reorder: 016-1885-XX

Usable bandwidth
Up to 4 GHz

Typical rise time
<110 ps

Tip spacing
.020 to .180 inches

Connection type
PCB, Vias, & ICs

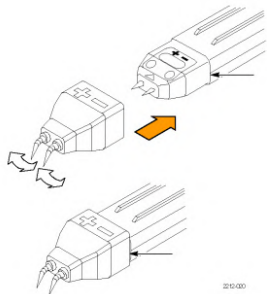

TwinFoot™ Adapter

Reorder: 016-1785-XX

Connection type
SMT components

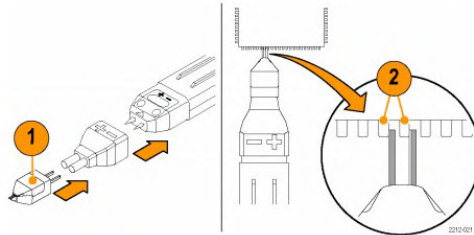

Use the TwinFoot adapter to probe two adjacent leads on a surface-mount integrated circuit. Use with Solder-in Adapter.

Square Pin Adapter

Reorder: 016-1884-XX

Usable bandwidth
<3.5 GHz

Typical rise time
<120 ps

Connection type
.025" Square Pin

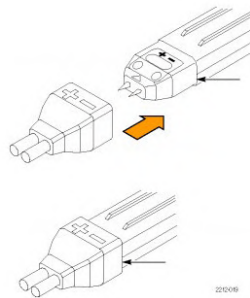

Use the square pin adapter to connect the probe to other accessories, such as the Y-lead adapter.

Y-Lead Adapter

Reorder: 196-3434-XX

Usable bandwidth
<100 MHz

Typical rise time
<3.5 ns

Connection type
0.025" Square Pin

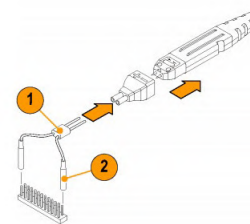

Use the Y-lead adapter to extend the reach of the probe and to connect to 0.025 inch square pins spaced as far as 1.5 inches apart. Use with Square pin adapter.

IC Micro-Grabber

Reorder: SMK4

Usable bandwidth
<100 MHz

Typical rise time
<3.5 ns

Connection type
Leaded components

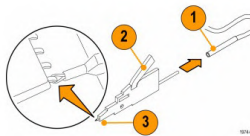

Use the IC Micro-Grabber to probe the leads on integrated circuits that are surface-mounted.

MicroCKT Test Tip

Reorder: 206-0569-XX

Usable bandwidth: <100 MHz

Typical rise time: <3.5 ns

Connection type: Leaded components

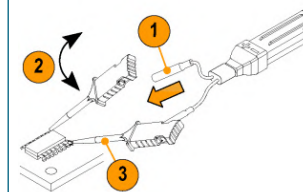

Use the MicroCKT test tips to access dense circuitry and IC leads spaced down to 10 mil-centers.

Solder in Adapter + Resistor Kit

Solder in Kit: 020-2505-XX

Solder in adapter: 016-1296-XX

Resistor Kit: 020-2506-XX

Usable bandwidth: Up to 4.3 GHz

Typical rise time: Down to 124 ps

Connection type: Solder in

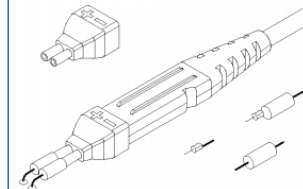

Use the solder-in adapter with the resistors and wires in the kit to create soldered test points to your circuit.

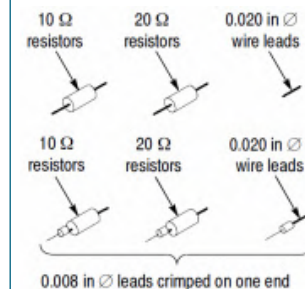

0.008 in \varnothing leads crimped on one end

3" Ground Lead

Reorder: 196-3465-XX

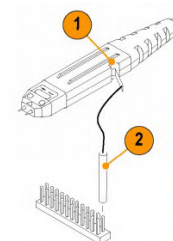

Color Bands

Reorder: 196-3465-XX



TriMode™ Probes - Low Voltage Differential & Single-ended

TriMode™ architecture streamlines measurement acquisition by enabling you to make differential, single-ended, and common mode measurements with a single connection.



P7600



P7700



TDP7700

Model	Bandwidth	Attenuation	Input Impedance	Differential Input Voltage	Operating Window	Offset Range	Interface
P7633	33 GHz	.25X -20X	50 Ω / 225 Ω	2 V, 10 V	±4, ±5	±4	TekConnect
P7625	25 GHz	.25X -20X	50 Ω / 225 Ω	2 V, 10 V	±4, ±5	±4	TekConnect
P7720	20 GHz		See TekFlex Accessory Performance Table				TekConnect
P7716	16 GHz		See TekFlex Accessory Performance Table				TekConnect
P7713	13 GHz		See TekFlex Accessory Performance Table				TekConnect
P7708	8 GHz		See TekFlex Accessory Performance Table				TekConnect
TDP7708	8 GHz		See TekFlex Accessory Performance Table				Flex Channel
TDP7706	6 GHz		See TekFlex Accessory Performance Table				Flex Channel
TDP7704	4 GHz		See TekFlex Accessory Performance Table				Flex Channel

TekFlex Accessory Table

TekFlex Accessory	Attenuation	Input Impedance	Differential Input Voltage	Operating Window	Offset Range
P77STFLXA P77STFLXB P77STCABL STFLRA STFLRB HTFLRA HTFLRB	4X	100kΩ 0.4 pF	5 V	±5.25V	±4V
P77BRWSR	10X	150 kΩ 22 pF	12 V	±10 V	±10 V
P77C292MM	Variable	50 Ω (SMA)	2 V	±4 V	±4 V

LEARN
MORE 

TriMode Probes – Low Voltage Differential & Single-ended – P7500 Accessories



DC Calibration Fixture

Use this fixture to calibrate your probes' DC accuracy when making critical measurements.

G3PO/SMPM Bullet Removal Tool



G3PO/SMPM Bullet Replacement Kit



RF Connector Maintenance

High performance RF connectors can often be fragile. Use these accessories to perform regular maintenance checks on your high performance probe to make sure you are getting the best signal integrity.

High Temp & High Density



Damped Wire Tip

Order #: 020-2959-XX, Kit of 25 Low cost solder tip. Not TriMode capable. Used with the 020-2954-00 Socket Cable. Up to 8 GHz bandwidth.

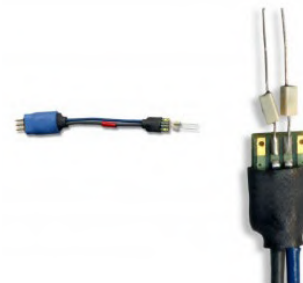

TriMode™ Micro-Coax Tip

Order #: 020-2955-XX, Kit of 10 Quick connect solder tip. Used with the 020-2954-XX Socket Cable. Up to 4 GHz bandwidth.

Mid-bus Probing



TriMode™ Resistor Solder Tip

Order #: 020-2936-XX, Kit of 1 High performance solder tip. Easy to solder tip resistors. Up to 18 GHz bandwidth.

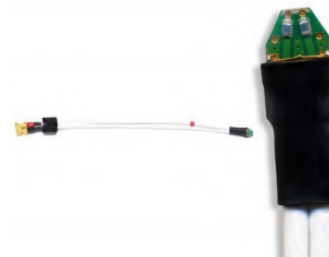

TriMode™ Long Reach Solder Tip

Order #: P75TLRST, Kit of 1 High performance solder tip. Up to 20 GHz bandwidth.



TriMode™ Performance Solder Tip

Order #: P75PST, Kit of 1 High performance solder tip. Up to 25 GHz bandwidth.

P75PST

TriMode Probes – Low Voltage Differential & Single-ended – P7600 Accessories



DC Calibration Fixture

Use this fixture to calibrate your probes' DC accuracy when making critical measurements.

G3P0/SMPM Bullet Removal Tool



G3P0/SMPM Bullet Replacement Kit



RF Connector Maintenance

High performance RF connectors can often be fragile. Use these accessories to perform regular maintenance checks on your high performance probe to make sure you are getting the best signal integrity.

P76CA-292C



33 GHz Bandwidth Coaxial Adapter with 2.92 mm (Male) connectors and 6" of high performance cable. This adapter is calibrated at the input connectors and is ideal for directly connecting to devices with 2.92 mm or SMA output connectors.

P76CA-SMP



33 GHz Bandwidth Coaxial Adapter with SMP (Female) connectors and 6" of high performance cable. This adapter is calibrated at the input connectors and is ideal for directly connecting to devices with SMP output connectors.

P76TA



30 GHz Bandwidth P7500 Tip Adapter. The probe and oscilloscope system will support up to 30 GHz of bandwidth when this adapter is used with the P75PST Performance Solder Tip.

P76CA-292



33 GHz Bandwidth Coaxial Adapter with 2.92 mm (Female) connectors. This adapter is calibrated at the input connectors and is ideal for use with off the shelf or custom cables. Low skew cable pairs should be used to preserve full bandwidth performance.

P75PST



High performance solder tip

Unique probe filters

The P7600 Series probes contain probe specific S-parameter data. Attaching a P7600 probe to a MSO/DP070000DX or DP070000SX oscilloscope transfers this data to the instrument to create unique system DSP filters based on the specific S-parameter data of the oscilloscope and the probe. Creating unique filters based on the specific response of the system is critical as bandwidths increase. At bandwidths of 33 GHz, small variations in the signal path can lead to significant variation in frequency response. These variations are corrected using DSP filtering.

TriMode Probes – Low Voltage Differential & Single-ended – P7700 & TDP7700 TekFlex™ Accessories



TekFlex connector technology

The P7700 & TDP7700 Series TriMode probes use the TekFlex connector technology that combines a high-speed signal path with power and communication support for an active buffer tip in a single, easy to attach accessory connector. The TekFlex connector has a pinch-to-open design that when open requires minimal force to attach an accessory tip. When the TekFlex connector is closed, it provides a secure connection to the accessory to avoid accidental disconnections.

P77BRWSR



16 GHz handheld browser accessory enables hand or fixture probing with adjustable tip spacing. The browser's tips are adjustable in spacing using a convenient thumb wheel. A headlight on the tip enhances visibility of the probe point and can be switched on and off as needed.

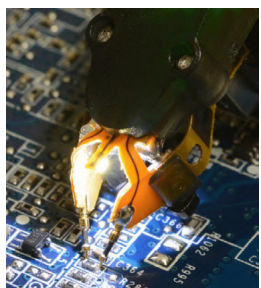

The browser tips are constructed of high strength BeCu and super-ceramic resistors. Each pin has integrated pogo springs and a crown cut tip to help make solid mechanical connections to components and traces.



Probe Stand and wand accessories for both hands free and hands on browsing give you flexibility when you are debugging your circuit.



DC Calibration Fixture

Order #: 067-4889-xx

Use this fixture to calibrate your probes DC accuracy when making critical measurements. For P7700 probes.



Probe Deskew Fixture

Order #: P77DESKEW

Use this fixture to time align your TekFlex probes for the best timing accuracy to make critical timing measurements.

P77C292MM



SMA/2.92mm adapter for connecting to coaxial connectors RF/coaxial connectors, such as SMA, are often found on test fixtures or on prototype board designs. Attaching a P7700 or TDP7700 series probe to these on-board connectors is easy with the SMA adapter.

DISPLAYPORT TYPE-C TRANSMITTER TESTING SETUP

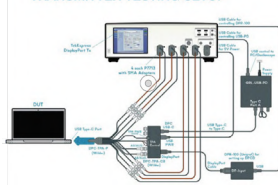

The P77C292MM adapter includes TriMode functionality enabling differential, single ended, and common mode measurements. Include variable termination voltage that can be set manually or automatically using voltage sense circuitry in the P7700 or TDP7700 probes over a range of ± 4 V for testing display technologies like HDMI and Display Port.

P77STCABL



20 GHz solder down accessory with a long reach, flexible cable combined with an active buffer amplifier on the tip. The long tip reach make it great for escaping tight board geometries while maintaining electrical performance.

P77STFLXA



- 20 GHz solder-down flex-circuit probe tip with an active buffer amplifier located at the tip.
- Each tip includes factory-stored AC calibration data.
- The oscilloscope automatically de-embeds this calibration when the tip is connected.

P77STFLXB



- 16 GHz solder-down, long-reach flex-circuit probe tip designed for DDR and LPDDR electrical validation when used with Nexus XH-series interposers.
- Long-reach, flexible construction improves access to difficult or obstructed test points.
- Each tip includes factory-stored AC calibration data.
- The oscilloscope automatically de-embeds both the calibration and the nominal XH-series interposer response when connected.

P77STFLRB / P77HTFLRB



- 16 GHz solder-down, long-reach flex-circuit probe tip designed for DDR and LPDDR electrical validation when used with Nexus XH-series interposers.
- Long-reach, flexible construction improves access to difficult or obstructed test points.
- Each tip includes factory-stored AC calibration data.
- The oscilloscope automatically de-embeds both the calibration and the nominal XH-series interposer response when connected.

P77STFLRA / P77HTFLRA



- 20 GHz solder-down, long-reach flex-circuit probe tip with an active buffer amplifier located at the tip.
- Long-reach, highly flexible design improves access to hard-to-reach or obstructed test points.
- Each tip includes factory-stored AC calibration data.
- The oscilloscope automatically de-embeds this calibration when the tip is connected.

Current Probes

Tektronix current probe solutions offer:

- The broadest range of AC/DC and AC-only current probes
- Measurement accuracy from μ As to 2000 A
- Best-in-class bandwidth up to 120 MHz
- Best-in-class current clamp sensitivity down to 1 mA
- The only products with 3rd Party Safety Certification (UL, CSA, ETL)
- The only products with bare wire voltage ratings
- Automatic readout and scaling when used with Tektronix oscilloscopes so you don't have to convert volts to amps or manually set the scaling

DC/AC

Model	Maximum Current	Minimum Current*	Bandwidth	Rise Time	Interface
TCPA300	Current Probe Amplifier				TekProbe LVL 2
TCP312A	30 A DC; 21.2 A _{RMS} ; 50 A peak	1 mA	DC - 100 MHz	≤ 3.5 ns	Amplifier
TCP305A	50 A DC; 35.4 A _{RMS} ; 50A peak	5 mA	DC - 50 MHz	≤ 7 ns	Amplifier
TCP303	150 A DC; 150 A _{RMS} ; 500A peak	5 mA	DC - 15 MHz	≤ 23 ns	Amplifier
TCPA400	Current Probe Amplifier				TekProbe LVL 2
TCP404XL	500 A DC; 500 A _{RMS} ; 750 A peak	1 A	DC - 2 MHz	≤ 175 ns	Amplifier
TCP0030A	30 A DC; 30 A _{RMS} ; 50 A peak	1 mA	DC - 120 MHz	≤ 2.92 ns	TekVPI
TCP0020	20 A DC; 20 A _{RMS} ; 100 A peak	10 mA	DC - 50 MHz	≤ 7 ns	TekVPI
TCP2020	20 A DC; 20 A _{RMS} ; 100 A peak	10 mA	DC - 50 MHz	≤ 7 ns	BNC
TCP0150	150 A DC; 150 A _{RMS} ; 500 A peak	5 mA	DC - 20 MHz	≤ 17.5 ns	TekVPI
A622	100 A DC; 70.7 A _{RMS} ; 100 A peak		DC - 100 kHz	≤ 3.5 μ s	BNC

*Winding the conductor multiple times through the current probe jaws increases the sensitivity.

LEARN
MORE 



TCP0030A



TCPA300



TCP312A



TCP303



A622

Current Probes CONTINUED

AC Only



P6021A

Model	Maximum Current	Minimum Current	Sensitivity*	Bandwidth	Interface
P6021A	10.6 A _{RMS} ; 250 A peak		2 mA/mV, 10 mA/mV	120 Hz - 60 MHz	TekProbe
P6022	4 A _{RMS} ; 100 A peak		1 mA/mV, 10 mA/mV	935 Hz - 120 MHz	BNC
TRCP3000	3000 A peak	500 mA	2 mV/A	1 Hz - 16 MHz	BNC
TRCP0600	600 A peak	500 mA	10 mV/A	12 Hz - 30 MHz	BNC
TRCP0300	300 A peak	250 mA	20 mV/A	9 Hz - 30 MHz	BNC
CT1	450 mA _{RMS} ; 12 A peak		5 mV/mA	25 kHz - 1 GHz	BNC
CT2	2.5 A _{RMS} ; 36 A peak		1 mV/mA	1.2 kHz - 200 MHz	BNC
CT6	120 mA _{RMS} ; 6 A peak		5 mV/mA	250 kHz - 2 GHz	BNC
A621	1000 A _{RMS} ; 2000 A peak	100 mA	1 mV/A	5 kHz - 50 kHz	BNC

*Winding the conductor multiple times through the current probe jaws increases the sensitivity.

LEARN
MORE 



TRCP3000



CT1



CT6



A621

High Voltage Probes - Single-ended

A high voltage single-ended probe is typically used for measuring ground referenced signals up to 40 kV. However, some single-ended probes are designed for instruments with isolated or floating inputs for measurements that are not ground referenced. Users should select probes with a low input capacitance specification (< 4 pF) to minimize the probe's loading effect on the circuit because a probe with lower input capacitance will offer higher input impedance at higher frequencies.

Tektronix High Voltage Probe solutions offer:

- Best-in-class bandwidth up to 800 MHz
- Best-in-class probe loading with input capacitance as low as 1.8 pF
- The only products with 3rd Party Safety Certification (UL, CSA, ETL)
- Most extensive set of probe accessories

Model	Bandwidth	Max Voltage	Attenuation	Input Impedance	Compensation Range	Interface
P5100A	500 MHz	1000 V _{RMS} (CAT II) 2.5kV peak	100X	40 MΩ 2.5 pF	7 pF -30 pF	TekProbe LEVEL 1
P6015A	75 MHz	20 kV _{RMS} 40 kV peak	1000X	100 MΩ ≤ 3 pF	7 pF -49 pF	TekProbe L1 or BNC
P5122	200 MHz	1000 V _{RMS} (CAT II)	100X	100 MΩ 4.6 pF	10 pF -25 pF	BNC
TPP0850	800 MHz	1000 V _{RMS} (CAT II) 2.5kV peak	50X	40 MΩ 1.8 pF	Auto compensated by scope	TekVPI

LEARN MORE 



P6015A



P5100A



TPP0850

Differential Probes – High Voltage

A high voltage differential probe is used for measuring the voltage difference between two test points where neither test point is at ground. High voltage differential probes from Tektronix can be used for signals up to 6000 V. These probes are the best choice for making non-ground referenced, floating or isolated measurements in large part due to their common mode rejection capability. These products are designed, manufactured, and serviced by Tektronix.

Tektronix High Voltage Differential Probe solutions offer:

- Best-in-class bandwidth and probe loading
- The only products with 3rd Party Safety Certification (UL, CSA, ETL)
- High and medium voltage products to support varying dynamic range and measurement resolution requirements
- Most extensive set of probe accessories



THDP0100







P5200A



THDP0200/TMDP0200

Model	Bandwidth	Rise Time	Attenuation	Maximum Differential Voltage	Maximum Voltage to Earth Ground	Differential Input Capacitance	Single Ended Input Capacitance	Differential Input Resistance	Single Ended Input Resistance	Cable Length (T _{propagation})	Interface
P5200A	50 MHz	7.8 ns	50:1 / 500:1	±1300 V	1000 Vrms (CAT II)	2 pF	4 pF	10 MΩ	5 MΩ	1.5 m (21 ns)	BNC (1 MΩ)
P5202A	100 MHz	3.8 ns	20:1 / 200:1	±640 V	300 Vrms (CAT II)	2 pF	4 pF	5 MΩ	2.5 MΩ	1.5 m (21 ns)	TekProbe LVL 2 (1 MΩ)
P5205A	100 MHz	3.8 ns	50:1 / 500:1	±1300 V	1000 Vrms (CAT II)	2 pF	4 pF	10 MΩ	5 MΩ	1.5 m (21 ns)	TekProbe LVL 2 (1 MΩ)
P5210A	50 MHz	7.8 ns	100:1 / 1000:1	±5600 V	2300 Vrms (CAT I)	2.5 pF	5 pF	40 MΩ	20 MΩ	1.5 m (21 ns)	TekProbe LVL 2 (1 MΩ)
TMDP0200	200 MHz	1.8 ns	25:1 / 250:1	±750 V	550 Vrms (CAT I)	2 pF	4 pF	5 MΩ	2.5 MΩ	1.5 m (21 ns)	VPI (1 MΩ)
THDP0200	200 MHz	1.8 ns	50:1 / 500:1	±1500 V	1000 Vrms (CAT II)	2 pF	4 pF	10 MΩ	5 MΩ	1.5 m (21 ns)	VPI (1 MΩ)
THDP0400	400 MHz	0.9 ns	50:1 / 100:1 / 250:1 / 500:1	±2000 V	±2000 Vpk (1000 V CAT III)	2.5 pF	5 pF	10 MΩ	5 MΩ	2 m (13 ns)	VPI (1 MΩ)
THDP0100	100 MHz	3.5 ns	100:1 / 1000:1	±6000 V	2300 Vrms (CAT I)	2.5 pF	5 pF	40 MΩ	20 MΩ	1.5 m (21 ns)	VPI (1 MΩ)

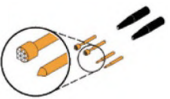
Differential Probes – High Voltage Accessories

Accessory	Description	P5205A	P5200A/P5205A	THDP0100/P5210A	TMDP0200	THDP0200
AC280-FL 	Hook Clip X2	450 Vrms CAT I 300 Vrms CAT II	1000 Vrms CAT II 600 Vrms CAT III	1000 Vrms CAT I 1000 Vrms CAT III	550 Vrms CAT I 300 Vrms CAT III	1000 Vrms CAT II 600 Vrms CAT III
		STANDARD	STANDARD	OPTIONAL	STANDARD	STANDARD
AC283-FL 	Micro Grabber Tip X2	450 Vrms CAT I 300 Vrms CAT II	1000 Vrms CAT II 600 Vrms CAT III	1000 Vrms CAT I 1000 Vrms CAT III	550 Vrms CAT I 300 Vrms CAT III	1000 Vrms CAT II 600 Vrms CAT III
		STANDARD	STANDARD	OPTIONAL	STANDARD	STANDARD
AC285-FL 	Alligator Clip (large) X2	450 Vrms CAT I 300 Vrms CAT II	1000 Vrms CAT II 600 Vrms CAT III	1000 Vrms CAT I 1000 Vrms CAT III	550 Vrms CAT I 300 Vrms CAT II	1000 Vrms CAT II 600 Vrms CAT III
		STANDARD	STANDARD	OPTIONAL	STANDARD	STANDARD
020-3107-00 	Pogo Pin Adapter Kit X2	150 Vrms CAT II	150 Vrms CAT II	150 Vrms CAT II	150 Vrms CAT II	150 Vrms CAT II
		OPTIONAL	OPTIONAL	OPTIONAL	STANDARD	STANDARD
012-1724-00 	Test Probe Extension (fine point) Adapter X2	300 Vrms CAT I 300 Vrms CAT II	300 Vrms CAT II	300 Vrms CAT I 300 Vrms CAT II	300 Vrms CAT I 300 Vrms CAT II	300 Vrms CAT II
		OPTIONAL	OPTIONAL	OPTIONAL	STANDARD	STANDARD
344-0670-00 	Alligator Clip (small) X2	450 Vrms CAT I 300 Vrms CAT II	1000 Vrms CAT II 600 Vrms CAT III	THDP010: 300 Vrms CAT I P5210A: 1000 Vrms CAT I 1000 Vrms CAT III	300 Vrms CAT I	300 Vrms CAT I
		OPTIONAL	OPTIONAL	OPTIONAL	STANDARD	STANDARD

IsoVu™ Isolated Voltage Probes

IsoVu™ probes are the right tool for today's demanding power measurement challenges given their industry leading 1 GHz bandwidth, 160 dB or 100 Million to 1 common mode rejection, 60 kV common mode voltage, large ± 3300 V differential range and superior probe loading.

Optimize for Performance and Efficiency

The benefits of a power design can only be realized when the switching circuit, the gate drive circuit, and the layout are all properly designed and optimized. IsoVu can be used to:

- Characterize the gate drivers, V_{gs} , V_{ds} , and I_s
- Characterize the time alignment of high and low side events
- Optimize and tune the switching characteristics

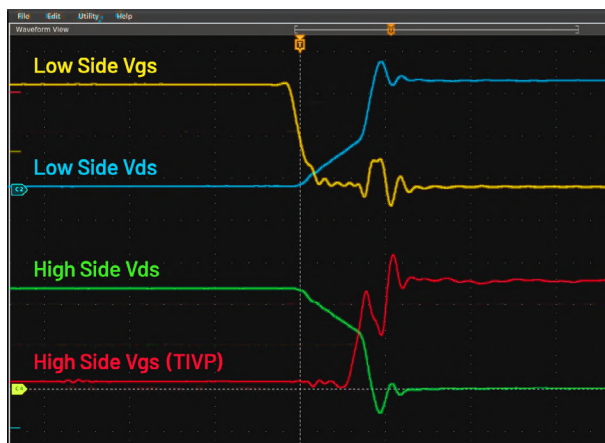

Model	Bandwidth	Rise Time	Cable Length	Maximum Differential Input Voltage	Maximum Offset range	Maximum Common Mode Voltage to Earth	Interface
TIVP02	200 MHz	2 ns	2 m	3300 V**	± 2500 V**	60 kV	VPI(4/5/6 Series)
TIVP02L	200 MHz	2 ns	10 m	3300 V**	± 2500 V**	60 kV	VPI(4/5/6 Series)
TIVP05	500 MHz	850 ps	2 m	3300 V**	± 2500 V**	60 kV	VPI(4/5/6 Series)
TIVP05L	500 MHz	850 ps	10 m	3300 V**	± 2500 V**	60 kV	VPI(4/5/6 Series)
TIVP1	1 GHz	450 ps	2 m	3300 V**	± 2500 V**	60 kV	VPI(4/5/6 Series)
TIVP1L	1 GHz	450 ps	10 m	3300 V**	± 2500 V**	60 kV	VPI(4/5/6 Series)



LEARN
MORE



IsoVu™ Isolated Voltage Probe Accessories

TIVM Tip Model	Attenuation	Differential Voltage	Offset Range	Input Impedance	Max Non-Destruct Voltage Vpk (DC + peak AC) ¹	CMRR						Standard Attachment
						DC - 1 MHz	1 MHz	100 MHz	200 MHz	500 MHz	1 GHz	
SMA Input (50 Ω Mode)	1:1	±5 V	±25 V	50 Ω N.A.	5 V RMS	160 dB	145 dB	100 dB	100 dB	100 dB	90 dB	
SMA Input (1 MΩ Mode)	1:1	±5 V	±25 V	1 MΩ 11 pF	100 Vpk	160 dB	145 dB	100 dB	100 dB	100 dB	90 dB	
TIVPMX10X	10:1	±50 V	±200 V	10 MΩ 2.8 pF	250 Vpk	160 dB	115 dB	92 dB	90 dB	85 dB	80 dB	Sensor Tip
TIVPMX50X	50:1	±250 V	±250 V	10 MΩ < 5 pF	300 Vpk	160 dB	104 dB	85 dB	80 dB	73 dB	70 dB	Sensor Tip
TIVPSQ100X	100:1	±500 V	±500 V	10 MΩ < 5 pF	600 Vpk	160 dB	100 dB	70 dB	57 dB	39 dB	30 dB	0.1" Square Pin
TIVPWS500X	500:1	±2.5 kV	±2.5 kV	40 MΩ < 4 pF	3300 Vpk	160 dB	100 dB	60 dB	48 dB	33 dB	25 dB	0.1" Wide Square Pin
TIVPMX1X	1:1	±5 V	±25 V	50 Ω or 1 MΩ 11 pF	5 V RMS (50 Ω) 100 Vpk (1 MΩ)	160 dB	145 dB	100 dB	100 dB	100 dB	90 dB	Sensor Tip

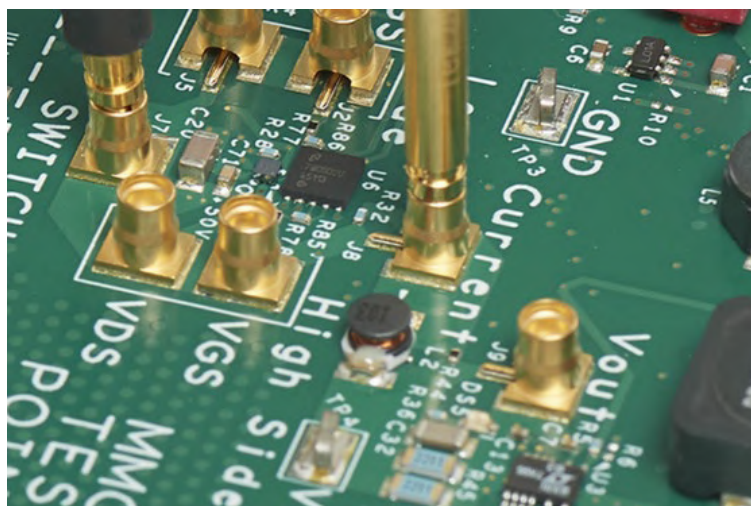

IsoVu™ Isolated Current Probes

Make more accurate dynamic shunt-based current measurements with TICP Series Current Probes. High bandwidth, flexible ranges, complete galvanic isolation and extremely low noise enable you to go beyond traditional limits – ideal for low noise measurements on current shunts in floating sections of power circuits.

- Measurements from DC to hundreds of MHz when paired with high-performance shunts or CVRs.
- Complete RF isolation between the probe tip and the scope eliminates ground loops and dramatically reduces common mode noise.
- Low attenuation, 50 ohm input impedance, and shielded tips ensure a low noise contribution.

Model	Bandwidth	Differential Voltage	Common Mode Voltage	Common Mode Rejection Ratio
TICP025	250 MHz	±0.5V (1X Tip) ±5V (10X Tip) ±50V (100X Tip)	1800 V Pollution Degree 1 1000 V CAT II	140 dB at DC up to 90 dB at 1 MHz
TICP050	500 MHz	±0.5V (1X Tip) ±5V (10X Tip) ±50V (100X Tip)	1800 V Pollution Degree 1 1000 V CAT II	140 dB at DC up to 90 dB at 1 MHz
TICP100	1 GHz	±0.5V (1X Tip) ±5V (10X Tip) ±50V (100X Tip)	1800 V Pollution Degree 1 1000 V CAT II	140 dB at DC up to 90 dB at 1 MHz

LEARN
MORE

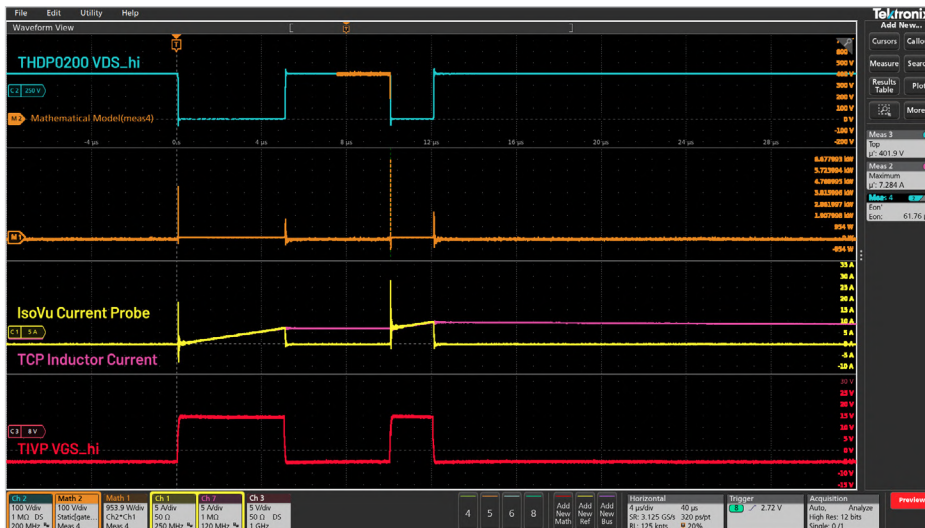

IsoVu Current probe clearly shows the ringing.

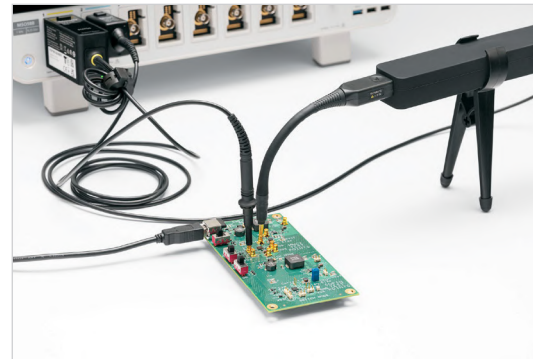

TICP100

Wideband Shunts for IsoVu™ Isolated Current Probes

Shunt Specifications	5 mΩ	50 mΩ	500 mΩ	5 Ω
Nomenclature	TICS0005	TICS0050	TICS0500	TICS5000
Bandwidth	120 MHz	250 MHz	250 MHz	250 MHz
Rise Time	TBD	1.2 ns	1.2 ns	1.3 ns
Noise Floor (A RMS) at full bandwidth	13 mA	1.5 mA	150 μA	15 μA
Maximum Pulse Current (A)	130 A	13 A	1.3 A	130 mA
Shunt Insertion Deduction	6 nH–7 nH for square pins and TICS 2 nH–3 nH for square pins and jumper alone			
Probe Tip/Shunt Temperature Range	–40 °C to +85 °C			

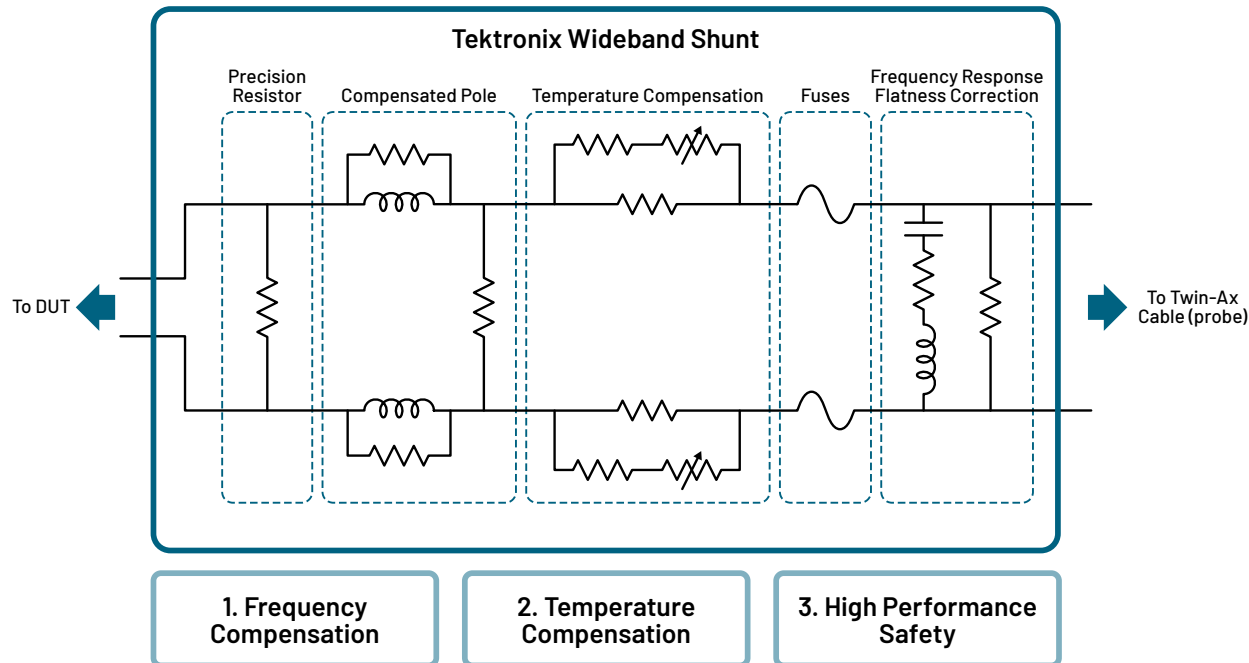
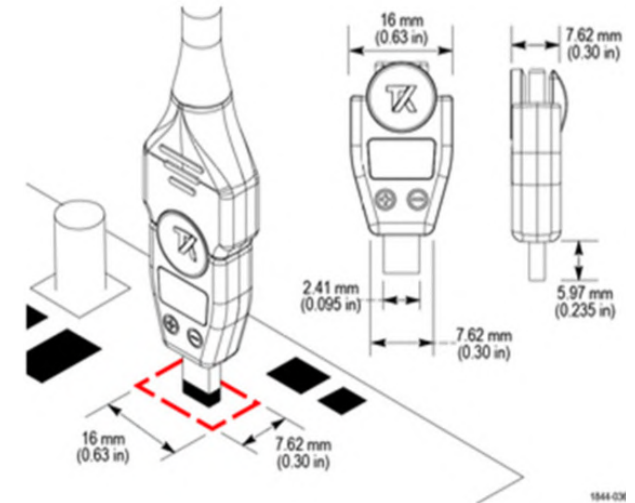

TICS5000, TICS0500, TICS0050, TICS0005



TICPTWCBL required for Measurements on Wideband Shunts with TICP

IsoVu™ Isolated Current Probes Accessories



TICPMM100
100X Sensor Tip Cable with MMCX Connector



174-7496-xx
MMCX to Square Pin Socket Adapter



174-7494-xx
Twisted pair solder-in accessory



196-3546-xx
MMCX to IC Grabber Lead



196-3547-xx
Square Pin to IC Grabber Lead



131-9677-xx
Square Pin to MMCX Adapter,
0.062" Spacing



206-0589-xx
MicroCKT Grabbers

Optical Probes

High Bandwidth

Model	Electrical	Bandwidth (-3 dB)	Wavelength Range Opt. FC/PC	Input Fiber	Oscilloscope Interface	Rise Time (10% to 90%)	Optical Noise	Maximum Input Power (Linear Response)
DP070E1	33 GHz	750 nm to 1650 nm Calibrated at 850 nm, 1310 nm, 1550 nm	FC/PC: 50 μ m SMF and MMF compatible	FC/APC: 9 μ m SMF compatible	ATI (1.85 mm RF connector) and TekConnect	10.2 ps, typical	6.6 μ W rms (TekConnect / ATI)	4 mW, typical
DP070E2	59 GHz	1200 nm to 1650 nm Calibrated at 1310 nm, 1550 nm	FC/PC: 9 μ m SMF compatible	FC/APC: 9 μ m SMF compatible	ATI (1.85 mm RF connector) and TekConnect	7.5 ps, typical	10 μ W rm (ATI)	2 mW, typical

The DP070E Series Optical Probes paired with a DP070000 real time oscilloscope delivers high performance and advanced debug capabilities that are necessary for designers to fully troubleshoot 400G PAM4 signals (up to 56 GBd) and reduce time to market needs. These probes can also be used as a conventional O/E with a flat frequency response for general signal acquisition up to their respective bandwidth: 33 GHz using the DP070E1 or 59 GHz using the DP070E2.

- Versatile and modular design for use with multiple high-performance real time oscilloscope models
- Broad wavelength range with FC/PC and FC/APC connector options
- Deep optical PAM4 and PAM2 (NRZ) signal analysis and error detection
- User selectable Optical Reference Receivers (ORR)

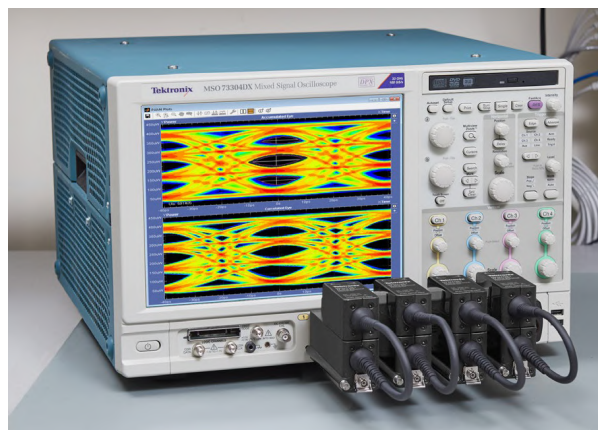

DP070E Series Optical probes using the TekConnect channel on a MSO73304DX Oscilloscope



DP070E Series Optical probes using the TekConnect channel on a DP07002SX ATI Performance Oscilloscope.

LEARN
MORE

Logic Probes

Model	Threshold Voltage	Threshold Accuracy	Max Input Signal Swing	Input Resistance	Input Capacitance	Min Detectable Input Pulse	Input Channels	Compatible With
P6316	±20 V	±100 mV + 3% threshold setting	±20 V	101 kΩ	8 pF	5 ns	16	MDO3000 MSO / DPO2000 MSO / DPO3000
TLP058	±40 V	±100 mV + 3% threshold setting	30 Vpp ≤ 200 MHz 10 Vpp >200 MHz	100 kΩ	2 pF	1 ns	8	4 Series MSO 5 Series MSO 6 Series MSO
P6717A	±15 V	±100 mV + 3% threshold setting	±15 V	20 kΩ	3 pF	500 ps	16	MSO / DPO70000DX

Logic probes are used to analyze the logic states of digital signals. To verify and debug high-speed, low-voltage signals you need logic probes that can accurately acquire signals from a wide variety of electronic designs while protecting signal fidelity.

Key specs:

- 6.25 GS/s max sample rate
- 5 ns digital to analog trigger skew
- 500 MHz max toggle rate
- 8-16 input channels



LEARN
MORE 

Oscilloscope Adapters

TCA-VPI50A



TekConnect-to-TekVPI adapter for 50 Ω TekVPI compatible probes

TCA-BNC



A TekConnect-to-TekProbe BNC adapter for 50 Ω TekProbe-compatible probes

TCA-1MEG



A TekConnect-to-TekProbe BNC high-impedance buffer amplifier providing a 1 M Ω /10 pF input

TCA-292MM



A TekConnect-to-2.92 mm SMA compatible adapter with a 50 Ω input

TCA292D



A TekConnect-to-2.92 mm adapter for 2.92 mm or SMA-terminated devices

TCA-SMA



A TekConnect-to-SMA adapter that provides a direct 50 Ω SMA input

TCA75



A TekConnect-to-75 Ω BNC adapter for 75 Ω terminated circuitry

TCA-N



A TekConnect-to-N adapter providing a direct 50 Ω N-type input

TPA-BNC



A TekVPI-to-TekProbe BNC adapter for 50 Ω TekProbe-compatible probes

TPA-20MHz



A TekVPI 20 MHz signal path low-pass hardware filter

TPA-N-VPI



An N-to-TekVPI adapter for connecting 50 Ω TekVPI probes to the oscilloscope's N-type input

TPA-N-PRE



An N-to-SMA preamplifier featuring 12 dB gain from 9 kHz to 6 GHz



Mess- und Prüftechnik. Die Experten.

**Ihr Ansprechpartner /
Your Partner:**

dataTec AG
E-Mail: info@datatec.eu
datatec.eu

Find more valuable resources at TEK.COM

