



EL+ vHF/DC ePlus

Avionics | Regenerative High Frequency Electronic Load



CINERGIA has developed a line of Regenerative Electronic Load products capable of working in a frequency range of 360 to 900Hz. It was designed to simulate the different loads that can be found in the aircraft.

The testing of aircraft generators with variable frequency is an added difficulty. Since the regulations require a constant value of $\cos \phi$, this implies the need to vary the magnitude of the inductance during the test. Through passive elements, the cost can be very high, and we obtain discrete results.



Mess- und Prüftechnik. Die Experten.

Ihr Ansprechpartner / Your Partner:

dataTec AG

E-Mail: info@datatec.eu

>>> www.datatec.eu

CINERGIA's electronics loads are the best tools for this type of tests. Their easy-to-use software allows us to control all the parameters and adjust the magnitude of the current required in the test. Its Bidirectional and Regenerative Hardware based on a back-to-back power conversion topology also allows energy and power saving.



Regenerative Technology

Thanks to our bi-directional topology, the AC/DC Electronic Load Converter are regenerative, resulting in a reduction of both the consumed energy during the tests and the power required from the electrical installation.

This technology allows us to work in both directions, as power generators or offering a consumption for the realization of all types of tests.

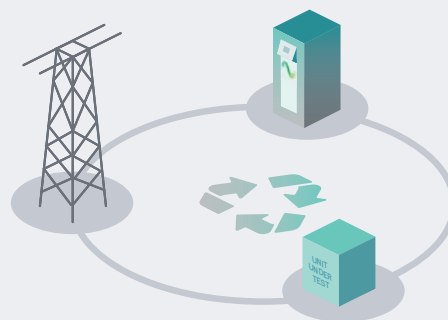

Bidirectional and Regenerative

Clean grid current

THDi <3% and PF > 0.98

5 Models

from 15kW to 50kW

Parallelization of units to increase the power

Independent phase configuration of

rms current, phase angle, generation of fast transients ("Current Dips")

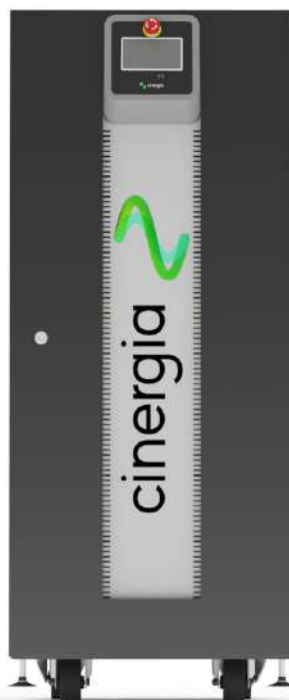

High Frequency range

360-900 Hz

Emulation of grid connected devices

Loads absorbing energy from grid
Generators injecting energy to the grid
Programmable Active/Reactive consumption
Non-linear currents up to CF of 3

Overload of 200% P_{rated}

Modbus/Ethernet Open protocol, Labview drivers

Bidirectional and Regenerative Hardware

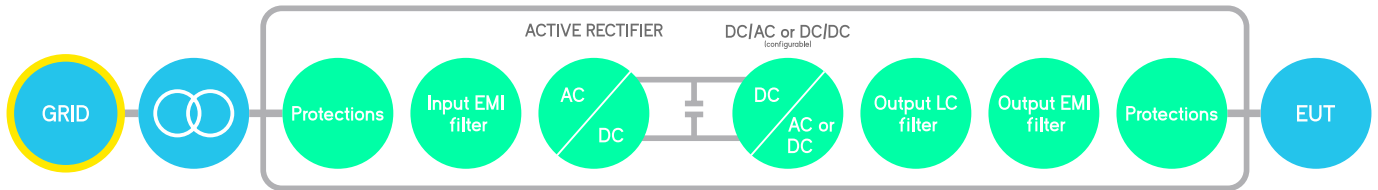

The hardware platform is based on a Back-to-Back power conversion topology, formed by two IGBT-based power stages. The grid side stage is an Active Rectifier which produces clean sinusoidal currents with very low harmonic distortion and power factor close to one.

The EUT side stage can be configured for AC voltage source or AC current source or DC output. In AC, voltage/current are controlled by using state of the art digital Proportional-Resonant controllers. In DC, the three independent buck-boost bidirectional legs enable the separated control of three different DC voltages or currents.

Block Diagram

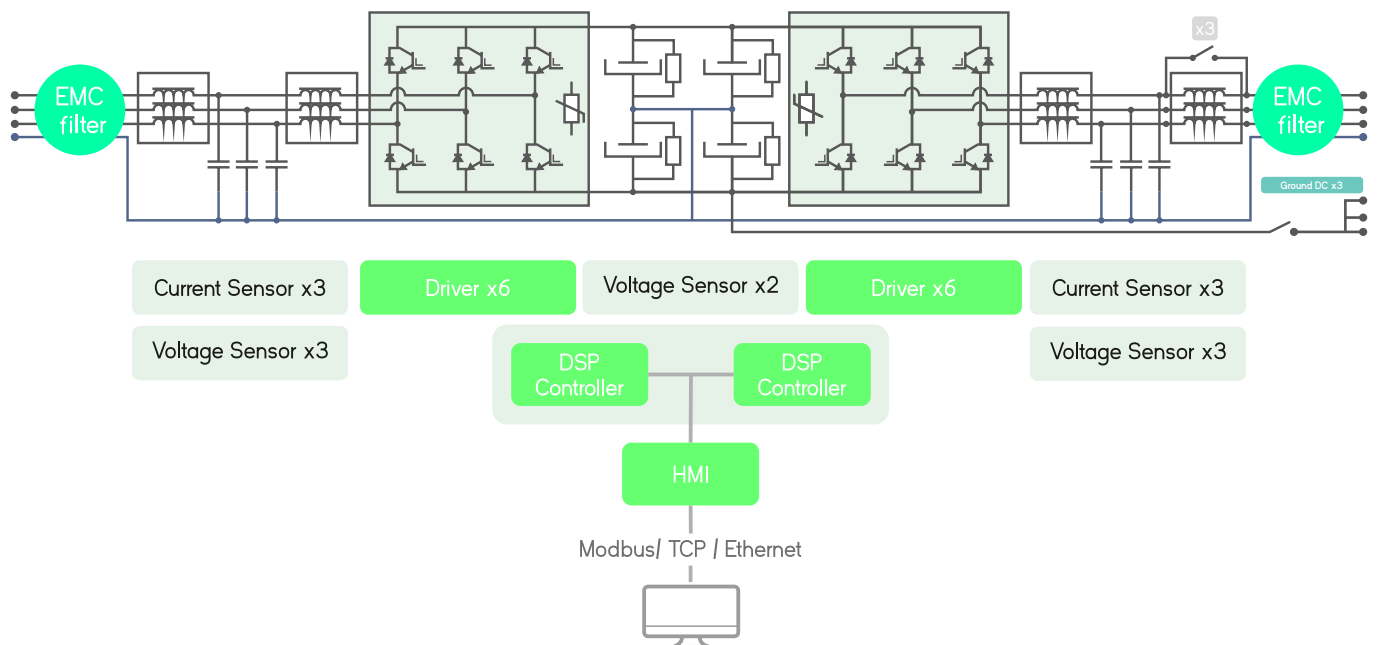

Local Interface

Analogue and Digital IO ports

The isolated digital and analogue inputs/outputs permit the connection of the unit to External Controllers and Power Hardware in the Loop systems (option).

4.3" Touchscreen

Allows the local parameterization and command of the device, configuration of the communications link, plots the main signals and enables the local datalogging.

Safety First

The units integrate a local Emergency Stop pushbutton and two signals (input+ output) to be connected to the laboratory interlock system. Additionally, the digital outputs can be interfaced to safety tower lights.

Master/Slave

ePLUS is a modular platform enabling the master/slave connection of units with equal power.



Better than ever, the enhanced **Plus** family



What's better

MASTER/SLAVE CONNECTION

by using a fiber optics link to increase power/voltage capabilities:

GE in AC: can be connected in parallel

EL in AC: can be connected in parallel

B2C: can be connected in parallel, or series or both

FASTER

30kHz control loop frequency

MORE HARMONICS

50 per phase with 20 free-harmonics

DELTA LOAD

for the EL in AC mode

ADJUSTABLE DC TRANSIENT

controllers to improve stability of the system

OPTIMIZED RMS CALCULATION

for PV inverters anti-islanding test

SAME ELECTRICAL RATINGS

and SAME BANDWIDTH

because the power platform does not change so robustness and ratings remain the same.



Software



The user interface used by CINERGIA devices has been developed by our R&D team, to offer total control of the device, with a comfortable and intuitive design. This allows us to take full advantage of the capabilities of the device, as well as the programming and execution of standardized or self-created tests.



EL Modes



AC Operation

From this panel, the user can set all AC parameters. Each phase can be independently configured: RMS current magnitude, phase delay, harmonics content, free-frequency harmonic and transition ramps. A plot shows the expected real-time waveform, the FFT representation and the numeric data: RMS, peak, CF and THD.



Harmonics

The device can control simultaneously the magnitude of the first 15 harmonics and one free harmonic per phase. The free one allows the generation of sub-harmonics, inter-harmonics and high frequency harmonics up to the 50th, setting both the magnitude and phase delay.

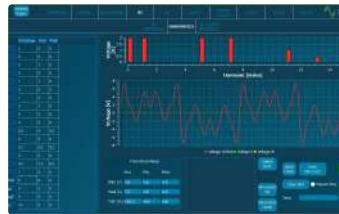

Power and Impedance Control

In Power mode, the active and reactive power of each phase is independently controlled. In Impedance mode, the device emulates an RLC load allowing to parameterize resistance, inductance and capacitance per phase making this device suitable for Anti-Islanding test of grid converters.



AC



Steps Mode

One of the most remarkable novelties of the new software is the steps functionality. Step test files are saved and executed by the DSP allowing deterministic timing with a resolution of 66µs. The user gains access to all registers of the device to create complex test sequences which run directly in the converter without the need of an external computer.



Disturbance Generation

The steps mode includes predefined easy-to-use test panels. The AC faults panel is a powerful yet intuitive editor which allows generating and configuring flicker. Specific profiles can be saved in .csv files, modified, and reused by importing an existing one.

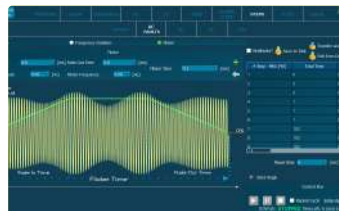

Linear & Non-Linear Emulation

The capacity to emulate linear and non-linear loads in one of the main features of the 4Q Electronic Load. Through our intuitive control software, the magnitude of harmonics can be set and different types of loads can be generated.



DC



DC Operation

This panel allows the user to access all DC setpoints and limits. Thanks to the unique Multichannel feature, each phase can have a different Operation Mode: voltage, current, power, resistance and advanced DC applications. Transition ramps, voltage and current limits can be modified. The limits for sink and source operation are different for safer testing, specially in battery applications.



Sequence

The User Interface Software integrates a Sequence Editor to create automatic test sequences, save them for future use and import them in .csv files. A smart datalogger can be activated from the LCD of the unit to record automatically the resulting voltage and current measurements with a time resolution of 400 ms.



Multichannel

Enabling the Separated Channel Control converts the device in three functionally independent DC Bidirectional Power Supplies, sharing the common negative rail. Each channel can have a different status (ON, OFF, Warning, Alarm), Operation Mode (see Range and Specifications table), Setpoint, Ramp and Limits.



Battery Pack Tester

This functionality enables the user to precisely control the charge, discharge and cycling of a Battery. Basic parameters include the charge/discharge current, fast charge and floating voltages while Advanced parameters add Energy (Ah) and Time as transition conditions. Profiles for each Battery technology can be saved and imported in .CSV files.



Battery Emulation

The B2C+ integrates a mathematical model to emulate the voltage behaviour of a real battery pack. The output voltage will change as a function of the SOC and Current. By configuring the provided parameters, the voltage profile can be adjusted to match different technologies: Lilon, NiMH, NiCd, Pb, Flux, etc.

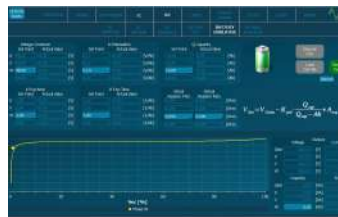

PV Panel Emulation

The PV Panel model is based on the single-diode equivalent circuit of a PV cell and the series-parallel connection of cells to form a panel. A Runtime functionality allows the simulation of a complete day by launching different irradiance and temperature setpoints from a .csv file, enabling the user burn-in and functional tests of PV Inverters.

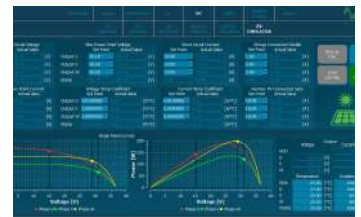

EL+ vHF/DC Range & Specifications

Input side (GRID side)

AC Voltage

Rated: $3 \times 400 \text{V}_{\text{rms}}$ +Neutral+ Earth
Range: +15% / -20% (-10% @ P_{rated})

Rated AC Current

Depends on model (see Wiring Manual)

Frequency

48-62Hz

Current Harmonic Distortion

THDi < 3% at rated power

Current Power Factor

PF > 0.98 at rated power

Efficiency

$\geq 89\%$ (7.5 & 10), $\geq 91\%$ (15 to 30), $\geq 92\%$ (40 to 200)

Output side in DC (EUT side)

Terminals

Number: 4 (3 phases + 1 neutral)

Configuration of Channels

Unipolar 3-channels 2Q, independent setpoints per channel

Unipolar 1-channel 2Q, one global setpoint for all channels

Multichannel: 2Q, independent start/stop, operation mode and setpoints
per channel (note: multichannel is an option for $\geq 80\text{kVA}$)

Bipolar (4Q two independent setpoints)

Voltage (CV)

Range: 2Q: 20⁽¹⁾ to 750V (800V with High Voltage option)

4Q: 0 to +350V / 0 to -350 (+ rail / 0 / - rail, Bipolar configuration)

Setpoint Resolution: 10mV

Effective Resolution⁽²⁾: < 0.05% of FS⁽³⁾

Setpoint Accuracy⁽⁴⁾: $\pm 0.1\%$ of FS⁽³⁾

Transient Time⁽⁵⁾: < 1ms (10% to 90% at a step to V_{rated})⁽¹⁰⁾

Ripple⁽⁷⁾ (peak-peak): < 0.55% of FS⁽³⁾

Current Mode (CC)

Range: from 0 to $\pm 110\%$ of I_{rated} (see models table)

Setpoint Resolution: 10mA

Effective Resolution⁽²⁾: < 0.05% of FS⁽³⁾ (< 0.1% models 7.5 & 10)

Setpoint Accuracy⁽⁴⁾: $\pm 0.2\%$ of FS⁽³⁾

Transient Time⁽⁵⁾: < 1ms (10% to 90% at a step to I_{rated})⁽¹⁰⁾

Ripple⁽⁷⁾ (peak-peak): < 0.7% of FS⁽³⁾

Power Mode (CP)

Range: from 0 to $\pm 200\%$ ⁽⁸⁾ of P_{rated} (see models table)

Derived current setpoint: $P_{\text{setpoint}} / V_{\text{measured}}$

Setpoint Resolution: 1W

Effective Resolution⁽²⁾: < 0.1% of FS⁽³⁾ (< 0.25% models 7.5 & 10)

Setpoint Accuracy⁽⁴⁾: $\pm 0.4\%$ of FS⁽³⁾

Transient Time⁽⁵⁾: < 2.5ms (10% to 90% at a step to P_{rated})⁽¹⁰⁾

Resistance Mode (CR)

Range: from 0.1 to 1000 Ohm

Derived current: $V_{\text{measured}} / R_{\text{setpoint}}$

Setpoint Resolution: 0.01 Ohm

Setpoint Accuracy⁽⁴⁾: $\pm 0.2\%$ of FS⁽³⁾

Transient Time⁽⁵⁾: < 2ms (10% to 90% at a step to R_{rated})⁽¹⁰⁾

Output side in AC (EUT side)

Terminals

Number: 4 (3 phases + 1 neutral)

Configuration of Channels

3 channels: 4Q, independent setpoints per phase

Multichannel: 4Q, independent start/stop, alarm status and setpoints per
phase (note: multichannel is an option for $\geq 80\text{kVA}$)

Output side in EL-HF

Admissible Voltage

Connection: 1-phase, 3-phase star (consult us for 3-phase delta)
Maximum: $\pm 400V$ peak
Range: 360-900Hz
35⁽¹⁾ to 277Vrms phase-neutral (295Vrms with HV option)
35⁽¹⁾ to 480Vrms phase-phase (510Vrms with HV option)
Frequency: 360 to 900Hz

Current Mode (CC)

Range: from 0 to $\pm 200\%$ ⁽⁸⁾ of I_{rated} (see models table)
Setpoint Resolution: 10mA_{rms}
Effective Resolution⁽²⁾: < 0.05% of FS⁽³⁾ (< 0.1% models 7.5 & 10)
Setpoint Accuracy⁽⁴⁾: < $\pm 0.2\%$ of FS⁽³⁾
Transient Time⁽⁵⁾: < 1.5ms (10% to 90% at a step transient)
Ripple⁽⁷⁾ (peak-peak): < 0.7% of FS⁽³⁾ (with Low Ripple Inductor option)

Phase Angle (cos ϕ)

Range: -90 to 90° in Sink / Source
Resolution: 0.01°

Harmonics

Open-loop generation of harmonics (consult us)

Power Mode (CP / CS)

Range: from 0 to $\pm 200\%$ ⁽⁸⁾ of P_{rated} (see models table)
Derived current setpoint: calculated from ISI and $\Phi(S)$
Setpoint Resolution: 1W, 1VA
Effective Resolution⁽²⁾: < 0.1% of FS⁽³⁾ (< 0.25% models 7.5 & 10)
Setpoint Accuracy⁽⁴⁾: $\pm 0.4\%$ of FS⁽³⁾
Transient Time⁽⁵⁾: < 2.5ms (10% to 90% at a step to P_{rated})

Impedance Mode (CZ)

Range: from 0.8 to 1000 Ohm, 0.1 to 2000mH, 0 to 3.7mF
Derived current/phase setpoint: calculated from IZI and $\Phi(Z)$
Setpoint Resolution: 0.01 Ohm/mH/mF
Setpoint Accuracy⁽⁴⁾: see current accuracy
Transient Time⁽⁵⁾: < 2.5ms (10% to 90% at a step to R_{rated})

Operation Modes

DC

Programmable Voltage (CV)
Programmable Current (CC)
Programmable Power (CP)
Programmable Resistance (CR)
Power Amplifier (HiL)
Steps
Optional Battery Testing (BTest) (charge/discharge/cycling)
Optional Battery Emulation (BEmu)
Optional PV Panel Emulation (PVEmu)

HF

Programmable Current (CC)
Programmable Power (CP / CS)
Programmable Impedance (CZ)
Steps

Overload/ Overcurrent

Admissible DC overcurrent is: 110% of rated value during 1 minute
Admissible AC overcurrent: 125% of rated value during 10 minutes,
150% during 1 minute, 200% during 2 seconds
Admissible overloads: 125% of rated value during 10 minutes,
150% during 1 minute, 200% during 2 seconds

User Interface

Local Control (4.3" Touchscreen panel)

Isolated Digital port: 6 inputs, 4 outputs
 Isolated Analogue port: 6 inputs (rms setpoints or power amplifier), 6 outputs (rms readback or real-time readback)
 Interlock port: 1 NC Input, 1 NO Output
 Emergency Stop pushbutton

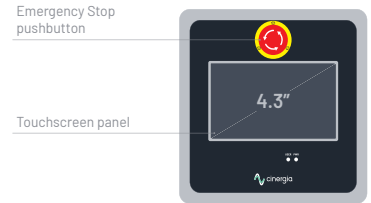

Remote Control Port

LAN Ethernet with Open Modbus-TCP protocol
 RS485 (option), CAN and RS232 (using external gateway)

Software

Graphical User Interface for Windows 7/10
 LabView drivers and open Labview interface example

Enhanced

Master/Slave Operation

Connection: fiber optics link (x6)
 Configuration: from software user interface/MODBUS up to 8 units:
 AC: Parallel
 DC: Parallel, serial or serial-parallel

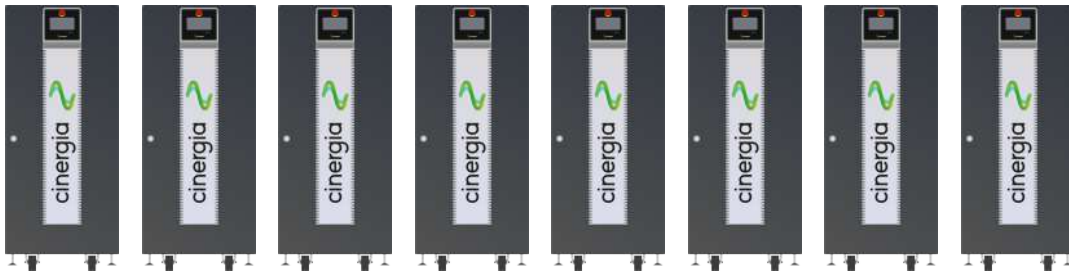

Size and Weight

Models 7.5 to 60

Height

1100 mm

Width

450 mm

Depth

770 mm

Weight

200 kg

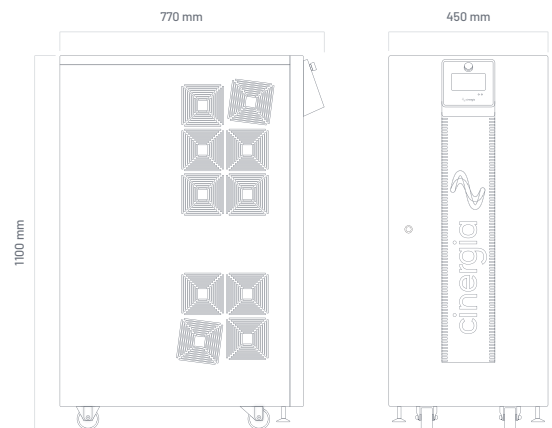

Connections

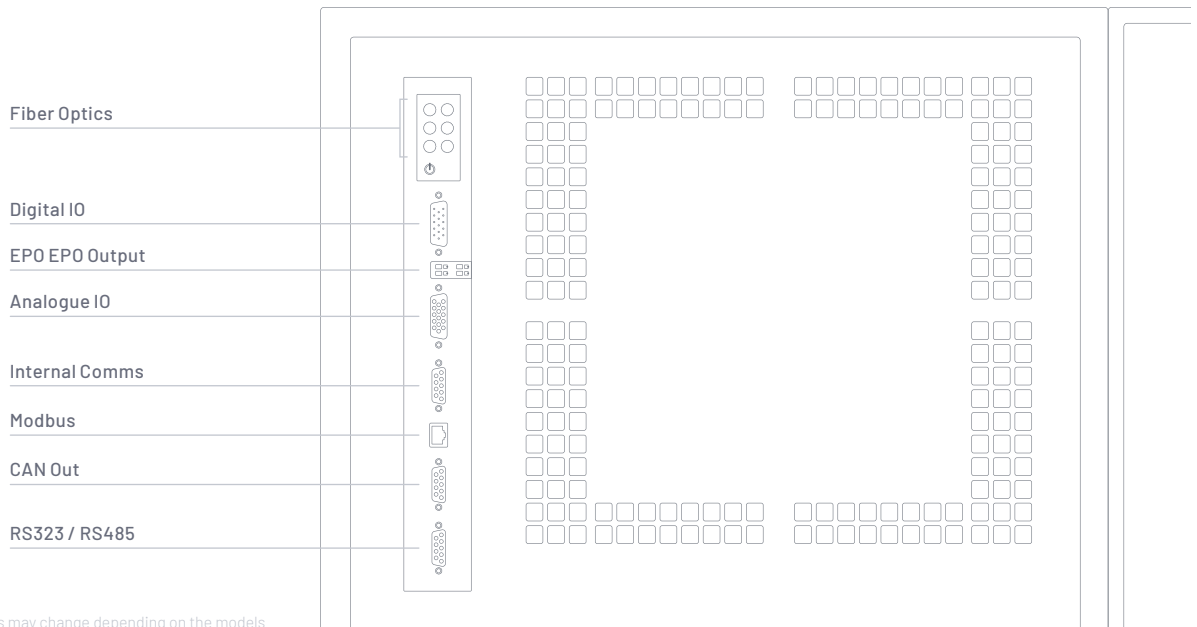

The distribution of the connectors may change depending on the models

Selectors

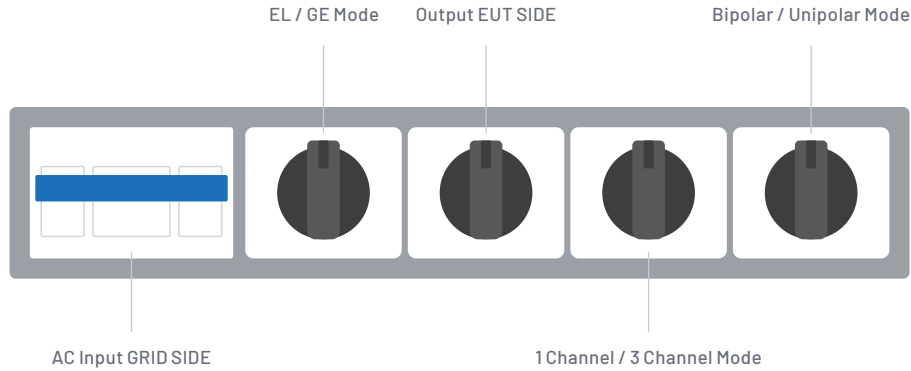

The type of selectors and their location may change depending on the models

Protections

Overvoltage (peak, rms), Overcurrent (peak, rms), Overload
Shortcircuit, Emergency Stop, Watchdog, Heart Beat, Output
Contactor, Wrong Configuration
Alarms and Limits are user configurable and can be saved in a
password protected EEPROM

Mesurements ⁽⁶⁾

Grid Voltage (rms), Current (rms), Power (P,O) and Frequency
Output Voltage (rms, avg), Current (rms, avg), Power (P,O) and Frequency
Heatsink Temperatures (x2) and DC Link Voltage
Datalogging available through FTP connection

Ambient

Operating temperature⁽⁸⁾ : 5-40°C
Relative Humidity: up to 95%, non-condensing
Cooling: Forced air
Acoustic noise at 1m: < 52dB(A)(7.5 to 60), < 65dB(A)(80 to 120), < 70dB(A)(160 and 200)

Standards

CE Marking
Operation and Safety: EN-50178, EN-62040-1
EMC: EN-62040-2
RoHS

All specifications are subject to change without notice.

Options

Choose your options:

- Three channel mode: allows different operation mode start/stop/reset per channel
- 30kHz Switching Frequency: only available for models 15 (derated to 7.5kW), 20 (derated to 7.5kW) and 30 (derated to 10kW)
- Isolation monitor (advised for IT systems)
- Low current ripple inductance (included in all models ≤54kW. optional for models ≥80kW)
- High Frequency 360 - 900 Hz
- Anti-islanding monitor (only advised in net injection to the grid and following local regulations)
- High Voltage (HV): voltage up to 295Vrms phase-neutral in AC up to 800V in DC
- RS485
- Battery Emulation
- Battery Test
- PV Panel Emulation

All specifications are subject to change without notice.

1. Minimum voltage setpoint is 0V in DC. The recommended minimum setpoint for long-term use is 20Vrms in AC and 20V in DC.
2. Effective resolution measured with a 400ms window
3. FS Range of voltage is 830V (with High Voltage option)
FS Range of current is $2 \cdot |3 \cdot I_{rated}|$ (see models table)
FS Range of power is $2 \cdot |200\% \cdot Prated|$ (see models table)
4. Accuracies are valid for settings above 10% of FS
5. Measured with the rated resistive load and high-dynamics controllers configuration.
6. Accuracy of measurements is $\pm 0.1\%$ of FS for rms voltage, $\pm 0.2\%$ of FS for rms current, $\pm 0.4\%$ of FS for active power (valid only above 10% of FS)
7. Consult us for lower voltage/current ripple requirements
8. Rated power figures are given at 20°C
9. The maximum output voltage depends on frequency following $V \cdot f < 46000$
10. With fast DC control behaviour

Models

EL+ vHF/DC

Reference	AC Power Rated ⁽⁹⁾	AC Current Rated ⁽⁹⁾ RMS 3 channels / 1 channel	DC Power Rated ⁽⁹⁾	DC Current Rated ⁽⁹⁾ RMS 3 channels / 1 channel	Weight (kg) (kg)	Dimensions DxWxH (mm) (inch)
EL+15 vHF/DC	15 kW	20 A / 60 A	15 kW	±20A / ±60A	155 kg	770 x 450 x 1100 mm 30.31 x 17.71 x 43.30 "
EL+20 vHF/DC	20 kW	26 A / 78 A	20 kW	±25A / ±75A	341.71 lbs	
EL+30 vHF/DC	27 kW	40 A / 120 A	27 kW	±30A / ±90A		
EL+40 vHF/DC	40 kW	52 A / 156 A	40 kW	±40A / ±120A	200 kg	
EL+50 vHF/DC	50 kW	65 A / 195 A	50 kW	±50A / ±150A	440.92 lbs	

All specifications are subject to change without notice.

For EL mode is not available a physical 3 channel/1 channel switch. To work in a single phase mode, it's necessary to introduce a monophasic grid at the output.

Galvanic Isolation

	Circuit Breaker Recommended	Weight (kg) (lbs)
Inside the cabinet	IT 7.5i	Type C - 25 A
	IT 10i	Type C - 25 A
	IT 15i	Type C - 32 A
	IT 20i	Type C - 40 A
	IT 30i	Type C - 50 A
	IT 40i*	Type C - 63 A
	IT 50i*	Type C - 83 A

*In the IT 40i and IT 50i models the size of the cabinet increases to a total of 770 x 835 x 1100 mm (27.55 x 32.87 x 43.31"). The others keep the original size.

	Circuit Breaker Recommended	Weight (kg) (lbs)	Dimensions D x W x H (mm) (inch)
In external cabinet IP20	IT 30e	Type D - 80 A	174 kg 383.60 lbs
	IT 40e	Type D - 100 A	217 kg 478.40 lbs
	IT 50e	Type D - 125 A	280 kg 617.29 lbs
	IT 60e	Type D - 160 A	381 kg 839.96 lbs
	IT 80e	Type D - 200 A	435 kg 959.01 lbs
	IT 100e	Type D - 250 A	458 kg 1009.72 lbs
	IT 120e	Type D - 315 A	514 kg 1133.18 lbs
	IT 160e	Type D - 400 A	612 kg 1349.23 lbs
	IT 200e	Type D - 500 A	753 kg 1660.10 lbs

Configuration Modes

EL+ AC	PHiL DC	PHiL AC	DC
--------	---------	---------	----

Master / Slave

Parallel	in AC modes (GE & EL)		
Parallel	Serial	Serial Parallel	in DC mode

Channel Configuration in EL

3 channels	* 1 channel	*For 1-channel configuration contact us.
------------	-------------	--

Channel Configuration in DC

3 channels	1 channel	Bipolar	Unipolar
------------	-----------	---------	----------

Regenerative
Power Electronic
Solutions



Mess- und Prüftechnik. Die Experten.

Ihr Ansprechpartner /
Your Partner:

dataTec AG
E-Mail: info@datatec.eu
>>> www.datatec.eu

