

5 Series MSO Low Profile

MSO58LP Datasheet

More system visibility in less rack space.



Standard rack mount configuration



Optional bench conversion configuration

Key performance specifications

Input channels

- 8 FlexChannel® inputs
- Each FlexChannel provides:
 - One analog signal that can be displayed as a waveform view, a spectral view, or both simultaneously
 - Eight digital logic inputs with TLP058 logic probe

Bandwidth (all analog channels)

- 1 GHz, 500 MHz (upgradable)

Sample rate (all analog / digital channels)

- Real-time: 6.25 GS/s
- Interpolated: 500 GS/s

Record length (all analog / digital channels)

- 125 Mpoints (std.)
- 250, 500 Mpoints (optional)

Waveform capture rate

- >500,000 waveforms/s

Vertical resolution

- 12-bit ADC
- Up to 16-bits in High Res mode
- 7.6 ENOB at 1 GHz

Standard trigger types

- Edge, Pulse Width, Runt, Timeout, Window, Logic, Setup & Hold, Rise/Fall Time, Parallel Bus, Sequence, Visual Trigger, Video (optional), RF vs. Time (optional)
- Auxiliary Trigger $\leq 5 V_{RMS}$, 50Ω, 200 MHz (Edge Trigger only)

Standard analysis

- Measurements: 36
- Spectrum View: Frequency-domain analysis with independent controls for frequency and time domains RF vs. time traces (magnitude, frequency, phase)
- FastFrame™: Segmented memory acquisition mode with maximum trigger rate >5,000,000 waveforms per second
- Plots: Time Trend, Histogram, Spectrum and Phase Noise
- Math: Basic waveform arithmetic, FFT, and advanced equation editor
- Search: Search on any trigger criteria
- Jitter: TIE and Phase Noise

Optional analysis (optional and upgradable)

- Advanced Jitter and Eye Diagram Analysis
- User-defined filtering
- Advanced Spectrum View
- RF vs. Time traces, triggers, Spectrograms, and IQ capture
- Digital Power Management
- Mask/Limit Testing
- Inverters, Motors, and Drives
- Advanced Power Measurements and Analysis

Optional protocol trigger, decode, and analysis (optional and upgradable)

I²C, SPI, eSPI, I3C, RS-232/422/485/UART, SPMI, SMBus, CAN, CAN FD, CAN XL, LIN, FlexRay, SENT, PSi5, CXPI, Automotive Ethernet, MIPI C-PHY, MIPI D-PHY, USB 2.0, eUSB2.0, Ethernet, EtherCAT, Audio, MIL-STD-1553, ARINC 429, Spacewire, 8B/10B, NRZ, Manchester, SVID, SDLC, 1-Wire, MDIO, and NFC

Arbitrary/Function Generator (optional and upgradable)

- 50 MHz waveform generation
- Waveform Types: Arbitrary, Sine, Square, Pulse, Ramp, Triangle, DC Level, Gaussian, Lorentz, Exponential Rise/Fall, Sin(x)/x, Random Noise, Haversine, Cardiac

Digital voltmeter (free with product registration)

- 4-digit AC RMS, DC, and DC+AC RMS voltage measurements

Trigger frequency counter (free with product registration)

- 8-digit

Video display output

- High Definition (1,920 x 1,080) resolution video output

Connectivity

- USB Host (6 ports), USB 3.0 Device (1 port), LAN (10/100/1000 Base-T Ethernet), Display Port, DVI-D, VGA

e*Scope®

- Remotely view and control the oscilloscope over a network connection through a standard web browser

Operating system

- Closed Embedded OS

Warranty

- 3 years standard

Dimensions

- 2U Rack Mount Kit included
- 3.44 in (87.3 mm) H x 17.01 in (432 mm) W x 24.74 in (621.5 mm) D
- Weight: 28 lbs. (12.7 kg)

With a remarkable 8 input channels in a 2U high package and a 12-bit ADC, the 5 Series MSO Low Profile sets a new standard for performance in applications where extreme analog, spectrum, or digital channel density is required.

Based on the highly successful 5 Series MSO

The 5 Series MSO Low Profile is based on the 5 Series MSO benchtop platform. The benchtop 5 Series MSO has a remarkably innovative pinch-swipe-zoom touchscreen user interface, the industry's largest high-definition display, and 4, 6, or 8 FlexChannel® inputs that let you measure a single analog channel waveform, a spectral view of the analog input, simultaneous analog and spectral views with independent acquisition controls for each domain, or eight digital logic inputs (with

TLP058 logic probe). The 5 Series MSO is ready for today's toughest challenges, and tomorrow's too. It sets a new standard for performance, analysis, and overall user experience.

Like the benchtop 5 Series MSO, the low profile instrument offers FlexChannel inputs, an optional arbitrary/function generator output, and a built-in digital voltmeter and trigger frequency counter. And, if you plug in an external touch-capable monitor you can experience the same revolutionary pinch-swipe-zoom user experience as if you were in front of the benchtop 5 Series MSO.

For more information on the capabilities of the benchtop 5 Series MSO, including the revolutionary user experience and the various analysis software options, please see the 5 Series MSO datasheet at www.tek.com/5SeriesMSO.



The 5 Series MSO Low Profile is based on the 5 Series MSO benchtop platform.

Low-profile, high-density package saves space

The 5 Series MSO Low Profile has 8 FlexChannel inputs plus an auxiliary trigger input in a space-saving 2U high package designed to fit into 19-inch wide racks. The instrument has side air vents so that instruments can be mounted in a rack directly on top of one another, saving even more space.

The 5 Series MSO Low Profile comes standard with rack mount brackets installed, ready for mounting into a rack right out of the box.



Multiple MSO58LP instruments installed in a rack, making efficient use of available space.

An optional bench conversion kit includes four feet and a strap handle for use in a lab environment on a bench surface.



The MSO58LP with the optional bench conversion kit installed, optimizing the instrument for use on a benchtop.

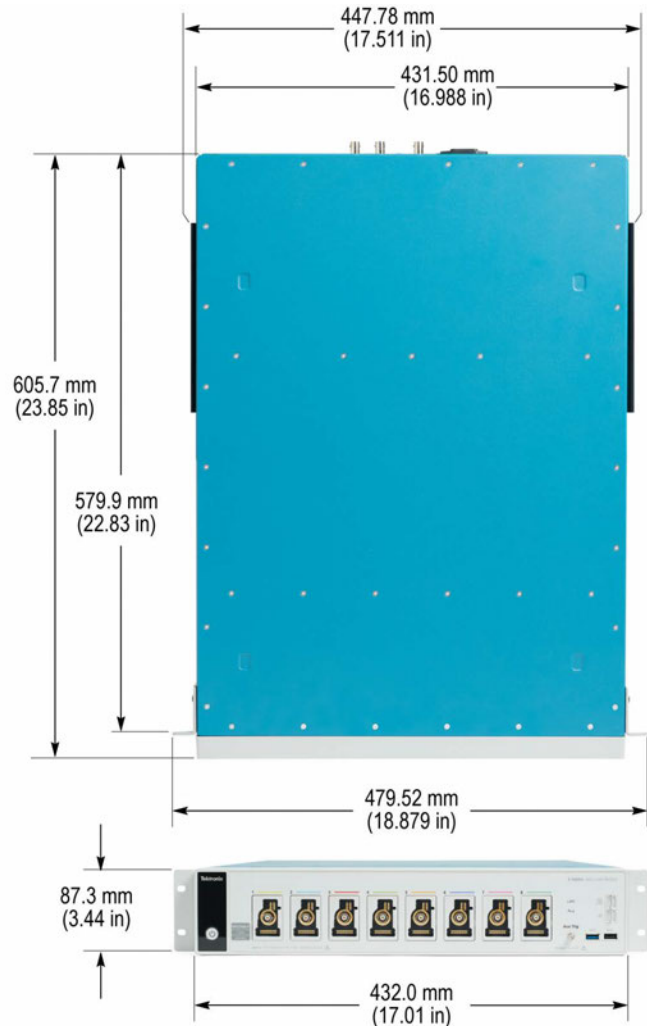

The 5 Series MSO Low Profile saves valuable rack space.

Experience the performance difference

With up to 1 GHz analog bandwidth, 6.25 GS/s sample rate, 500 Mpts record length, and 12-bit analog to digital converters (ADCs), the 5 Series MSO Low Profile has the performance you need to capture accurate waveform data with the best possible signal integrity and vertical resolution for seeing small waveform details.

The 5 Series MSO Low Profile has up to 6.25 GS/s sample rate on all channels, providing more than 5x oversampling, enabling better noise performance and fine timing resolution.

The optional 500 Mpts record length provides 80 ms of acquisition time at the highest sample rate (6.25 GS/s), enabling long time captures while maintaining high timing resolution for more accurate measurements.

Industry leading vertical resolution

The 5 Series MSO Low Profile provides the performance to capture the signals of interest while minimizing the effects of unwanted noise when you need to capture high-amplitude signals while seeing smaller signal details. At the heart of the 5 Series MSO Low Profile are 12-bit analog-to-digital converters (ADCs) that provide 16 times the vertical resolution of traditional 8-bit ADCs.

A new High Res mode applies a hardware-based unique Finite Impulse Response (FIR) filter based on the selected sample rate. The FIR filter maintains the maximum bandwidth possible for that sample rate while preventing aliasing and removing noise from the oscilloscope amplifiers and ADC above the usable bandwidth for the selected sample rate.

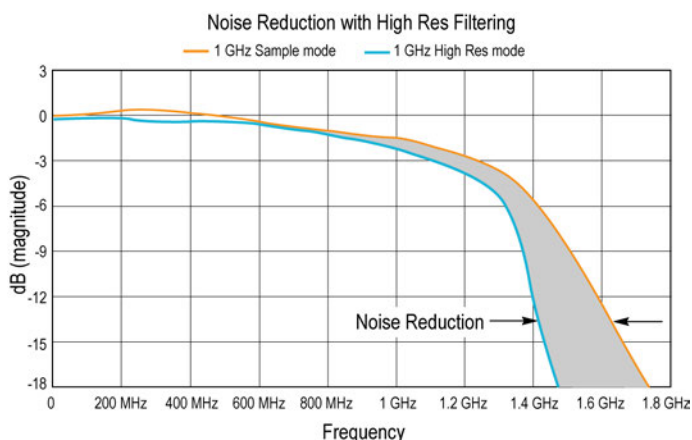

1 GHz frequency plot with High Res filter overlaid shows the reduction in noise when High Res mode is enabled

High Res mode always provides at least 12 bits of vertical resolution and extends all the way to 16 bits of vertical resolution at ≤ 125 MS/s sample rates. The following table shows the number of bits of vertical resolution for each sample rate setting when in High Res.

Sample rate	Number of bits of vertical resolution
6.25 GS/s ¹	8
3.125 GS/s	12
1.25 GS/s	13
625 MS/s	14
312.5 MS/s	15
≤ 125 MS/s	16

Typical 8-bit ADC oscilloscopes have an Effective Number of Bits (ENOB) of between 4 and 6, depending on bandwidth and vertical scale selected. The 12-bit ADC in the 5 Series MSO Low Profile, coupled with a new low-noise front-end amplifier, provides an ENOB of between 7 and 9 bits, enabling better viewing of fine signal detail in the presence of large amplitude signals.

The following table shows the typical ENOB values for the 5 Series MSO Low Profile measured with High Res mode, 50 Ω , 10 MHz input with 90% full screen.

Bandwidth	ENOB
1 GHz	7.6
500 MHz	7.9
350 MHz	8.2
250 MHz	8.1
20 MHz	8.9

Spectrum View

It is often easier to debug an issue by viewing one or more signals in the frequency domain. Oscilloscopes have included math-based FFTs for decades in an attempt to address this need. However, FFTs are notoriously difficult to use as they are driven by the same acquisition system that's delivering the analog time-domain view. When you optimize acquisition settings for the analog view, your frequency-domain view isn't what you want. When you get the frequency-domain view you want, your analog view is not what you want. With math-based FFTs, it is virtually impossible to get optimized views in both domains.

Spectrum View changes all of this. Tektronix' patented technology provides both a decimator for the time-domain and a digital downconverter for the frequency-domain behind each FlexChannel. The two different acquisition paths let you simultaneously observe both time- and frequency-domain views of the input signal with independent acquisition settings for each domain. Other manufacturers offer various 'spectral analysis' packages that claim ease-of-use, but they all exhibit the limitations described above. Only Spectrum View provides both

¹ 6.25 GS/s not available as real-time sample rate when High Res is on.

exceptional ease-of-use and the ability to achieve optimal views in both domains simultaneously.

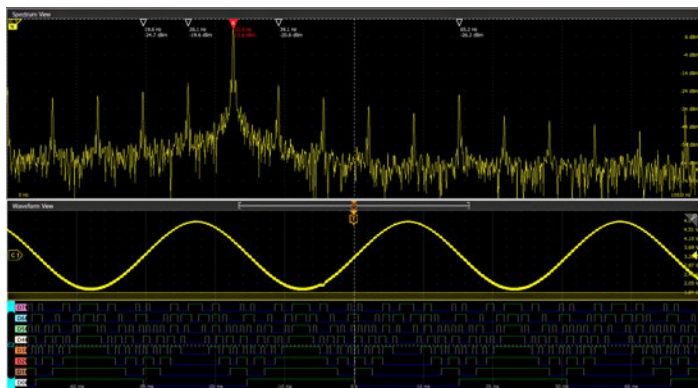

Intuitive spectrum analyzer controls like center frequency, span and resolution bandwidth (RBW), independent from time domain controls, provide easy setup for frequency domain analysis. A spectrum view is available for each FlexChannel analog input, enabling multi-channel mixed domain analysis.

TekVPI Probe Interface

The TekVPI® probe interface sets the standard for ease of use in probing. In addition to the secure, reliable connection that the interface provides, many TekVPI probes feature status indicators and controls, as well as a probe menu button right on the probe compensation box. The TekVPI interface enables direct attachment of current probes without requiring a separate power supply. TekVPI probes can be controlled remotely through USB or LAN, enabling more versatile solutions in ATE environments. The 5 Series MSO Low Profile provides up to 80 W of power to the front panel connectors, sufficient to power all connected TekVPI probes without the need for an additional probe power supply.

The TekVPI probe interface is key to enabling the high bandwidth and low attenuation versions of the optional TPP Series of passive voltage probes. The TPP Series probes offer all the benefits of general-purpose probes -- high dynamic range, flexible connection options, and robust mechanical design, while providing the performance of active probes. At 1 GHz bandwidth, the optional TPP1000 probes enable you to see high frequency components in your signals, and extremely low 3.9 pF capacitive loading minimizes adverse effects on your circuits. The optional low-attenuation (2x) TPP0502 has 500 MHz bandwidth and is exceptional at measuring low voltages.



MSO58LP with TekVPI probes and touch monitor attached for use in a lab environment.

Designed with your needs in mind

Remote operation to speed automated test

IVI-COM², IVI-C³, and LabVIEW² instrument drivers are available for free and enable easy communication with the oscilloscope using LAN or USBTMC connections from an external PC. A full set of programmatic commands to setup and control the instrument remotely enable easy test automation.

Building a next-generation test rack

Looking for a modern way to refresh your test rack, view, download or analyze your data? Looking to replace obsolete hardware without rewriting your code?

We understand that test rack designs take time and include numerous tradeoffs. Tektronix has heard your voice loud and clear and is blazing a new path to provide a richer set of tools to enable flexible ways to access data and replace obsolete hardware. If that means you're automating a test rack with LabVIEW, Python or another interface, we have an expanding number of drivers and numerous support resources available.

Maybe you require an easy way to view waveforms on a remote computer. Not a problem, Tektronix has a software team designing new ways to control the instrument from a browser (E*Scope), store your data in the cloud (TekCloud), or stream data to our PC (TekScope). Providing modern age tools at your fingertips.

Lastly, users familiar with keyboards, mice, monitors, and KVM switches can continue to operate as they always have!

² Drivers are available from www.tek.com/downloads.

³ Drivers are available from www.ni.com.



TekCloud

All your data in one place.

Upgrade Automated Test Equipment (ATE) systems quickly and smoothly

Was your automation code written in the 1970s, 1980s, or 1990s?

Anyone working closely with automated test systems knows that moving to a new model or platform can be painful. Modifying an existing codebase for a new product can be prohibitively expensive and complicated. Now there's a solution.

All 5 and 6 Series Low Profile instruments include a Programmatic Interface (PI) Translator. When enabled, the PI Translator acts as an intermediate layer between your test application and the digitizer. The PI translator recognizes a subset of legacy commands from the popular DPO/MSO5000B, DPO7000C, and DPO70000C oscilloscope platforms and translates them on the fly into supported commands. The interface is designed to be human-readable and easily extensible, which means that you can customize its behavior to minimize the amount of effort required when transitioning from obsolete instruments to the newest Tektronix platform.

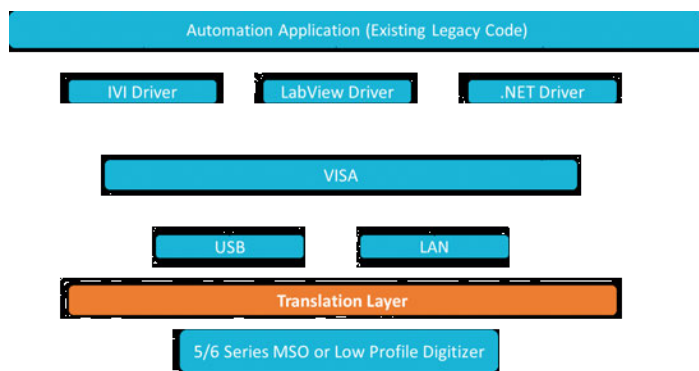

How the PI Translator works from Automation software to Tek instrument

Access data in all the new ways you can dream about

Using TekDrive, you can upload, store, organize, search, download, and share any file type from any connected device. TekDrive is natively integrated into the 5 Series Low Profile instrument for seamless sharing and recalling of files - no USB stick is required. Analyze and explore standard files like .wfm, .isf, .tss, and .csv, directly in a browser with smooth interactive waveform viewers. TekDrive is purpose-built for integration, automation, and security. www.tekcloud.com/tekdrive



Programming with a Low Profile in a test rack has never been easier

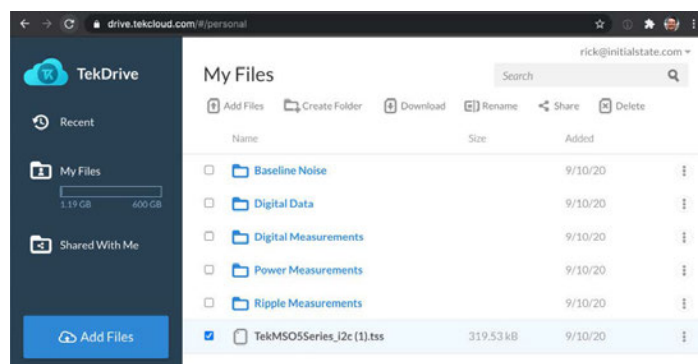

TekDrive collaborative workspace - save files directly from your 5 Series Low Profile and share across your team

Get the analysis capability of an award-winning oscilloscope on your PC. Analyze waveforms anywhere, anytime. The basic license lets you view and analyze waveforms, perform many types of measurements and decode the most common serial buses - all while remotely accessing your oscilloscope. Advanced license options add capabilities such as multi-scope analysis, more serial bus decoding options, jitter analysis and power measurements. TekScope Multi-Scope enables you to connect and download data from up to 4 instruments (16-32 max channels) for easy viewing and cross-instrument analysis.

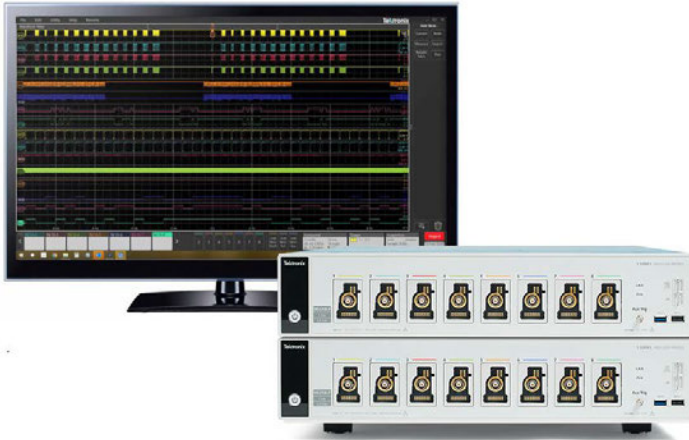

Two MSO58LP instruments being analyzed on PC running TekScope's 'Multi-Scope'

E*Scope is an easy method of viewing and controlling a 5 Series Low Profile instrument over a network connection in the same way that you do in-person with a monitor or keyboard. Simply type the instrument's IP address into a browser to display the LXI landing page, then select the Instrument Control to access E*Scope. There are no drivers needed. It's all self-contained within the browser and you can control the instrument. It's fast, responsive, and perfect for controlling or visualizing single or multiple instrument situations.

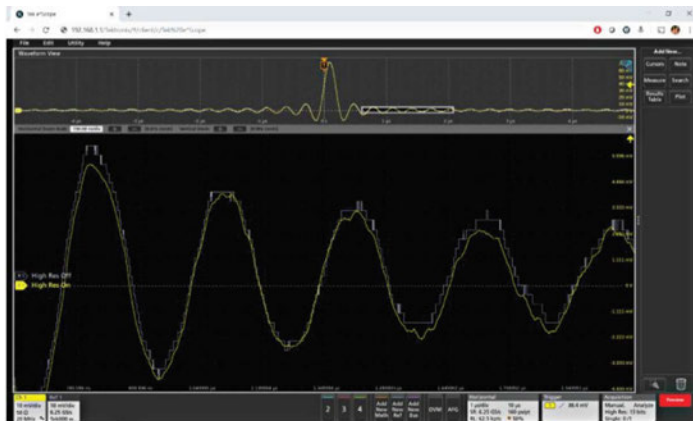

Live browser control is available using e*Scope via a browser like Chrome, Firefox, or Edge.

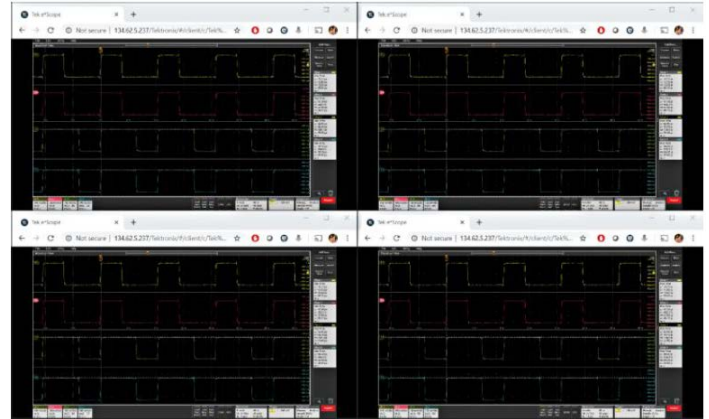

Tile multiple e*Scope browser tabs on a monitor for viewing live data

Enhanced security option

The 5-SEC enhanced security option enables password-protected enabling/disabling of all USB communication ports and firmware upgrades. In addition, option 5-SEC provides the highest level of security by ensuring that internal memory is clear of all setup and waveform data. This ensures you can confidently move the instrument out of a secure area.

To permanently store data, you can save it to an external flash memory device or programmatically to USBTMC ports in keeping with your lab security protocols.

User-defined filtering (optional)

In the broad sense, any system that processes a signal can be thought of as a filter. For example, an oscilloscope channel operates as a low pass filter where its 3 dB down point is referred to as its bandwidth. Given a waveform of any shape, a filter can be designed that can transform it into a defined shape within the context of some basic rules, assumptions, and limitations.

Digital filters have some significant advantages over analog filters. For example, the tolerance values of analog filter circuit components are high enough that high order filters are difficult or even impossible to implement. High order filters are easily implemented as digital filters. Digital filters can be implemented as Infinite Impulse Response (IIR) or Finite Impulse Response (FIR). The choice of IIR or FIR filters are based upon design requirements and application.

The MSO58LP has the ability to apply designated filters to math waveforms through a MATH arbitrary function. Option 5-UDFLT takes this functionality a level deeper, providing more than MATH arbitrary basic functions and adds flexibility to support standard filters and can be used for application centric filter designs.

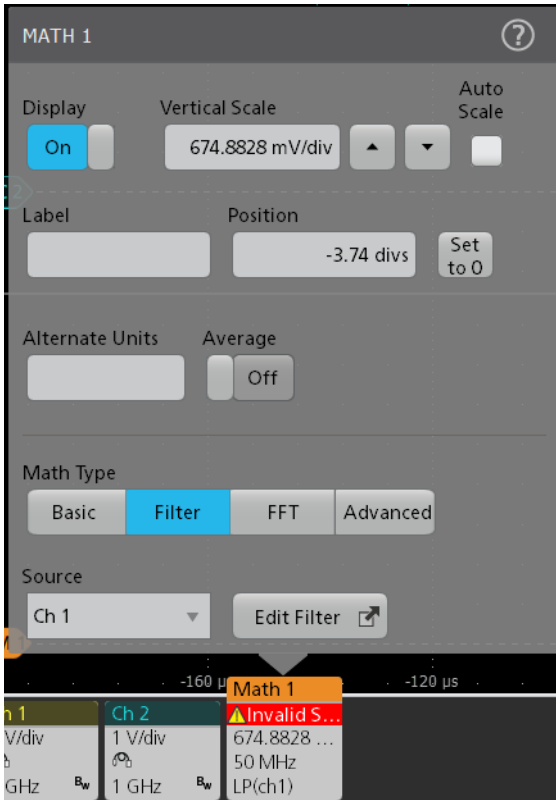

Filters can be created through the Math dialog. Once a filter is edited, it can be easily applied, saved, and recalled for use or modification later.

Filter types supported on the MSO58LP include:

- Low pass
- High pass
- Band pass
- Band stop
- All pass
- Hilbert
- Differentiator
- Custom

Filter response types supported on the MSO58LP include:

- Butterworth
- Chebyshev I
- Chebyshev II
- Elliptical
- Gaussian
- Bessel-Thomson

The Filter Response control is available for all Filter Types except All-pass, Hilbert, or Differentiator.

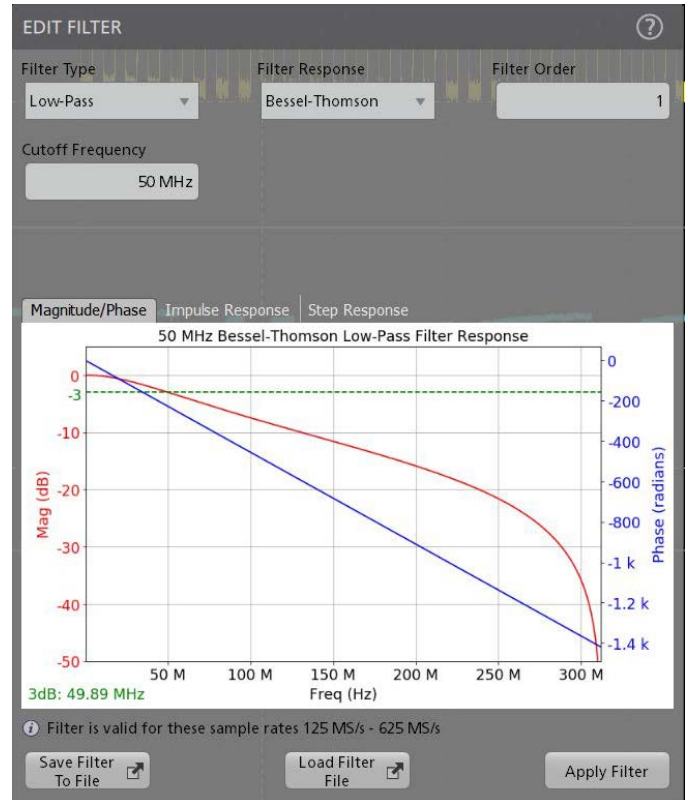

Filter creation dialog showing selection for Filter Type, Filter Response, Cutoff Frequency, Filter Order, and a graphical representation of Magnitude/Phase, Impulse Response, and Step Response

Filter designs can be saved, recalled, and applied once any editing has been completed.

Quickly transition from the lab to manufacturing

The 5 Series MSO Low Profile is based on the successful 5 Series MSO platform. This means you can use the benchtop 5 Series MSO with its beautiful 15.6-in touch display and its full measurement analysis capabilities during the development process. Then, when you are ready to transition your product to manufacturing, you can use the same software and test routines developed during R&D in your manufacturing test application, saving time and rack space.

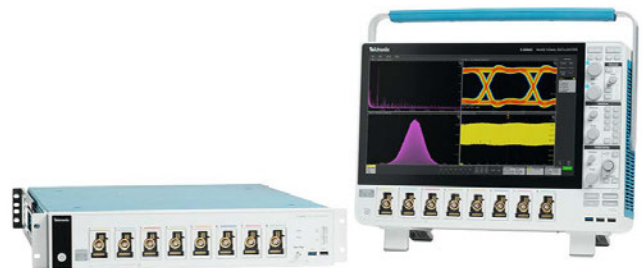

Use the benchtop 5 Series MSO during R&D, then seamlessly transition to the low profile version for manufacturing test.

The Low Profile family

The 6 Series Low Profile Digitizer expands the performance of the 5 Series MSO Low Profile by adding twice the number of Tektronix TEK049 ASICS in the same 2U footprint. Now with 25 GS/s and up to 8 GHz on all channels. Low Profile users now have the choice of extreme high channel count or extreme performance in the same rack form factor.

For more information on the capabilities of the 6 Series Low Profile Digitizer, please see the datasheet at www.tek.com/high-speed-digitizer/



Two 6 Series Low Profile Digitizers (left) and two 5 Series MSO Low Profile oscilloscopes (right)

Quick Comparison	6 Series Low Profile Digitizer	5 Series MSO Low Profile Digitizer
Sample Rate	25 GS/s	6.25 GS/s
Analog Bandwidth	Up to 8 GHz	up to 1 GHz
RF (DDC) Span Bandwidth	2 GHz	500 MHz
ENOB @ 1 GHz	8.2 bits	7.6 bits
LXI compliance version	1.5	-
Rack Dimensions	2U	2U

5 Series MSO Low Profile - The highest channel density and greatest performance in its class

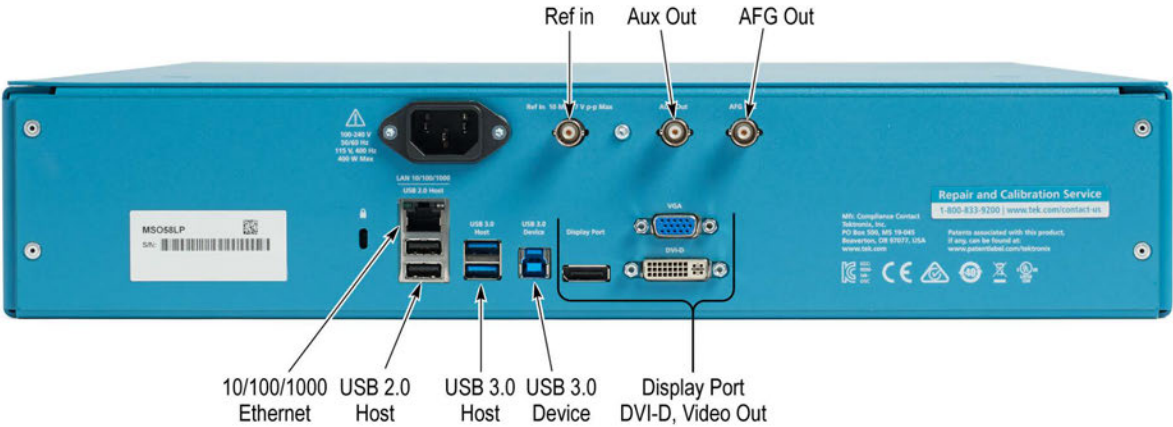
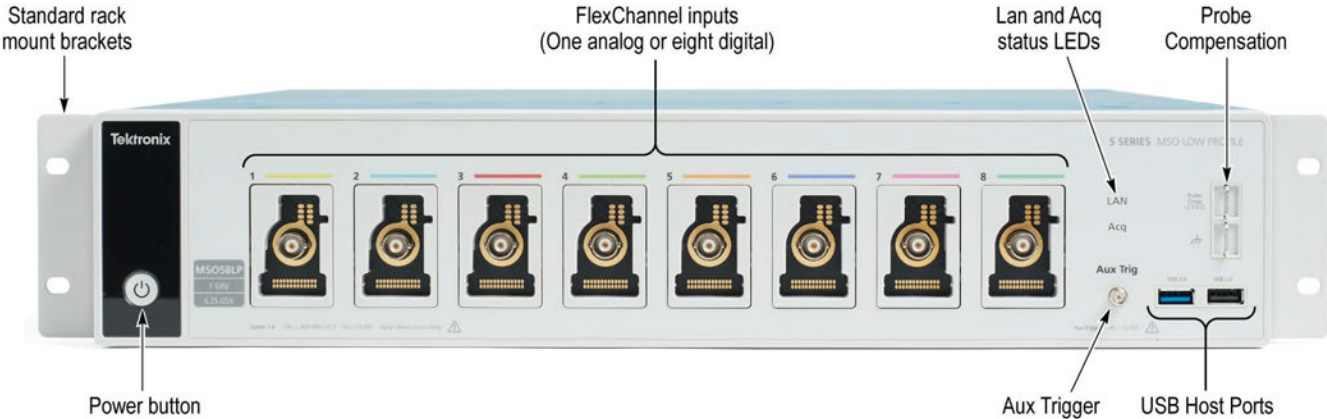

Specifications

All specifications are guaranteed and apply to all models unless noted otherwise.

Model overview

Oscilloscope

	MSO58LP, MSO58LPGSA
FlexChannel inputs	8
Maximum analog channels	8
Maximum digital channels (with optional logic probes)	64
Bandwidth (calculated rise time)	500 MHz (800 ps), 1 GHz (400 ps)
DC Gain Accuracy	50 Ω : $\pm 1.0\%$, ($\pm 2.0\%$ at ≤ 1 mV/div), $\pm 0.5\%$ of full scale, ($\pm 1.0\%$ of full scale at 1 mV/Div and 500 μ V/Div Settings) 1 M Ω : $\pm 1.0\%$, ($\pm 2.0\%$ at ≤ 1 mV/div), $\pm 0.5\%$ of full scale, ($\pm 1.0\%$ of full scale at 1 mV/Div and 500 μ V/Div Settings)
ADC Resolution	12 bits
Vertical Resolution	8 bits @ 6.25 GS/s 12 bits @ 3.125 GS/s 13 bits @ 1.25 GS/s (High Res) 14 bits @ 625 MS/s (High Res) 15 bits @ 312.5 MS/s (High Res) 16 bits @ ≤ 125 MS/s (High Res)
Sample Rate	6.25 GS/s on all analog / digital channels (160 ps resolution)
Record Length	Up to 500 Mpoints on all analog / digital channels
Waveform Capture Rate	>500,000 wfms/s
Arbitrary/Function Generator (opt.)	13 predefined waveform types with up to 50 MHz output
DVM	4-digit DVM (free with product registration)
Trigger Frequency Counter	8-digit frequency counter (free with product registration)

Vertical system- analog channels

Bandwidth selections 50 Ω : 20 MHz, 250 MHz, and the full bandwidth value of your model
1 M Ω : 20 MHz, 250 MHz, 500 MHz

Input coupling DC, AC

Input impedance 50 $\Omega \pm 1\%$
1 M $\Omega \pm 1\%$ with 13.0 pF ± 1.5 pF

Input sensitivity range

1 M Ω 500 μ V/div to 10 V/div in a 1-2-5 sequence
50 Ω 500 μ V/div to 1 V/div in a 1-2-5 sequence

500 $\mu\text{V}/\text{div}$ is a 2X digital zoom of 1 mV/div

Maximum input voltage

50 Ω : 5 V_{RMS} , with peaks $\leq \pm 20$ V (DF $\leq 6.25\%$)

1 $M\Omega$: 300 V_{RMS} , CAT II

Derate at 20 dB/decade between 4.5 MHz and 45 MHz; derate 14 dB/decade between 45 MHz and 450 MHz.
Above 450 MHz, 5.5 V_{RMS}

Effective bits (ENOB), typical

< 1 GHz models, High Res mode, 50 Ω , 10 MHz input with 90% full screen

Bandwidth	ENOB
1 GHz	7.6
500 MHz	7.9
350 MHz	8.2
250 MHz	8.1
20 MHz	8.9

Random noise, RMS, typical

1 GHz, High Res mode (RMS)

1 GHz V/div	50 Ω					1 $M\Omega$			
	1 GHz	500 MHz	350 MHz	250 MHz	20 MHz	500 MHz	350 MHz	250 MHz	20 MHz
1 mV/div ⁴	254 μV	198 μV	141 μV	118 μV	70.0 μV	189 μV	143 μV	118 μV	64.8 μV
2 mV/div	255 μV	198 μV	143 μV	121 μV	70.4 μV	194 μV	145 μV	121 μV	66.0 μV
5 mV/div	262 μV	202 μV	150 μV	133 μV	72.8 μV	196 μV	152 μV	130 μV	69.6 μV
10 mV/div	283 μV	218 μV	169 μV	158 μV	79.8 μV	212 μV	167 μV	154 μV	78.2 μV
20 mV/div	357 μV	273 μV	222 μV	223 μV	102 μV	269 μV	214 μV	223 μV	104 μV
50 mV/div	677 μV	516 μV	436 μV	460 μV	196 μV	490 μV	410 μV	480 μV	207 μV
100 mV/div	1.61 mV	1.23 mV	1.02 mV	1.04 mV	464 μV	1.16 mV	964 μV	1.05 mV	475 μV
1 V/div	13.0 mV	9.88 mV	8.41 mV	8.94 mV	3.77 mV	13.6 mV	10.6 mV	11.1 mV	5.47 mV

⁴ Bandwidth at 500 $\mu\text{V}/\text{div}$ is limited to 250 MHz in 50 Ω .

DC gain accuracy**50 Ohm** $\pm 2.0\%$ ⁵ ($\pm 2.0\%$ at 2 mV/div, $\pm 4\%$ at 1 mV/div, typical) $\pm 1.0\%$ ⁶ of full scale, ($\pm 1.0\%$ of full scale at 2 mV/div, $\pm 2\%$ at 1 mV/div, typical)**Position range** ± 5 divisions**Offset ranges, maximum**Input signal cannot exceed maximum input voltage for the 50 Ω input path.

Volts/div Setting	Maximum offset range, 50 Ω Input
1 mV/div - 99 mV/div	± 1 V
100 mV/div - 1 V/div	± 10 V

Crosstalk (channel isolation), typical $\geq 200:1$ up to the rated bandwidth for any two channels having equal Volts/div settings**DC balance**0.1 div with DC-50 Ω oscilloscope input impedance (50 Ω BNC terminated)0.2 div at 1 mV/div with DC-50 Ω oscilloscope input impedance (50 Ω BNC terminated)0.4 div at 500 μ V/div with DC-50 Ω oscilloscope input impedance (50 Ω BNC terminated)0.2 div with DC-1 M Ω oscilloscope input impedance (50 Ω BNC terminated)0.4 div at 500 μ V/div with DC-1 M Ω scope input impedance (50 Ω BNC terminated)**Vertical system - digital channels****Number of channels**

8 digital inputs (D7-D0) per installed TLP058 (traded off for one analog channel)

Vertical resolution

1 bit

Maximum input toggle rate

500 MHz

Minimum detectable pulse width, typical

300 ps

Thresholds

One threshold per digital channel

Threshold range ± 40 V⁵ Immediately following SPC, add 2% for every 5 $^{\circ}$ C change in ambient.⁶ Immediately following SPC, add 1% for every 5 $^{\circ}$ C change in ambient.

Threshold resolution	10 mV
Threshold accuracy	$\pm [100 \text{ mV} + 3\% \text{ of threshold setting after calibration}]$
Input hysteresis, typical	100 mV at the probe tip
Input dynamic range, typical	30 V _{pp} for F _{in} ≤ 200 MHz, 10 V _{pp} for F _{in} > 200 MHz
Absolute maximum input voltage, typical	±42 V peak
Minimum voltage swing, typical	400 mV peak-to-peak
Input impedance, typical	100 kΩ
Probe loading, typical	2 pF

Horizontal system

Time base range	200 ps/div to 1,000 s/div
Sample rate range	1.5625 S/s to 6.25 GS/s (real time) 12.5 GS/s to 500 GS/s (interpolated)
Record length range	
Standard	1 kpoints to 125 Mpoints in single sample increments
Optional 5-RL-250M	250 Mpoints
Optional 5-RL-500M	500 Mpoints
Aperture uncertainty	$\leq 0.450 \text{ ps} + (1 * 10^{-11} * \text{Measurement Duration})_{\text{RMS}}$, for measurements having duration ≤ 100 ms
Timebase accuracy	$\pm 2.5 \times 10^{-6}$ over any ≥1 ms time interval

Description	Specification
Factory Tolerance	$\pm 5.0 \times 10^{-7}$; at calibration, 23 °C ambient, over any ≥1 ms interval
Temperature stability	$\pm 5.0 \times 10^{-7}$; tested at operating temperatures
Crystal aging	$\pm 1.5 \times 10^{-6}$; frequency tolerance change at 25 °C over a period of 1 year

Delta-time measurement
accuracy, nominal

$$DTA_{pp}(\text{typical}) = 10 \times \sqrt{\left(\frac{N}{SR_1}\right)^2 + \left(\frac{N}{SR_2}\right)^2 + \left(0.450 \text{ ps} + \left(1 \times 10^{-11} \times t_p\right)\right)^2} + TBA \times t_p$$

$$DTA_{RMS} = \sqrt{\left(\frac{N}{SR_1}\right)^2 + \left(\frac{N}{SR_2}\right)^2 + \left(0.450 \text{ ps} + \left(1 \times 10^{-11} \times t_p\right)\right)^2} + TBA \times t_p$$

(assume edge shape that results from Gaussian filter response)

The formula to calculate delta-time measurement accuracy (DTA) for a given instrument setting and input signal assumes insignificant signal content above Nyquist frequency, where:

SR_1 = Slew Rate (1st Edge) around 1st point in measurement

SR_2 = Slew Rate (2nd Edge) around 2nd point in measurement

N = input-referred guaranteed noise limit (V_{RMS})

TBA = time base accuracy or reference frequency error

t_p = delta-time measurement duration (sec)

Maximum duration at highest
sample rate

20 ms (std.) or 80 ms (optional)

Time base delay time range

-10 divisions to 5,000 s

Deskew range

-125 ns to +125 ns with a resolution of 40 ps

Delay between analog channels,
full bandwidth, typical

≤ 100 ps for any two channels with input impedance set to 50 Ω, DC coupling with equal Volts/div or above 10 mV/div

Delay between analog and
digital FlexChannels, typical

< 1 ns when using a TLP058 and a passive probe matching the bandwidth of the scope, with no bandwidth limits applied

Delay between any two digital
FlexChannels, typical

320 ps

Delay between any two bits of a
digital FlexChannel, typical

200 ps

Trigger system

Trigger modes

Auto, Normal, and Single

Trigger coupling DC, HF Reject (attenuates > 50 kHz), LF Reject (attenuates < 50 kHz), noise reject (reduces sensitivity)

Trigger holdoff range 0 ns to 10 seconds

Edge-type trigger sensitivity, DC coupled, typical

Path	Range	Specification
1 M Ω path (all models)	0.5 mV/div to 0.99 mV/div	4.5 div from DC to instrument bandwidth
	≥ 1 mV/div	The greater of 5 mV or 0.7 div from DC to lesser of 500 MHz or instrument BW, & 6 mV or 0.8 div from > 500 MHz to instrument bandwidth
50 Ω path		The greater of 5.6 mV or 0.7 div from DC to the lesser of 500 MHz or instrument BW, & 7 mV or 0.8 div from > 500 MHz to instrument bandwidth
Line		Fixed
AUX Trigger in		200 mV _{PP} , DC to 250 MHz

Trigger jitter, typical

≤ 5 ps_{RMS} for sample mode and edge-type trigger
 ≤ 7 ps_{RMS} for edge-type trigger and FastAcq mode
 ≤ 40 ps_{RMS} for non edge-type trigger modes
 ≤ 40 ps_{RMS} for AUX trigger in, Sample acquisition mode, edge trigger (MSO58LP only)
 ≤ 200 ps_{RMS} for AUX trigger in, Sample acquisition mode, edge trigger (MSO58LP only)
 ≤ 220 ps_{RMS} for AUX trigger in, FastAcq acquisition mode, edge trigger (MSO58LP only)

AUX In trigger skew between instruments, typical

± 100 ps jitter on each instrument with 150 ps skew; ≤ 350 ps total between instruments. With manual deskewing of individual channels, total instrument skew can reach 200 ps between different instrument channels.

Skew improves for sinusoidal input voltages ≥ 500 mV

Trigger level ranges

This specification applies to logic and pulse thresholds.

Source	Range
Any Channel	± 5 divs from center of screen
Aux In Trigger	± 5 V
Line	Fixed at about 50% of line voltage

Trigger types

Edge: Positive, negative, or either slope on any channel. Coupling includes DC, AC, noise reject, HF reject, and LF reject

Pulse Width: Trigger on width of positive or negative pulses. Event can be time- or logic-qualified

Timeout: Trigger on an event which remains high, low, or either, for a specified time period. Event can be logic-qualified

Runt:	Trigger on a pulse that crosses one threshold but fails to cross a second threshold before crossing the first again. Event can be time- or logic-qualified
Window:	Trigger on an event that enters, exits, stays inside or stays outside of a window defined by two user-adjustable thresholds. Event can be time- or logic-qualified
Logic:	Trigger when logic pattern goes true, goes false, or occurs coincident with a clock edge. Pattern (AND, OR, NAND, NOR) specified for all input channels defined as high, low, or don't care. Logic pattern going true can be time-qualified
Setup & Hold:	Trigger on violations of both setup time and hold time between clock and data present on any input channels
Rise / Fall Time:	Trigger on pulse edge rates that are faster or slower than specified. Slope may be positive, negative, or either. Event can be logic-qualified
Video (option 5-VID):	Trigger on all lines, odd, even, or all fields of NTSC, PAL, and SECAM video signals
Sequence:	Trigger on B event X time or N events after A trigger with a reset on C event. In general, A and B trigger events can be set to any trigger type with a few exceptions: logic qualification is not supported, if A event or B event is set to Setup & Hold, then the other must be set to Edge, and Ethernet and High Speed USB (480 Mbps) are not supported
Visual trigger	Qualifies standard triggers by scanning all waveform acquisitions and comparing them to on-screen areas (geometric shapes). An unlimited number of areas can be defined with In, Out, or Don't Care as the qualifier for each area. A boolean expression can be defined using any combination of visual trigger areas to further qualify the events that get stored into acquisition memory. Shapes include rectangle, triangle, trapezoid, hexagon and user-defined.
Parallel Bus:	Trigger on a parallel bus data value. Parallel bus can be from 1 to 64 bits (from the digital and analog channels) in size. Supports Binary and Hex radices
I²C Bus (option 5-SREMBD):	Trigger on Start, Repeated Start, Stop, Address (7 or 10 bit), Data, or Address and Data on I ² C buses up to 10 Mb/s
I³C Bus (option 5-SRI3C)	Trigger on Start, Repeated Start, Stop, Address, Data, I ³ C SDR Direct, I ³ C SDR Broadcast, Missing ACK, T-Bit Error, Broadcast Address Error, Hot-Join, HDR Restart, HDR Exit on I ³ C buses up to 10 Mb/s
SPI Bus (option 5-SREMBD):	Trigger on Slave Select, Idle Time, or Data (1-16 words) on SPI buses up to 20 Mb/s
RS-232/422/485/UART Bus (option 5-SRCOMP):	Trigger on Start Bit, End of Packet, Data, and Parity Error up to 15 Mb/s
CAN Bus (option 5-SRAUTO):	Trigger on Start of Frame, Type of Frame (Data, Remote, Error, or Overload), Identifier, Data, Identifier and Data, End Of Frame, Missing Ack, and Bit Stuff Error on CAN buses up to 1 Mb/s
CAN FD Bus (option 5-SRAUTO):	Trigger on Start of Frame, Type of Frame (Data, Remote, Error, or Overload), Identifier (Standard or Extended), Data (1-8 bytes), Identifier and Data, End Of Frame, Error (Missing Ack, Bit Stuffing Error, FD Form Error, Any Error) on CAN FD buses up to 16 Mb/s
LIN Bus (option 5-SRAUTO):	Trigger on Sync, Identifier, Data, Identifier and Data, Wakeup Frame, Sleep Frame, and Error on LIN buses up to 1 Mb/s
FlexRay Bus (option 5-SRAUTO):	Trigger on Start of Frame, Indicator Bits (Normal, Payload, Null, Sync, Startup), Frame ID, Cycle Count, Header Fields (Indicator Bits, Identifier, Payload Length, Header CRC, and Cycle Count), Identifier, Data, Identifier and Data, End Of Frame, and Errors on FlexRay buses up to 10 Mb/s
SENT Bus (option 5-SRAUTOSEN)	Trigger on Start of Packet, Fast Channel Status and Data, Slow Channel Message ID and Data, and CRC Errors
SPMI Bus (option 5-SRPM):	Trigger on Sequence Start Condition, Reset, Sleep, Shutdown, Wakeup, Authenticate, Master Read, Master Write, Register Read, Register Write, Extended Register Read, Extended Register Write, Extended Register Read Long, Extended Register Write Long, Device Descriptor Block Master Read, Device Descriptor Block Slave Read, Register 0 Write, Transfer Bus Ownership, and Parity Error

USB 2.0 LS/FS/HS Bus (option 5-SRUSB2):	Trigger on Sync, Reset, Suspend, Resume, End of Packet, Token (Address) Packet, Data Packet, Handshake Packet, Special Packet, Error on USB buses up to 480 Mb/s
Ethernet Bus (option 5-SRENET):	Trigger on Start of Frame, MAC Addresses, MAC Q-tag, MAC Length/Type, MAC Data, IP Header, TCP Header, TCP/IPV4 Data, End of Packet, and FCS (CRC) Error on 10BASE-T and 100BASE-TX buses
Audio (I²S, LJ, RJ, TDM) Bus (option 5-SRAUDIO):	Trigger on Word Select, Frame Sync, or Data. Maximum data rate for I ² S/LJ/RJ is 12.5 Mb/s. Maximum data rate for TDM is 25 Mb/s
MIL-STD-1553 Bus (option 5-SRAERO):	Trigger on Sync, Command (Transmit/Receive Bit, Parity, Subaddress / Mode, Word Count / Mode Count, RT Address), Status (Parity, Message Error, Instrumentation, Service Request, Broadcast Command Received, Busy, Subsystem Flag, Dynamic Bus Control Acceptance, Terminal Flag), Data, Time (RT/IMG), and Error (Parity Error, Sync Error, Manchester Error, Non-contiguous Data) on MIL-STD-1553 buses
ARINC 429 Bus (option 5-SRAERO):	Trigger on Word Start, Label, Data, Label and Data, Word End, and Error (Any Error, Parity Error, Word Error, Gap Error) on ARINC 429 buses up to 1 Mb/s
RF Magnitude vs. Time and RF Frequency vs. Time (option 5-SV-RFVT):	Trigger on edge, pulse width and timeout events

Acquisition system

Sample	Acquires sampled values
Peak Detect	Captures glitches as narrow as 640 ps at all sweep speeds
Averaging	From 2 to 10,240 waveforms Maximum averaging speed = 180 waveforms/s
Fast Hardware Averaging	An acquisition mode for acquiring a large number of averages in a short amount of time. Fast hardware averaging optimizes the acquisition path, reducing storage truncation error and smoothing out fine scale non-linearity imperfections via an optional offset dithering technique. This feature is available through programmatic interface commands. From 2 to 1,000,000 waveforms Maximum averaging speed = 32,000 waveforms/s
Envelope	Min-max envelope reflecting Peak Detect data over multiple acquisitions
High Res	Applies a unique Finite Impulse Response (FIR) filter for each sample rate that maintains the maximum bandwidth possible for that sample rate while preventing aliasing and removing noise from the oscilloscope amplifiers and ADC above the usable bandwidth for the selected sample rate. High Res mode always provides at least 12 bits of vertical resolution and extends all the way to 16 bits of vertical resolution at ≤ 125 MS/s sample rates.
FastAcq®	FastAcq optimizes the instrument for analysis of dynamic signals and capture of infrequent events by capturing >500,000 wfms/s (one channel active; >100K wfms/s with all channels active).
Roll mode	Scrolls sequential waveform points across the display in a right-to-left rolling motion, at timebase speeds of 40 ms/div and slower, when in Auto trigger mode.

History mode Makes use of the maximum record length, allowing you to capture many triggered acquisitions, stop when you see something of interest, and quickly review all stored triggered acquisitions. The number of available acquisitions stored in history is (Maximum record length) / (Current record length setting).

FastFrame™ Acquisition memory divided into segments.
 Maximum trigger rate >5,000,000 waveforms per second
 Minimum frame size = 50 points
 Maximum Number of Frames: For frame size $\geq 1,000$ points, maximum number of frames = record length / frame size.
 For 50 point frames, maximum number of frames = 1,000,000

Waveform measurements

Cursor types Waveform, V Bars, H Bars, V&H Bars, and Polar (XY/XYZ plots only)

DC voltage measurement accuracy, Average acquisition mode

Measurement Type	DC Accuracy (In Volts)
Average of ≥ 16 waveforms	$\pm((\text{DC Gain Accuracy}) * \text{reading} - (\text{offset} - \text{position}) + \text{Offset Accuracy} + 0.1 * \text{V/div setting})$
Delta volts between any two averages of ≥ 16 waveforms acquired with the same oscilloscope setup and ambient conditions	$\pm(\text{DC Gain Accuracy} * \text{reading} + 0.05 \text{ div})$

Automatic measurements 36, of which an unlimited number can be displayed as either individual measurement badges or collectively in a measurement results table

Amplitude measurements Amplitude, Maximum, Minimum, Peak-to-Peak, Positive Overshoot, Negative Overshoot, Mean, RMS, AC RMS, Top, Base, and Area

Timing measurements Period, Frequency, Unit Interval, Data Rate, Positive Pulse Width, Negative Pulse Width, Skew, Delay, Rise Time, Fall Time, Phase, Rising Slew Rate, Falling Slew Rate, Burst Width, Positive Duty Cycle, Negative Duty Cycle, Time Outside Level, Setup Time, Hold Time, Duration N-Periods, High Time, Low Time, Time to Minimum, and Time to Maximum

Jitter measurements (standard) TIE and Phase Noise

Measurement statistics Mean, Standard Deviation, Maximum, Minimum, and Population. Statistics are available on both the current acquisition and all acquisitions

Reference levels User-definable reference levels for automatic measurements can be specified in either percent or units. Reference levels can be set to global for all measurements, per source channel or signal, or unique for each measurement

Gating Screen, Cursors, Logic, Search, or Time. Specifies the region of an acquisition in which to take measurements. Gating can be set to Global (affects all measurements set to Global) or Local (all measurements can have a unique Time gate setting; only one Local gate is available for Screen, Cursors, Logic, and Search actions).

Measurement plots Time Trend, Histogram, Spectrum, Eye Diagram (TIE measurement only), and Phase Noise (Phase Noise measurement only) plots are available for all standard measurements

Measurement limits Pass/fail testing for user-definable limits on measurement values. Act on event for measurement value failures include Save Screen Capture, Save Waveform, System Request (SRQ), and Stop Acquisitions

Jitter analysis (option 5-DJA) adds the following:

Measurements Jitter Summary, TJ@BER, RJ- $\delta\delta$, DJ- $\delta\delta$, PJ, RJ, DJ, DDJ, DCD, SRJ, J2, J9, NPJ, F/2, F/4, F/8, Eye Height, Eye Height@BER, Eye Width, Eye Width@BER, Eye High, Eye Low, Q-Factor, Bit High, Bit Low, Bit Amplitude, DC Common Mode, AC Common Mode (Pk-Pk), Differential Crossover, T/nT Ratio, SSC Freq Dev, SSC Modulation Rate

Measurement plots Eye Diagram and Jitter Bathtub
 Fast eye rendering: Shows the Unit Intervals (UIs) that define the boundaries of the eye along with a user specified number of surrounding UIs for added visual context
 Complete eye rendering: Shows all valid Unit Intervals (UIs)

Measurement limits Pass/fail testing for user-definable limits on measurement values. Act on event for measurement value failures include Save Screen Capture, Save Waveform, System Request (SRQ), and Stop Acquisitions

Eye diagram mask testing Automated mask pass/fail testing

Power analysis (option 5-PWR) adds the following:

Measurements Input Analysis (Frequency, V_{RMS} , I_{RMS} , voltage and current Crest Factors, True Power, Apparent Power, Reactive Power, Power Factor, Phase Angle, Harmonics, Inrush Current, Input Capacitance)
 Amplitude Analysis (Cycle Amplitude, Cycle Top, Cycle Base, Cycle Maximum, Cycle Minimum, Cycle Peak-to-Peak)
 Timing Analysis (Period, Frequency, Negative Duty Cycle, Positive Duty Cycle, Negative Pulse Width, Positive Pulse Width)
 Switching Analysis (Switching Loss, dv/dt, di/dt, Safe Operating Area, R_{DSon})

Output Analysis (Line Ripple, Switching Ripple, Efficiency, Turn-on Time, Turn-off Time)

Magnetic Analysis (Inductance, I vs. Intg(V), Magnetic Loss, Magnetic Property)

Frequency Response Analysis (Control Loop Response Bode Plot, Power Supply Rejection Ratio, Impedance)

Measurement Plots Harmonics Bar Graph, Switching Loss Trajectory Plot, and Safe Operating Area

Measurement limits Pass/fail testing for user-definable limits on measurement values. Act on event for measurement value failures include Save Screen Capture, Save Waveform, System Request (SRQ), and Stop Acquisitions

Digital power management (option 5-DPM) adds the following:

Measurements Ripple Analysis (Ripple)
 Transient Analysis (Overshoot, Undershoot, Turn On Overshoot, DC Rail Voltage)

Power Sequence Analysis (Turn-on, Turn-off)
 Jitter Analysis (TIE, PJ, RJ, DJ, Eye Height, Eye Width, Eye High, Eye Low)
 PI/SI Analysis (PSIJ)

Digital Power Management Basic (option 5-DPMBAS) adds the following:

Measurements	Ripple Analysis (Ripple) Transient Analysis (Overshoot, Undershoot) Power Sequence Analysis (Turn-on, Turn-off)
---------------------	---

LVDS debug and analysis option (option 5-DBLVDS) adds the following:

Data Lane Measurements	Generic Test (Unit Interval, Rise Time, Fall Time, Data Width, Data Intra Skew (PN), Data Inter Skew (Lane-to-Lane), Data Peak-to-Peak) Jitter Test (AC Timing, Clock Data Setup Time, Clock Data Hold Time, Eye Diagram (TIE), TJ@BER, DJ Delta, RJ Delta, DDJ, De-Emphasis Level)
Clock Lane Measurements	Generic Test (Frequency, Period, Duty Cycle, Rise Time, Fall Time, Clock Intra Skew (PN), Clock Peak-to-Peak) Jitter Test (TIE, DJ, RJ) SSC On (Mod Rate, Frequency Deviation Mean)

Inverter Motor Drive Analysis (option 5-IMDA) adds the following:

Measurements	Input Analysis (Power Quality, Harmonics, Input Voltage, Input Current, and Input Power), Ripple analysis (Line Ripple and Switching Ripple), Output analysis (Phasor Diagram and Efficiency), DQ0 analysis (DQ0) Requires option 5-IMDA-DQ0
Measurement plots	Harmonics Bar Graph and Phasor Diagram

Inverter Motor Drive Analysis Mechanical Measurements (option 5-IMDA-MECH: requires option 5-IMDA) adds the following:

Sensors supported	Hall sensors, QEI (Quadrature Encoder Interface)
Measurements	Electrical Analysis (Power Quality, Harmonics, Ripple, DQ0, and Efficiency), Mechanical Analysis (Speed, Acceleration, Angle (QEI method), Direction, and Torque)
Measurement plots	Time Trend, Acquisition Trend, Phasor Diagram, Harmonics Bar Graph, DQ0, and Histogram (speed distribution)

Waveform math

Number of math waveforms	Unlimited
---------------------------------	-----------

Arithmetic	Add, subtract, multiply, and divide waveforms and scalars
-------------------	---

Algebraic expressions	Define extensive algebraic expressions including waveforms, scalars, user-adjustable variables, and results of parametric measurements. Perform math on math using complex equations. For example (Integral (CH1 - Mean(CH1)) X 1.414 X VAR1)
------------------------------	---

Math functions	Invert, Integrate, Differentiate, Square Root, Exponential, Log 10, Log e, Abs, Ceiling, Floor, Min, Max, Degrees, Radians, Sin, Cos, Tan, ASin, ACos, and ATan
Relational	Boolean result of comparison >, <, ≥, ≤, =, and ≠
Logic	AND, OR, NAND, NOR, XOR, and EQV
Filtering function (standard)	Loading of user-definable filters. Users specify a file containing the coefficients of the filter.
Filtering function (option 5-UDFLT)	
Filter types	Low pass, High pass, Band pass, Band stop, All pass, Hilbert, Differentiator, and Custom
Filter response types	Butterworth, Chebyshev I, Chebyshev II, Elliptical, Gaussian, and Bessel-Thomson
FFT functions	Spectral Magnitude and Phase, and Real and Imaginary Spectra
FFT vertical units	Magnitude: Linear and Log (dBm) Phase: Degrees, Radians, and Group Delay
FFT window functions	Hanning, Rectangular, Hamming, Blackman-Harris, Flattop2, Gaussian, Kaiser-Bessel, and TekExp
Spectrum View	
Center Frequency	Limited by instrument analog bandwidth
Span	18.6 Hz to 312.5 MHz 18.6 Hz to 500 MHz (with option 5-SV-BW-1) Coarse adjustment in a 1-2-5 sequence
RF Measurements	Channel Power (CHP), Adjacent Channel Power Ratio (ACPR), and Occupied Bandwidth (OBW) measurements on Spectrum View trace data and display
RF vs. Time Traces	Magnitude vs. time, Frequency vs. time, Phase vs. time (with option 5-SV-RFVT)
RF vs. Time Trigger	Edge, pulse width, and timeout trigger on RF Magnitude vs. Time and RF Frequency vs. Time (with option 5-SV-RFVT)
Spectrograms	RF Frequency vs. Time vs. Amplitude display with frequency on x-axis, time on y-axis, and power level indicated by variations in color (with option 5-SV-RFVT)
Resolution Bandwidth (RBW)	93 μHz to 62.5 MHz

93 μ Hz to 100 MHz (with option 5-SV-BW-1)**IQ capture**

The data is stored as in-phase and quadrature (I&Q) samples and precise synchronization is maintained between the time domain data and the I&Q data.

When RF vs. Time traces are activated (with option 5-SV-RFVT), IQ data can be captured and exported to file for more analysis within 3rd party applications.

The max acquisition time varies with span and sample rate. At 6.25 GS/s and 500 MHz span, the max acquisition time is 0.086 seconds. For 312.5 MHz span, the max acquisition time is 0.172 seconds. For 40 MHz span, the max acquisition time is 0.687 seconds. For 1 MHz span, the max acquisition time is 43.980 seconds.

Window types and factors

Window type	Factor
Blackman-Harris	1.90
Flat-Top 2	3.77
Hamming	1.30
Hanning	1.44
Kaiser-Bessel	2.23
Rectangular	0.89

Spectrum Time

FFT Window Factor / RBW

Reference level

Reference level is automatically set by the analog channel Volts/div setting
Setting range: -42 dBm to +44 dBm

Vertical Position

-100 divs to +100 divs

Vertical unitsdBm, dB μ W, dBmV, dB μ V, dBmA, dB μ A**Vertical scaling**

Linear, Log

Horizontal scaling

Linear, Log

Multi-channel spectrum analysis

Each FlexChannel input can be configured with Spectrum View, RF vs. Time traces (with option RFVT), and Spectrogram (with option RFVT).

Multiple RF measurements can be performed simultaneously across channels.

Spectrum Time and Center Frequency settings can be unlocked and moved independently from each other across channels. All Spectrum View channels must share the same Span, Resolution Bandwidth and Window Type.

Search**Number of searches**

Unlimited

Search types Search through long records to find all occurrences of user specified criteria including edges, pulse widths, timeouts, runt pulses, window violations, logic patterns, setup & hold violations, rise/fall times, and bus protocol events. Search results can be viewed in the Waveform View or in the Results table.

Save

Waveform type Tektronix Waveform Data (.wfm), Comma Separated Values (.csv), MATLAB (.mat)

Waveform gating Cursors, Screen, Resample (save every nth sample)

Screen capture type Portable Network Graphic (*.png), 24-bit Bitmap (*.bmp), JPEG (*.jpg)

Setup type Tektronix Setup (.set)

Report type Adobe Portable Documents (.pdf), Single File web Pages (.mht)

Session type Tektronix Session Setup (.tss)

Display (available only through the video out ports or e*Scope)

Display type External monitor

Display resolution 1,920 horizontal × 1,080 vertical pixels (High Definition)

Display modes Overlay: traditional oscilloscope display where traces overlay each other
Stacked: display mode where each waveform is placed in its own slice and can take advantage of the full ADC range while still being visually separated from other waveforms. Groups of channels can also be overlaid within a slice to simplify visual comparison of signals.

Zoom Horizontal and vertical zooming is supported in all waveform and plot views.

Interpolation Sin(x)/x and Linear

Waveform styles Vectors, dots, variable persistence, and infinite persistence

Graticules Movable and fixed graticules, selectable between Grid, Time, Full, and None

Color palettes Normal and inverted for screen captures
Individual waveform colors are user-selectable

Format YT, XY, and XYZ

Local Language User Interface English, Japanese, Simplified Chinese, Traditional Chinese, French, German, Italian, Spanish, Portuguese, Russian, Korean

Local Language Help English, Japanese, Simplified Chinese

Arbitrary-Function Generator (optional)

Function types Arbitrary, sine, square, pulse, ramp, triangle, DC level, Gaussian, Lorentz, exponential rise/fall, $\sin(x)/x$, random noise, Haversine, Cardiac

Sine waveform

Frequency range 0.1 Hz to 50 MHz

Frequency setting resolution 0.1 Hz

Frequency accuracy 130 ppm (frequency \leq 10 kHz), 50 ppm (frequency $>$ 10 kHz)
This is for Sine, Ramp, Square and Pulse waveforms only.

Amplitude range 20 mV_{pp} to 5 V_{pp} into Hi-Z; 10 mV_{pp} to 2.5 V_{pp} into 50 Ω

Amplitude flatness, typical \pm 0.5 dB at 1 kHz
 \pm 1.5 dB at 1 kHz for $<$ 20 mV_{pp} amplitudes

Total harmonic distortion, typical 1% for amplitude \geq 200 mV_{pp} into 50 Ω load
2.5% for amplitude $>$ 50 mV AND $<$ 200 mV_{pp} into 50 Ω load
This is for Sine wave only.

Spurious free dynamic range, typical 40 dB ($V_{pp} \geq 0.1$ V); 30 dB ($V_{pp} \geq 0.02$ V), 50 Ω load

Square and pulse waveform

Frequency range 0.1 Hz to 25 MHz

Frequency setting resolution 0.1 Hz

Frequency accuracy 130 ppm (frequency \leq 10 kHz), 50 ppm (frequency $>$ 10 kHz)

Amplitude range 20 mV_{pp} to 5 V_{pp} into Hi-Z; 10 mV_{pp} to 2.5 V_{pp} into 50 Ω

Duty cycle range 10% - 90% or 10 ns minimum pulse, whichever is larger
Minimum pulse time applies to both on and off time, so maximum duty cycle will reduce at higher frequencies to maintain 10 ns off time

Duty cycle resolution 0.1%

Minimum pulse width, typical 10 ns. This is the minimum time for either on or off duration.

Rise/Fall time, typical 5 ns, 10% - 90%

Pulse width resolution 100 ps

Overshoot, typical $<$ 6% for signal steps greater than 100 mV_{pp}
This applies to overshoot of the positive-going transition (+overshoot) and of the negative-going (-overshoot) transition

Asymmetry, typical	$\pm 1\% \pm 5$ ns, at 50% duty cycle
Jitter, typical	< 60 ps TIE _{RMS} , ≥ 100 mV _{pp} amplitude, 40%-60% duty cycle

Ramp and triangle waveform

Frequency range	0.1 Hz to 500 kHz
Frequency setting resolution	0.1 Hz
Frequency accuracy	130 ppm (frequency ≤ 10 kHz), 50 ppm (frequency > 10 kHz)
Amplitude range	20 mV _{pp} to 5 V _{pp} into Hi-Z; 10 mV _{pp} to 2.5 V _{pp} into 50 Ω
Variable symmetry	0% - 100%
Symmetry resolution	0.1%

DC level range	± 2.5 V into Hi-Z ± 1.25 V into 50 Ω
-----------------------	--

Random noise amplitude range	20 mV _{pp} to 5 V _{pp} into Hi-Z 10 mV _{pp} to 2.5 V _{pp} into 50 Ω
-------------------------------------	---

Sin(x)/x

Maximum frequency	2 MHz
--------------------------	-------

Gaussian pulse, Haversine, and Lorentz pulse

Maximum frequency	5 MHz
--------------------------	-------

Lorentz pulse

Frequency range	0.1 Hz to 5 MHz
Amplitude range	20 mV _{pp} to 2.4 V _{pp} into Hi-Z 10 mV _{pp} to 1.2 V _{pp} into 50 Ω

Cardiac

Frequency range	0.1 Hz to 500 kHz
Amplitude range	20 mV _{pp} to 5 V _{pp} into Hi-Z 10 mV _{pp} to 2.5 V _{pp} into 50 Ω

Arbitrary

Memory depth	1 to 128 k
---------------------	------------

Amplitude range	20 mV _{pp} to 5 V _{pp} into Hi-Z 10 mV _{pp} to 2.5 V _{pp} into 50 Ω
Repetition rate	0.1 Hz to 25 MHz
Sample rate	250 MS/s

Signal amplitude accuracy ±[(1.5% of peak-to-peak amplitude setting) + (1.5% of absolute DC offset setting) + 1 mV] (frequency = 1 kHz)

Signal amplitude resolution 1 mV (Hi-Z)
500 μV (50 Ω)

Sine and ramp frequency accuracy 1.3 x 10⁻⁴ (frequency ≤10 kHz)
5.0 x 10⁻⁵ (frequency >10 kHz)

DC offset range ±2.5 V into Hi-Z
±1.25 V into 50 Ω

DC offset resolution 1 mV (Hi-Z)
500 μV (50 Ω)

DC offset accuracy ±[(1.5% of absolute offset voltage setting) + 1 mV]
Add 3 mV of uncertainty per 10 °C change from 25 °C ambient

Digital volt meter (DVM)

Measurement types DC, AC_{RMS}+DC, AC_{RMS}

Voltage resolution 4 digits

Voltage accuracy

DC: ±((1.5% * |reading - offset - position|) + (0.5% * |(offset - position)|) + (0.1 * Volts/div))
De-rated at 0.100%/°C of |reading - offset - position| above 30 °C
Signal ± 5 divisions from screen center

AC: ± 2% (40 Hz to 1 kHz) with no harmonic content outside 40 Hz to 1 kHz range
AC, typical: ± 2% (20 Hz to 10 kHz)

For AC measurements, the input channel vertical settings must allow the V_{pp} input signal to cover between 4 and 10 divisions and must be fully visible on the screen

Trigger frequency counter

Resolution	8-digits
Accuracy	$\pm(1 \text{ count} + \text{time base accuracy} * \text{input frequency})$ The signal must be at least 8 mV _{pp} or 2 div, whichever is greater.
Maximum input frequency	10 Hz to maximum bandwidth of the analog channel The signal must be at least 8 mV _{pp} or 2 div, whichever is greater.

Processor system

Host processor	Intel x6413E at 1.5 GHz (HFM) / 3.0 GHz (Turbo). Elkhart Lake 4-Core. Intel i5-4400E, 2.7 GHz, 64-bit, dual core processor
Operating system	Default instrument: Closed Linux
Internal storage	≥ 80 GB. Form factor is an 80 mm m.2 card with a SATA-3 interface

Input-Output ports

DisplayPort connector	A 20-pin DisplayPort connector; connect to show the oscilloscope display on an external monitor or projector
DVI connector	A 29-pin DVI-D connector; connect to show the oscilloscope display on an external monitor or projector
VGA	DB-15 female connector; connect to show the oscilloscope display on an external monitor or projector

Probe compensator signal, typical

Connection:	Connectors are located on the lower right front panel of the instrument
Amplitude:	0 to 2.5 V
Frequency:	1 kHz
Source impedance:	1 k Ω

External reference input	The time-base system can phase lock to an external 10 MHz reference signal (± 4 ppm).
USB interface (Host, Device ports)	Front panel USB Host ports: One USB 2.0 Hi-Speed port, one USB 3.0 SuperSpeed port Rear panel USB Device port: One Device port providing USBTMC support
Ethernet interface	10/100/1000 Mb/s
Auxiliary output	Rear-panel BNC connector. Output can be configured to provide a positive or negative pulse out when the oscilloscope triggers, the internal oscilloscope reference clock out, or an AFG sync pulse

Characteristic	Limits
Vout (HI)	≥ 2.5 V open circuit; ≥ 1.0 V into a 50Ω load to ground
Vout (LO)	≤ 0.7 V into a load of ≤ 4 mA; ≤ 0.25 V into a 50Ω load to ground

Aux Trigger In

Connection	Front-panel SMA connector
Input impedance	50Ω
Maximum input	≤ 5 V _{RMS}

Kensington-style lock Rear-panel security slot connects to standard Kensington-style lock

Power source**Power**

Power consumption	400 Watts maximum
Source voltage	100 - 240 V $\pm 10\%$ at 50 Hz to 60 Hz 115 V $\pm 10\%$ at 400 Hz $\pm 10\%$

Physical characteristics

Dimensions	Height: 3.44 in (87.3 mm)
	Width: 17.01 in (432 mm)
	Depth: 23.85 in (605.7 mm)
	Fits rack depths from 24 inches to 32 inches

Weight 25.5 lbs (11.6 kg)

Cooling The clearance requirement for adequate cooling is 2.0 in (50.8 mm) on the left and right sides of the instrument (when viewed from the front). Air flows through the instrument from left to right

Rackmount configuration 2U (rack mounts and screws come standard)

Environmental specifications**Temperature**

Operating	+0 °C to +50 °C (32 °F to 122 °F)
Non-operating	-20 °C to +60 °C (-4 °F to 140 °F)

Humidity

Operating	5% to 90% relative humidity (% RH) at up to +40 °C 5% to 55% RH above +40 °C up to +50 °C, noncondensing, and as limited by a maximum wet-bulb temperature of +39 °C
Non-operating	5% to 90% relative humidity (% RH) at up to +40 °C 5% to 39% RH above +40 °C up to +50 °C, noncondensing, and as limited by a maximum wet-bulb temperature of +39 °C

Altitude

Operating	Up to 3,000 meters (9,843 feet)
Non-operating	Up to 12,000 meters (39,370 feet)

Random vibration

Operating	0.31 GRMS, 5-500 Hz, 10 minutes per axis, 3 axes (30 minutes total)
Non-operating	2.46 GRMS, 5-500 Hz, 10 minutes per axis, 3 axes (30 minutes total)

Temperature

Operating	+0 °C to +50 °C (32 °F to 122 °F)
Non-operating	-20 °C to +60 °C (-4 °F to 140 °F)

Humidity

Operating	5% to 90% relative humidity (% RH) at up to +40 °C 5% to 55% RH above +40 °C up to +50 °C, noncondensing, and as limited by a maximum wet-bulb temperature of +39 °C
Non-operating	5% to 90% relative humidity (% RH) at up to +40 °C 5% to 39% RH above +40 °C up to +50 °C, noncondensing, and as limited by a maximum wet-bulb temperature of +39 °C

Altitude

Operating	Up to 3,000 meters (9,843 feet)
Non-operating	Up to 12,000 meters (39,370 feet)

EMC, Environmental, and Safety

Safety certification	US NRTL Listed - UL61010-1 and UL61010-2-030 Canadian Certification - CAN/CSA-C22.2 No. 61010.1 and CAN/CSA-C22.2 No 61010.2.030 EU Compliance - Low Voltage Directive 2014-35-EU and EN61010-1. International Compliance - IEC 61010-1 and IEC61010-2-030
Regulatory	CE marked for the European Union and UL approved for the USA and Canada

RoHS compliant

Software

IVI driver	Provides a standard instrument programming interface for common applications such as LabVIEW, LabWindows/CVI, Microsoft .NET, and MATLAB. Compatible with Python, C/C++/C# and many other languages through VISA.
e*Scope®	Enables control of the oscilloscope over a network connection through a standard web browser. Simply enter the IP address or network name of the oscilloscope and a web page will be served to the browser. Transfer and save settings, waveforms, measurements, and screen images or make live control changes to settings on the oscilloscope directly from the web browser. Optionally configure e*Scope authentication to password protect access to control and view the oscilloscope.
LXI Web interface	Connect to the oscilloscope through a standard Web browser by simply entering the oscilloscope's IP address or network name in the address bar of the browser. The Web interface enables viewing of instrument status and configuration, status and modification of network settings, and instrument control through the e*Scope web-based remote control.
Programming Examples	Programming with the 4/5/6 Series platforms has never been easier. With a programmers manual and a GitHub site you have many commands and examples to help you get started remotely automating your instrument. See HTTPS://GITHUB.COM/TEKTRONIX/PROGRAMMATIC-CONTROL-EXAMPLES .

Ordering information

Use the following information to select the appropriate instrument and options for your measurement needs.

Step 1

Start by selecting the 5 Series MSO Low Profile model that you need.

Model	Description
MSO58LP BW-1000RL	Low Profile Mixed Signal Oscilloscope; 1 GHz bandwidth, (8) FlexChannels with 125 M record length
MSO58LPGSA BW-1000RL	Low Profile Mixed Signal Oscilloscope; 1 GHz bandwidth, (8) FlexChannels with 125 M record length; Trade Agreements Act (TAA) compliant
MSO58LP BW-500	Low Profile Mixed Signal Oscilloscope; 500 MHz bandwidth, (8) FlexChannels

Each model includes

Rackmount attachments installed
 Installation and safety manual
 Embedded Help
 Power cord
 Calibration certificate documenting traceability to National Metrology Institute(s) and ISO9001/ISO17025 quality system registration
 Three -year warranty covering all parts and labor on the instrument.

Step 2

Add instrument functionality

Instrument functionality can be ordered with the instrument or later as an upgrade kit.

Instrument option	Built-in functionality
5-RL-250M	Extend record length from 125 Mpoints/channel to 250 Mpoints/channel
5-RL-500M	Extend record length from 125 Mpoints/channel to 500 Mpoints/channel
5 -AFG	Add Arbitrary / Function Generator
5-SEC ⁷	Add enhanced security for instrument declassification and password-protected enabling and disabling of all USB ports and firmware upgrade.

Each purchased bundle has two duration options:

- A 1-year subscription includes all features and free upgrades for the purchased bundle for one year; after which time the features are disabled. Additional 1-year subscription can be purchased for the selected bundle.
- A perpetual subscription enables all features for the purchased bundle permanently. A perpetual subscription includes 1-year of free upgrades to the bundle feature set. After the year, the feature set is frozen to those enabled by the last update made.

Perpetual bundles can continue to receive upgrades following the 1 year activation period with the purchase of a maintenance license. Maintenance license information can be found in the maintenance license table below and must be purchased for an existing Starter, Pro, or Ultimate bundle.

⁷ This option must be purchased at the same time as the instrument. Not available as an upgrade.

Maintenance license	Description
5-STARTER-MNT-1Y	Includes Perpetual Starter Bundle updates for 1 Year on 5 Series MSO
5-PRO-MNT-1Y	Includes Perpetual Pro Bundle updates for 1 Year on 5 Series MSO
5-ULTIMATE-MNT-1Y	Includes Perpetual Ultimate Bundle updates for 1 Year on 5 Series MSO

Step 3

Add optional serial bus triggering, decode, and search capabilities

Choose the serial support you need today by choosing from these serial analysis options. You can upgrade later by purchasing an upgrade kit.

Instrument Option	Serial Buses Supported
5-RFNFC	ISO/IEC 15693, 14443A, 14443B, and FeliCa (decode and search only)
5-SRAERO	Aerospace (MIL-STD-1553, ARINC 429)
5-SRAUDIO	Audio (I ² S, LJ, RJ, TDM)
5-SRAUTO	Automotive (CAN, CAN FD, LIN, FlexRay, and CAN symbolic decoding)
5-SRAUTOSEN	Automotive sensor (SENT)
5-SRCOMP	Computer (RS-232/422/485/UART)
5-SRCXPI	CXPI (decode and search only)
5-SRDPHY	MIPI D-PHY (DSI-1, CSI-2 decode and search only)
5-SREMBD	Embedded (I ² C, SPI)
5-SRENET	Ethernet (10BASE-T, 100BASE-TX)
5-SRESPI	eSPI (decode and search only)
5-SRI3C	MIPI I3C
5-SRETHERCAT	EtherCAT (decode and search only)
5-SRMDIO	MDIO (decode and search only)
5-SRPM	Power Management (SPMI)
5-SRPSI5	PSI5 (decode and search only)
5-SRSDLC	Synchronous Data Link Control Protocol Decode & Search
5-SRSMBUS	SMBus (decode and search only)
5-SRSPACEWIRE	Spacewire (decode and search only)
5-SRVID	SVID
5-SRUSB2	USB (USB2.0 LS, FS, HS)
5-SREUSB2	eUSB2.0 (decode and search only)

Differential serial bus? Be sure to check *Add analog probes and adapters* for differential probes.

Step 4

Add optional analysis capabilities

Instrument option	Advanced analysis
5-DJA	Advanced Jitter and Eye Analysis
5-DPM	Digital Power Management
5-DPMBAS	Basic Digital Power Management
5-MTM	Mask and Limit testing
5-PS2 ^{8 9}	Power Solution Bundle (5-PWR, THDP0200, TCP0030A, 067-1686-xx deskew fixture)
5-PS2FRA ^{8 9}	Power Solution Bundle (5-PWR, THDP0200, TCP0030A, two TPP0502, 067-1686-xx deskew fixture)
5 -PWR ¹⁰	Power Measurement and Analysis
5-SV-BW-1	Increase Spectrum View Capture Bandwidth to 500 MHz
5-SV-RFVT	Spectrum View RF vs. Time traces, triggers, Spectrograms, and IQ capture
5-UDFLT	User Defined Filter Creation Tool
5-VID	NTSC, PAL, and SECAM video triggering

Step 5

Add analog probes and adapters

Add additional recommended probes and adapters

Recommended Probe / Adapter	Description
TAP1500	1.5 GHz TekVPI® active single-ended voltage probe, ±8 V input voltage
TAP2500	2.5 GHz TekVPI® active single-ended voltage probe, ±4 V input voltage
TCP0030A	30 A AC/DC TekVPI® current probe, 120 MHz BW
TCP0020	20 A AC/DC TekVPI® current probe, 50 MHz BW
TCP0030A	30 A AC/DC TekVPI current probe, 120 MHz BW
TCP0150	150 A AC/DC TekVPI® current probe, 20 MHz BW
TRCP0300	30 MHz AC current probe, 250 mA to 300 A
TRCP0600	30 MHz AC current probe, 500 mA to 600 A
TRCP3000	16 MHz AC current probe, 500 mA to 3000 A
TDP0500	500 MHz TekVPI® differential voltage probe, ±42 V differential input voltage
TDP1000	1 GHz TekVPI® differential voltage probe, ±42 V differential input voltage
TDP1500	1.5 GHz TekVPI® differential voltage probe, ±8.5 V differential input voltage
TDP7704	4 GHz TriMode™ voltage probe
TDP7710	10 GHz TriMode™ voltage probe

Table continued...

⁸ This option is not compatible with option 5-PWR.

⁹ This option must be purchased at the same time as the instrument. Not available as an upgrade.

Recommended Probe / Adapter	Description
THDP0100	±6 kV, 100 MHz TekVPI® high-voltage differential probe
THDP0200	±1.5 kV, 200 MHz TekVPI® high-voltage differential probe
TMDP0200	±750 V, 200 MHz TekVPI® high-voltage differential probe
TPR1000	1 GHz, Single-Ended TekVPI® Power-Rail Probe; includes one TPR4KIT accessory kit
TIVP02	Isolated Probe; 200 MHz, ±5 V to ±2500 V depending on tip; 2 meter cable
TIVP02L	Isolated Probe; 200 MHz, ±5 V to ±2500 V depending on tip; 10 meter cable
TIVP05	Isolated Probe; 500 MHz, ±5 V to ±2500 V depending on tip; 2 meter cable
TIVP05L	Isolated Probe; 500 MHz, ±5 V to ±2500 V depending on tip; 10 meter cable
TIVP1	Isolated Probe; 1 GHz, ±5 V to ±2500 V depending on tip; 2 meter cable
TIVP1L	Isolated Probe; 1 GHz, ±5 V to ±2500 V depending on tip; 10 meter cable
TPP0500B	500 MHz, 10X TekVPI® passive voltage probe, 1.3 Meter Cable
TPP0502	500 MHz, 2X TekVPI® passive voltage probe, 12.7 pF input capacitance
TPP0850	2.5 kV, 800 MHz, 50X TekVPI® passive high-voltage probe
TPP1000	1 GHz, 10X TekVPI® passive voltage probe, 1.3 Meter cable, 3.9 pF input capacitance
P6015A	20 kV, 75 MHz high-voltage passive probe
TPA-BNC	TekVPI® to TekProbe™ BNC adapter (recommended for connecting your existing TekProbe probes to this instrument)
TEK-DPG	TekVPI deskew pulse generator signal source
067-1686-xx	Power measurement deskew and calibration fixture

Looking for other probes? Check out the probe selector tool at www.tek.com/probes.

Step 6

Add digital probes

Each FlexChannel input can be configured as eight digital channels simply by connecting a TLP058 logic probe to a FlexChannel input.. TLP058 probes are ordered separately.

For this instrument	Order	To add
MSO58LP, MSO58LPGSA	1 to 8 TLP058 Probes	8 to 64 digital channels

Step 7

Add accessories

Optional Accessory	Description
020-3180-xx	Benchtop conversion kit including four (4) instrument feet and a strap handle
016-2139-xx	Hard transit case with handles and wheels for easy transportation
Table continued...	

¹⁰ This option is not compatible with option 5-PS2 or 5-PS2FRA.

Optional Accessory	Description
GPIB to Ethernet adapter	Order model 4865B (GPIB to Ethernet to Instrument Interface) directly from ICS Electronics www.icselect.com/gpib_instrument_intfc.html

Step 8

Select power cord option

Power Cord Option	Description
A0	North America power plug (115 V, 60 Hz) Includes mechanism that retains power cord to instrument
A1	Universal Euro power plug (220 V, 50 Hz)
A2	United Kingdom power plug (240 V, 50 Hz)
A3	Australia power plug (240 V, 50 Hz)
A5	Switzerland power plug (220 V, 50 Hz)
A6	Japan power plug (100 V, 50/60 Hz)
A10	China power plug (50 Hz)
A11	India power plug (50 Hz)
A12	Brazil power plug (60 Hz)
A99	No power cord

Step 9

Add extended service and calibration options

Service Option	Description
T3	Three-year Total Protection Plan, includes repair or replacement coverage from wear and tear, accidental damage, ESD or EOS.
R3	Standard warranty extended to 3 years. Covers parts, labor and 2-day shipping within country. Guarantees faster repair time than without coverage. All repairs include calibration and updates. Hassle free - a single call starts the process.
C3	Calibration service for 3 years. Includes traceable calibration or functional verification where applicable, for recommended calibrations. Coverage includes the initial calibration plus 2 years of calibration coverage.
T5	Five year Total Protection Plan, includes repair or replacement coverage from wear and tear, accidental damage, ESD or EOS.
R5	Standard warranty extended to 5 years. Covers parts, labor and 2-day shipping within country. Guarantees faster repair time than without coverage. All repairs include calibration and updates. Hassle free - a single call starts the process.
Table continued...	

Service Option	Description
C5	Calibration service for 5 years. Includes traceable calibration or functional verification where applicable, for recommended calibrations. Coverage includes the initial calibration plus 4 years of calibration coverage.

Feature upgrades after purchase

Add feature upgrades in the future

You can easily add functionality after the initial purchase. Node-locked licenses permanently enable optional features on a single product. Floating licenses allow license-enabled options to be easily moved between compatible instruments.

Upgrade feature	Node-locked license upgrade	Floating license upgrade	Description
Add instrument functions	SUP5-AFG	SUP5-AFG-FL	Add arbitrary function generator
	SUP5-RL-125MT250M	SUP5-RL-125MT250M-FL	Extend record length from 125 Mpts to 250 Mpts
	SUP5-RL-125MT500M	SUP5-RL-125MT500M-FL	Extend record length from 125 Mpts to 500 Mpts
	SUP5-RL-250MT500M	SUP5-RL-250MT500M-FL	Extend record length from 250 Mpts to 500 Mpts

Table continued...

Upgrade feature	Node-locked license upgrade	Floating license upgrade	Description
Add protocol analysis	SUP5-RFNFC	SUP5-RFNFC-FL	ISO/IEC 15693, 14443A, 14443B, and FeliCa (decode and search only)
	SUP5-SRAERO	SUP5-SRAERO-FL	Aerospace serial triggering and analysis (MIL-STD-1553, ARINC 429)
	SUP5-SRAUDIO	SUP5-SRAUDIO-FL	Audio serial triggering and analysis (I ² S, LJ, RJ, TDM)
	SUP5-SRAUTO	SUP5-SRAUTO-FL	Automotive serial triggering and analysis (CAN, CAN FD, LIN, FlexRay, and CAN symbolic decoding)
	SUP5-SRAUTOSEN	SUP5-SRAUTOSEN-FL	Automotive sensor serial triggering and analysis (SENT)
	SUP5-SRCOMP	SUP5-SRCOMP-FL	Computer serial triggering and analysis (RS-232/422/485/UART)
	SUP5-SRCXPI	SUP5-SRCXPI-FL	CXPI serial decoding and analysis
	SUP5-SRDPHY	SUP5-SRDPHY-FL	MIPI D-PHY (DSI-1, CSI-2 decode and search only)
	SUP5-SREMBD	SUP5-SREMBD-FL	Embedded serial triggering and analysis (I ² C, SPI)
	SUP5-SRENET	SUP5-SRENET-FL	Ethernet serial triggering and analysis (10Base-T, 100Base-TX)
	SUP5-SRESPI	SUP5-SRESPI-FL	eSPI serial decoding and analysis
	SUP5-SRETHERCAT	SUP5-SRETHERCAT-FL	EtherCAT serial decoding and analysis
	SUP5-SRI3C	SUP5-SRI3C-FL	MIPI I3C serial triggering and analysis
	SUP5-SRMDIO	SUP5-SRMDIO-FL	Management Data Input/Output serial decoding and analysis
	SUP5-SRPM	SUP5-SRPM-FL	Power Management serial triggering and analysis (SPMI)
	SUP5-SRPSI5	SUP5-SRPSI5-FL PSI5	Serial decoding and analysis
	SUP5-SRSDLC	SUP5-SRSDLC-FL	Synchronous Data Link Control Protocol (decode and search only)
	SUP5-SRSMBUS	SUP5-SRSMBUS-FL	SMBus serial decoding and analysis
	SUP5-SRSPACEWIRE	SUP5-SRSPACEWIRE-FL	Spacewire serial analysis
	SUP5-SRSVID	SUP5-SRSVID-FL	Serial Voltage Identification (SVID) serial triggering and analysis
SUP5-SRUSB2	SUP5-SRUSB2-FL	USB 2.0 serial bus triggering and analysis (LS, FS, and HS)	
SUP5-SREUSB2	SUP5-SREUSB2-FL	Embedded USB2 (eUSB2) serial decoding and analysis	

Table continued...

Upgrade feature	Node-locked license upgrade	Floating license upgrade	Description
Add advanced analysis	SUP5-DJA	SUP5-DJA-FL	Advanced jitter and eye analysis
	SUP5-DPM	SUP5-DPM-FL	Digital Power Management
	SUP5-MTM	SUP5-MTM-FL	Mask and Limit Testing
	SUP5-DPMBAS	SUP5-DPMBAS-FL	Basic digital power management
	SUP5-PWR	SUP5-PWR-FL	Advanced power measurements and analysis
	SUP5-SV-BW-1	SUP5-SV-BW-1-FL	Increase Spectrum View Capture Bandwidth to 500 MHz
	SUP5-SV-RFVT	SUP5-SV-RFVT-FL	Spectrum View RF vs. Time traces, triggers, Spectrograms, and IQ capture
	SUP5-UDFLT	SUP5-UDFLT-FL	User Defined Filter Creation Tool
	SUP5-VID	SUP5-VID-FL	NTSC, PAL, and SECAM video triggering
Add digital voltmeter	N/A	N/A	Add digital voltmeter / trigger frequency counter (Free with product registration at www.tek.com/register4mso)



Tektronix is ISO 14001:2015 and ISO 9001:2015 certified by DEKRA.

ASEAN / Australasia (65) 6356 3900
 Belgium 00800 2255 4835*
 Central East Europe and the Baltics +41 52 675 3777
 Finland +41 52 675 3777
 Hong Kong 400 820 5835
 Japan 81 (120) 441 046
 Middle East, Asia, and North Africa +41 52 675 3777
 People's Republic of China 400 820 5835
 Republic of Korea +82 2 565 1455
 Spain 00800 2255 4835*
 Taiwan 886 (2) 2656 6688

Austria 00800 2255 4835*
 Brazil +55 (11) 3759 7627
 Central Europe & Greece +41 52 675 3777
 France 00800 2255 4835*
 India 000 800 650 1835
 Luxembourg +41 52 675 3777
 The Netherlands 00800 2255 4835*
 Poland +41 52 675 3777
 Russia & CIS +7 (495) 6647564
 Sweden 00800 2255 4835*
 United Kingdom & Ireland 00800 2255 4835*

Balkans, Israel, South Africa and other ISE Countries +41 52 675 3777
 Canada 1 800 833 9200
 Denmark +45 80 88 1401
 Germany 00800 2255 4835*
 Italy 00800 2255 4835*
 Mexico, Central/South America & Caribbean 52 (55) 56 04 50 90
 Norway 800 16098
 Portugal 80 08 12370
 South Africa +41 52 675 3777
 Switzerland 00800 2255 4835*
 USA 1 800 833 9200

* European toll-free number. If not accessible, call: +41 52 675 3777

For Further Information. Tektronix maintains a comprehensive, constantly expanding collection of application notes, technical briefs and other resources to help engineers working on the cutting edge of technology. Please visit www.tek.com.

Copyright © Tektronix, Inc. All rights reserved. Tektronix products are covered by U.S. and foreign patents, issued and pending. Information in this publication supersedes that in all previously published material. Specification and price change privileges reserved. TEKTRONIX and TEK are registered trademarks of Tektronix, Inc. All other trade names referenced are the service marks, trademarks, or registered trademarks of their respective companies.



**Ihr Ansprechpartner /
Your Partner:**

dataTec AG
 E-Mail: info@datatec.eu
 >>> www.datatec.eu

20 Mar 2024 48W-61275-20
tek.com

Tektronix®