

# E5061B ENA Vector Network Analyzer

100 kHz to 1.5/3 GHz  
5 Hz to 500 M/1.5 G/3 GHz



## Definitions

All specifications apply over a 23 °C ± 5 °C range (unless otherwise stated) and 90 minutes after the instrument has been turned on.

### Specification (spec.)

Warranted performance. Specifications include guardbands to account for the expected statistical performance distribution, measurement uncertainties, and changes in performance due to environmental conditions.

Supplemental information is intended to provide information that is helpful for using the instrument but that is not guaranteed by the product warranty.

### Typical (typ.)

Describes performance that will be met by a minimum of 80% of all products. It is not guaranteed by the product warranty.

### Supplemental performance data (SPD)

Represents the value of a parameter that is most likely to occur; the expected mean or average. It is not guaranteed by the product warranty.

### General characteristics

A general, descriptive term that does not imply a level of performance.

### Boundary Conditions

If the same boundary conditions fall under more than one category in the table, apply the best value.

## E5061B Test Set Options

### 50 Ω RF NA options

E5061B-115	Transmission/Reflection test set, 100 kHz to 1.5 GHz, 50 Ω system impedance
------------	-----------------------------------------------------------------------------

E5061B-215	S-parameter test set, 100 kHz to 1.5 GHz, 50 Ω system impedance
------------	-----------------------------------------------------------------

E5061B-135	Transmission/Reflection test set, 100 kHz to 3 GHz, 50 Ω system impedance
------------	---------------------------------------------------------------------------

E5061B-235	S-parameter test set, 100 kHz to 3 GHz, 50 Ω system impedance
------------	---------------------------------------------------------------

### 75 Ω RF NA options

E5061B-117	Transmission/Reflection test set, 100 kHz to 1.5 GHz, 75 Ω system impedance
------------	-----------------------------------------------------------------------------

E5061B-217	S-parameter test set, 100 kHz to 1.5 GHz, 75 Ω system impedance
------------	-----------------------------------------------------------------

E5061B-137	Transmission/Reflection test set, 100 kHz to 3 GHz, 75 Ω system impedance
------------	---------------------------------------------------------------------------

E5061B-237	S-parameter test set, 100 kHz to 3 GHz, 75 Ω system impedance
------------	---------------------------------------------------------------

### LF-RF NA option

E5061B-3L3	LF-RF network analyzer with DC bias source, 5 Hz to 500 MHz
------------	-------------------------------------------------------------

E5061B-3L4	LF-RF network analyzer with DC bias source, 5 Hz to 1.5 GHz
------------	-------------------------------------------------------------

E5061B-3L5	LF-RF network analyzer with DC bias source, 5 Hz to 3 GHz
------------	-----------------------------------------------------------

# S-Parameter Measurement

## Corrected system performance

The specifications in this section apply for measurements made with the Keysight Technologies, Inc. E5061B ENA vector network analyzer with the following conditions:

- No averaging applied to data
- Environmental temperature of  $23\text{ °C} \pm 5\text{ °C}$ , with less than  $1\text{ °C}$  deviation from the calibration temperature
- Response and isolation calibration not omitted

Table 1. System dynamic range <sup>1,2</sup>

Description	Specification	SPD
<b>System dynamic range</b>		
(Option 3L3/3L4/3L5)		
100 kHz to 1 MHz, 3 kHz IF bandwidth	90 dB	
1 MHz to 3 GHz, 3 kHz IF bandwidth	95 dB	
5 to 100 Hz, 2Hz IF bandwidth	90 dB	
100 Hz to 9 kHz, 10 Hz IF bandwidth	100 dB	
9 to 100 kHz, 10 Hz IF bandwidth	110 dB	
100 kHz to 1 MHz, 10 Hz IF bandwidth	115 dB	
1 MHz to 3 GHz, 10 Hz IF bandwidth	120 dB	130 dB
(Option 115, 135, 215, 235, 117, 137, 217, 237)		
100 to 300 kHz, 3 kHz IF bandwidth	75 dB	
300 kHz to 1 MHz, 3 kHz IF bandwidth	90 dB	
1 MHz to 3 GHz, 3 kHz IF bandwidth	95 dB	
100 to 300 kHz, 10 Hz IF bandwidth	100 dB	
300 kHz to 1 MHz, 10 Hz IF bandwidth	115 dB	
1 MHz to 3 GHz, 10 Hz IF bandwidth	120 dB	130 dB

1. The test port dynamic range is calculated as the difference between the test port rms noise floor and the source maximum output power. The effective dynamic range must take measurement uncertainty and interfering signals into account.
2. The specification might not be met at the frequencies 1.4 MHz, 4.0 MHz, 4.333 MHz, 6.167 MHz, 6.333 MHz, 25 MHz and 90 MHz.

Table 2. Corrected system performance with Type-N 50 Ω connectors, 85032F calibration kit, full 2-port calibration

Network analyzer: E5061B-3L3/3L4/3L5, calibration kit: 85032F (Type-N, 50 Ω), calibration: full 2-port  
 IF bandwidth = 10 Hz, No averaging applied to data, environmental temperature = 23 °C ± 5 °C with < 1 °C deviation from calibration temperature, isolation calibration not omitted

Description	Specification (dB)		
	100 Hz to 100 kHz	100 kHz to 1 GHz	1 GHz to 3 GHz
Directivity	49	49	46
Source match	41	41	40
Load match	49	49	46
Reflection tracking	0.011	0.011	0.021
Transmission tracking	0.019	0.019	0.026

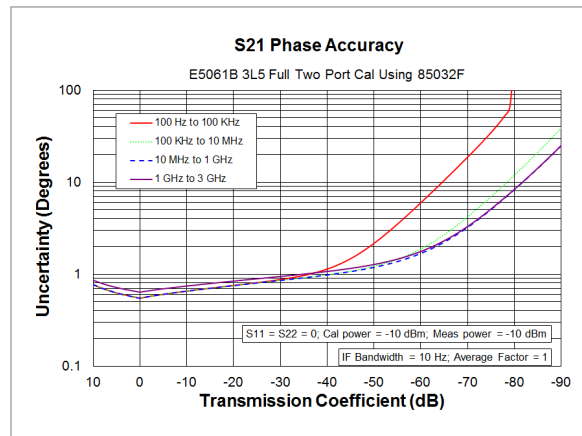
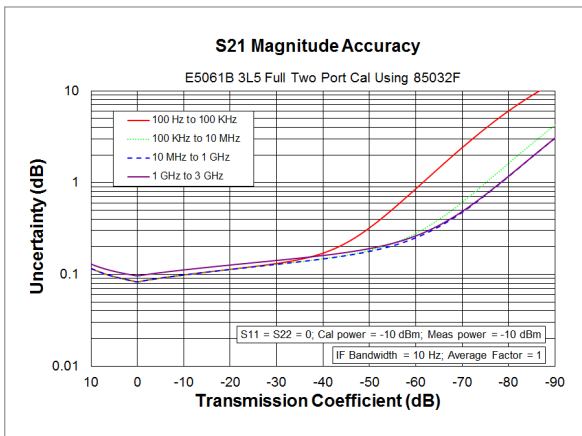

Figure 1. Transmission uncertainty (specification)

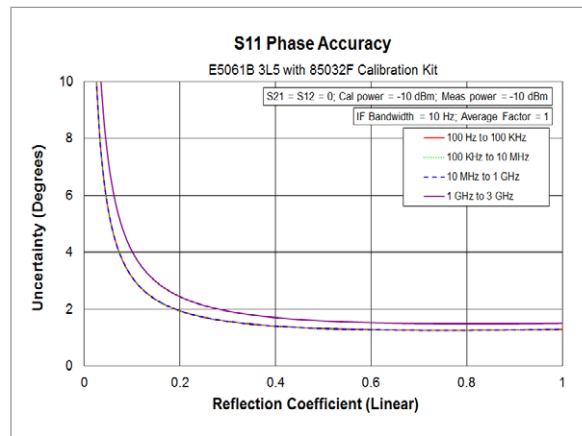
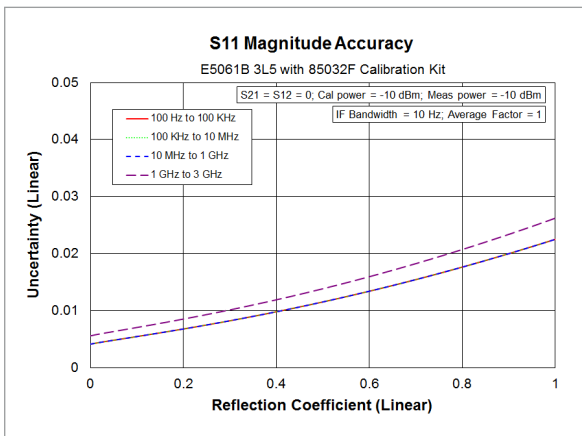

Figure 2. Reflection uncertainty (specification)

Table 3. Corrected system performance with Type-N 50 Ω connectors, 85032F calibration kit, enhanced response calibration

Network analyzer: E5061B-3L3/3L4/3L5, calibration kit: 85032F (Type-N, 50 Ω), calibration: enhanced response

IF bandwidth = 10 Hz, No averaging applied to data, environmental temperature = 23 °C ± 5 °C with < 1 °C deviation from calibration temperature, isolation calibration not omitted

Description	Specification (dB)		
	100 Hz to 100 kHz	100 kHz to 1 GHz	1 GHz to 3 GHz
Directivity	49	49	46
Source match	41	41	40
Load match	49	49	46
Reflection tracking	0.011	0.011	0.021
Transmission tracking	0.019	0.019	0.033

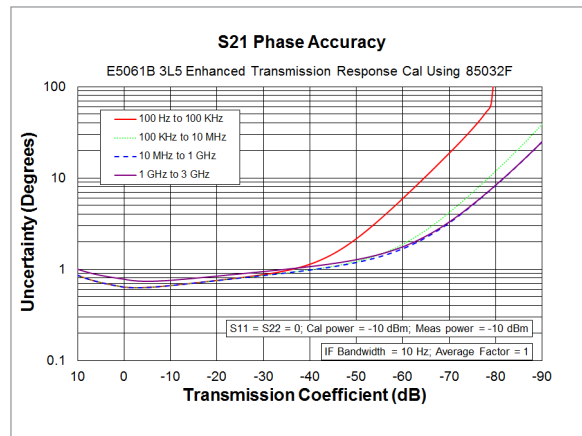
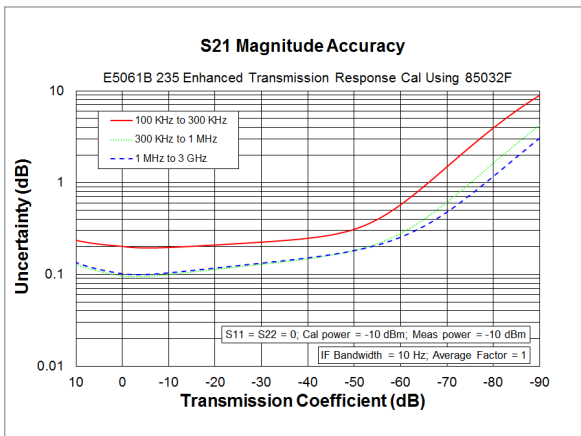

Figure 3. Transmission uncertainty (specification)

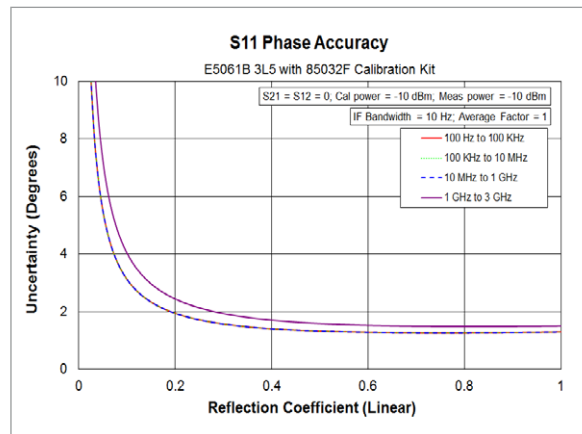
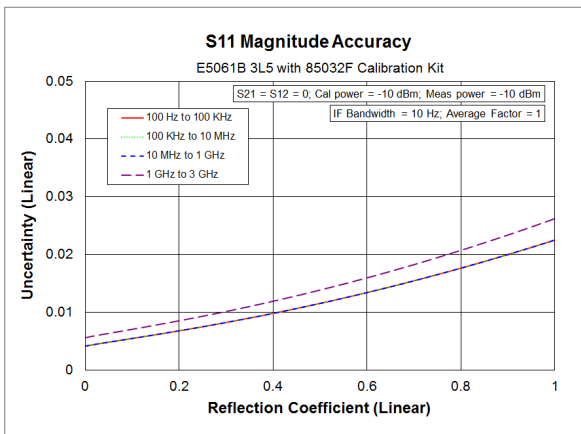

Figure 4. Reflection uncertainty (specification)

Table 4. Corrected system performance with Type-N 50 Ω connectors, 85092C ECal Module, full 2-port calibration

Network analyzer: E5061B-3L3/3L4/3L5, calibration kit: 85092C (Type-N, 50 Ω 300 kHz to 9 GHz), calibration: Full 2 port

IF bandwidth = 10 Hz, No averaging applied to data, environmental temperature = 23 °C ± 5 °C with < 1 °C deviation from calibration temperature, isolation calibration not omitted

Description	Specification (dB)		
	300 kHz to 10 MHz	10 MHz to 1 GHz	1 GHz to 3 GHz
Directivity	45	52	52
Source match	36	45	44
Load match	37	42	45
Reflection tracking	0.100	0.040	0.040
Transmission tracking	0.084	0.031	0.051

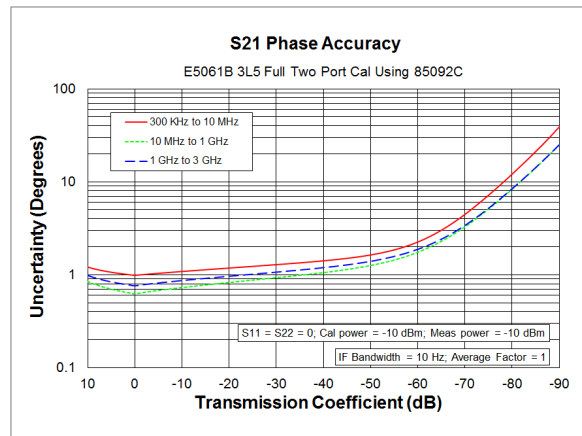
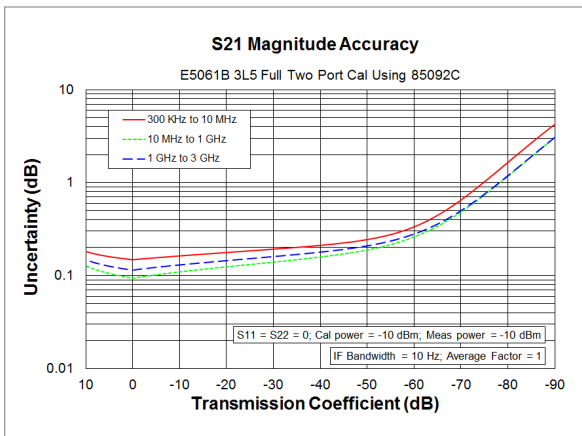

Figure 5. Transmission uncertainty (specification)

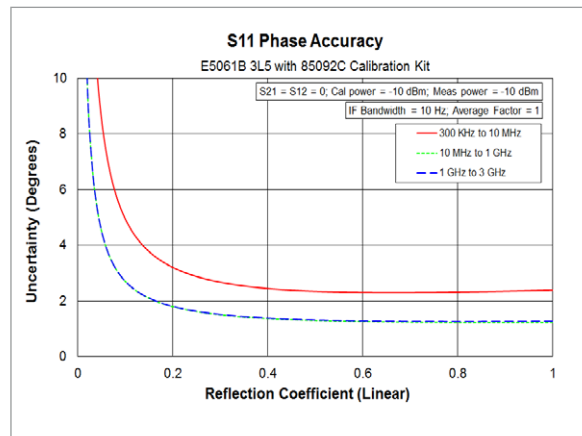
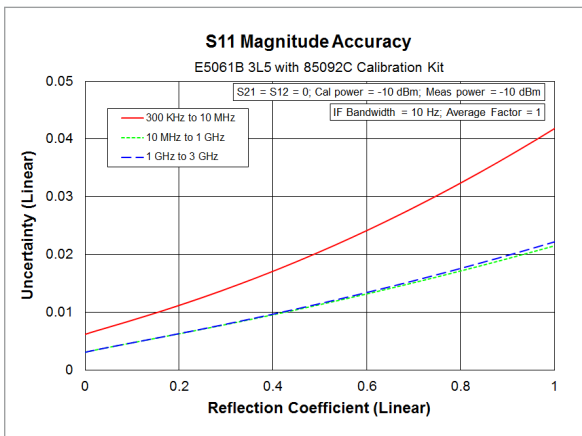

Figure 6. Reflection uncertainty (specification)

Table 5. Corrected system performance with Type-N 50 Ω connectors, 85032F calibration kit, full 2-port calibration

Network analyzer: E5061B-115/135/215/235, calibration kit: 85032F (Type-N, 50 Ω), calibration: Full 2 port

IF bandwidth = 10 Hz, No averaging applied to data, environmental temperature = 23 °C ± 5 °C with < 1 °C deviation from calibration temperature, isolation calibration not omitted

Description	Specification (dB)		
	100 kHz to 300 kHz	300 kHz to 1 MHz	1 MHz to 3 GHz
Directivity	49	49	46
Source match	41	41	40
Load match	48	49	46
Reflection tracking	0.011	0.011	0.021
Transmission tracking	0.035	0.028	0.034

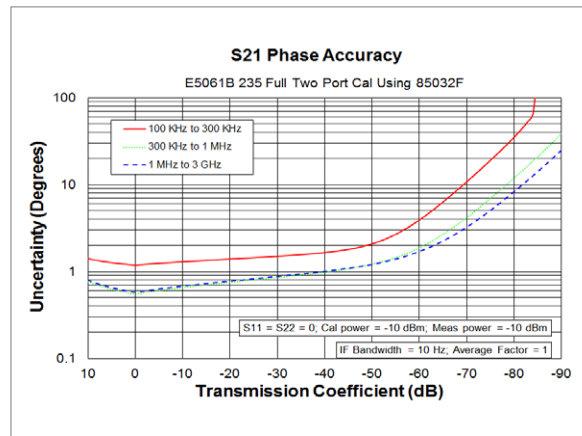
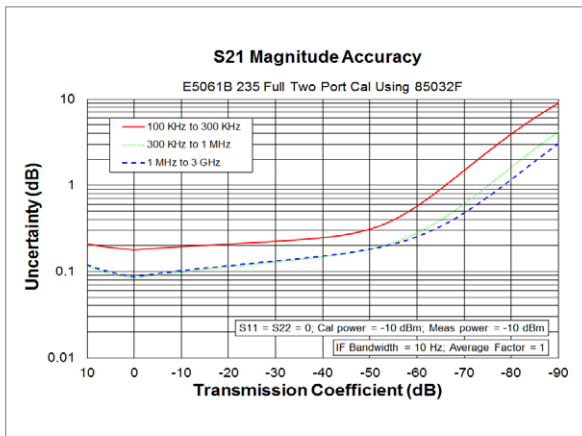

Figure 7. Transmission uncertainty (specification)

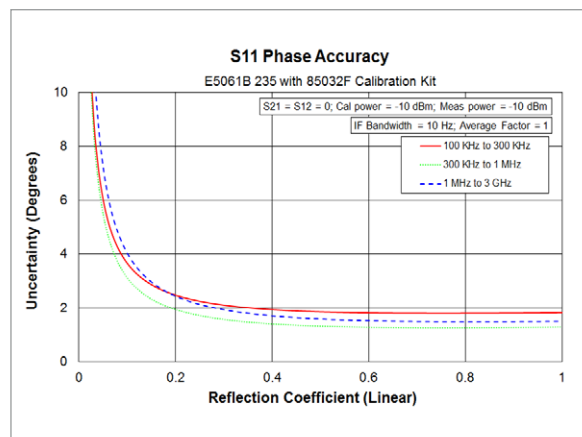
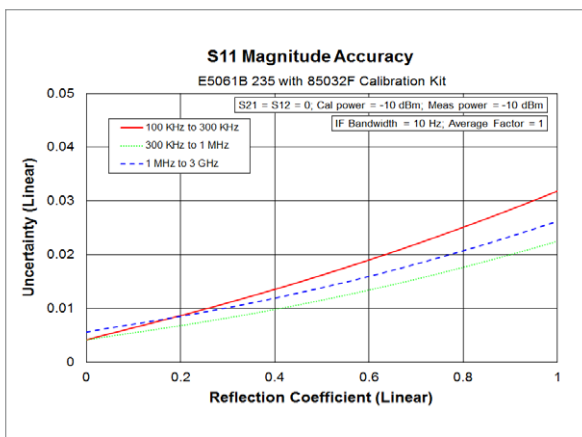

Figure 8. Reflection uncertainty (specification)

Table 6. Corrected system performance with Type-N 50 Ω connectors, 85032F calibration kit, enhanced response calibration

Network analyzer: E5061B-115/135/215/235, calibration kit: 85032F (Type-N, 50 Ω), calibration: enhanced response calibration

IF bandwidth = 10 Hz, No averaging applied to data, environmental temperature = 23 °C ± 5 °C with < 1 °C deviation from calibration temperature, isolation calibration not omitted

Description	Specification (dB)		
	100 kHz to 300 kHz	300 kHz to 1 MHz	1 MHz to 3 GHz
Directivity	49	49	46
Source match	41	41	40
Load match	48	49	46
Reflection tracking	0.011	0.011	0.021
Transmission tracking	0.035	0.028	0.034

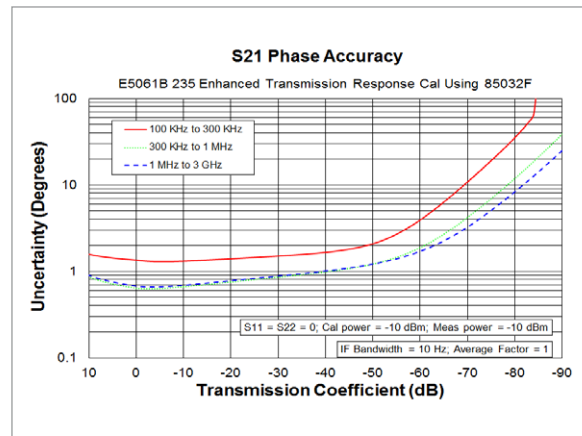
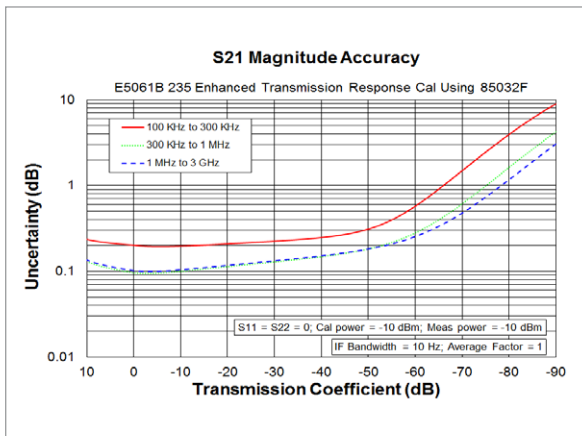

Figure 9. Transmission uncertainty (specification)

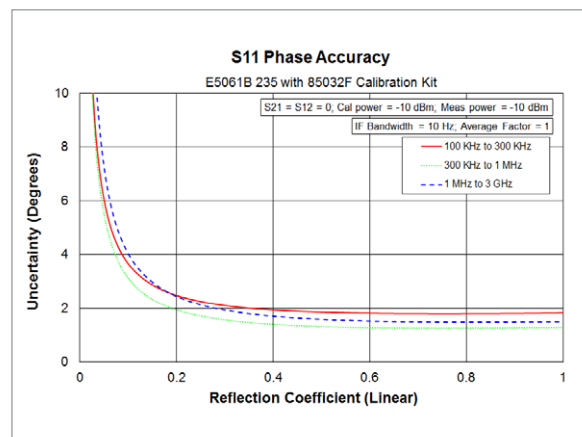
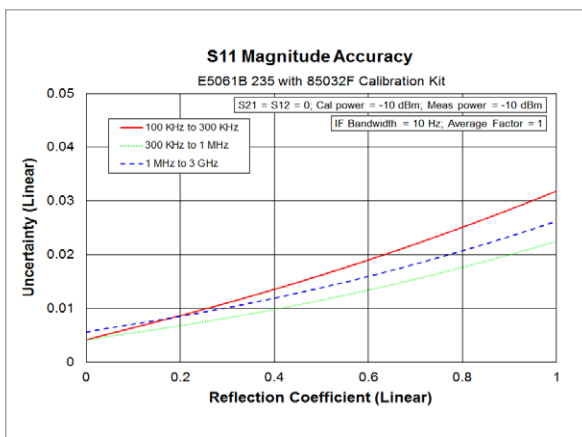

Figure 10. Reflection uncertainty (specification)



Table 7. Corrected system performance with Type-N 50 Ω connectors, 85092C ECal Module, full 2-port calibration

Network analyzer: E5061B-115/135/215/235, calibration kit: 85092C (Type-N, 50 Ω), calibration: Full 2 port

IF bandwidth = 10 Hz, No averaging applied to data, environmental temperature = 23 °C ± 5 °C with < 1 °C deviation from calibration temperature, isolation calibration not omitted

Description	Specification (dB)	
	300 kHz to 1 MHz	1 MHz to 3 GHz
Directivity	45	45
Source match	36	36
Load match	37	37
Reflection tracking	0.1	0.1
Transmission tracking	0.084	0.081

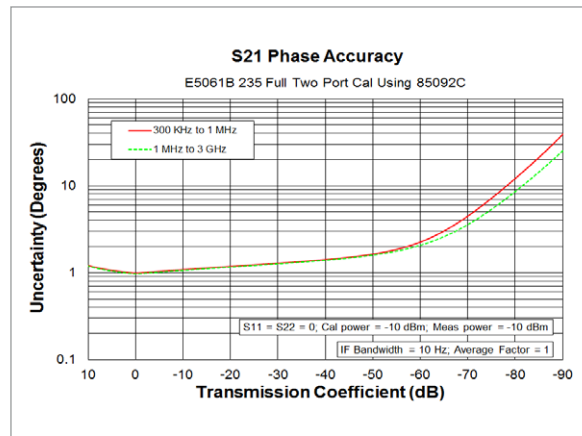
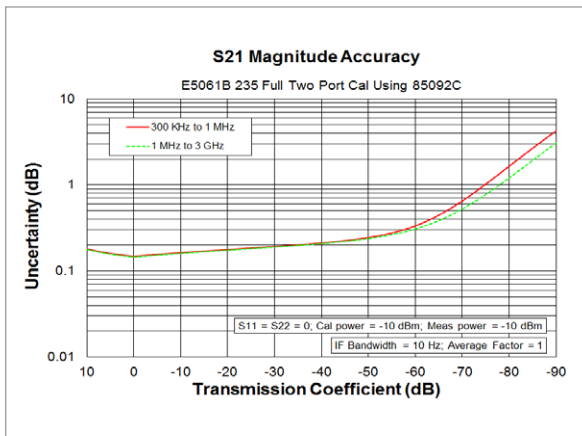

Figure 11. Transmission uncertainty (specification)

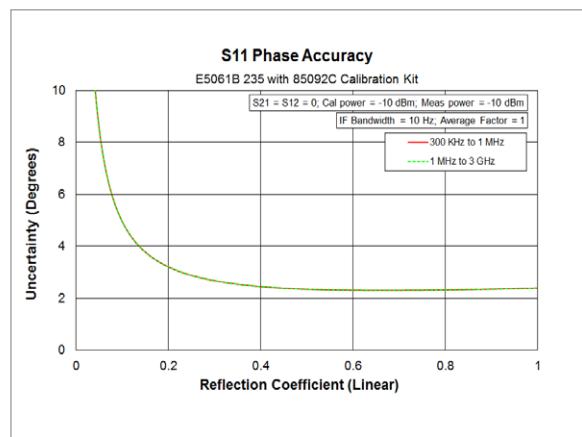
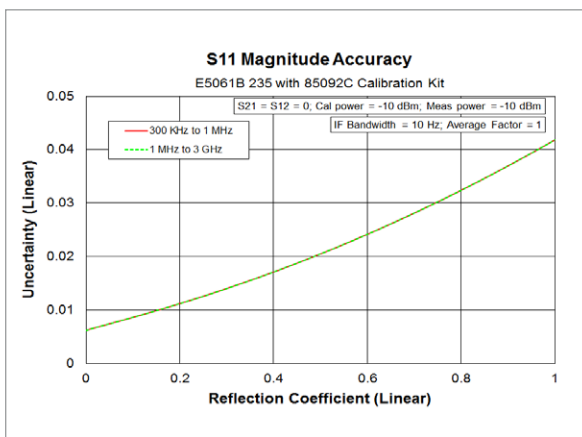

Figure 12. Reflection uncertainty (specification)

Table 8. Corrected system performance with Type-N 75 Ω connectors, 85036B calibration kit, full 2-port calibration

Network analyzer: E5061B-117/137/217/237, calibration kit: 85036B (Type-N, 75 Ω), calibration: Full 2 port

IF bandwidth = 10 Hz, No averaging applied to data, environmental temperature = 23 °C ± 5 °C with < 1 °C deviation from calibration temperature, isolation calibration not omitted

Description	Specification (dB)		
	100 kHz to 300 kHz	300 kHz to 1 MHz	1 MHz to 3 GHz
Directivity	49	48	44
Source match	48	41	35
Load match	48	48	44
Reflection tracking	0.004	0.010	0.019
Transmission tracking	0.022	0.028	0.052

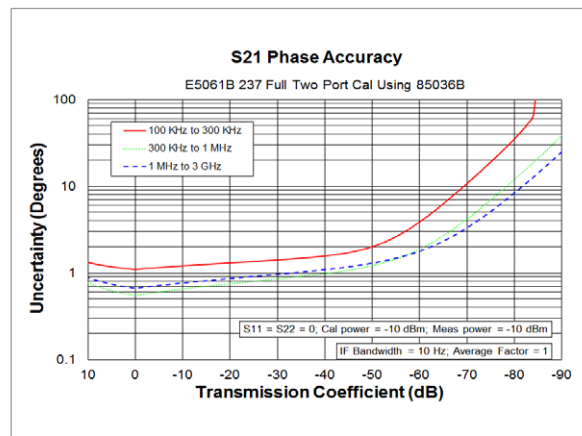
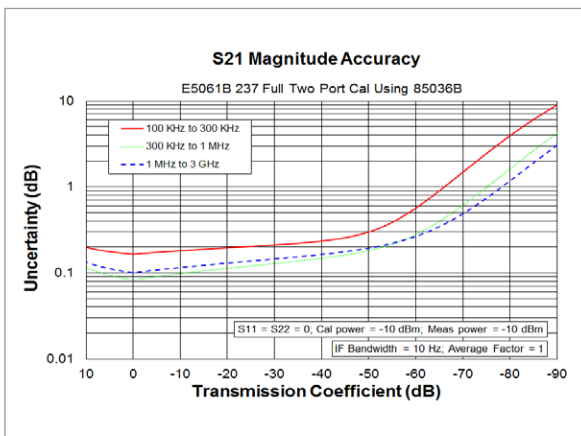

Figure 13. Transmission uncertainty (specification)

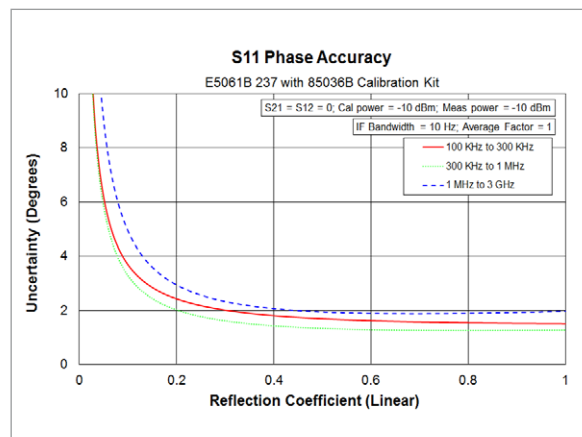
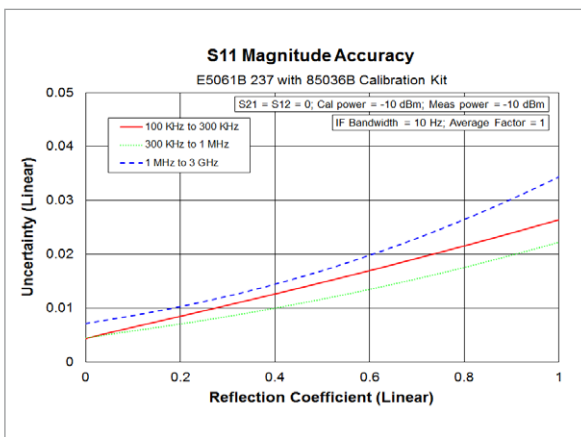

Figure 14. Reflection uncertainty (specification)

Table 9. Corrected system performance with Type-N 75 Ω connectors, 85036B calibration kit, enhanced response calibration

Network analyzer: E5061B-117/137/217/237, calibration kit: 85036B (Type-N, 75 Ω), calibration: enhanced response calibration

IF bandwidth = 10 Hz, No averaging applied to data, environmental temperature = 23 °C ± 5 °C with < 1 °C deviation from calibration temperature, isolation calibration not omitted

Description	Specification (dB)		
	100 kHz to 300 kHz	300 kHz to 1 MHz	1 MHz to 3 GHz
Directivity	49	48	44
Source match	48	41	35
Load match	48	48	44
Reflection tracking	0.004	0.010	0.019
Transmission tracking	0.022	0.028	0.052

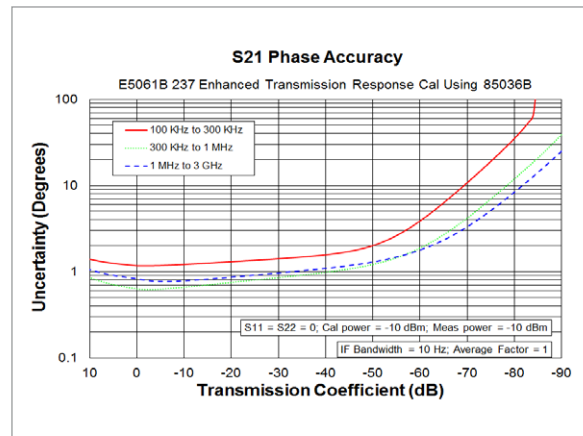
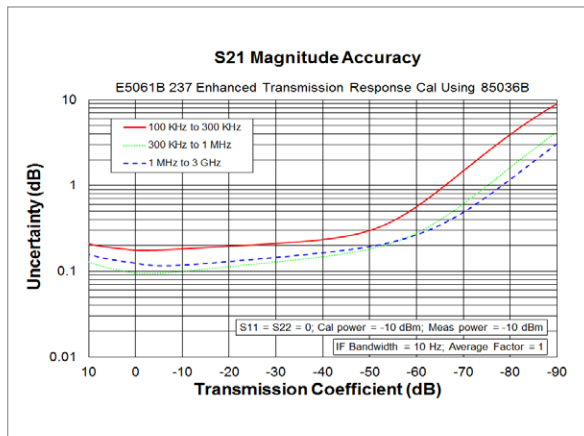

Figure 15. Transmission uncertainty (specification)

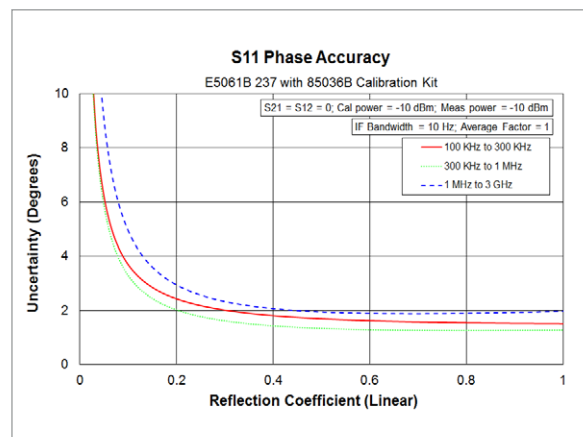
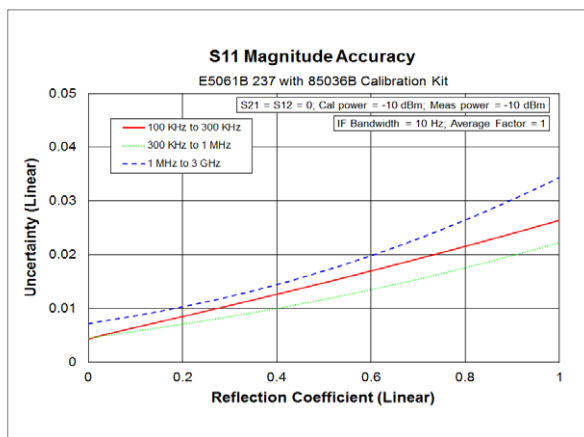

Figure 16. Reflection uncertainty (specification)

## Uncorrected System Performance

Table 10. Uncorrected system performance (correction: off)

Description	Specification	Typical
Directivity (Option 3L3/3L4/3L5)	25 dB	
Directivity (Option 115, 135, 215, 235, 117, 137, 217, 237)	20 dB (at 100 kHz to 300 kHz) 25 dB (at 300 kHz to 3 GHz)	
Source match (Option 3L3/3L4/3L5)	25 dB	
Source match (Option 115, 135, 215, 235, 117, 137, 217, 237)	20 dB (at 100 kHz to 300 kHz) 25 dB (at 300 kHz to 3 GHz)	
Load match (3L3/3L4/3L5)	15 dB (at 5 Hz to 2 GHz) 12 dB (at 2 to 3 GHz)	
Load match (Option 3L3/3L4/3L5, Source AC couple mode)		10 dB (at 100 kHz to 300 kHz) 15 dB (at 300 kHz to 2 GHz) 12 dB (at 2 to 3 GHz)
Load match (Option 115, 135, 215, 235, 117, 137, 217, 237)	10 dB (at 100 k to 300 kHz) 15 dB (at 300 k to 3 GHz)	
Transmission tracking (3L3/3L4/3L5)	± 1.0 dB (at 100 Hz to 3 GHz)	± 1.0 dB (at 5 to 100 Hz)
Transmission tracking (Option 115, 135, 215, 235, 117, 137, 217, 237)	± 1.5 dB (at 100 k to 300 kHz) ± 1.0 dB (at 300 k to 3 GHz)	
Reflection tracking (3L3/3L4/3L5)	± 1.0 dB (at 100 Hz to 3 GHz)	± 1.0 dB (at 5 to 100 Hz)
Reflection tracking (Option 115, 135, 215, 235, 117, 137, 217, 237)	± 1.5 dB (at 100 k to 300 kHz) ± 1.0 dB (at 300 k to 3 GHz)	

## Test Port Output (Source)

Table 11. Test port output frequency

Description	Specification	Typical
Range (Option 3L3)	5 Hz to 500 MHz	
Range (Option 3L4)	5 Hz to 1.5 GHz	
Range (Option 3L5)	5 Hz to 3 GHz	
Range (Option 115, 135, 215, 235, 137, 237)	100 kHz to 3 GHz	
Range (Option 135, 235, 137, 237)	100 kHz to 1.5 GHz	
Resolution	1 mHz	
Source stability		± 7 ppm (5 to 40 °C)
CW accuracy	± 7 ppm ± 1 mHz	
High stability option (Option 1E5)		
CW accuracy	± 1 ppm ± 1 mHz	
Stability		± 0.05 ppm (5 to 40 °C) ± 0.5 ppm per year

Table 12. Test port output power

Description	Specification	Typical
Level accuracy (Option 3L3/3L4/3L5)	± 0.8 dB (at 0 dBm, 50 MHz absolute) ± 1.0 dB (at 5 Hz to 1.5 GHz, 0 dBm, relative to 50 MHz) ± 1.5 dB (at 1.5 GHz to 3 GHz, 0 dBm, relative to 50 MHz)	
Level accuracy (Option 115, 135, 215, 235)	± 0.8 dB (at 0 dBm, 50 MHz absolute) ± 1.5 dB (at 100 kHz to 300 kHz, 0 dBm, relative to 50 MHz) ± 1.0 dB (at 300 kHz to 3 GHz, 0 dBm, relative to 50 MHz)	
Level accuracy (Option 117, 137, 217, 237)	± 0.8 dB (at 0 dBm, 50 MHz absolute) ± 1.5 dB (at 100 kHz to 300 kHz, 0 dBm, relative to 50 MHz) ± 1.0 dB (at 300 kHz to 2 GHz, 0 dBm, relative to 50 MHz)	± 1.0 dB (at 2 GHz to 3 GHz, 0 dBm, relative to 50 MHz)
Level linearity (Option 3L3/3L4/3L5)	± 0.75 dB (at -10 to 10 dBm, 0 dBm reference)	
Level linearity (Option 115, 135, 215, 235, 117, 137, 217, 237)	± 0.75 dB (at -10 to 5 dBm, 100 kHz to 300 kHz, 0 dBm reference) ± 0.75 dB (at -10 to 10 dBm, 300 kHz to 3 GHz, 0 dBm reference)	
Range (Option 3L3/3L4/3L5)	-45 dBm to 10 dBm	
Range (Option 115, 135, 215, 235, 117, 137, 217, 237)	-45 dBm to 5 dBm (at 100 kHz to 300 kHz) -45 dBm to 10 dBm (at 300 kHz to 3 GHz)	
Sweep range (Option 3L3/3L4/3L5)	-45 dBm to 10 dBm	
Sweep range (Option 115, 135, 215, 235, 117, 137, 217, 237)	-45 dBm to 5 dBm (at 100 kHz to 300 kHz) -45 dBm to 10 dBm (at 300 kHz to 3 GHz)	
Level resolution	0.05 dB	

Table 13. Test port output signal purity

Description	Specification	Typical
Harmonics (2nd or 3rd)		< -20 dBc (at 100 kHz to 300 kHz, 5 dBm)
		< -25 dBc (at 300 kHz to 3 GHz, 5 dBm)
Non-harmonic spurious		< -25 dBc (at 5 dBm)

## Test Port Input

Table 14. Test port input levels

Description	Specification	Typical
Absolute amplitude accuracy		< ± 3 dB (at 0 dBm)
Crosstalk <sup>1,3</sup> (Option 3L3/3L4/3L5)		-85 dB (at 5 Hz to 100 Hz)
		-100 dB (at 100 Hz to 9 kHz)
		-110 dB (at 9 kHz to 100 kHz)
		-115 dB (at 100 kHz to 3 GHz)
Crosstalk <sup>2,4</sup> (Option 115, 135, 215, 235, 117, 137, 217, 237)		-100 dB (at 100 kHz to 300 kHz)
		-110 dB (at 300 kHz to 1 MHz)
		-115 dB (at 1 MHz to 3 GHz)

Table 15. Test port input (noise floor)

Description	Specification	Typical
Noise floor (Option 3L3/3L4/3L5)		
3 kHz bandwidth		-80 dBm (100 kHz to 1 MHz)
		-85 dBm (1 MHz to 3 GHz)
2 Hz bandwidth		-80 dBm (5 Hz to 100 Hz)
10 Hz bandwidth		-90 dBm (100 Hz to 9 kHz)
		-100 dBm (9 kHz to 100 kHz)
		-105 dBm (100 kHz to 1 MHz)
		-110 dBm (1 MHz to 3 GHz)
Noise floor (Option 115, 135, 215, 235, 117, 137, 217, 237)		
3 kHz bandwidth		-70 dBm (100 kHz to 300 kHz)
		-80 dBm (300 kHz to 1 MHz)
		-85 dBm (1 MHz to 3 GHz)
10 Hz bandwidth		-95 dBm (100 kHz to 300 kHz)
		-105 dBm (300 kHz to 1 MHz)
		-110 dBm (1 MHz to 3 GHz)

1. The specification might not be met at the frequencies 25 MHz and 90 MHz Line and Fan related frequency.
2. Maximum test port input level: +10 dBm
3. Measured with an IF bandwidth of: 2 Hz (at 5 Hz to 100 Hz) and 10 Hz (at 100 Hz to 3 GHz)
4. Measured with an IF bandwidth of: 10 Hz (at 100 kHz to 3 GHz)

Table 16. Test port input (trace noise)

Description	Specification	Typical
Trace noise magnitude (Option 3L3/3L4/3L5) source power level = +10 dBm	5 mdB rms (< 10 kHz)	
	Automatic IF bandwidth	
	5 mdB rms (10 kHz to 3 GHz)	
	3 kHz bandwidth	
Trace noise magnitude (Option 115, 135, 215, 235, 117, 137, 217, 237)	15 mdB rms (100 to 300 kHz)	
	Maximum output power level 3 kHz Bandwidth	8 mdB rms (300 kHz to 1 MHz)
	5 mdB rms (1 MHz to 3 GHz)	
Trace noise phase (Option 3L3/3L4/3L5) source power level = +10 dBm	0.03° rms (< 10 kHz)	
	Automatic IF bandwidth	
	0.03° rms (10 kHz to 3 GHz)	
	3 kHz Bandwidth	
Trace noise phase (Option 115, 135, 215, 235, 117, 137, 217, 237)	0.09° rms (100 to 300 kHz)	
	Maximum output power level 3 kHz Bandwidth	0.05° rms (300 kHz to 1 MHz)
	0.03° rms (1 MHz to 3 GHz)	

Table 17. Test port input (stability)

Description	Specification	SPD
Stability magnitude (Option 3L3/3L4/3L5) 3 MHz to 3 GHz		0.01 dB/°C
Stability magnitude (Option 115, 135, 215, 235, 117, 137, 217, 237)	100 kHz to 300 kHz	0.05 dB/°C
	300 kHz to 3 MHz	0.02 dB/°C
	3 MHz to 3 GHz	0.01 dB/°C
Stability phase (Option 3L3/3L4/3L5) 3 MHz to 3 GHz		0.1°/°C
Stability phase (Option 115, 135, 215, 235, 117, 137, 217, 237)	100 kHz to 300 kHz	0.5°/°C
	300 kHz to 3 MHz	0.2°/°C
	3 MHz to 3 GHz	0.1°/°C

Table 18. Test port input (dynamic accuracy)

Accuracy of the test port input power reading is relative to -10 dBm reference input power level.

Description	Specification	Typical
Dynamic accuracy magnitude (Option 3L3/3L4/3L5) Reference = -10 dBm	± 0.303 dB (at 10 dBm)	
	± 0.087 dB (at -30 dBm)	
	± 2.141 dB (at -100 dBm)	
Dynamic accuracy magnitude (Option 115, 135, 215, 235, 117, 137, 217, 237) Reference = -10 dB	± 0.303 dB (at 10 dBm)	
	± 0.087 dB (at -30 dBm)	
	± 2.141 dB (at -100 dBm) 300 kHz to 3 GHz	
	± 0.383 dB (at 10 dBm)	
	± 0.167 dB (at -30 dBm)	
	± 2.221 dB (at -100 dBm) 100 to 300 kHz	
Dynamic accuracy phase (Option 3L3/3L4/3L5) Reference = -10 dB	± 2.04 ° (at 10 dBm)	
	± 0.58 ° (at -30 dBm)	
	± 16.23 ° (at -100 dBm)	
Dynamic accuracy phase (Option 115, 135, 215, 235, 117, 137, 217, 237) Reference = -10 dB	± 2.04 ° (at 10 dBm)	
	± 0.58 ° (at -30 dBm)	
	± 16.23 ° (at -100 dBm) 300 kHz to 3 GHz	
	± 2.58 ° (at 10 dBm)	
	± 1.11 ° (at -30 dBm)	
	± 16.94 ° (at -100 dBm) 100 to 300 kHz	



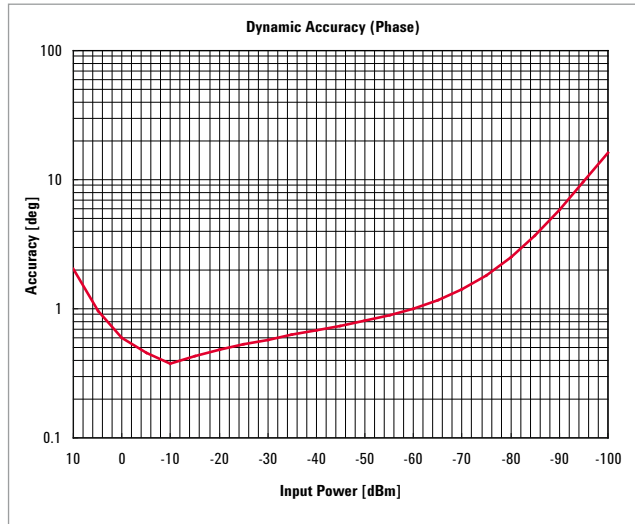
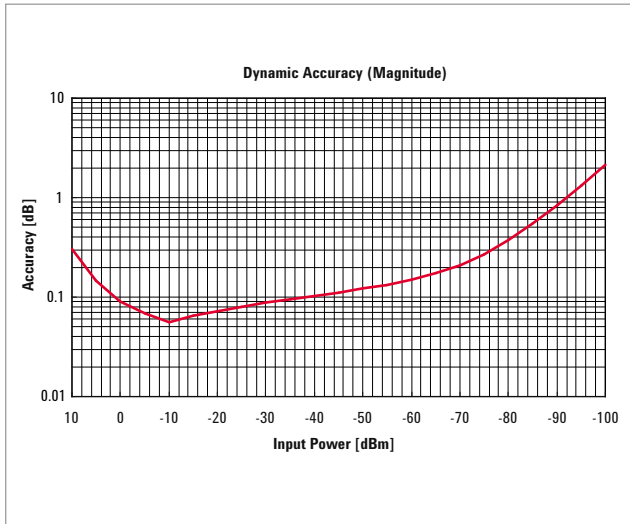

Figure 17. Dynamic Accuracy Option 3L3/3L4/3L5

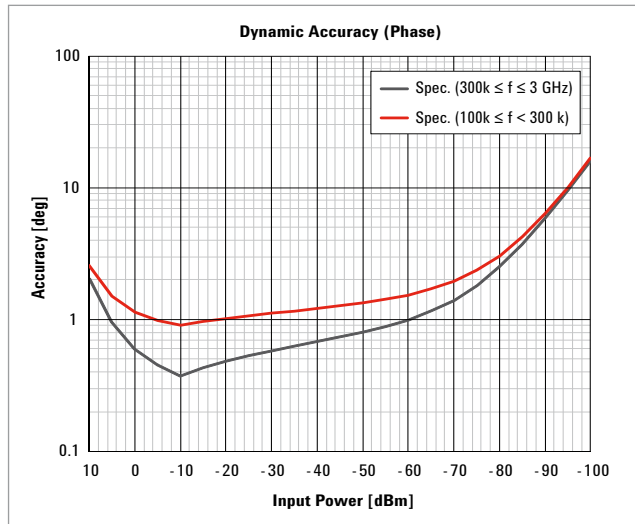
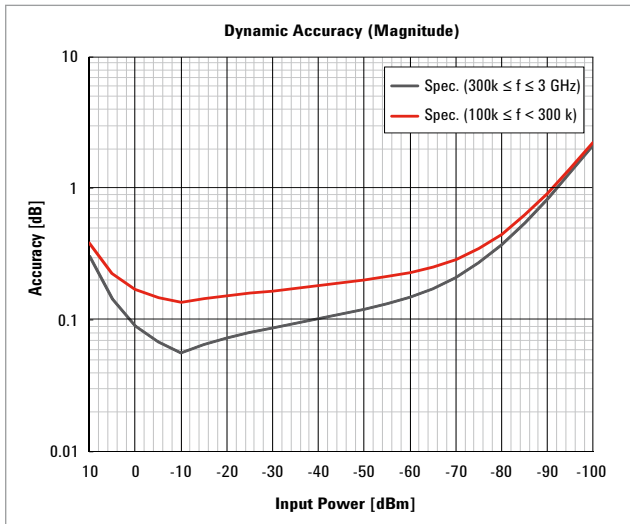

Figure 18. Option 115, 135, 117, 137, 215, 235, 217, 237

Table 19. Test port input (group delay)<sup>1</sup>

Description	Specification	Supplemental information
Aperture (selectable)	(frequency span)/ (number of points -1)	
Maximum aperture	25% of frequency span	
Minimum delay		Limited to measuring no more than 180 ° of phase change within the minimum aperture.
Accuracy		See graph below

The following graph shows group delay accuracy with Type-N full 2-port calibration and a 10 Hz IF bandwidth. Insertion loss is assumed to be < 2 dB.

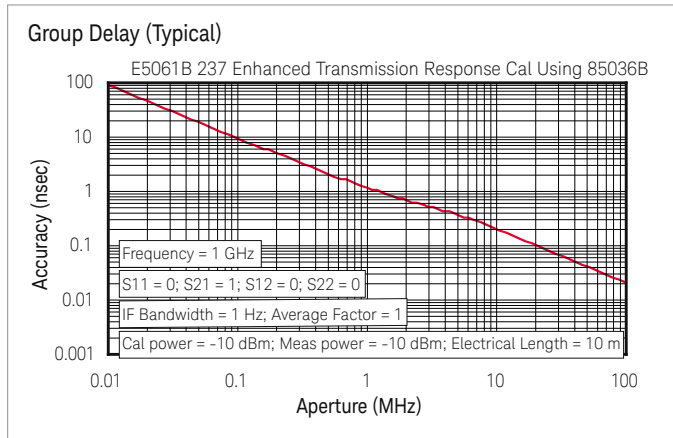

Figure 19. Group delay (typical)

In general, the following formula can be used to determine the accuracy, in seconds, of specific group delay measurement:  $\pm \text{phase accuracy (deg)} / [360 \times \text{aperture (Hz)}]$

1. Group delay is computed by measuring the phase change within a specified step (determined by the frequency span and the number of points per sweep).

## Gain Phase Measurement (Option 3L3/3L4/3L5 only)

### Source characteristics (LF Out)

Table 20. Source characteristics output frequency

Description	Specification	Typical
Range	5 Hz to 30 MHz	
Resolution	1 mHz	
Source stability		± 7 ppm (5 °C to 40 °C)
CW accuracy	± 7 ppm ± 1 mHz	
High stability option (Option 1E5)		
CW accuracy	± 1 ppm ± 1 mHz	
Source stability		± 0.05 ppm (5 °C to 40 °C) ± 0.5 ppm per year

Table 21. Source characteristics output power

Description	Specification	SPD
Level accuracy	± 1 dB (at 0 dBm absolute 200 Hz) ± 2 dB (at 0 dBm, relative to 200 Hz)	
Level	± 1 dB (at -10 dBm to 10 dBm, 0 dBm reference)	± 1 dB (at -45 dBm to -10 dBm, 0 dBm reference)
Range	-45 dBm to 10 dBm	
Sweep range	-45 dBm to 10 dBm	
Level resolution	0.05 dB	

Table 22. Source characteristics output signal purity

Description	Specification	Typical
Harmonics (2nd or 3rd)		< -20 dBc (at 5 dBm)
Non-harmonic spurious		< -25 dBc (at 5 dBm)

Table 23. Source characteristics output impedance

Description	Specification	Typical
Impedance	50 Ω nominal	
Return loss		> 10 dBc

## Test port input characteristics

Table 24. Test port input attenuator

Description	Specification
Input attenuator	0 dB, 20 dB

Table 25. Test port input levels

Description	Specification	Typical
Maximum test port input level	15 dBm (at 20 dB attenuation, 50 Ω)	
	-5 dBm (at 0 dB attenuation, 50 Ω)	
	1.78 V <sub>peak</sub> (at 20 dB attenuation, 1 MΩ)	
	0.18 V <sub>peak</sub> (at 0 dB attenuation, 1 MΩ)	
Absolute amplitude accuracy	< ± 1.5 dB (at -15 dBm, 0 dB attenuation, 50 Ω input impedance)	
	< ± 1.5 dB (at 5 dBm, 20 dB attenuation, 50 Ω input impedance)	
<b>Ratio accuracy</b>		
Magnitude (for the same attenuation setting for both inputs)	< ± 1 dB at (-15 dBm, 0 dB Att.) or (5 dBm, 20 dB Att.) 50 Ω impedance	
	< ± 3 dB at (-15 dBm, 0 dB Att.) or (5 dBm, 20 dB Att.) 1 MΩ impedance using 50 Ω feedthrough	
Phase (for the same attenuation setting for both inputs)	< ± 5 °C at (-15 dBm, 0 dB Att.) or (5 dBm, 20 dB Att.), 50 Ω impedance	
Noise level (referenced to full scale input level at 23 °C ± 5 °C) 0 dB attenuation, 50 Ω, Short termination.	-95 dB (at 5 Hz to 100 Hz, 2 Hz IF bandwidth)	
	-95 dB (at 100 Hz to 9kHz, 10 Hz IF bandwidth)	
	-105 dB (at 9 kHz to 100 kHz, 10 Hz IF bandwidth)	
	-115 dB (at 100 kHz to 10 MHz, 10 Hz IF bandwidth)	
	-110 dB (at 10 MHz to 30 MHz, 10 Hz IF bandwidth)	
Crosstalk <sup>1</sup> (for T/R) For input R: 10 dBm, 20 dB attenuation For input T: 0 dB attenuation, short termination	-110 dB (at 5 Hz to 100 kHz)	
	-120 dB (at 100 kHz to 10 MHz, 10 Hz IF bandwidth)	
	-110 dB (at 10 MHz to 30 MHz, 10 Hz IF bandwidth)	

1. The specification might not be met at the frequencies 25 MHz, line and fan related frequency.

Table 26. Test port input (trace noise)

Description	Specification	Typical
<b>Trace noise</b>		
(at IF automatic bandwidth, < 10 kHz)	5 mdB rms	
(at 3 kHz bandwidth, 10 kHz to 30 MHz at -5 dBm, 0 dB attenuation, 50 Ω)	5 mdB rms	
<b>Trace noise phase</b>		
(at IF automatic bandwidth, < 10 kHz)	0.03 ° rms	
(at 3 kHz bandwidth, 10 kHz to 30 MHz at -5 dBm, 0 dB attenuation, 50 Ω)	0.03 ° rms	

Table 27. Test port input (stability)

Description	Specification	SPD
Stability magnitude		< ± 0.02 dB/°C
Stability phase		< ± 0.2 °/°C

Table 28. Test port input (Dynamic accuracy)<sup>1</sup>

Description	Specification	Typical
Dynamic accuracy magnitude (0 dB attenuation, 50 Ω)	± 0.303 dB at -5 dBm	
	± 0.09 dB at -15 dBm	
	± 0.056 dB at -25 dBm	
	± 0.073 dB at -35 dBm	
	± 0.087 dB at -45 dBm	
	± 0.103 dB at -55 dBm	
	± 0.121 dB at -65 dBm	
	± 0.15 dB at -75 dBm	
	± 0.211 dB at -85 dBm	
	± 0.371 dB at -95 dBm	
	± 0.841 dB at -105 dBm	
	± 2.141 dB at -115 dBm	
Dynamic accuracy phase (0 dB attenuation, 50 Ω)	± 2.04 ° at -5 dBm	± 5 ° (+15 dBm, 20 dB attenuation)
	± 0.6 ° at -15 dBm	
	± 0.37 ° at -25 dBm	
	± 0.48 ° at -35 dBm	
	± 0.58 ° at -45 dBm	
	± 0.68 ° at -55 dBm	
	± 0.81 ° at -65 dBm	
	± 1.00 ° at -75 dBm	
	± 1.41 ° at -85 dBm	
	± 2.5 ° at -95 dBm	
	± 5.83 ° at -105 dBm	
	± 16.23 ° at -115 dBm	

1. Accuracy of the test port input power reading is relative to -25 dBm reference input power level.

Figure 20. Dynamic accuracy

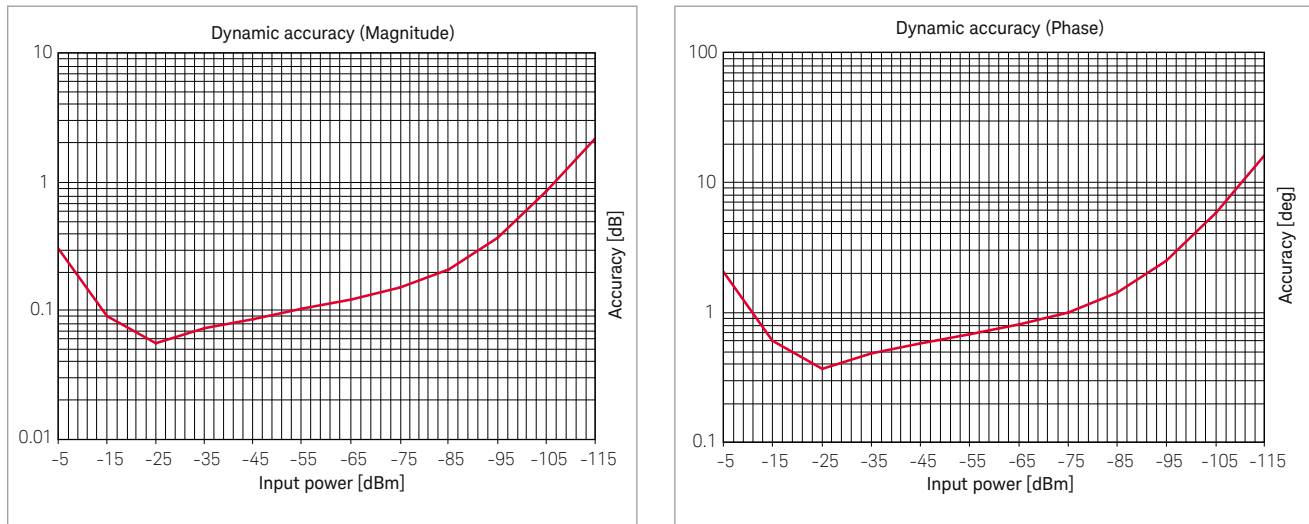

Table 29. Test port input impedance

Description	Specification	Typical
Impedance		50 Ω nominal 1 MΩ / 30 pF
Return loss	> 15 dB at 50 Ω input	

### DC Bias (Option 3L3/3L4/3L5 only)

Table 30. DC bias

Description	Specification
DC voltage bias	
Output Port	Port 1, LF Out
Range	0 to ± 40 V (100 mA max)
Resolution	1 mV ± (0 V to 10 V) 4 mV ± (10 V to 40 V)
Accuracy <sup>1</sup>	± {0.1% + 4 mV} (at Open Port) 23 ± 5 °C
Output Impedance	50 Ω nominal
DC bias monitor	at IFBW = AUTO (= < 100 Hz)
Voltage accuracy	± {0.4% + 50 mV} (at 23 °C ± 5 °C) ± {0.4% + 50 mV} x 4 (at 5 °C to 40 °C) Automatic IF Bandwidth ≤ 100 Hz
Current accuracy	± {1% + 500 μA + ( Vdc[V] /10 kΩ) } (at 23 ± 5 °C) ± {1% + 500 μA + ( Vdc[V] /10 kΩ) } x 2 (at 5 °C to 40 °C) Automatic IF Bandwidth ≤ 100 Hz

1. DC Switching Transient Noise: ± 30 mV (SPD) when port or power switching occur.

## General information

Table 31. System bandwidths

Description	General characteristics
IF bandwidth settings	
Range	1 Hz to 300 kHz
	Nominal settings are: 1, 1.5, 2, 3, 4, 5, 7

Table 32. Number of points

Description	General characteristics
Number of points per traces	2 to 1,601

Table 33. Front panel information

Description	General characteristics	Typical
Connectors		
Type	Type-N, female; 50 or 75 $\Omega$ (Ports 1 and 2)	
Damage Level (Ports 1 and 2)		
Option 3L3/3L4/3L5	+20 dBm, $\pm 7$ VDC (warranted)	
Option 115/135/215/235/ 117/137/217/237	+20 dBm, $\pm 30$ VDC (warranted)	
	BNC, female; 50 $\Omega$ or 1 M $\Omega$ (Ports R and T)	
	BNC, female; 50 $\Omega$ (LF Out)	
Damage Level (Ports R and T)	+26 dBm, $\pm 42$ VDC (at 1M $\Omega$ ) (warranted) +26 dBm, $\pm 7$ VDC (at 50 $\Omega$ ) (warranted)	
Probe power (Option 3L3/3L4/3L5)	15 V $\pm$ 5% (400 mA) -12.6 V $\pm$ 5% (300 mA) (combined load for both probe connections)	
Display		
Size	10.4 inch multi touchscreen LCD	
Resolution	XGA (1024 x 768) <sup>1</sup>	

1. Valid pixels are 99.99% and more. Below 0.01% of fixed points of black, blue, green or red are not regarded as failure.

Table 34. Rear panel information

Description	General characteristics
External trigger input connector	
Type	BNC female
Input level	Low threshold voltage: 0.5 V High threshold voltage: 2.1 V Input level range: 0 to +5 V
Pulse width	≥ 2 μsec
Polarity	Positive or negative
External trigger output connector	
Type	BNC, female
Maximum output current	50 mA
Output level	Low level voltage: 0 V High level voltage: 5 V Adjustable (1 μsec to 1 sec)
Polarity	Positive or negative
External reference signal input connector	
Type	BNC, female
Input frequency	10 MHz ± 10 ppm (Typical)
Input level	0 dBm ± 3 dB (Typical)
Input impedance	50 Ω nominal
Internal reference signal output connector	
Type	BNC, female
Output frequency	10 MHz ± 7 ppm (Typical)
Output level	0 dBm ± 3 dB into 50 Ω
Output impedance	50 Ω nominal
Internal reference signal oven connector	
Type	BNC, female
Output frequency	10 MHz ± 1 ppm
Output level	0 dBm minimum
VGA video output	15-pin mini D-Sub; female; drives VGA compatible monitors
GPIB <sup>1</sup>	24-pin D-Sub (type D-24), female; compatible with IEEE-488
USB port	Universal serial bus jack, type A configuration (4 contacts inline, contact 1 on left); female; provides connection to printer, ECal module, USB/GPIB interface
USB (USBTMC) interface port	Universal serial bus jack, Type B configuration (4 contacts inline); female; provides connection to an external PC; compatible with USBTMC-USB 488 and USB 2.0.
LAN	10/100/1000 BaseT Ethernet, 8-pin configuration; auto selects between the two data rates
24 bit I/O port <sup>2</sup>	36-pin Centronics, female; provides connection to handler system
Line power <sup>3</sup>	
Frequency	47 Hz to 63 Hz
Voltage	90-264 VAC (V <sub>peak</sub> > 120 V)
VA max	300 VA max
Power consumption	
Option 3L5	135 W (SPD)
Others	120 W (SPD)

1. The GPIB interface is optional. To include this interface, order E5061B-721.
2. The 24 bit I/O port interface is optional. To include this interface, order E5061B-731.
3. A third-wire ground is required.



## EMC, safety, environment and compliance







Description	General characteristics
<b>EMC</b>	
 ISM 1-A	European Council Directive 2004/108/EC IEC 61326-1:2012 EN 61326-1:2013 CISPR 11:2009 +A1:2010 EN 55011: 2009 +A1:2010 Group 1, Class A IEC 61000-4-2:2008 EN 61000-4-2:2009 4 kV CD / 8 kV AD IEC 61000-4-3:2006 +A1:2007 +A2:2010 EN 61000-4-3:2006 +A1:2008 +A2:2010 3 V/m, 80-1000 MHz, 1.4 - 2.0 GHz / 1V/m, 2.0 - 2.7 GHz, 80% AM IEC 61000-4-4:2004 +A1:2010 EN 61000-4-4:2004 +A1:2010 1 kV power lines / 0.5 kV signal lines IEC 61000-4-5:2005 EN 61000-4-5:2006 0.5 kV line-line / 1 kV line-ground IEC 61000-4-6:2008 EN 61000-4-6:2009 3 V, 0.15-80 MHz, 80% AM IEC 61000-4-8:2009 EN 61000-4-8:2010 30A/m, 50/60Hz IEC 61000-4-11:2004 EN 61000-4-11:2004 0.5-300 cycle, 0% / 70%
ICES/NMB-001	ICES-001:2006 Group 1, Class A
	AS/NZS CISPR11:2004 Group 1, Class A
	KN11, KN61000-6-1 and KN61000-6-2 Group 1, Class A
<b>Safety</b>	
 ISM 1-A	European Council Directive 2006/95/EC IEC 61010-1:2001/EN 61010-1:2001 Measurement Category I Pollution Degree 2 Indoor Use
 LR95111C	CAN/CSA C22.2 No. 61010-1-04 Measurement Category I Pollution Degree 2 Indoor Use
<b>Environment</b>	
	This product complies with the WEEE Directive (2002/96/EC) marking requirements. The affixed label indicates that you must not discard this electrical/electronic product in domestic household waste. Product Category: With reference to the equipment types in the WEEE Directive Annex I, this product is classed as a "Monitoring and Control instrumentation" product. Do not dispose in domestic household waste. To return unwanted products, contact your local Keysight office

Table 35. Analyzer environment and dimensions

<b>Description</b>	<b>General characteristics</b>
<b>Operating environment</b>	
Temperature	+5 °C to +40 °C
Error-corrected temperature range	23 °C ± 5 °C with < 1 °C deviation from calibration temperature
Humidity	20% to 80% at wet bulb temperature < +29 °C (non-condensing)
Altitude	0 to 2,000 m (0 to 6,561 feet)
Vibration	0.21 G maximum, 5 Hz to 500 Hz
<b>Non-operating storage environment</b>	
Temperature	-10 °C to +60 °C
Humidity	20% to 90% at wet bulb temperature < 40 °C (non-condensing)
Altitude	0 to 4,572 m (0 to 15,000 feet)
Vibration	0.5 G maximum, 5 Hz to 500 Hz
Dimensions	See Figure 21 to 23
Weight	13.1 kg (Option 1xx/2xx) 14.4 kg (Option 3L3/3L4/3L5)
Magnetic susceptibility	<p>Degradation of some product specifications can occur in the presence of ambient power frequency magnetic fields of 30 A/m or greater.</p> <p>The product self-recovers and operates as specified when removed or shielded from the ambient magnetic field.</p> <p>When the analyzer tuned frequency is identical to the immunity test signal frequency, there may be signals of up to -80 dB of full-scale response displayed on the screen.</p>
Magnetic emission	Emission of magnetic field may occur at the left side of the where two cooling fans are installed. Its magnitude can be as much as 160 A/m and 25 A/m at 0 cm and 1 cm apart from the center of the fan, respectively. It is recommended to have enough clearance between the cooling fans and magnetically sensitive device or instruments.

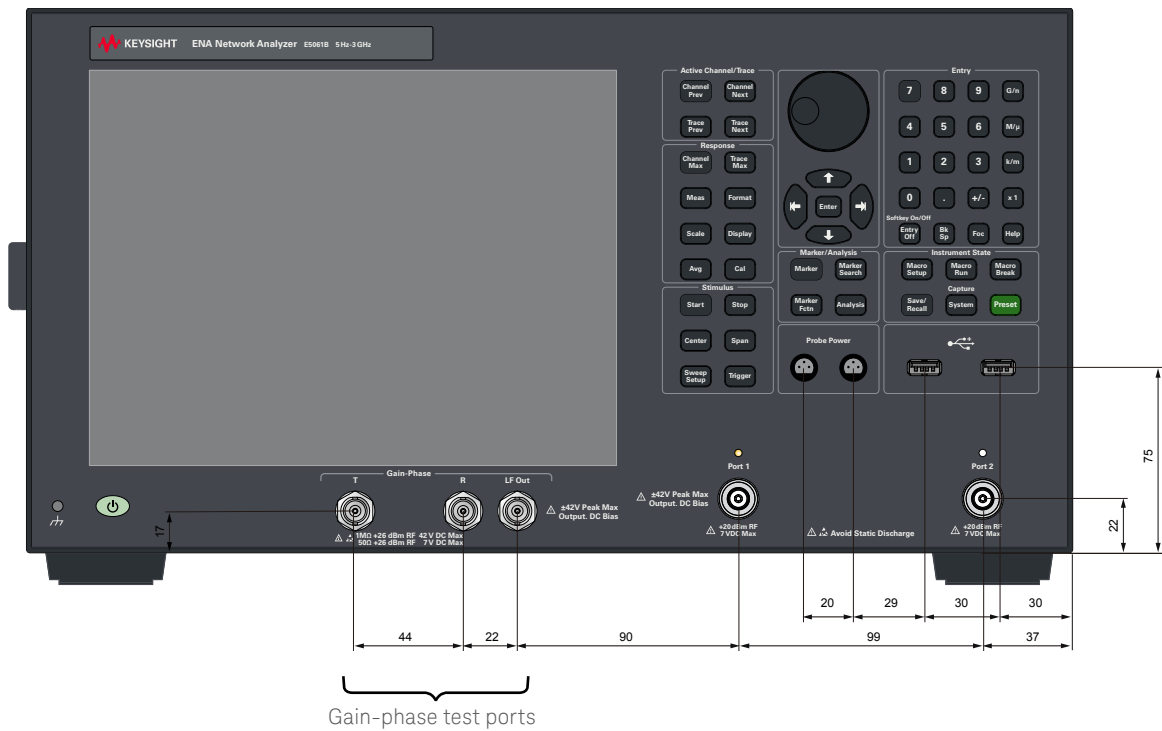

Figure 21. Dimensions (front view, in millimeters) <sup>1</sup>

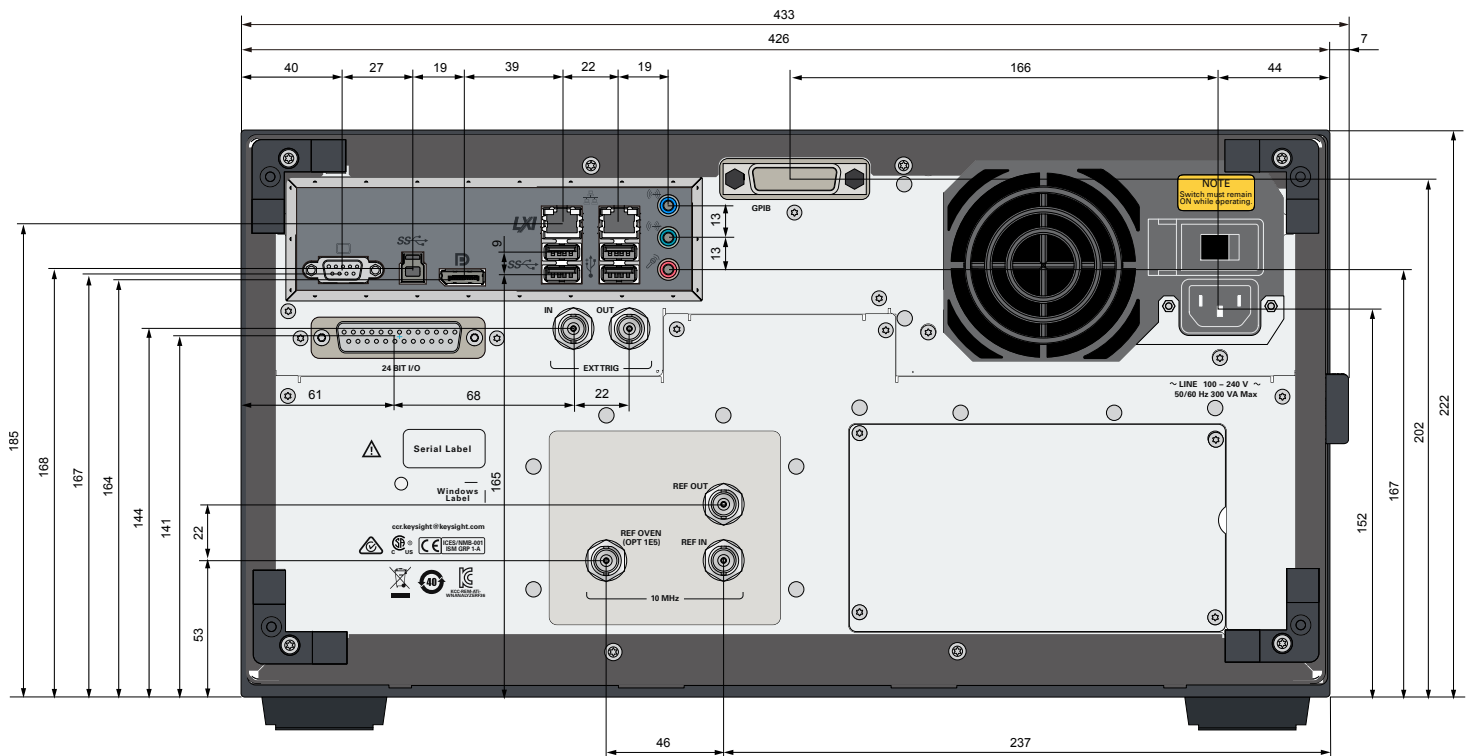

Figure 22. Dimensions (rear view, in millimeters)

1. Options 115, 135, 215, 235, 117, 137, 217, 237 has no gain-phase test port and probe power.

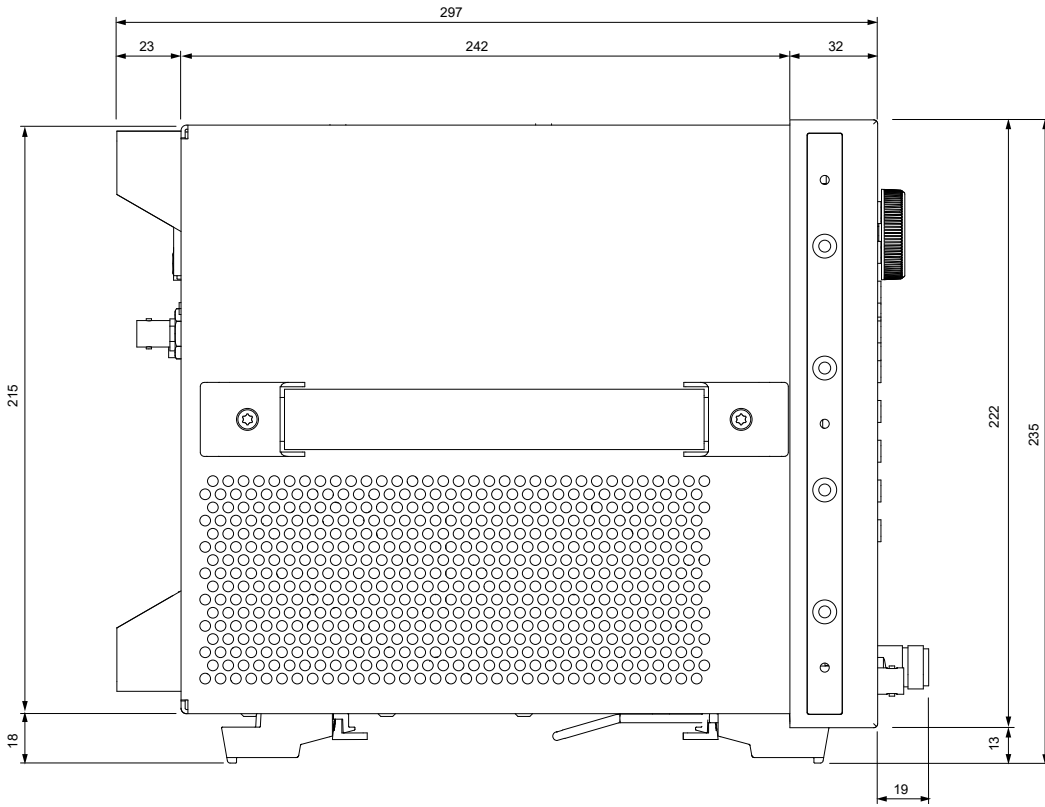

Figure 23. Dimensions (side view, in millimeters)

## Measurement Throughput Summary

Table 36. Typical cycle time for measurement completion <sup>1,2</sup> (ms) (Display update: off)

	Number of points			
	51	201	401	1601
Start 1 GHz, stop 1.2 GHz, 30 kHz IF bandwidth				
Uncorrected	5	15	26	89
2-port cal	14	33	56	181
Start 1 GHz, stop 1.2 GHz, 300 kHz IF bandwidth				
Uncorrected	4	9	15	43
2-port cal	11	21	33	88
Start 1 MHz, stop 3 GHz, 30 kHz IF bandwidth				
Uncorrected	10	23	37	119
2-port cal	24	48	78	241
Start 1 MHz, stop 3 GHz, 300 kHz IF bandwidth				
Uncorrected	9	17	26	73
2-port cal	20	37	54	148

Table 37. Typical cycle time for measurement completion <sup>1</sup> (ms) (Display update: on)

	Number of points			
	51	201	401	1601
Start 1 GHz, stop 1.2 GHz, 30 kHz IF bandwidth				
Uncorrected	45	47	49	103
2-port cal	55	59	69	195
Start 1 GHz, stop 1.2 GHz, 300 kHz IF bandwidth				
Uncorrected	45	47	50	64
2-port cal	55	59	64	103
Start 1 MHz, stop 3 GHz, 30 kHz IF bandwidth				
Uncorrected	45	47	50	133
2-port cal	55	61	90	255
Start 1 MHz, stop 3 GHz, 300 kHz IF bandwidth				
Uncorrected	45	47	50	87
2-port cal	55	59	67	163

1. Typical performance.

2. Measured with the firmware revision A.02.00.

Table 38. Data transfer time <sup>1</sup> (ms)

	Number of points			
	51	201	401	1601
SCPI over GPIB <sup>2</sup>				
REAL 64	5	15	29	109
ASCII	13	50	98	389
SCPI over GPIB/USB (82357B)				
REAL 64	10	22	34	109
ASCII	72	281	567	2246
SCPI over 100 Mbps LAN (SICL-LAN) <sup>2</sup>				
REAL 64	3	3	3	4
ASCII	3	5	7	18
SCPI over 100 Mbps LAN (Socket) <sup>2</sup>				
REAL 64	1	2	2	2
ASCII	14	51	99	386
SCPI over USB <sup>2</sup>				
REAL 64	2	2	2	3
ASCII	3	5	7	25
COM (program executed in the analyzer) <sup>3</sup>				
Variant type	1	1	1	1

1. Data transfer time varies depending on the type of PC and control software.
2. Transferred complex S11 data, using CALC:DATA:FDATA?
3. Measured using E5061B VBA macro running inside the analyzer. Transferred complex S11 data.

## Measurement Capabilities

Number of measurement channels	Up to 4 independent measurement channels. A measurement channel is coupled to stimulus response settings including frequency, IF bandwidth, power level, and number of points.
Number of display windows	Each measurement channel has a display window. Up to 4 display windows (channels) can be displayed.
Number of traces	4 data traces and 4 memory traces per channel
Measurement choices	Option 115,135,117 and 137 - S11, S21, Absolute Option 215, 235 and 237 - S11, S21, S12, S22, Absolute Option 3L3, 3L4, 3L5 - S11, S21, S12, S22, T/R, T, R, Absolute
Measurement parameter conversion	Available to convert S-parameters into reflection impedance, transmission impedance, reflection admittance, transmission admittance, and 1/S.
Data formats	Log magnitude, linear magnitude, phase, expanded phase, positive phase, group delay, SWR, real, imaginary, Smith chart, polar.
Data markers	10 independent markers per trace. Reference marker available for delta marker operation. Smith chart format includes 5 marker formats: linear magnitude/phase, log magnitude/phase, real/imaginary, R + jX, and G + jB. Polar chart format includes 3 marker formats: linear magnitude/phase, log magnitude/phase, and real/imaginary.
<b>Marker functions</b>	
Marker search	Max value, min value, multi-peak, multi-target, peak, peak left, peak right, target, target left, target right, and width parameters with user-defined bandwidth values.
Marker-to functions	Set start, stop, center to active marker stimulus value; set reference to active marker response value; set electrical delay to group delay at active marker.
Search range	User definable.
Tracking	Performs marker search continuously or on demand.
<b>Fault location functions (Option 010)</b>	
Transformation to distance and time domain	Selectable transformation type from bandpass, lowpass impulse, lowpass step. Selectable window from maximum, normal and minimum.
<b>Impedance measurement analysis (Option 005) <sup>1</sup></b>	
Impedance Measurement	Selectable Impedance Parameter and Equivalent Circuit analysis Capability
<b>Wireless power transfer analysis (Option 006) <sup>2</sup></b>	
Wireless power transfer circuit evaluation	Selectable parameters related to wireless power transfer analysis. 2D/3D simulation capability.

1. Option 005 can be installed with option 3L3/3L4/3L5 only

2. Option 006 can be installed with option 215/235/3L5 only

## Source Control

Measured number of points per sweep	User definable from 2 to 1601
Sweep type	Linear sweep, segment sweep, log sweep, power sweep and DC bias sweep
Segment sweep	Define independent sweep segments. Set number of points, test port power levels, IF bandwidth, delay time, sweep time independently for each segment.
Sweep trigger	Set to continuous, hold, or single, sweep with internal, external, manual, or bus trigger.
Power	Set source power from -45 dBm to 10 dBm. The power slope function compensates source power error.

## Trace Functions

Display data	Display current measurement data, memory data, or current measurement and memory data simultaneously
Trace math	Vector addition, subtraction, multiplication or division of measured complex values and memory data
Title	Add custom title to each channel window. Titles are printed on hardcopies of displayed measurements
Autoscale	Automatically selects scale resolution and reference value to vertically center the trace
Electrical delay	Offset measured phase or group delay by a defined amount of electrical delay, in seconds
Phase offset	Offset measured phase or group delay by a defined amount in degrees
Statistics	Calculates and displays mean, standard deviation and peak-to-peak deviation of the data trace



## Data Accuracy Enhancement

Measurement calibration	Measurement calibration significantly reduces measurement uncertainty due to errors caused by system directivity, source and load match, tracking and crosstalk. Full 2-port calibration removes all the systematic errors for the related test ports to obtain the most accurate measurements.
<b>Calibration types available</b>	
Response	Simultaneous magnitude and phase correction of frequency response errors for either reflection or transmission measurements.
Response and isolation	Compensates for frequency response and crosstalk errors of transmission measurements.
Enhanced response	Compensates for frequency response and source match errors.
One-port calibration	Compensates for directivity, frequency response and source match errors.
Full 2-port calibration (option 215, 235, 217, 237, 3L3, 3L4, 3L5)	Compensates for directivity, source match, reflection tracking, load match, transmission tracking and crosstalk. Crosstalk calibration can be omitted.
Interpolated error correction	With any type of accuracy enhancement applied, interpolated mode recalculates the error coefficients when the test frequencies are changed. The number of points can be increased or decreased and the start/stop frequencies can be changed.
Velocity factor	Enter the velocity factor to calculate the equivalent physical length.
Reference port extension	Redefine the measurement plane from the plane where the calibration was done.

## Storage

Internal hard disk drive	Store and recall instrument states, calibration data, and trace data into internal hard drive. Trace data can be saved in CSV (comma separated value) format. All files are MS-DOS-compatible. Instrument states include all control settings, limit lines, segment sweep tables, and memory trace data.
File sharing	Internal hard disk drive (D:) can be accessed from an external Windows PC through LAN.
Screen hardcopy	Printouts of instrument data are directly produced on a printer through USB interfaces.
<b>System capabilities</b>	
Familiar graphical user interface	The analyzer employs a graphical user interface based on Windows operating system. There are three ways to operate the instrument manually: you can use a hardkey interface, touch screen interface or a mouse interface.
Limit lines	Define the test limit lines that appear on the display for pass/fail testing. Defined limits may be any combination of horizontal/sloping lines and discrete data points.

## Automation

	<b>GPIB/LAN/USB</b>	<b>Internal</b>
SCPI	×	×
COM		×
<b>Methods</b>		
Internal analyzer execution	Applications can be developed in a built-in VBA (Visual Basic for Applications) language. Applications can be executed from within the analyzer via COM (component object model) or using SCPI.	
Controlling via GPIB	The GPIB interface operates to IEEE 488.2 and SCPI protocols. The analyzer can be controlled by a GPIB external controller. The analyzer can control external devices using a USB/GPIB interface.	
<b>LAN</b>		
Protocol	TCP/IP	
Function	Telnet, SICL-LAN	
<b>USB</b>		
Protocol	USB Test and Measurement Class (TMC) interface that communicates over USB, complying with the IEEE 488.1 and IEEE 488.2 standards.	