

- Up to 5kV, 2000A High-Power Test
- Accurate very small current Measurement (resolution 250fA)
- Large 12.1-inch Touch Screen
- Variety of GATE Signal Output
- Enhanced Temperature Characteristic Measurement Option
- On-Wafer High-Power Testing with Wafer-Prober



dataTec

Ihr Ansprechpartner /
Your Partner:

dataTec AG
E-Mail: info@datatec.eu
>>> www.datatec.eu

Outline

A combination of features and usability. IWATSU Curve tracer continue to evolve to meet customer needs. The CS-8000 series are equipped with a high-voltage source of up to 5 kV and a high-current source of 2 kA. It features Pulse output, Gate pattern, and very small current measurement capabilities, and it supports the design evaluation of wideband-gap semiconductors such as SiC and GaN.

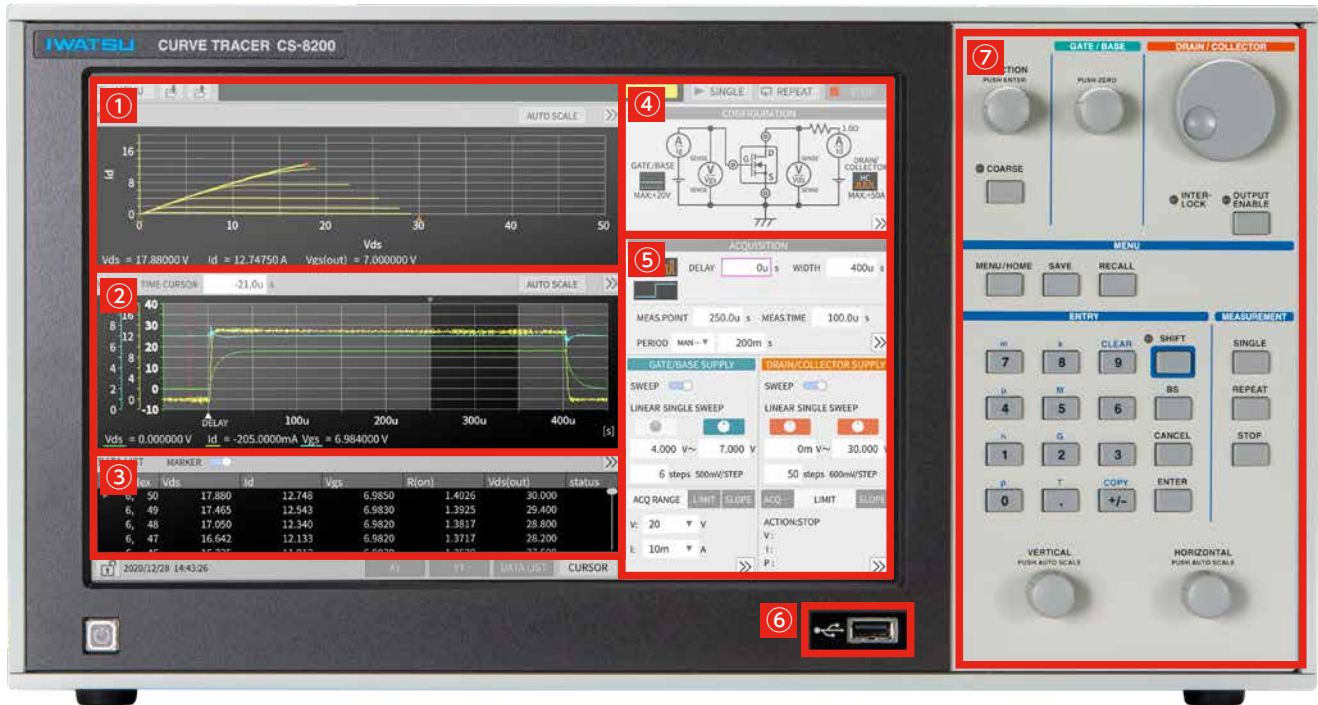

① X-Y Display Window

The voltage/current parameter can be set on the X-axis Y-axis, and a variety of semiconductor characteristic curves such as V_{ds} - I_d characteristics, threshold voltage, and V_{ds} - V_{gs} saturation characteristics can be displayed. Also several parameters can be set on the Y axis. The scale can be selected from Log or Linear.

② Y-T Display Window

The measured applied waveform is displayed on the time axis like an oscilloscope. It is easy to verify if accurate measurements have been operated because the CS-8000 series can show the pulse width, the measurement point and the abnormal waveform such as an oscillation in real time. All applied waveform data and the data on the X-Y display are saved at the same time. So the measurement result can be re-validated.

③ Measurement Data Display Window

This window shows detailed measurement information such as results and conditions, status in text format.

The X-Y, Y-T, and measurement data display areas can be toggled on/off and resized depending on the measurement. Also these three areas are linked together.

④ Configuration Setting Window

In this window, the measurement configuration for the device is set. It supports the selection of voltage/current units, wiring changes, etc. in a graphical display.

⑤ Parameter Setting Window

This area is where you set measurement parameters, measurement limits, and switch between Manual/Auto measurements.

⑥ USB Interface

Waveform images, data and setup conditions can be saved to the USB memory directly.

⑦ Control Panel

DRAIN/COLLECTOR • GATE/BASE • vertical/horizontal axis rotary knob, buttons and rotary knobs are located on the front panel for easy manual measurements. The central numeric keypad allows you to enter a numeric value for the parameter.

Features

Selectable hardware architecture

You can select any voltage and current unit required for your measurement to suit your application.

HV unit

The HV unit is a high voltage unit of 2kV and 5kV. DC or PULSE wave can be selected. Also you can select the constant voltage or constant current drive measurement.

Main unit	CS-8200	CS-8500
Max. Peak Voltage (Max. Peak Current)	2kV (20mA)	5kV (8mA)
Waveform	DC (100mA), PULSE (1A)	
Polarity	+ / -	
Minimum current resolution	250 fA	

MV unit (Common to all main unit)

The MV unit is a 200V medium voltage unit which you can select the constant voltage or constant current drive measurement. Also you can select DC or PULSE, SINE, Rectified or Half-Rectified waveforms.

Max. Peak Voltage (Max. Peak Current)	200V (2A)
Waveform	DC (200mA), PULSE(2A), SINE, Rectified, Half-Rectified
Polarity	+ / - / Bipolar
Minimum current resolution	250 fA

GATE unit (Common to all main unit)

The GATE unit is a 40V unit. You can select the constant voltage or constant current drive measurement. Also DC, PULSE and SINE waveforms can be selected.

Max. Peak Voltage (Max. Peak Current)	40V (1A)
Waveform	DC, PULSE, SINE
Polarity	+ / - / Bipolar
Minimum current resolution	250 fA

HC unit

Because of the HC unit with the high current mode, high current measurements up to 2kA can be performed. The pulse width, measuring period and measuring range can be varied.

HHC unit	CS-205	CS-210	CS-220
Max. Peak Voltage (Max. Peak Current)	500A (50V)	1000A (50V)	2000A (50V)
Waveform	PULSE		
Pulse width	10 μ s ~ 1ms	10 μ s ~ 1ms (500A range or lower) 10 μ s ~ 500 μ s (1000A/2000A)	
Polarity	+ / -		

Minimum current resolution 250fA

The use of triaxial and the optimization of the measurement system has reduced leakage and noise in the equipment, so the stable measurement of very small currents can be performed.

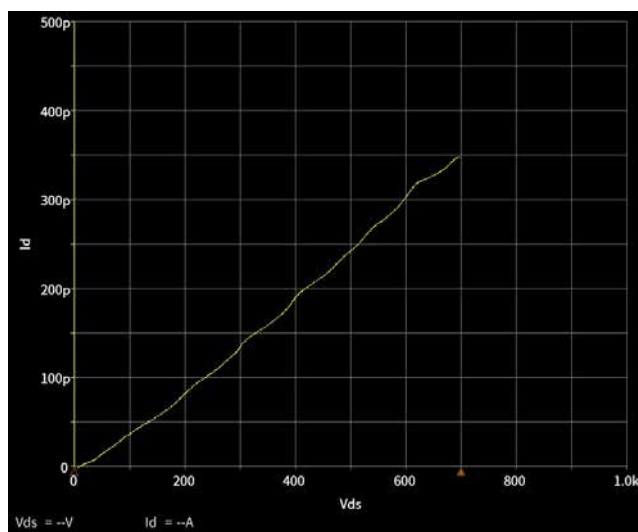

Flexible GATE signal output

The gate signal can be sequenced and applied. Hold-time variable range 0.000[s] ~ 5.000[s]
Pre-signal GATE voltage -40[V] ~ +40[V]

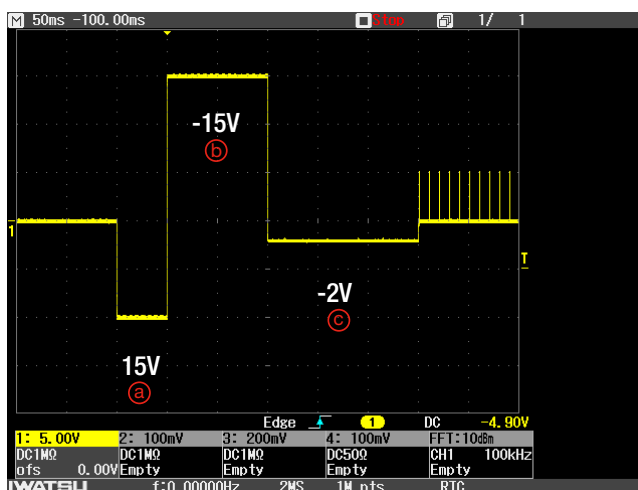

Features

■ Hysteresis measurement

CS-8000 is useful for measuring wideband-gap semiconductors such as SiC and GaN with hysteresis.

“Double sweep function” simultaneously displays up sweep and down sweep, allowing for hysteresis observation.

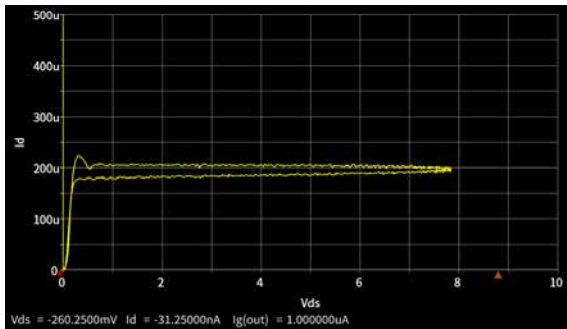

You can adjust the amplitude and time to allow any gate pattern input. Also a preliminary signal enables to be applied to the gate. Devices with hysteresis can be measured under multiple conditions.

■ Configuration for various experiment

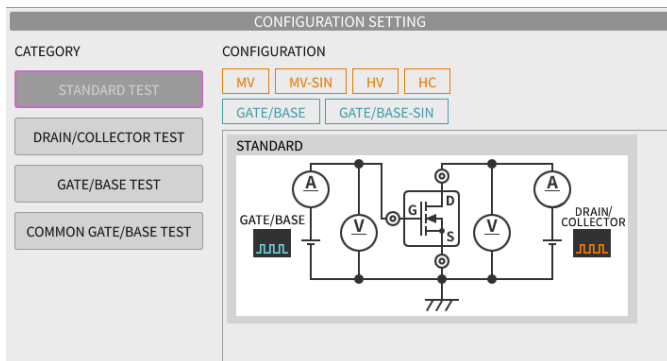

The graphical display of the measurement configuration makes easy to set various settings.

The test fixture CS-322 automatically switches the internal matrix switch to match the configuration settings, eliminating the need for a wiring swap. It is also not necessary to switch the connection between HV and HC units manually. Because the internal relay automatically switches through the configuration settings. These functions prevent incorrect wiring during measurement.

■ UI designed for ease of use

The 12.1 inch Touch Screen, front panel buttons and rotary knob provide intuitive operation. The on-screen keyboard on the screen and the numeric keypad on the front panel allow you to enter settings, limit values, and so on. To enable operation by USB mouse/keyboard.



■ Temperature characteristic measurement

Evaluation of temperature characteristics is required for targets used in high and low temperature environments during actual operation. CS-8000 can be used in combination with hotplate and ThermoStream to measure temperature characteristics. The use of ThermoStream requires test fixture and adapters. Automatic measurement is also available with software.

Hotplate PA3020 / 3040 / 4030 (non-isolation)

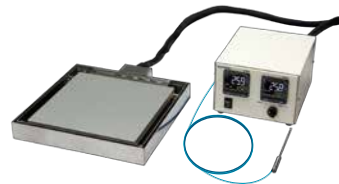

Temp. control by external sensor and RS485
■ MAX. Temperature :
 300°C (PA3020,PA3040) / 400°C (PA4030)
■ CE conformed
■ Accessories : Controller, Temperature sensor, RS-485-USB converter
 - Sizes of hotplate / power consumption -

■ Sizes of hotplate / power consumption

PA3020 : 200×200 (mm) 800W
 PA3040 : 200×400 (mm) 1500W
 PA4030 : 300×200 (mm) 1500W

Test Fixture for ThermoStream



Enables connection with ThermoStream for wide range of temperature measurements.

【Size(mm):Approx.300Wx300Dx200H】
【Power supply : AC adaptor】

Test adaptor for ThermoStream



Adaptors attaching with Test Fixture for ThermoStream
【Withstanding temperature : -50°C to 200°C】

Model	Device package	Remarks
CS-521	TO-220/TO-247	CS-501A compatible
CS-522*	TO-263-3 (D2PAK)	CS-503 compatible
CS-523*	TO-252-3	CS-504 compatible

※Contact us a made-to-order for another packages

Features

Improved on-wafer testing affinity

The output terminals are fitted with noise-resistant triaxial for easy connection to wafer-prober.



External interlock I/F

Output limit function

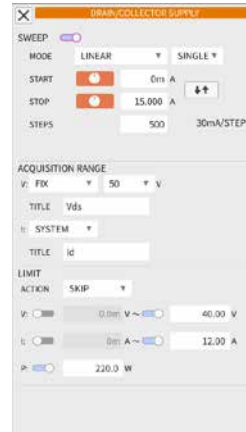

Voltage, current, and power limits can be set to prevent damage to the target. In addition, the hardware overcurrent protection function shuts off current when 1.4 times the current flow of the measuring range.

Safety mechanism

Interlock for safe measurement

An interlock function is linked to the cover of the fixture. During interlock operation, the output is turned off to avoid the electric shock, and the curve tracer keeps safe measurements. Even when you use the prober or temperature chambers, the curve tracer keeps safe measurement in conjunction with external interlock terminal. The LEDs in main unit and test fixture indicate the state of the interlock.



Test fixture



Main unit

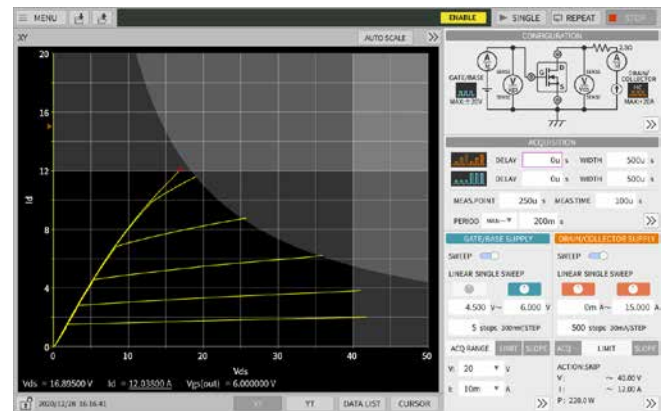

System Configuration

HC units and fixtures can be selected to match the voltage and current of the measuring target.

Configuration Example : 2kV, 2000A

- | | | | |
|--------------|---------------|------------------|--------|
| Main unit | : CS-8200 | Accessory cable | |
| HC unit | : CS-220 | Cable set for HV | CS-021 |
| Test fixture | : CS-322HV/HC | Cable set for HC | CS-022 |



Accessories

CS-520 Patch panel

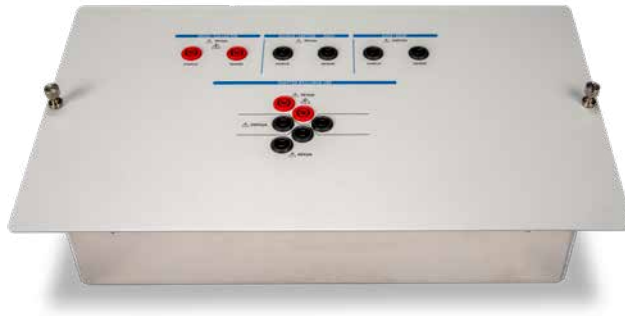

Adaptor installation image

Test adaptors CS-500 series

Heat resistance TO socket

200°C, 350A (500 μs)



Test Fixture for TSSOP 14



SMD type adaptor CS-508

Adaptor for SMD type

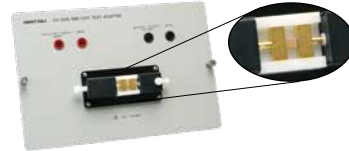

Bottom view
Banana plug



CS-501A

TO



CS-502

AXIAL



CS-503

TO-263-3/ D2PAK



CS-504

TO-252-3



CS-505

TO-263-7



CS-506

TO-252-5



CS-507

SC-70-3/ SOT-323-3



CS-509

SC-59A/ SOT-23-3L



CS-510

SC-62/ SOT-89



Cable

Model	Description	Utility
CS-025	HV cable (L=1.0m)	HV (2kV), HV (5kV) (Force, Sense)
CS-026	Triaxial cable (L=1.0m)	MV, Gate, Emitter (Force, Sense)
CS-027	Control I/F cable (L=1.0m)	Control the related unit
CS-028	Interlock/Sense cable (L=1.0m)	This cable is for Interlock and HC Sense, required for each connection.



CS-025
HV cable



CS-026
Triaxial cable



CS-027
Control I/F cable



CS-028
Interlock/Sense cable

Specification

Main unit model name	CS-8020	CS-8200	CS-8500 (TBD)
HV unit			
Max. peak voltage(Max. current)		2kV (20mA)	5kV (8mA)
Measured voltage range (Full scale)		50V ~ 2kV	50V ~ 5kV
Measured current range	—	20mA ~ 50μA	20mA ~ 50μA
Min. measured current resolution		250fA	250fA
Waveform		DC • PULSE	DC • PULSE
MV unit			
Max. peak voltage(Max. current)		200V (2A)	
Measured voltage range (Full scale)		200mV ~ 200V	
Measured current range		2A ~ 5nA	
Min. measured current resolution		250fA	
Waveform		DC • PULSE • SINE • HALF-WAVE • FULL-WAVE	
GATE unit			
Max. peak voltage(Max. current)		40V (1A)	
Measured voltage range (Full scale)		1V ~ 50V	
Measured current range		1A ~ 5nA	
Min. measured current resolution		250fA	
Waveform		DC • PULSE • SINE (50Hz)	
Standard accessories	Power cord, Control I/F termination, CD (Instruction manual)		

HC unit model name	CS-205	CS-210	CS-220
Max. peak current(Max. Voltage)	500A (50V)	1000A (50V)	2000A (50V)
Waveform	PULSE		
Pulse width	10us ~ 1ms	10μs ~ 1ms (500A range or lower) 10μs ~ 500μs (1000A / 2000A)	
Polarity	+ / -		

※ HC units require separate sense cables.

Test fixture model name	CS-320 (coming soon)	CS-322
Standard accessories	Power cord, Std. Wire set (CS-005), CD (Instruction manual)	
	—	HV/HC cable (2pcs)

※ A separate cable is required to connect the test fixture.

■ **Cable set** To use these cable set when connecting to test fixtures and HC units.

Cable set	Model	Description
CS-020 MV Std cable set (for CS-320)	CS-026	Triaxial cable(L=1.0m) 7pcs
	CS-027	Control I/F cable (L=1.0m) 1 pc
	CS-028	Interlock/Sense cable (L=1.0m) 1 pc
CS-021 HV Std cable set (for CS-322)	CS-025	HV cable (L=1.0m) 2pcs
	CS-026	Triaxial cable(L=1.0m) 7pcs
	CS-027	Control I/F cable (L=1.0m) 1 pc
CS-022 HC Std cable set (for HC unit)	CS-027	Control I/F cable (L=1.0m) 1pc
	CS-028	Interlock/Sense cable (L=1.0m) 1pc

Ordering Information

Items	Description	Model	Remarks
Mainframe	Semiconductor curve tracer	CS-8020	200V, 2A
		CS-8200	2kV, 20mA
		CS-8500	5kV, 8mA
HC unit	HC500	CS-205	500A (50V)
	HC1k	CS-210	1000A (50V)
	HC2k	CS-220	2000A (50V)
Test fixture	Test fixture MV	CS-320	200V / 2A
	Test fixture HV/HC	CS-322	5kV / 2000A
Cable set	Cable set for MV	CS-020	Recommended set for CS-320
	Cable set for HV	CS-021	Recommended set for CS-321/322
	Cable set for HC	CS-022	Recommended set for HC
Cable	HV cable	CS-025	HV(2kV), HV(5kV) (Force, Sense)
	Triaxial cable	CS-026	MV, Gate, Emitter (Force, Sense)
	Control interface cable	CS-027	For unit control
	Interlock/sense cable	CS-028	For Interlock, HC sense
Panel	Patch panel for CS-32x	CS-520	For CS-5xx adaptor
Alligator clip	Alligator clip S*10pcs/set(red)	CS-001	Small Alligator clip (red)
	Alligator clip S*10pcs/set(blk)	CS-002	Small Alligator clip (black)
Test wire /cable	HV wire (red) 5pcs/set	CS-003	High Voltage standard wire set
	Wire (blk) 5pcs/set	CS-004	Standard wire set for voltage
	Std. wire set	CS-005	Standard wire set
	High Current cable	CS-006	High current wire set (20cm x 2pcs)
		CS-007	High current wire set (30cm x 2pcs)
Test adaptor	Test adaptor	CS-500	Blank adaptor
	TO-type test adaptor	CS-501A	TO-220, TO247
	AXIAL adaptor	CS-502	Axial type
	TO-263-3(D2PAK)-type test adaptor	CS-503	TO-263-3 / D2PAK
	TO-252-3-type test adaptor	CS-504	TO252-3
	TO-263-7-type test adaptor	CS-505	TO263-7
	TO-252-5-type test adaptor	CS-506	TO252-5 ※Provide pin assignment at ordering point
	SC-70-3(SOT-323-3)-type test adaptor	CS-507	SC-70-3, SOT-323-3
	SMD-type test adaptor	CS-508	SMD (two contacts) ※Provide pin assignment at ordering point
	SC-59A-type test adaptor	CS-509	SC-59A / SOT-23-3
	SC-62-type test adaptor	CS-510	SC-62 / SOT-89
Others	Wagon	MT-600L	Maximum load :100kg

※The products shown in this catalogue are current models at the date of publication. Design and specification are subject to change without notice for improvement.

※All enterprises including National Instruments and Microsoft, etc. and product names mentioned are trademarks or registered trademarks of the respective owners.

※Some of the products are Regulated Products subject to the Foreign Exchange and Foreign Trade Control Law of Japan. Export should not be allowed without appropriate governmental authorization. Please ask our sales office whether the product concerned is a Regulated Product(s).



Ihr Ansprechpartner /
Your Partner:

dataTec AG
E-Mail: info@datatec.eu
>>> www.datatec.eu

IWATSU <http://www.iti.iwatsu.co.jp>
IWATSU ELECTRIC CO., LTD.

C.S(OK)2103-856-1-00
8511-3124-0