

# R&S®HMP Series Power Supplies User Manual

**dataTec**

Mess- und Prüftechnik. Die Experten.

**Ihr Ansprechpartner /  
Your Partner:**

**dataTec AG**

E-Mail: [info@datatec.eu](mailto:info@datatec.eu)

[datatec.eu](http://datatec.eu)



1178683302  
Version 05

**ROHDE & SCHWARZ**  
Make ideas real



This manual describes the following models and options of the R&S®HMP Series:

- R&S®HMP2020 Two-Channel Power Supply (3629.6718.02)
- R&S®HMP2030 Three-Channel Power Supply (3629.6718.03)
- R&S®HMP4030 Three-Channel Power Supply (3629.6776.03)
- R&S®HMP4040 Four-Channel Power Supply (3629.6776.04)

This manual describes firmware version FW V2.7x and later for the instruments of the R&S®HMP Series.



Mess- und Prüftechnik. Die Experten.

**Ihr Ansprechpartner /  
Your Partner:**

**dataTec AG**

E-Mail: [info@datatec.eu](mailto:info@datatec.eu)

[datatec.eu](http://datatec.eu)

© 2025 Rohde & Schwarz

Muehldorfstr. 15, 81671 Muenchen, Germany

Phone: +49 89 41 29 - 0

Email: [info@rohde-schwarz.com](mailto:info@rohde-schwarz.com)

Internet: [www.rohde-schwarz.com](http://www.rohde-schwarz.com)

Subject to change – data without tolerance limits is not binding.

R&S® is a registered trademark of Rohde & Schwarz GmbH & Co. KG.

All other trademarks are the properties of their respective owners.

1178.6833.02 | Version 05 | R&S®HMP Series

Throughout this document, R&S® is indicated as R&S.

# Contents

<b>1</b>	<b>Safety and regulatory information.....</b>	<b>7</b>
1.1	Safety instructions.....	7
1.2	Labels on the R&S HMP.....	11
1.3	Warning messages in the documentation.....	12
1.4	Korea certification class A.....	12
<b>2</b>	<b>Welcome.....</b>	<b>13</b>
2.1	Key features.....	13
2.2	What's new.....	14
2.3	Documentation overview.....	14
2.3.1	Getting started manual.....	14
2.3.2	User manual.....	14
2.3.3	Printed safety instructions.....	15
2.3.4	Service manual.....	15
2.3.5	Instrument security procedures.....	15
2.3.6	Specifications and product brochures.....	15
2.3.7	Calibration certificate.....	15
2.3.8	Release notes and open-source acknowledgment (OSA).....	16
2.3.9	Application notes, application cards, white papers, etc.....	16
2.3.10	Remote control drivers.....	16
<b>3</b>	<b>Getting started.....</b>	<b>17</b>
3.1	Preparing for use.....	17
3.1.1	Lifting and carrying.....	17
3.1.2	Unpacking and checking.....	17
3.1.3	Choosing the operating site.....	17
3.1.4	Setting up the R&S HMP.....	18
3.1.5	Considerations for test setup.....	20
3.1.6	Preparing for mains voltage.....	21
3.1.7	Connecting to power.....	23
3.1.8	Connecting to LAN.....	24
3.1.9	Connecting a device under test (DUT).....	25
3.1.10	Switching on and off.....	26

<b>3.2 Instrument tour.....</b>	<b>26</b>
3.2.1 Front panel tour.....	27
3.2.2 Rear panel tour.....	30
<b>3.3 Trying out the instrument.....</b>	<b>33</b>
<b>3.4 Instrument control.....</b>	<b>35</b>
3.4.1 Ways to operate the instrument.....	36
3.4.2 Means of manual interaction.....	36
3.4.3 Entering data.....	40
3.4.4 Remote control.....	40
<b>4 Accessing, retrieving and handling data.....</b>	<b>42</b>
<b>5 Instrument functions.....</b>	<b>43</b>
<b>5.1 About the output modes of the R&amp;S HMP.....</b>	<b>43</b>
<b>5.2 Basic functions.....</b>	<b>45</b>
5.2.1 Setting the voltage, current and fuse parameters and activating an output.....	45
5.2.2 Using the tracking function.....	45
5.2.3 Saving and recalling instrument configurations.....	47
<b>5.3 Advanced functions.....</b>	<b>47</b>
5.3.1 Fuse settings.....	47
5.3.2 Overvoltage protection settings.....	49
5.3.3 Arbitrary settings.....	50
<b>5.4 General instrument settings.....</b>	<b>55</b>
5.4.1 Interface.....	56
5.4.2 Key & display functions.....	57
5.4.3 Beeper.....	58
5.4.4 Information.....	59
5.4.5 Reset device.....	59
5.4.6 Firmware update.....	59
<b>6 Application examples.....</b>	<b>61</b>
<b>6.1 Compensating voltage drops on the supply lines.....</b>	<b>61</b>
<b>6.2 Operating in parallel and serial mode.....</b>	<b>62</b>
6.2.1 Serial mode.....	63
6.2.2 Parallel mode.....	64

6.3	Multi-Quadrant operation.....	66
<b>7</b>	<b>Network operation and remote control.....</b>	<b>68</b>
7.1	Remote control interfaces and protocols.....	68
7.1.1	LAN interface.....	69
7.1.2	USB interface.....	71
7.1.3	RS-232 interface.....	72
7.1.4	GPIB interface (IEC/IEEE bus interface).....	72
7.1.5	Status reporting system.....	73
7.2	Remote access settings.....	75
7.3	Connecting the R&S HMP for remote control.....	77
7.4	Adjusting the interface addresses.....	78
7.4.1	LAN interface.....	78
7.4.2	USB interface.....	81
7.4.3	RS-232 interface.....	81
7.4.4	GPIB interface (IEC/IEE bus interface).....	82
7.5	Operating the instrument remotely.....	83
<b>8</b>	<b>Remote control commands.....</b>	<b>84</b>
8.1	Common commands.....	84
8.2	INSTrument:SELEct subsystem.....	87
8.3	SOURCe:VOLTage subsystem.....	89
8.4	SOURce:CURREnt subsystem.....	91
8.5	APPLY subsystem.....	93
8.6	OUTPut subsystem.....	94
8.7	FUSE subsystem.....	95
8.8	VOLTage:PROTection subsystem.....	98
8.9	MEASure subsystem.....	101
8.10	ARBITrary subsystem.....	101
8.11	SYSTem subsystem.....	105
8.12	STATus subsystem.....	107
<b>9</b>	<b>Troubleshooting.....</b>	<b>109</b>
9.1	Displaying status information.....	109
9.2	Problems during firmware update.....	109

<b>9.3</b>	<b>Problems with remote control over LAN.....</b>	<b>109</b>
9.3.1	Cannot establish a LAN connection.....	109
9.3.2	Cannot communicate over LAN.....	110
<b>9.4</b>	<b>Contacting customer support.....</b>	<b>110</b>
<b>10</b>	<b>Transporting.....</b>	<b>111</b>
<b>11</b>	<b>Maintenance, storage and disposal.....</b>	<b>112</b>
11.1	Cleaning.....	112
11.2	Changing fuses.....	112
11.3	Storage.....	112
11.4	Disposal.....	112
	<b>Annex.....</b>	<b>114</b>
<b>A</b>	<b>Hardware interfaces.....</b>	<b>114</b>
A.1	GPIB.....	114
A.2	RS-232.....	115
	<b>Glossary: List of often used terms and abbreviations.....</b>	<b>117</b>
	<b>List of commands.....</b>	<b>119</b>
	<b>Index.....</b>	<b>121</b>

# 1 Safety and regulatory information

The product documentation helps you use the product safely and efficiently. Follow the instructions provided here and in the following sections.

## Intended use

The products of the R&S HMP series provide adjustable DC voltage, current and power for electrical loads. They are designed for industrial use, e.g. production testing, maintenance and engineering labs.

Observe the operating conditions and performance limits stated in the specification document, also called data sheet.

## Target audience

Only connect, set up and use a power supply if you are an electrically skilled person. Such persons have the education and experience needed to recognize risks and avoid hazards of working with electricity.

This document provides information throughout the life cycle of the product, for installers, operators, technicians, maintenance and service personnel.

Follow the safety instructions provided in [Section 1.1, "Safety instructions"](#), on page 7 and the additional information provided during setup or operation procedures.

## Where do I find safety information?

Safety information is part of the product documentation. It warns you of potential dangers and gives instructions on how to prevent personal injury or damage caused by dangerous situations. Safety information is provided as follows:

- In [Section 1.1, "Safety instructions"](#), on page 7. The same information is provided in many languages as printed "Safety Instructions". The printed "Safety Instructions" are delivered with the product.
- Throughout the documentation, safety instructions are provided when you need to take care during setup or operation.

## 1.1 Safety instructions

Products from the Rohde & Schwarz group of companies are manufactured according to the highest technical standards. To use the products safely, follow the instructions provided here and in the product documentation. Keep the product documentation nearby and offer it to other users.

Use the product only for its intended use and within its performance limits. Intended use and limits are described in the product documentation such as the data sheet, manuals and the printed "Safety Instructions". If you are unsure about the appropriate use, contact Rohde & Schwarz customer service.

Only people skilled in electrical work should connect, set up and use the product. Such persons have the education and experience needed to recognize risks and avoid hazards of working with electricity. These users also need sound knowledge of at least one of the languages in which the user interfaces and the product documentation are available.

Reconfigure or adjust the product only as described in the product documentation or the data sheet. Any other modifications can affect safety and are not permitted.

Never open the casing of the product. Only service personnel authorized by Rohde & Schwarz are allowed to repair the product. If any part of the product is damaged or broken, stop using the product. Contact Rohde & Schwarz customer support at <https://www.rohde-schwarz.com/support>.

### **Lifting and carrying the product**

Look up the maximum weight in the data sheet. A single person can only carry a maximum of 18 kg safely depending on age, gender and physical condition. If your product is heavier than 18 kg, do not move or carry it by yourself.

To move the product safely, you can use lifting or transporting equipment such as lift trucks and forklifts. Follow the instructions provided by the equipment manufacturer.

### **Choosing the operating site**

Only use the product indoors. The product casing is not waterproof. Water that enters can electrically connect the casing to live parts, which can lead to electric shock, serious personal injury or death if you touch the casing.

Unless otherwise specified, you can operate the product up to an altitude of 2000 m above sea level. The product is suitable for pollution degree 2 environments where nonconductive contamination can occur. For more information on environmental conditions such as ambient temperature and humidity, see the data sheet.

### **Setting up the product**

Always place the product on a stable, flat and level surface with the bottom of the product facing down. If the product is designed for different positions, secure the product so that it cannot fall over.

If the product has foldable feet, always fold the feet completely in or out to ensure stability. The feet can collapse if they are not folded out completely or if the product is moved without lifting it. The foldable feet are designed to carry the weight of the product, but not an extra load.

If stacking is possible, keep in mind that a stack of products can fall over and cause injury.

If you mount products in a rack, ensure that the rack has sufficient load capacity and stability. Observe the specifications of the rack manufacturer. Always install the products from the bottom shelf to the top shelf so that the rack stands securely. Secure the product so that it cannot fall off the rack.

### Connecting to power

The product is an overvoltage category II product. Connect the product to a fixed installation used to supply energy-consuming equipment such as household appliances and similar loads. Keep in mind that electrically powered products have risks, such as electric shock, fire, personal injury or even death. Replace parts that are relevant to safety only by original parts, e.g. power cables or fuses.

Take the following measures for your safety:

- Before switching on the product, ensure that the voltage and frequency indicated on the product match the available power source. If the power adapter does not adjust automatically, set the correct value and check the rating of the fuse.
- If a product has an exchangeable fuse, its type and characteristics are indicated next to the fuse holder. Before changing the fuse, switch off the product and disconnect it from the power source. How to change the fuse is described in the product documentation.
- Only use the power cable delivered with the product. It complies with country-specific safety requirements. Only insert the plug into an outlet with protective conductor terminal.
- Only use intact cables and route them carefully so that they cannot be damaged. Check the power cables regularly to ensure that they are undamaged. Also ensure that nobody can trip over loose cables.
- Only connect the product to a power source with the safety fuse specified in the data sheet.
- Ensure that you can disconnect the product from the power source at any time. Pull the power plug to disconnect the product. The power plug must be easily accessible. If the product is integrated into a system that does not meet these requirements, provide an easily accessible circuit breaker at the system level.

### Working with hazardous voltages

Voltages higher than 30 V RMS, or 42 V peak, or 60 V DC are regarded as hazardous contact voltages. Direct contact with them can cause serious injuries.

When working with hazardous contact voltages, use protective measures to preclude direct contact with the measurement setup:

- Before each measurement, inspect all components for damage and replace them if necessary.
- Do not touch exposed connections and components when power is applied.
- Casing, chassis and all measuring terminals are connected to a grounding connection. Never disconnect a grounding connection on the product.
- Switch off the power before connecting or disconnecting the terminal block to the rear panel connector. Tighten all wires connected to the terminal block.
- Only use the wires and terminal blocks delivered with the product.
- Only use insulated wires, not stripped wires, for the terminal connections.
- Turn the mains switch off when the product is not in use.

- When operating measuring accessories, only use the cables delivered with the accessory. If you have to use cables from other manufacturers, make sure that they are of the required overvoltage category.

Do not operate the product in series or parallel unless that setup is supported. If accessories are provided for a product, only use them for that product. See the data sheet.

In series or parallel setups, protect yourself against electric shock before connecting access ports such as the Ethernet port or the USB port using one of the following measures:

- Ensure that all products are grounded by connecting them to the AC power.
- Disconnect all power connections to the product, including outputs.

### Measurement categories

IEC 61010-2-030 defines measurement categories that rate instruments on their ability to resist short transient overvoltages that occur in addition to the working voltage. Use the measurement setup only in electrical environments for which they are rated.

- 0 - Instruments without rated measurement category  
For measurements performed on circuits not directly connected to mains, for example, electronics, circuits powered by batteries, and specially protected secondary circuits. This measurement category is also known as CAT I.
- CAT II:  
For measurements performed on circuits directly connected to the low-voltage installation by a standard socket outlet, for example, household appliances and portable tools.
- CAT III:  
For measurements performed in the building installation, such as junction boxes, circuit breakers, distribution boards, and equipment with permanent connection to the fixed installation.
- CAT IV:  
For measurements performed at the source of the low-voltage installation, such as electricity meters and primary overcurrent protection devices.

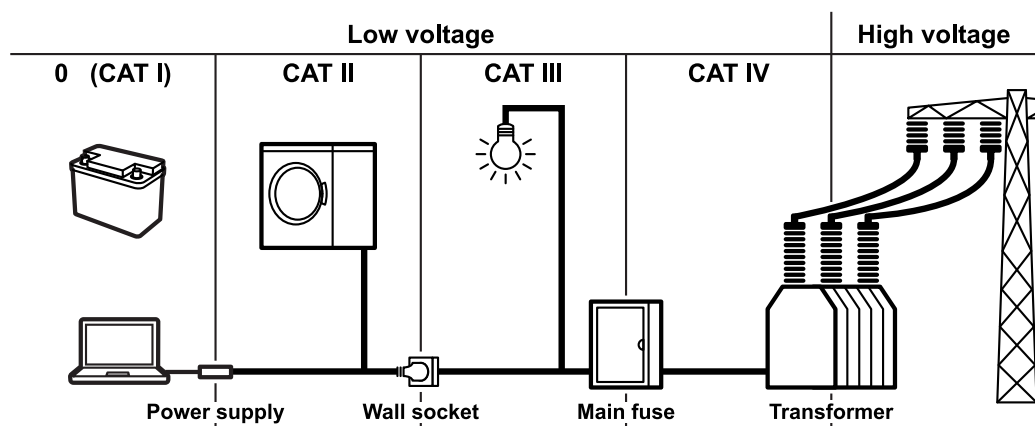





### Cleaning the product

Use a dry, lint-free cloth to clean the product. When cleaning, keep in mind that the casing is not waterproof. Do not use liquid cleaning agents.

### Meaning of safety labels

Safety labels on the product warn against potential hazards.





	<p>Potential hazard</p> <p>Read the product documentation to avoid personal injury or product damage.</p>
	<p>Electrical hazard</p> <p>Indicates live parts. Risk of electric shock, fire, personal injury or even death.</p>
	<p>Hot surface</p> <p>Do not touch. Risk of skin burns. Risk of fire.</p>
	<p>Protective conductor terminal</p> <p>Connect this terminal to a grounded external conductor or to protective ground. This connection protects you against electric shock if an electric problem occurs.</p>



## 1.2 Labels on the R&S HMP

Labels on the casing inform about:

- Personal safety, see "[Meaning of safety labels](#)" on page 11.
- Product and environment safety, see [Table 1-1](#).
- Identification of the product, see the serial number on the [rear panel](#).

**Table 1-1: Labels regarding the R&S HMP and environment safety**

	<p>Labeling in line with EN 50419 for disposal of electrical and electronic equipment after the product has come to the end of its service life. For more information, see "<a href="#">Disposing of electrical and electronic equipment</a>" on page 112.</p>
	<p>Take care when handling electrostatic sensitive devices.</p>
	<p>Grounding terminal (earth ground contact)</p>
	<p>Chassis grounding terminal</p>
	<p>ON (supply voltage)</p>

	OFF (supply voltage)
	Read the manual for information.

### 1.3 Warning messages in the documentation

A warning message points out a risk or danger that you need to be aware of. The signal word indicates the severity of the safety hazard and how likely it will occur if you do not follow the safety precautions.

#### **WARNING**

Potentially hazardous situation. Could result in death or serious injury if not avoided.

#### **CAUTION**

Potentially hazardous situation. Could result in minor or moderate injury if not avoided.

#### **NOTICE**

Potential risks of damage. Could result in damage to the supported product or to other property.

### 1.4 Korea certification class A



이 기기는 업무용(A급) 전자파 적합기기로서 판매자 또는 사용자는 이 점을 주의하시기 바라며, 가정외의 지역에서 사용하는 것을 목적으로 합니다.

## 2 Welcome

The programmable 2-, 3- or 4-channel high-performance power supplies are based on a classical transformer concept with high efficiency electronic pre-regulators and secondary linear regulators. This concept allows the instrument to achieve the high output power within a minimum space, high efficiency and lowest residual ripple.

Depending on the instrument type, up to 4 galvanically isolated and hence combinable channels are available.

The R&S HMP2030 includes three identical channels with a continuous voltage range of 0 V to 32 V. Up to 16 V, the channels can be charged with 5 A and, with the intelligent power management, with as much as 2.5 A at 32 V. Like the R&S HMP2030, the R&S HMP2020 provides an output power of 188 W. The R&S HMP4030 includes three identical channels with a continuous voltage range of 0 V to 32 V. Up to 16 V the channels can be charged with 10 A and at 32 V with as much as 5 A. Like the R&S HMP4030, the R&S HMP4040 provides an output power of 384 W (160 W per channel). Four identical 32 V channels are available.

The high setting and readback resolution of up to 1 mV/0.1 mA (R&S HMP4030/4040 1 mV/0.2 mA) is suitable for applications with extremely high requirements.

An arbitrary function allows you to define freely programmable waveforms for voltage and current, on a timeframe down to 10 ms. You can set an arbitrary waveform with the control panel or transfer an externally created waveform to the R&S HMP.

The R&S HMP series features galvanically isolated, floating overload and short-circuit proof outputs. The outputs can be connected in series or in parallel, thus making high currents and voltages available.

Individual electronic fuses can be logically linked according to user specifications. The fuse linking feature turns off all interlinked channels in case an error occurs.

### 2.1 Key features

The R&S HMP series power supplies set standards in performance and usability. Outstanding key features are:

- High output power within a minimum space, high efficiency and low-residual ripple.
- High programming and readback resolution for applications with the highest demands.
- Realtime voltage, current and power values.
- EasyArb function for programming voltage and current processes directly on the instrument.
- Individual electronic fuses freely combinable for all channels, with a fuse delay from 10 ms to 250 ms.
- Adjustable overvoltage protection (OVP) independently for each channel.
- Advanced parallel and serial operation via V/I tracking.

- Remote control via dual Ethernet/USB interface, USB/RS-232 dual interface or IEEE-488 (GPIB) using SCPI-based commands.

For a detailed specification, refer to the specifications document.

## 2.2 What's new

This manual describes firmware version FW V2.7x and later for the instruments of the R&S®HMP Series.

Compared to the previous version, it provides the following changes:

- Safety and regulatory information updated, see [Section 1, "Safety and regulatory information"](#), on page 7.
- Application examples updated, see [Section 6, "Application examples"](#), on page 61.
- Network operation and remote control updated, see [Section 7, "Network operation and remote control"](#), on page 68.
- Troubleshooting, see [Section 9, "Troubleshooting"](#), on page 109.
- Transporting, see [Section 10, "Transporting"](#), on page 111.
- Maintenance, storage and disposal, see [Section 11, "Maintenance, storage and disposal"](#), on page 112.

## 2.3 Documentation overview

This section provides an overview of the R&S HMP user documentation. Unless specified otherwise, you find the documents at:

[www.rohde-schwarz.com/manual/hmp](http://www.rohde-schwarz.com/manual/hmp).

Further documents are available under [www.rohde-schwarz.com/hmp2000](http://www.rohde-schwarz.com/hmp2000) and [www.rohde-schwarz.com/hmp4000](http://www.rohde-schwarz.com/hmp4000).

### 2.3.1 Getting started manual

Introduces the R&S HMP and describes how to set up and start working with the product. Includes basic operations, and general information, e.g. safety instructions, etc. A printed version is delivered with the instrument.

### 2.3.2 User manual

The user manual contains the description of all instrument modes and functions. It also provides an introduction to remote control, a complete description of the remote control commands with programming examples, and information on maintenance, instrument interfaces and error messages. Includes the contents of the getting started manual.

The contents of the user manual are available as help in the R&S HMP. The help offers quick, context-sensitive access to the complete information for the instrument and its firmware.

The user manual is also available for download or for immediate display on the Internet.

### 2.3.3 Printed safety instructions

Provides safety information in many languages. The printed document is delivered with the product.

### 2.3.4 Service manual

Describes the performance test for checking the rated specifications, module replacement and repair, firmware update, troubleshooting and fault elimination, and contains mechanical drawings and spare part lists.

The service manual is available for registered users on the global Rohde & Schwarz information system (GLORIS):

<https://gloris.rohde-schwarz.com>

### 2.3.5 Instrument security procedures

Deals with security issues when working with the R&S HMP in secure areas. It is available for download on the internet.

### 2.3.6 Specifications and product brochures

The specifications document, also known as the data sheet, contains the technical specifications of the R&S HMP. It also lists the firmware applications and their order numbers, and optional accessories.

The brochure provides an overview of the instrument and deals with the specific characteristics.

See [www.rohde-schwarz.com/brochure-datasheet/hmp](http://www.rohde-schwarz.com/brochure-datasheet/hmp).

### 2.3.7 Calibration certificate

The document is available on <https://gloris.rohde-schwarz.com/calcert>. You need the device ID of your instrument, which you can find on a label on the rear panel.

### 2.3.8 Release notes and open-source acknowledgment (OSA)

The release notes list new features, improvements and known issues of the current software version, and describe the software installation.

The software uses several valuable open source software packages. An open source acknowledgment document provides verbatim license texts of the used open source software.

See [www.rohde-schwarz.com/firmware/hmp](http://www.rohde-schwarz.com/firmware/hmp).

### 2.3.9 Application notes, application cards, white papers, etc.

These documents deal with special applications or background information on particular topics.

See [www.rohde-schwarz.com/application/hmp](http://www.rohde-schwarz.com/application/hmp)

### 2.3.10 Remote control drivers

The instrument drivers enable remote control using the corresponding interfaces. The drivers and installation instructions are available for download on the product page.

See [www.rohde-schwarz.com/driver/hmp](http://www.rohde-schwarz.com/driver/hmp).

## 3 Getting started

This section contains the information you have received as a printed book together with your instrument. The information is provided again to enable you to search throughout the complete description.

### 3.1 Preparing for use

Here, you can find basic information about setting up the product for the first time.

#### 3.1.1 Lifting and carrying

See ["Lifting and carrying the product"](#) on page 8.

For mounting the R&S HMP in a rack, see [Section 3.1.4.2, "Mounting the R&S HMP in a rack"](#), on page 19

#### 3.1.2 Unpacking and checking

1. Unpack the product carefully.
2. Retain the original packing material. Use it when transporting or shipping the product later.
3. Using the delivery notes, check the equipment for completeness.
4. Check the equipment for damage.

If the delivery is incomplete or equipment is damaged, contact Rohde & Schwarz.

#### 3.1.3 Choosing the operating site

Specific operating conditions ensure proper operation and avoid damage to the product and connected devices. For information on environmental conditions such as ambient temperature and humidity, see the specifications document.

For safety information, see ["Choosing the operating site"](#) on page 8.

##### **Electromagnetic compatibility classes**

The electromagnetic compatibility (EMC) class indicates where you can operate the product. The EMC class of the product is given in the specifications document.

- Class B equipment is suitable for use in:
  - Residential environments

- Environments that are directly connected to a low-voltage supply network that supplies residential buildings
- Class A equipment is intended for use in industrial environments. It can cause radio disturbances in residential environments due to possible conducted and radiated disturbances. It is therefore not suitable for class B environments. If class A equipment causes radio disturbances, take appropriate measures to eliminate them.

### 3.1.4 Setting up the R&S HMP

See also:

- ["Setting up the product"](#) on page 8
- ["Intended use"](#) on page 7

#### 3.1.4.1 Placing the R&S HMP on a bench top

##### To place the product on a bench top

1. Place the product on a stable, flat and level surface. Ensure that the surface can support the weight of the product. For information on the weight, see the specifications document.
2. **CAUTION!** Foldable feet can collapse. For safety information, see ["Setting up the product"](#) on page 8.  
Always fold the feet completely in or out. With folded-out feet, do not place anything on top or underneath the product.
3. **WARNING!** A stack of products can fall over and cause injury. Never stack more than three products on top of each other. Instead, mount them in a rack.

Stack as follows:

- If the products have foldable feet, fold them in completely.
- It is best if all products have the same dimensions (width and length). If the products have different dimensions, stack according to size and place the smallest product on top.
- Do not exceed the permissible total load placed on the product at the bottom of the stack:
  - 50 kg when stacking products of identical dimensions (left figure).
  - 25 kg when stacking smaller products on top (middle figure).

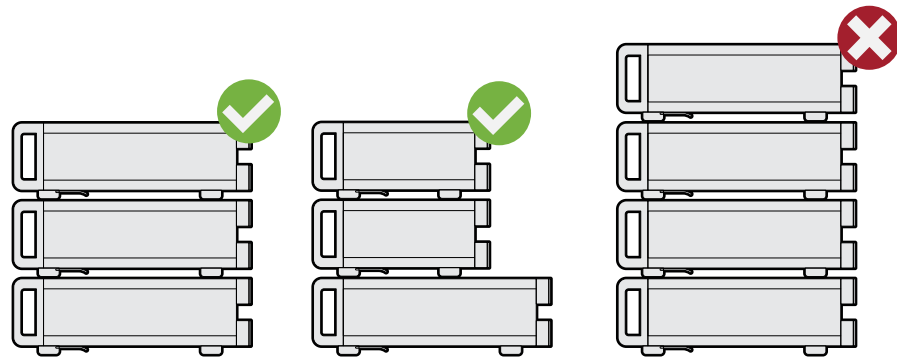

Left = Stacked correctly, same dimensions  
 Middle = Stacked correctly, different dimensions  
 Right = Stacked incorrectly, too many products

#### 4. **NOTICE!** Overheating can damage the product.

Prevent overheating as follows:

- Keep a minimum distance of 10 cm between the fan openings of the product and any object in the vicinity to provide sufficient airflow and ventilation.
- Do not place the product next to heat-generating equipment such as radiators or other products.

#### 3.1.4.2 Mounting the R&S HMP in a rack

##### To prepare the rack

1. Observe the requirements and instructions in "[Setting up the product](#)" on page 8.
2. **NOTICE!** Insufficient airflow can cause overheating and damage the product. Design and implement an efficient ventilation concept for the rack.

##### To mount the R&S HMP in a rack

1. Use an adapter kit that fits the dimensions of the R&S HMP to prepare the instrument for rack mounting.
  - a) Order the rack adapter kit designed for the R&S HMP. For the order number, see the specifications document.
  - b) Mount the adapter kit. Follow the assembly instructions provided with the adapter kit.
2. Lift the R&S HMP to shelf height.
3. Push the R&S HMP onto the shelf until the rack brackets fit closely to the rack.
4. Tighten all screws at the rack brackets with a tightening torque of 1.2 Nm to secure the R&S HMP in the rack.

**To unmount the product from a rack**

1. Loosen the screws at the rack brackets.
2. Bring the lifting equipment to shelf height.
3. Remove the product from the rack.
4. If placing the R&S HMP on a bench top again, unmount the adapter kit from the R&S HMP. Follow the instructions provided with the adapter kit.

### 3.1.5 Considerations for test setup

**Cable selection and electromagnetic interference (EMI)**

Electromagnetic interference (EMI) can affect the measurement results.

To suppress electromagnetic radiation during operation:

- Use high-quality shielded cables, for example:
  - Double-shielded data cables for connecting external devices. The length of data cables must not exceed 3 m.
  - Double-shielded USB cables. The length of passive USB cables must not exceed 1 m.
  - CAT5e LAN cables, e.g. RJ-45 with a length  $\leq 3$  m.
  - Double-shielded IEEE-488 (GPIB) bus cables. We recommend that you use the double-shielded cable "R&S HZ72" from Rohde & Schwarz (GPIB-cable 2 m, order no. 3594.4269.02).
- Cables for output supply:
  - Use insulated cables of the same type
  - Keep the cable length as short as possible
  - Use cables with maximum cross-section to minimize the conductor resistance
- Terminal blocks (included) for connecting to the rear panel connectors.
- Always terminate open cable ends.
- Ensure that connected external devices comply with EMC regulations.
- Check regularly that all cables, including power cables are in perfect condition.

**Input and output levels**

Information on voltage levels is provided in the specifications document. Keep the voltage levels within the specified ranges to avoid damage to the product and connected devices.

**Preventing electrostatic discharge (ESD)**

Electrostatic discharge is most likely to occur when you connect the front and rear connectors simultaneously.

Electrostatic discharge is most likely to occur:

- When connecting the output connectors at the front and rear panels simultaneously.
- When connecting or disconnect a DUT.

1. **NOTICE!** Electrostatic discharge can damage the electronic components of the product and the device under test (DUT).

Ground yourself to prevent electrostatic discharge damage:

- a) Use a wrist strap and cord to connect yourself to ground.
- b) Use a conductive floor mat and heel strap combination.

2. Leave the output sockets at the front disconnected, when using the rear panel outputs.

### 3.1.6 Preparing for mains voltage

The R&S HMP is designed for 115 V or 230 V mains voltage. The range is specified on the label below the [AC power supply](#) at the [rear panel](#), and in the specifications document.

If the mains voltage exceeds the permissible range, contact the Rohde & Schwarz customer service, see [Section 9.4, "Contacting customer support"](#), on page 110.

Take care to adjust the R&S HMP to the supplied mains voltage. When delivered, the R&S HMP is configured for 230 V mains voltage.

The product is protected by two fuses. The suitable fuse type depends on the supplied mains voltage and the R&S HMP model. [Table 3-1](#) shows the suitable fuse types.

*Table 3-1: Fuse types*

Mains voltage	R&S HMP2020 / R&S HMP2030	R&S HMP4030 / R&S HMP4040
115 V	2 x T6.3H/250V (IEC 60127-2/5-T6.3H/250V, order no. 0020.7630.00)	2 x T10H/250 V (IEC 60127-2/5-T10H/250V, order no. 0606.3136.00)
230 V	2 x T3.15H/250 V (IEC 60127-2/5-T3.15H/250V, order no. 0099.6729.00)	2 x T5H/250 V (IEC 60127-2/5-T5H/250V, order no. 0099.6735.00)

#### 3.1.6.1 Preparing for 115 V

If you want to supply the R&S HMP with 115 V mains voltage, you need to do the following:

- ["To change the fuses"](#) on page 22
- ["To set the supplied mains voltage"](#) on page 23

### To change the fuses

The fuses for 115 V mains voltage are delivered with the R&S HMP.

1. **WARNING!** The fuse is part of the AC power supply. Handling the fuse while the power is on can lead to electric shock.  
Before changing the fuse, disconnect the product from the power source.
2. Insert a flathead screwdriver with a blade width of approximately 2 mm under the small opening tab of the fuse holder.



*Figure 3-1: AC power connector*

- 1 = Power supply connector  
2 = Opening tab of the fuse holder

When unlocking the mechanism, the fuse holder is pushed outwards by compression springs.

3. Pull out the fuse holder.
4. Lever out the fuses.  
Keep the fuses for later use, if intact.
5. **WARNING!** If the fuse protection is insufficient, the R&S HMP can overheat and even cause a fire.  
Check the fuse rating on the caps of both fuses that were delivered with the R&S HMP. Make sure that the fuse types match the characteristics that are indicated next to the fuse holder for 115 V mains voltage.
6. Inspect the compression springs of the fuse holder carefully. With deformed or protruding springs, you cannot insert the fuses properly. Contact Rohde & Schwarz at <http://www.customersupport.rohde-schwarz.com>.
7. Insert the fuses into the groove of the fuse holder.
8. Align the fuse holder with the guide bar facing the socket.
9. Carefully slide the fuse holder against the spring pressure into the slot until both plastic locks latch.

### To set the supplied mains voltage

The [AC voltage](#) switch selector is at the [rear panel](#).

- ▶ To set to 115 V mains voltage, use a tool e.g. a flat screwdriver to slide the voltage selector so that the label indicates *115 V*.

#### 3.1.6.2 Reverting to 230 V

If needed, you can revert to 230 V mains voltage by:

- Inserting the fuses for 230 V mains voltage.
- Selecting 230 V as supplied mains voltage.

### 3.1.7 Connecting to power

For safety information, see:

- ["Connecting to power"](#) on page 9
- ["Working with hazardous voltages"](#) on page 9

#### To ground the chassis

1. Plug a cable with a banana plug into the ground socket  at the [front panel](#), see ["Protective conductor terminal"](#) on page 30.  
See also [Table 1-1](#).
2. Connect the cable to ground.

#### To connect to AC supply

1. If necessary, ground the chassis of the R&S HMP. See ["To ground the chassis"](#) on page 23.
2. **WARNING!** If the fuse protection is insufficient, the R&S HMP can overheat and even cause a fire.  
Ensure that R&S HMP is prepared for the supplied mains voltage. See [Section 3.1.6, "Preparing for mains voltage"](#), on page 21.
3. Plug the AC power cable into the AC power supply connector. Only use the AC power cable delivered with the R&S HMP.
4. Plug the AC power cable into a power outlet with ground contact.  
Do not use a cheater plug or other means to bypass or disconnect the protective ground lead.  
  
The required ratings are listed on the front panel of the R&S HMP, see [Section 3.2.2, "Rear panel tour"](#), on page 30.

### 3.1.8 Connecting to LAN

Option: R&S HO732 dual Ethernet / USB interface

Equipped with the interface, the R&S HMP provides Ethernet (LAN) connectivity. If you have assigned the corresponding rights, you can use this interface for remote control and data transfer from a controller PC. Make sure that you have connected the controller PC in the same network.

Consult your network administrator before performing the following tasks to avoid a network failure:

- Connecting the instrument to the network
- Configuring the network
- Changing IP addresses

For remote control over other interfaces, refer to the description in [Section 7, "Network operation and remote control"](#), on page 68.

#### To operate securely

1. **NOTICE!** The R&S HMP is designed to operate at local workplaces or in secured networks (LAN).  
When connected to the LAN, the R&S HMP can potentially be accessed from the internet, which constitutes a security risk. For example, attackers can misuse or damage your device.  
Use secured connections for internet or remote access, if applicable.
2. Ensure that the network settings comply with the security policies of your company. Contact your local system administrator or IT department before connecting your product to your company LAN.
3. Always install the latest firmware.

#### To connect to the LAN

Option: R&S HO732 dual Ethernet / USB interface

The LAN connector is at the [rear panel](#).

1. **WARNING!** Risk of electric shock. In series or parallel setups, you achieve higher voltages and currents. Observe the safety information in "[Working with hazardous voltages](#)" on page 9.  
Ensure that all products are grounded by connecting them to the AC power.
2. Connect the LAN socket using an RJ-45 cable to the LAN.  
By default, the R&S HMP uses DCHP that assigns the IP address automatically. If the R&S HMP cannot obtain an IP address automatically, it returns a time-out message after about three minutes and clears the parameters in the "Interface settings" dialog. Possible reasons are that the LAN does not support DCHP or requires a specific TCP/IP configuration, or that the connection is missing.
3. If the time-out message is displayed, proceed as follows:

- a) Check the LAN connection of both, the R&S HMP and the controller PC.
- b) Consult your network administrator to request support and an IP address, if necessary.
- c) If necessary, assign the IP address manually as described in [Section 7.4.1, "LAN interface"](#), on page 78.

If connected and switched on, the R&S HMP indicates the address information and LAN parameters in the "Interface Settings HO732" dialog.

See [Section 5.4.1, "Interface"](#), on page 56. For information on how to control the instrument remotely, see [Section 7.5, "Operating the instrument remotely"](#), on page 83.

### 3.1.9 Connecting a device under test (DUT)

For safety information, see ["Working with hazardous voltages"](#) on page 9.

The R&S HMP series instruments with two, three or four output channels enable you to supply DUTs with power in a wide variety of applications.

As a brief introduction, the following example describes the basic steps to be taken when setting up a measurement.

For specific applications and setups, see [Section 6, "Application examples"](#), on page 61.

#### To connect to the DUT and set up the measurement

It is assumed that the R&S HMP is connected to power, see [Section 3.1.7, "Connecting to power"](#), on page 23.

1. If any output channels are on, press the [Output] key to switch off all channels.
2. To connect the R&S HMP to the DUT, use cables that fulfill the requirements in [Section 3.1.5, "Considerations for test setup"](#), on page 20:
  - a) Connect one cable to the [-] output connector of the channel at the [front panel](#).
  - b) Connect the second cable to the [+] output connector of the same channel.
3. Connect both cables to the DUT.
4. To improve accuracy, connect the sense lines the same way.  
See [Section 6.1, "Compensating voltage drops on the supply lines"](#), on page 61.

Now you can switch on the R&S HMP to configure the setup and start the measurement, see:

- ["To switch on the R&S HMP"](#) on page 26
- ["Selecting the channels"](#) on page 34
- ["Setting the current limit"](#) on page 34
- ["Selecting the output voltage"](#) on page 34
- ["Activating the output"](#) on page 35

### 3.1.10 Switching on and off



For safety reason, switch off at the mains switch when the R&S HMP is not in use.

#### To switch on the R&S HMP

The instrument is off but connected to power, see [Section 3.1.7, "Connecting to power"](#), on page 23.

- ▶ Press the [Power] key at the [front panel](#).

The R&S HMP performs a system check, boots the operating system, and starts the firmware.

It starts up in the operating mode used before the last switch-off.

**Note:** At startup, the instrument turns off all signal outputs to protect a connected DUT (load). This function prevents the DUT from being supplied and even damaged unintentionally caused by the latest instrument settings.

#### To shut down the R&S HMP

- ▶ Press the [Power] key.

The operating system shuts down.

The R&S HMP saves all current instrument settings (nominal values) in non-volatile memory, and restores the settings when you switch it on again.

#### To disconnect from power

The R&S HMP is switched off, i.e. the [Power] key is off.

- ▶ **NOTICE!** Risk of data loss. If you disconnect the product from power when it is in the ready state, you can lose settings and data. Shut it down first.

Disconnect the AC power cable from the socket outlet.

## 3.2 Instrument tour

This section explains the control elements and the connectors of the R&S HMP instruments. The views of the front panel and the rear panel help you to get familiar with the instrument and to perform first steps. For specifications of the interfaces, see the specifications document.

The meanings of the labels on the R&S HMP instruments are described in [Section 1.2, "Labels on the R&S HMP"](#), on page 11.



- The control elements on the front panel light up when you turn them on. In addition, the instrument illuminates keys for navigating or entering settings automatically if necessary.
- The channel keys also change their color. They indicate whether you are in setting mode, have the constant voltage supplied at the outputs, or the channel is in constant current mode.

See [Section 3.4.2, "Means of manual interaction"](#), on page 36 for details.

- [Front panel tour](#).....27
- [Rear panel tour](#).....30

### 3.2.1 Front panel tour

The front panel covers control elements and connectors for connecting and configuring the R&S HMP. The shown views of the R&S HMP2030 and the R&S HMP4040 represent the elements of all instrument models.

On the [rear panel](#), you find further connectors, e.g. remote control interfaces, and the AC supply.

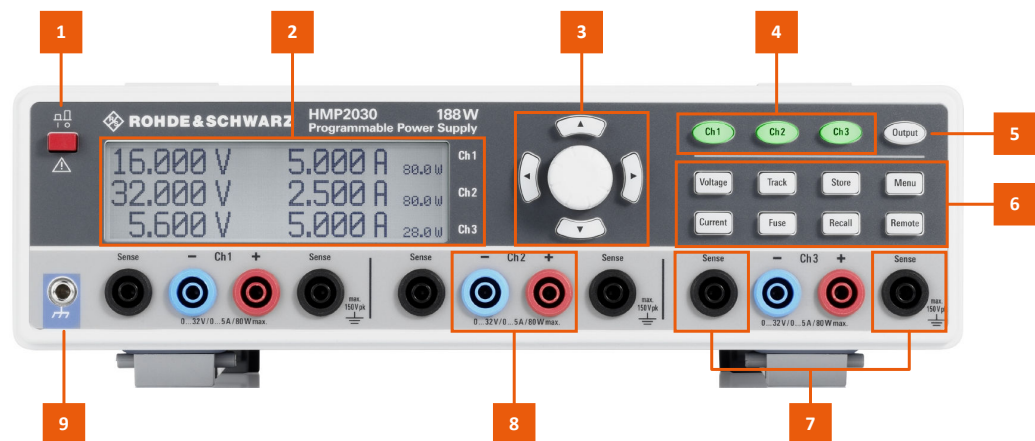

Figure 3-2: Front view of the R&S HMP2030

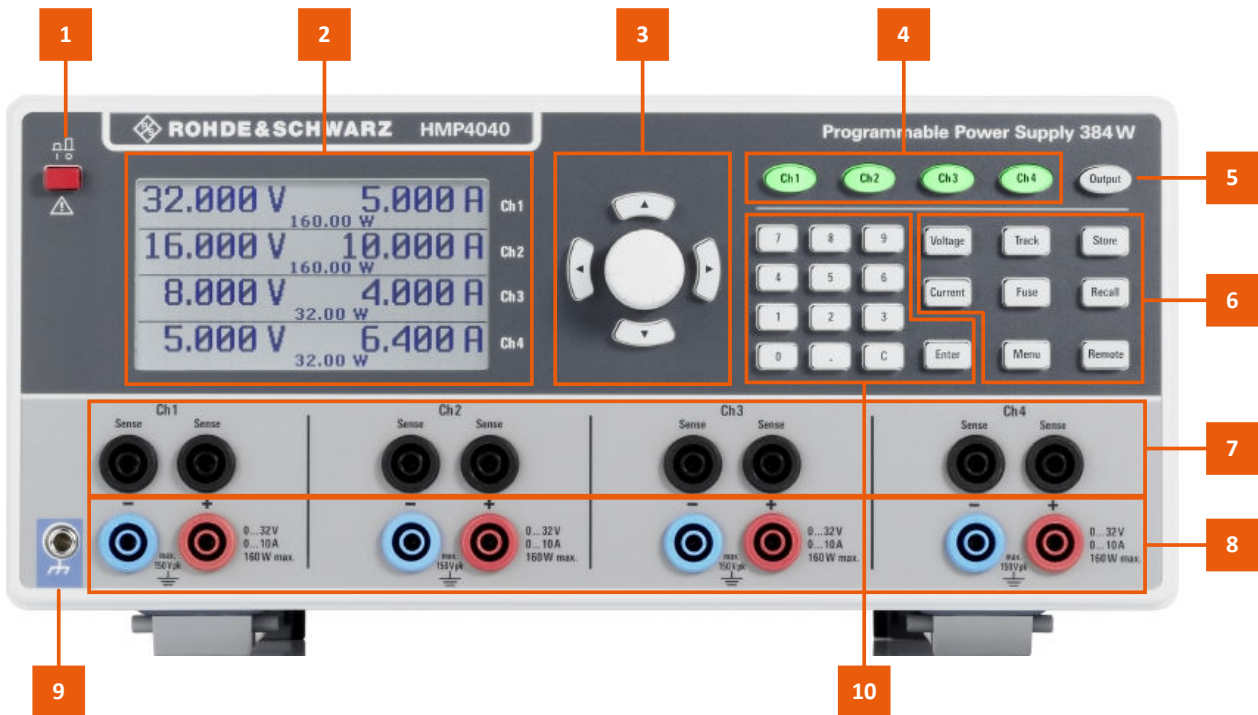

Figure 3-3: Front view of the R&S HMP4040

- 1 = [Power] key, see [Section 3.2.1.1, "\[Power\] key"](#), on page 28.
- 2 = Display, see [Section 3.2.1.2, "Display"](#), on page 28.
- 3 = Navigation controls, see [Section 3.2.1.4, "Navigation controls"](#), on page 29
- 4 = Channel keys, see [System and function keys > Table 3-3](#).
- 5 = [Output] key, see [System and function keys > Table 3-3](#).
- 6 = Function keys, see [System and function keys > Table 3-4](#) and [Table 3-5](#).
- 7 = Sense connectors, see ["Sense"](#) on page 30.
- 8 = Channel output connectors, see ["CHn"](#) on page 30.
- 9 = Protective conductor terminal terminal, see ["Protective conductor terminal"](#) on page 30.
- 10 = [Keypad], see [System and function keys > Table 3-6](#).

### 3.2.1.1 [Power] key

Switches the instrument on and off, see [Section 3.1.10, "Switching on and off"](#), on page 26.

### 3.2.1.2 Display

The LCD screen at the front panel is the graphical user interface.

The initial screen indicates the parameters of up to four output channels, depending on the instrument model. For configuring the instrument functions and settings, the display indicates the corresponding settings dialogs.

### 3.2.1.3 Keys

This section introduces the functionality of the hardkeys at the front panel. These controls lead you to menus and dialogs displayed on the screen. For information on how to operate the instrument, see [Section 3.4.2, "Means of manual interaction"](#), on page 36.

### 3.2.1.4 Navigation controls

The [rotary knob] and [arrow] keys allow you to navigate within the display, and to configure and confirm settings.

**Table 3-2: Navigation controls**

Key	Assigned functions
[rotary knob]	Selects, activates or confirms settings.
[left] / [right] / [up] / [down]	Moves the cursor in entry fields.

### 3.2.1.5 System and function keys

The system and function keys enable you to operate the instrument manually, including measurement and instrument settings.

**Table 3-3: Channel controls**

Key	Assigned functions
[Ch1] <sup>1,2,3,4</sup> [Ch2] <sup>1,2,3,4</sup> [Ch3] <sup>2,3,4</sup> [Ch4] <sup>4</sup>	Selects a channel for output. The number of provided channel keys corresponds to the instrument model.
[Output]	Activates the output of the selected channels.
1) R&S HMP2020 / 2) R&S HMP2030 / 3) R&S HMP4030 / 4) R&S HMP4040	

**Table 3-4: Measurement controls**

Key	Assigned functions
[Voltage]	Sets the output voltage for the selected channel.
[Current]	Sets the current limit for the selected channel.
[Track]	Starts the tracking function.
[Fuse]	Activates the electronic fuse function.

**Table 3-5: Utility controls**

Key	Assigned functions
[Store]	Saves the measurement configuration.
[Recall]	Loads a saved measurement configuration.

Key	Assigned functions
[Menu]	Accesses the list of instrument functions.
[Remote]	Switches between manual and remote control.

**Table 3-6: Keypad <sup>1)</sup>**

Key	Assigned functions
[Keypad]	Sets the nominal values.
[Enter]	Confirms settings.
<sup>1)</sup> R&S HMP4030 & R&S HMP4040	

### 3.2.1.6 Connectors

The channel output connectors are on the [front panel](#).

#### Sense

4 mm safety sockets.

Two connectors provided for each channel are used for compensating lead resistances.

#### CHn

4 mm safety sockets.

Depending on the instrument model, the number of output channels (up to four channels) and the voltage and current range varies. See the labels next to the connectors of each channel.

For detailed specifications, see the specifications document.

#### Protective conductor terminal

Protective ground socket (4 mm banana socket) to secure the R&S HMP, e.g. with a grounded external conductor.

The protective conductor terminal is directly connected to the mains safety ground by the line cord.

See [Section 1.2, "Labels on the R&S HMP"](#), on page 11.

## 3.2.2 Rear panel tour

The rear panel covers the AC power supply, interfaces for remote control and output terminals for connecting the R&S HMP in a rack. The shown rear views of the R&S HMP2030 and the R&S HMP4040 represent the elements for all instrument models (standard equipment).

The interfaces for remote control vary, depending on the equipped option:

- R&S HO732 dual Ethernet / USB interface
- R&S HO720 dual RS232 / USB interface

- R&S HO740 IEE-488 GPIB interface



Figure 3-4: Rear view of the HMP20x0 series



Figure 3-5: Rear view of the HMP40x0 series

- 1 = LAN interface, see ["LAN"](#) on page 32
- 2 = USB type B, see ["USB B"](#) on page 32
- 3 = Power supply, see ["AC supply with fuse holder"](#) on page 33
- 4 = Voltage selector, see ["AC power supply voltage selector switch"](#) on page 33
- 5 = Terminal block, see ["Rear panel connector"](#) on page 32

### 3.2.2.1 Connectors

#### LAN

Option: R&S HO732

RJ-45 connector to connect the R&S HMP to a LAN for remote control, remote operation, and data transfer.

See [Section 3.1.8, "Connecting to LAN"](#), on page 24.

#### USB B

Option: R&S HO732, R&S HO720

Female USB (universal serial bus) type B connector. This interface provides remote control of the instrument from a controller PC.

See [Section 7.1.2, "USB interface"](#), on page 71.

#### RS-232

Option: R&S HO732

Serial interface to connect a computer for remote control or data transfer.

See ["To establish an RS-232 remote control connection"](#) on page 77 ["To establish a GPIB remote control connection"](#) on page 78.

For information on the pin assignment, see [Section A.2, "RS-232"](#), on page 115

#### GPIB Interface IEEE-488

Option: R&S HO740

General purpose interface bus (GPIB) interface to connect a computer for remote control of the R&S HMP.

See ["To establish a GPIB remote control connection"](#) on page 78.

For the pin assignment of the interface, see [Section A.1, "GPIB"](#), on page 114.

#### Rear panel connector

Rear panel output connector for connecting the R&S HMP in 19" rack systems.

Depending on the instrument model, the instrument provides up to two 8-pin connector blocks. A connector block covers four lines for voltage and current sense signals for each channel.

### 3.2.2.2 AC power supply

#### AC supply with fuse holder

Mains power supply with fuse holder and IEC socket.

- Fuse holder  
Socket for the fuse securing the source voltage. Depending on the power supply system, the corresponding fuse must be plugged before connecting to power.  
See ["To change the fuses"](#) on page 22.
- IEC socket  
Power supply connector for connecting the R&S HMP to the mains.  
See [Section 3.1.7, "Connecting to power"](#), on page 23.

#### AC power supply voltage selector switch

Switch for selecting the line voltage 115 V or 230 V.

See ["To set the supplied mains voltage"](#) on page 23.

## 3.3 Trying out the instrument

This section describes the first steps with the R&S HMP. It shows a simple configuration for providing the power at the output. For basics on operating the instrument, see [Section 3.4, "Instrument control"](#), on page 35.

#### Prerequisites

- The instrument is set up, connected to the mains, and started up as described in [Section 3.1, "Preparing for use"](#), on page 17.
- Before you connect and activate a load:
  - Make sure that you have deactivated the corresponding output of the R&S HMP to prevent unintended transient currents. Follow this order to get an optimal transition behavior when activating the output.
  - Set the current limit to prevent damage to the test circuit in case any error occurs (e.g. as a short circuit), see ["Setting the current limit"](#) on page 34.
- Make sure to operate highly sensitive semiconductors, such as laser diodes, only as specified by the manufacturer.
- Before trying out the instrument, note the maximum voltage, current and power ranges given in the specifications document.  
See also [Section 5.1, "About the output modes of the R&S HMP"](#), on page 43.

We recommend that you follow the sequence of steps given in this description before you activate an output.

The instructions describe the manual control with the rotary knob and the arrow keys, setting the channel 1. Before trying out, observe the safety instructions and maximum specification.

For information on the settings and the corresponding remote control commands, see [Section 5, "Instrument functions"](#), on page 43.

### Selecting the channels

- ▶ Press the channel key, e.g. [Ch1].  
An active channel key lights green.

### Selecting the output voltage

1. Press the [Voltage] key.  
The [Voltage] key and the arrow keys are lighting, indicating that they are active.  
For information on the color coding, see [Section 3.4.2.2, "Characteristics of setting controls"](#), on page 37.
2. Press the channel key, e.g. [Ch1].  
Activates the voltage setting. The [Ch1] key lights blue.
3. Set the output voltage value by turning the [rotary knob].  
The R&S HMP applies the setting immediately.
4. To terminate the setting, press the [Voltage] key.  
The [Ch1]key illuminates green again.  
**Tip:** If you do not terminate with the [Voltage] key, the instrument exits the setting mode after the key fallback time has elapsed, see ["Key fallback time"](#) on page 57.

### Setting the current limit

1. Press the [Current] key.
2. Press the [Ch1] key.  
The current setting in the display is in edit mode.
3. Set the current limit value.  
The R&S HMP applies the setting immediately.
4. Press the [Current] key to terminate the setting mode.  
If you do not press the [Current] key, the instrument automatically exits the setting mode after the key fallback time has elapsed.  
See ["Key fallback time"](#) on page 57.

### Activating the fuse

The R&S HMP series includes an electronic fuse function that enables you to protect a connected sensitive test circuit even better from damage.

1. Press the [Fuse] key.  
The R&S HMP activates the fuse function.
2. Press the [Ch1] key to activate the fuse.  
The R&S HMP immediately applies the setting and indicates the activated fuse in the display.  
After the fallback time has elapsed, the instrument exits the setting mode.

See "[Key fallback time](#)" on page 57.

- Repeat step 1 and step 2 to disable the fuse function.

### Activating the output

You can turn on and off the output voltages regardless of the operating mode the instrument is in.

- Press the [Ch1] key.
- Press the [Output] key.

The [Output] key turns on the outputs of all activated channels and supplies the connected loads.

### Saving instrument settings

You can save up to 10 measurement configurations in the memory locations provided by the instrument.

- Press the [Store] key.  
The "Store Settings" dialog opens.
- Use the [rotary knob] to select the memory location.
- Confirm with the [rotary knob].
- Return with the [Store] key.

The R&S HMP saves the settings. Previous settings are overwritten.

### Recalling instrument settings

To retrieve a saved configuration:

- Press the [Recall] key.
- Use the [rotary knob] to select the memory location.
- Press the [rotary knob] again to load the configuration.
- To exit the "Recall Settings" dialog, press the [Recall] key.

## 3.4 Instrument control

This section provides an overview on how to work with the R&S HMP.

It covers the following topics:

- [Ways to operate the instrument](#)..... 36
- [Means of manual interaction](#)..... 36
- [Entering data](#)..... 40
- [Remote control](#)..... 40

### 3.4.1 Ways to operate the instrument

You can operate an R&S HMP in two ways:

- **Manual operation**  
Use the front panel controls to configure your test setup. The principles of manual operation are explained in [Section 3.4.2, "Means of manual interaction"](#), on page 36.
- **Remote control**  
Create programs to automatize repeating settings, tests and measurements. A controller PC with remote access to the instrument runs the programs. See [Section 3.4.4, "Remote control"](#), on page 40 for an overview of the interfaces provided for remote control.

### 3.4.2 Means of manual interaction

For manual interaction with the R&S HMP, use the front panel controls, see [Section 3.2.1, "Front panel tour"](#), on page 27. The display shows the current settings, menus and dialogs, when you perform your settings.

- **Settings controls**  
The system and function keys on the front panel provide all functions and controls to operate the instrument, see [Section 3.4.2.2, "Characteristics of setting controls"](#), on page 37.
- **Navigation controls**  
The navigation controls include the [rotary knob] and [arrow] keys. The [rotary knob] allows you to navigate on the home screen or in dialogs, and to set parameters. The [arrow] move the cursor in entry fields.

#### 3.4.2.1 Understanding the display information

- **Home screen**  
The initial screen shows the power parameters applied to the corresponding channel output.

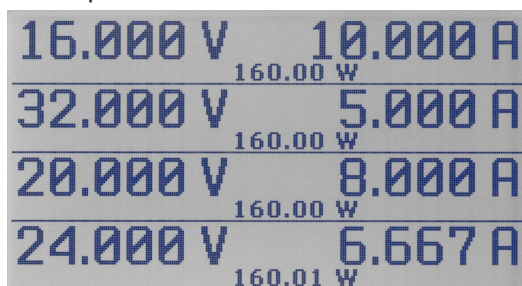

Figure 3-6: Home screen example

- **Setting dialogs**  
Cover the setting parameters of the specific functions.



Figure 3-7: Settings dialog example

- **Selection lists**

List parameters or functions, or lead to setting dialogs.

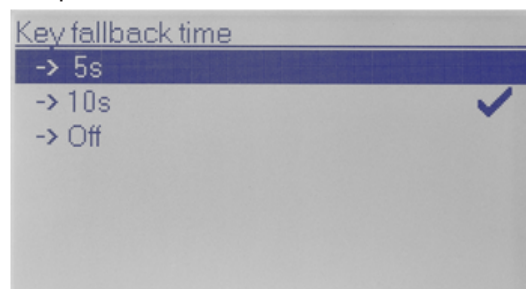

Figure 3-8: Selection list example

### 3.4.2.2 Characteristics of setting controls

All system and function keys are backlit keys, indicating, e.g. the operating mode of a channel, or an active function.

#### Channel keys

Enable you to configure a channel. The keys light up in different colors indicating their current activities or states.

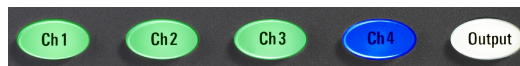

Figure 3-9: Example of the lighting channel and output keys of the R&S HMP4040

Table 3-7: Colors of channel keys

Color	State
Green	The channel is in constant voltage mode (CV)
Red	The channel is in constant current mode (CC), i.e. the current limit is active

Color	State
Blue	The channel is in setting mode, i.e. a function is activated.
Flashing	If the [Output] key and the [Voltage] key are active, and you change a setting of a channel, the color changes depending on the operating mode: <ul style="list-style-type: none"> <li>• <b>Blue / Green:</b> CV = constant voltage.</li> <li>• <b>Blue / Red:</b> CC = constant current.</li> </ul>

### Function keys

*Table 3-8: Colors of function keys*

Color	State
White	The function or operating mode is activated
Off	The function or operating mode is not active.

### Navigation controls

The navigation controls include a [rotary knob] and [arrow] keys. They allow you to navigate within a setting, menus or dialogs.



When you select a function key, e.g. the [Voltage] key, the [arrow] keys light up, indicating that they are usable for input.

- Rotary knob
  - The [rotary knob] has several functions:
    - Moves the selection, e.g. to a parameter in a settings dialog.
    - Activates the edit mode of a parameter.
    - Increments (clockwise direction) or decrements (counterclockwise direction) the instrument parameter of a numeric entry with a defined step size.
    - Acts like the [Enter] key, when it is pressed
- Arrow keys
  - Move the selection up and down, or forward and backward, e.g. to a parameter in a settings dialog
  - Return to a previous menu level ([left] arrow key)
  - In a numeric entry field, increase or decrease the value, or move between the digits.



If you enter the voltage or current limit value with the [rotary knob], the R&S HMP immediately applies the set value. It exits the setting mode automatically, after the fallback time has elapsed, or you can manually exit the setting mode by pressing the corresponding function key.

Settings in menus are not affected by the fallback time. Either you confirm a setting, or return using the [arrow] keys.

See "[Key fallback time](#)" on page 57.

### Numerical Keypad

The instrument models R&S HMP4030 and R&S HMP4040 provide a keypad on the front panel, to enter numerical values.



Figure 3-10: Keypad of the R&S HMP40xx instruments

#### 3.4.2.3 Accessing the functionality

You can access the main functions and parameters, measurement and display modes and configure general instrument settings with the function keys on the front panel. When selected, i.e. a function is active, the corresponding function key lights up.

##### To open a dialog

Instrument functions that are not assigned to a dedicated function key are accessed with the [Menu] key.

1. Press the [Menu] key.  
The R&S HMP displays the main menu.
2. Select the function by turning the [rotary knob].  
Alternatively, use the [arrow] keys.
3. Press the [rotary knob] to confirm the selection.  
The selected dialog opens.

##### To select a parameter in a dialog

1. Open the dialog as described in ["To open a dialog"](#) on page 39.
2. To select the settings parameter, turn the [rotary knob] or use the [arrow] keys.
3. To activate the edit mode for the selected parameter, press the knob.
4. To enter the value, proceed as described in [Section 3.4, "Instrument control"](#), on page 35.

**To close or exit a dialog**

- ▶ Press the [Menu] key.  
The instrument exits the menu mode or returns to the previous menu level.

### 3.4.3 Entering data

To adjust values, you can use either the [rotary knob] or use the [arrow].

**To adjust a numerical value**

For numeric settings, you must select the parameter and activate the edit mode.

1. If not accessible directly, select the item in the provided function list to navigate to the corresponding settings dialog, e.g. as described in "[To open a dialog](#)" on page 39.
2. Select the parameter and activate the edit mode as described in "[To select a parameter in a dialog](#)" on page 39.
3. When the selected parameter is in edit mode, you have the following options to adjust the setting:
  - a) Turn the [rotary knob] to increase or decrease the value.
  - b) Use the [up] and [down] keys to decrease or increase the value.
  - c) Press the [rotary knob] to confirm the value.
4. For R&S HMP40xx instruments:
  - a) Enter the value directly on the keypad.
  - b) Apply with the [Enter] key.
5. Turn the [rotary knob] to increase or decrease the value.  
Alternatively, use the [up] and [down] keys.
6. Press the [rotary knob] to confirm the value.



Values adjusted with the keypad must be applied with the [Enter] key. Otherwise, the instrument disables the edit mode without the changes taking effect.

### 3.4.4 Remote control

In addition to operating the R&S HMP directly on the instrument, it is also possible to operate and control it from a remote PC.

**Remote Control Interfaces**

The R&S HMP supports various interfaces for remote control:

- Dual Ethernet / USB interface, option R&S HO732
- Dual USB / RS232 interface, option R&S HO720
- GPIB Interface IEEE-488, option R&S HO740

To control the instrument remotely, you need one of the listed options installed in your R&S HMP. Drivers and information on their installation are provided for download on the product pages [www.rohde-schwarz.com/product/hmp](http://www.rohde-schwarz.com/product/hmp) and [www.rohde-schwarz.com/product/hmp4000](http://www.rohde-schwarz.com/product/hmp4000).

See [Section 3.1.8, "Connecting to LAN"](#), on page 24 for an example on how to set up a LAN connection for remote control.

## 4 Accessing, retrieving and handling data

Depending on the origin and content, this description distinguishes between the following data types:

- Operational data
- Non-operational data

### **Operational data (data for intended use)**

Your instrument uses and creates this data because of its intended use and according to the settings and configuration you have made. Thus, this data makes up most of the data that the R&S HMP creates, such as user files that contain user-defined configurations, like instrument settings.

The R&S HMP saves this data in the configuration file, see [Section 5.2.3, "Saving and recalling instrument configurations"](#), on page 47.

### **Non-operational data (usage data)**

The R&S HMP does not generate non-operational data during and through its use.

## 5 Instrument functions

This section explains the operating modes, and the operating procedures and advanced functions of the R&S HMP.

The display and the controls on the front of the R&S HMP form the user interface for controlling the instrument manually. The display shows the current settings, and leads you to the dialogs of the corresponding functions.

### 5.1 About the output modes of the R&S HMP

Depending on the connected DUT (load), the R&S HMP works automatically either in the operating mode constant voltage (CV) or constant current (CC). The colors of the channel keys show the current output mode, see [Section 3.4.2.2, "Characteristics of setting controls"](#), on page 37.

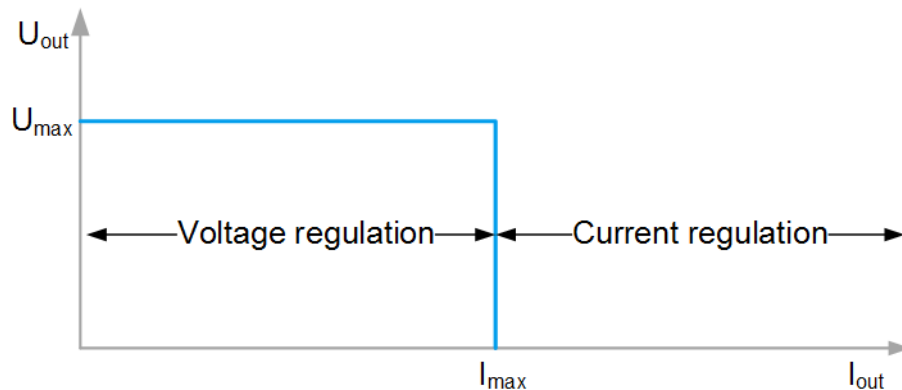

Figure 5-1: R&S HMP output modes

#### CV mode

The CV mode is the standard output mode at power-on.

In this mode, the R&S HMP keeps the voltage  $U_{out}$  constant, while the current can increase to its maximum value  $I_{max}$  (see [Setting  \$I\_{max}\$ , the current limit](#)) if the connected load increases.

#### CC mode

The R&S HMP switches to the CC mode automatically, when the output current exceeds the maximum value  $I_{max}$ . The output mode switches from voltage regulation to current regulation. It keeps the current constant at the limited  $I_{max}$  and decreases the output voltage  $U_{out}$ , i.e.  $U_{out} < U_{set}$ .

### Setting $I_{\max}$ , the current limit

The current limit determines the maximum value  $I_{\max}$  of the output current. Limiting the output current prevents damage to a connected DUT if there is, e.g. short circuit.



Always set  $I_{\max}$  before you take a DUT into operation.

The maximum current  $I_{\max}$  corresponds to the setting with the [Current] key, see "[Setting the current limit](#)" on page 34. The R&S HMP retains this value and automatically restores it at instrument startup.

### Maximum voltage, power and current values

The output voltage ranges from 0 V to 32 V for each channel. Depending on the instrument model, the maximum power and current values vary, see the R&S HMP product brochure for the specification in detail.

In brief, the maximum output current for each channel is 5 A, respectively 10 A, and the maximum output power is 80 W, respectively 160 W.

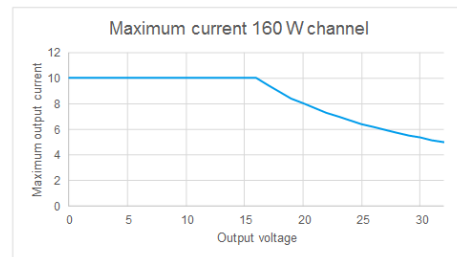
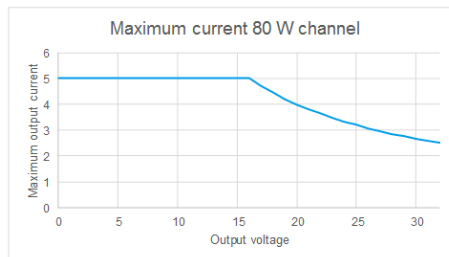

In addition, the maximum output of all channels is limited to 188 W for the HMP2000 series, and 384 W for the HMP4000 series.

If  $U_{\text{out}} > 16$  V, the maximum current decreases according to the formula:

$$I = P / U$$

#### Example: Maximum current of an R&S HMP4040 versus an R&S HMP2030

$$U_{\text{out}} = 24 \text{ V}$$

- R&S HMP4040 with 160 W:  $I_{\max} = 6,67 \text{ A}$
- R&S HMP2030 with 80 W:  $I_{\max} = 3,33 \text{ A}$

### Electronic fuses

For optimum protection of a sensitive DUT, the instruments of the R&S HMP series are equipped with electronic fuses. In addition, you can logically link the electronic fuses of several channels. For information on how to activate fuses, see "[Activating the fuse](#)" on page 34, and [Section 5.3.1, "Fuse settings"](#), on page 47 for fuse linking.

## 5.2 Basic functions

### 5.2.1 Setting the voltage, current and fuse parameters and activating an output

#### Select the channel

Selects one or more channels for setting the parameters. See ["Selecting the channels"](#) on page 34.

Remote command:

`INSTRument[:SElect]` on page 88

`INSTRument:NSElect` on page 88

#### Set the voltage

Sets the voltage for selected channel. See ["Selecting the output voltage"](#) on page 34.

Remote command:

`[SOURce:]VOLTage[:LEVel][:IMMediate][:AMPLitude]` on page 90

`[SOURce:]VOLTage[:LEVel]:STEP[:INCRement]` on page 91

#### Set the current limit

Sets the current for the selected channels. See ["Setting the current limit"](#) on page 34.

Remote command:

`[SOURce:]CURRent[:LEVel][:IMMediate][:AMPLitude]` on page 92

`[SOURce:]CURRent[:LEVel]:STEP[:INCRement]` on page 93

#### Activate the fuse

Enables the electronic fuse for the selected channel. See ["Activating the fuse"](#) on page 34.

Remote command:

`FUSE[:STATe]` on page 98

#### Activating the channel output

Activates the output of the selected channel. See ["Activating the output"](#) on page 35.

Remote command:

`OUTPut[:STATe]` on page 95

### 5.2.2 Using the tracking function

The tracking function allows you to interlink multiple channels. You can adjust the voltage and the current limit values for the linked channels by the same amount simultaneously (see the 1-V position of 3 channels in [Figure 5-2](#)).



Devices with keypad (R&S HMP 40xx series) allow you to set the same value for all linked channels in addition to the amount change.

**To change the voltage or current values by the same amount**

1. Press the [Track] key.
2. Press the [Voltage] key.
3. Press the channel keys of the channels you want to adjust simultaneously.



*Figure 5-2: Changing the 100 mV position for three channels with the tracking function*

With the tracking function activated, the display highlights the digits of the value in all linked channels.

4. On the display, select the digit of the value with the [left]/[right] [arrow] keys.
5. Adjust the value using the [rotary knob] or the [up]/[down] [arrow] keys.
6. Press the [Current] key.
7. Repeat steps 3 to 5 to adjust the current limit values.

During tracking, the R&S HMP retains the previously selected voltage and current difference between the channels until a channel has reached the minimum or maximum value of the voltage or current. The Track key remains activated until it is pressed again. It is not affected by the "Key Fallback Time".

**To set the same voltage or current value for all linked channels**

Performing this setting is only provided by instruments equipped with a keypad:

1. Press the [Track] key.
2. Press the [Voltage] key.
3. Press the channel keys of the channels you want to adjust simultaneously.

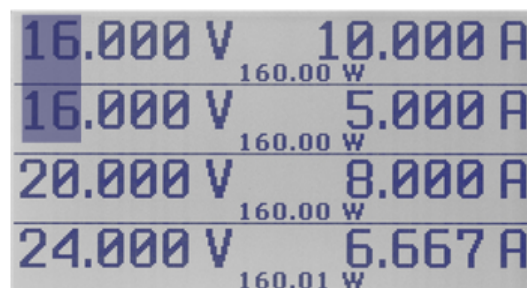

*Figure 5-3: Setting the same voltage for two channels with the tracking function*

4. Set the value using the keypad.
5. Confirm with [Enter].
6. Press the [Current] key.
7. Repeat steps 3 to 5 to adjust the current limit values.

During tracking, the R&S HMP retains the previously selected voltage and current difference between the channels until a channel has reached the minimum or maximum value of the voltage or current. The [Track] key remains activated until it is pressed again. It is not affected by the "Key Fallback Time".

### 5.2.3 Saving and recalling instrument configurations

The remote commands for saving and recalling are described in [Section 8.1, "Common commands"](#), on page 84.

#### Store

Saves up to 10 instrument settings. See "[Saving instrument settings](#)" on page 35.

Remote command:

\*[SAV](#) on page 86

#### Recall

Loads a previously saved instrument setting. See "[Recalling instrument settings](#)" on page 35.

Remote command:

\*[RCL](#) on page 87

## 5.3 Advanced functions

### 5.3.1 Fuse settings

Fuse delay and fuse linking settings enable you to handle a fuse tripped event when it occurs.

#### Fuse linking

The fuse linking function allows you to interlink channels with their electronic fuses logically.

Access:

1. Press the [Menu] key.
2. Select "Fuse Linking" by pressing the [rotary knob] or the [right ][arrow] key.
3. Select the channel by turning the [rotary knob].

- Select the channel on the right to link with the selected channel.

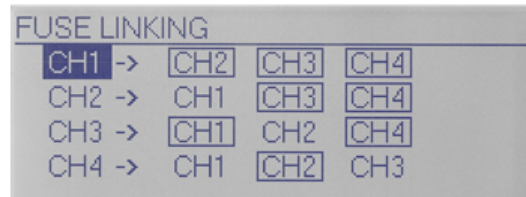

Figure 5-4: Fuse linking (example R&S HMP4040)

- Press the [Menu] key to return to the display screen.

With an activated fuse link, the interlinked channels are switched off, if the current exceeds the current limit.

### Fuse delay

- Press the [Menu] key.
- Select "Fuse Delay" by pressing the [rotary knob] or the [right] [arrow] key.
- Select the channel.
- Set the delay time.

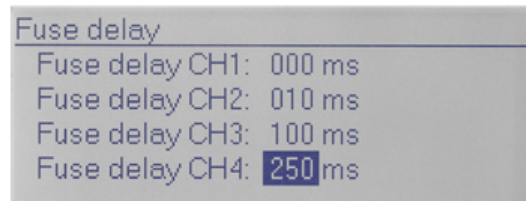

Figure 5-5: Fuse delay (example R&S HMP4040)

The remote commands for setting the fuse parameters are described in [Section 8.7, "FUSE subsystem"](#), on page 95.

<a href="#">Fuse Linking</a> .....	48
<a href="#">Fuse delay</a> .....	49

### Fuse Linking

Sets the channel to interlink the fuse of the selected channel.

When the current for a channel exceeds the value  $I_{max}$  and the electronic fuse trips, all channels interlinked with this channel are turned off also. The Output key remains active.

See "[Activate the fuse](#)" on page 45 on how to activate a fuse in general.

At any time, you can reactivate the channels via the corresponding keys. If any excess current remains, the R&S HMP immediately turns off the output again.

Remote command:

[FUSE:LINK](#) on page 97

[FUSE:UNLink](#) on page 98

**Fuse delay**

Sets a delay for the selected fuse.

The time delay prevents the fuse to trip immediately, e.g. when current peaks above the set current limit occur due to a connected capacitive load.

The range of the fuse delay is 0 ms to 250 ms.

Remote command:

`FUSE:DELay` on page 97

### 5.3.2 Overvoltage protection settings

Overvoltage protection enables you to protect the DUT from damage due to exceeding output voltage. It turns off the output when the voltage exceeds the set  $U_{max}$  in the corresponding channel. Preset to 33 V (factory preset), you can set the OVP to match the requirements of your application.

With firmware version 2.0 and higher, the R&S HMP provides two OVP modes:

- "Measured" mode  
The R&S HMP takes the measured voltage value as a reference threshold for the OVP.
- "Protected" mode  
The R&S HMP takes the voltage value set on the instrument as reference threshold for the OVP.

Access:

1. Press the [Menu] key.
2. Select "Over Voltage Protection" by pressing the [rotary knob] or the [right] [arrow] key.
3. Select the corresponding channel.
4. Set the OVP value using the [rotary knob].
5. Select the OVP mode.
6. Return to the display with the [left] [arrow] key.

When OVP is activated and the output voltage exceeds the set OVP value, the R&S HMP indicates a flashing "OVP" in the corresponding channel and turns off the output of this channel.



Figure 5-6: Overvoltage protection (example R&S HMP2030)

The remote commands for setting the overvoltage parameters are described in Section 8.8, "VOLTage:PROTection subsystem", on page 98.

OVP Level.....	50
OVP Mode.....	50

#### OVP Level

Sets the OVP level for the selected channel.

Remote command:

`VOLTage:PROTection[:LEVel]` on page 100

#### OVP Mode

Sets the OVP mode for the selected channel.

Remote command:

`[SOURce:]VOLTage:PROTection:MODE` on page 100

### 5.3.3 Arbitrary settings

The arbitrary function allows you to define freely programmable waveforms for voltage and current within the limits set by the instrument.

A waveform consists of up to 255 voltage and current value pairs, and a dwell time definable for each value pair. These base parameters enable you to create any of the common waveforms (step function, sawtooth, sine, etc.).



A signal with three specified value pairs leads to a staircase curve, e.g. issued by an A/D converter. To create a sawtooth signal for instance, you must define additional value pairs.

To generate complex voltage sequences, the R&S HMP is suitable to only a limited extent due to the limited number of 128 value pairs and the minimum delay of 10 ms.

The repetition factor allows you to determine how often the waveform is played. If you have the repetition rate set to 000, the R&S HMP repeats the arbitrary function infinitely.

Each channel covers a memory for saving a waveform. To configure a waveform, you can use the control panel or an externally created waveform, e.g. created with the R&S HMEplorer software, available for download on the Internet, see [www.rohde-schwarz.com/software/hmp/](http://www.rohde-schwarz.com/software/hmp/).

The EasyArb editor of the R&S HMEplorer software enables you to create any point of a waveform conveniently, by adding or deleting individual points.

Duration (s)	Voltage (V)	Current (A)	Interpolator
0,00	0,000	1,0000	<input type="checkbox"/>
0,01	0,640	1,0000	<input type="checkbox"/>
0,02	1,280	1,0000	<input type="checkbox"/>
0,03	1,920	1,0000	<input type="checkbox"/>
0,04	2,560	1,0000	<input type="checkbox"/>
0,05	3,200	1,0000	<input type="checkbox"/>
0,06	3,840	1,0000	<input type="checkbox"/>
0,07	4,480	1,0000	<input type="checkbox"/>

**Figure 5-7: Arbitrary-Editor example (excerpt) HMEplorer software**

To activate an arbitrary waveform, transfer the waveforms to the output channels of the R&S HMP, and activate the output. For externally created waveforms, the R&S HMP provides transfer of the data via the interface.

The instrument generates the waveform signal subsequently in each activated channel with a delay of approximately 100 ms from start.



The arbitrary function is intended for use in the individual channels. Synchronization of the arbitrary waveforms across all channels is hardly possible, but they deviate only slightly from each other.

To confirm the created signal, you can issue the signal at the output and view it on an oscilloscope as shown in [Figure 5-8](#).

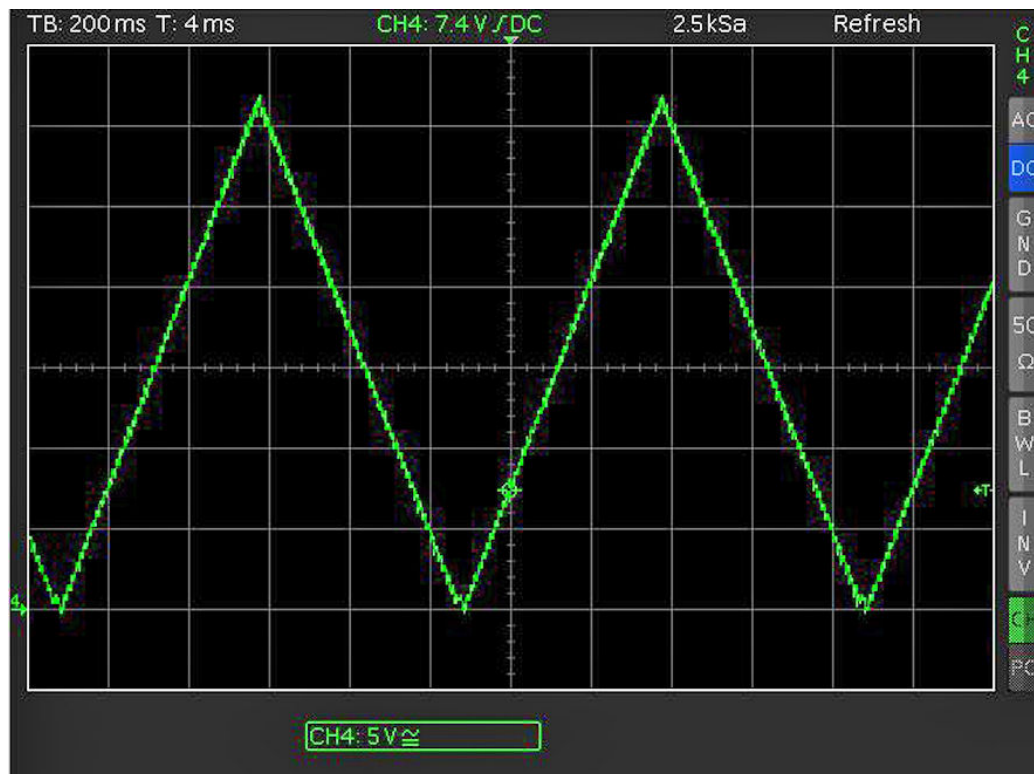

Figure 5-8: Output arbitrary example of an oscilloscope

The following description creates a waveform via the control panel, transmits the waveform to the channels and starts signal generation.

### Creating and saving a waveform

Access:

1. Press the [Menu] key.
2. Select "Arbitrary" by pressing the [rotary knob] or the [right] [arrow] key.
3. In the arbitrary menu, select "Edit Waveform".



Figure 5-9: Arbitrary settings

The "Arbitrary Editor" covers the parameters required to configure the waveform for playback.

4. Select the parameters by pressing the [rotary knob] or the [right] [arrow] key.
5. Enter the values for the corresponding parameters.
6. Repeat the settings for each index entry.

7. When completed, return with the [left] [arrow] key.
8. Select "Save Waveform" to save the data in the internal memory.  
Each channel provides three internal memories for saving waveforms.
9. Select the memory location.
10. Confirm your selection by pressing the [rotary knob].  
The R&S HMP confirms with a message when the waveform data is saved.
11. Select the corresponding parameter, e.g. "Voltage" by pressing the [rotary knob] or the [down] [arrow] key.

### Assigning waveforms to the channels and starting signal generation

To start signal generation based on an arbitrary waveform, proceed as follows:

1. Press the [Menu] key.
2. Select "Arbitrary" and confirm with the [rotary knob].
3. If you have not defined an arbitrary waveform:
  - a) Create a waveform as described in ["Creating and saving a waveform"](#) on page 52
  - b) Load a previously saved waveform from the internal memory with "Recall Waveform".
4. To transfer the waveform to the corresponding channels:
  - a) Select "Transfer Waveform"
  - b) Press the [rotary knob].
  - c) In the "Transfer Arbitrary" dialog, select the channel, e.g. "Channel1"
  - d) Press the [rotary knob].
  - e) Proceed the same way to transfer the waveform to further channels, if necessary.

The R&S HMP confirms the transfer and returns to the "Arbitrary" menu.

5. To start signal generation, select "Start Waveform".
6. Return to the display using the [left] [arrow] key.
7. Turn on the output of the corresponding channel.  
The R&S HMP replays the arbitrary waveform and an icon denotes the active arbitrary function.

The remote commands for setting the arbitrary waveform parameters are described in [Section 8.10, "ARbitrary subsystem"](#), on page 101.

<a href="#">Transfer Waveform</a> .....	54
<a href="#">Start Waveform</a> .....	54
<a href="#">Stop Waveform</a> .....	54
<a href="#">Edit Waveform</a> .....	54
L <a href="#">Index</a> .....	54

L Time.....	54
L Voltage.....	54
L Current.....	54
L Repetitions.....	55
Clear Waveform.....	55
Save Waveform.....	55
Recall Waveform.....	55

**Transfer Waveform**

Selects the channel and assigns the defined waveform.

Remote command:

[ARbitrary:TRANSfer](#) on page 104

**Start Waveform**

Starts the arbitrary waveform for the selected channel.

Remote command:

[ARbitrary:START](#) on page 104

**Stop Waveform**

Stops the arbitrary waveform for the selected channel.

Remote command:

[ARbitrary:STOP](#) on page 104

**Edit Waveform**

Opens the "Arbitrary Editor" to insert the parameters for defining the waveform.

Remote command:

[ARbitrary:DATA](#) on page 103

**Index ← Edit Waveform**

Sets the counter for the value pairs (0...128).

Remote command:

[ARbitrary:DATA](#) on page 103

**Time ← Edit Waveform**

Sets the dwell time for a value pair.

The dwell time defines the duration of the signal of a value pair at the output.

Remote command:

[ARbitrary:DATA](#) on page 103

**Voltage ← Edit Waveform**

Sets the voltage value for the current index entry.

Remote command:

[ARbitrary:DATA](#) on page 103

**Current ← Edit Waveform**

Sets the current value for the index entry.

Remote command:

[ARbitrary:DATA](#) on page 103

#### **Repetitions** ← **Edit Waveform**

Sets the repetition rate for the current index entry.

Remote command:

[ARbitrary:DATA](#) on page 103

#### **Clear Waveform**

Deletes any previously made settings.

Remote command:

[ARbitrary:Clear](#) on page 102

#### **Save Waveform**

Saves up to 3 settings (waveforms)

Remote command:

[ARbitrary:SAVE](#) on page 104

#### **Recall Waveform**

Loads a previously saved waveform.

Remote command:

[ARbitrary:REStore](#) on page 103

## 5.4 General instrument settings

The general instrument settings include basic instrument functions, regardless of the selected operating mode and measurement. Some of these settings like screen display and peripherals are initially configured at the setup of the instrument, according to personal preferences and requirements. However, you can individually adjust the settings at any time, for example, for specific applications.

Access:

1. Press the [Menu] key at the front panel.
2. Select the corresponding setting in the list.

The required remote commands are described in [Section 8.11, "SYSTEM subsystem"](#), on page 105.

• <a href="#">Interface</a> .....	56
• <a href="#">Key &amp; display functions</a> .....	57
• <a href="#">Beeper</a> .....	58
• <a href="#">Information</a> .....	59
• <a href="#">Reset device</a> .....	59
• <a href="#">Firmware update</a> .....	59

### 5.4.1 Interface

Options:

- R&S HO732 dual Ethernet / USB interface
- R&S HO720 dual USB / RS232 interface
- R&S HO740 GPIB Interface IEEE-488

If equipped with one of the options, you can control the R&S HMP remotely either over Ethernet (LAN), USB, RS-232 or the GPIB (IEC/IEEE) bus interface.

Access:

1. Press the [Menu] key.
2. Select "Interface" with the [rotary knob]  
Press the [rotary knob] to open the interface menu list.

In the menu list, you can select the interface, access the corresponding settings and retrieve information on the interface.



As the settings for the dedicated interfaces relate closely to the remote control environment, you find information on connection, protocols and instructions for setting up remote control in [Section 7, "Network operation and remote control"](#), on page 68.

[Section 7.4, "Adjusting the interface addresses"](#), on page 78 covers the setting parameter descriptions for addressing the instrument.

<a href="#">Select interface</a> .....	56
<a href="#">Settings</a> .....	56
<a href="#">Information</a> .....	57

#### Select interface

Selects the interface used to establish a remote connection. The selection list varies depending on the installed remote control interfaces.

"HO720 USB/RS-232"

Option: R&S HO720 dual USB / RS232 interface  
Selects the serial RS-232 interface.

"HO732 Ethernet/USB"

Option: R&S HO732 dual Ethernet / USB interface  
Selects the LAN interface.

"HO740 GPIB Interface IEEE-488"

Option: R&S HO740 GPIB Interface IEEE-488  
Selects the IEEE-488 GPIB bus interface.

#### Settings

Accesses the setting parameters for the selected remote control interface, see:

- [RS-232](#).
- [IP Settings](#).
- [GPIB](#).

**Information**

Displays information on the selected remote control interface.

"Detected Interface:" Installed interface option.

"Ports: [active]" Enabled port of the interface in square brackets.

"Version SW / HW" Currently installed firmware and hardware versions.

**5.4.2 Key & display functions**

Access:

1. Press the [Menu] key.
2. For the R&S HMP4030/4040, select "Display & key"
3. Select the corresponding function with the [rotary knob].

The menu contains a list of functions that enable you to access the advanced functions, see [Section 5.3, "Advanced functions"](#), on page 47. It also provides access to general functions, e.g. to customize the user interface, reset the instrument or retrieve information on the firmware. The following section describes the general setting functions.

<a href="#">Key brightness(R&amp;S HMP2020/2030)</a> .....	57
<a href="#">Key fallback time</a> .....	57
<a href="#">Display contrast</a> .....	58
<a href="#">Display and key brightness</a> .....	58
<a href="#">Brightness fallback time</a> .....	58

**Key brightness(R&S HMP2020/2030)**

Sets the intensity of the key illumination by turning the rotary knob.

**Key fallback time**

Sets the time that elapses before the instrument automatically assigns a changed value and closes the setting mode.

**Example:**

If you change the voltage value of a channel, you can confirm the new value manually, by pressing the [rotary knob]. Alternatively, you can wait until the "Key fallback time" has elapsed, and the HMP confirms the value automatically.

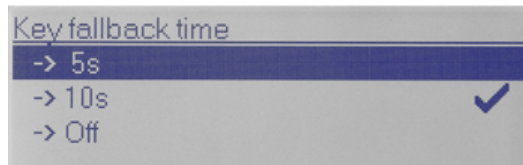

Figure 5-10: Key fallback time (R&S HMP2030)

#### Display contrast

Sets the "Display Contrast" by turning the [rotary knob].

#### Display and key brightness

Provided by the R&S HMP40xx instruments.

Regulates the intensity of the key and display illumination by turning the [rotary knob].

#### Brightness fallback time

Provided by the R&S HMP40xx instruments.

Sets the time that elapses before the instrument automatically reduces the light intensity of the display and keys if you have not changed any settings.

### 5.4.3 Beeper

#### Access

1. Press the [Menu] key.
2. Select "Beeper" by pressing the [rotary knob].

#### Beeper

Selects the mode for the output of an acoustic signal.

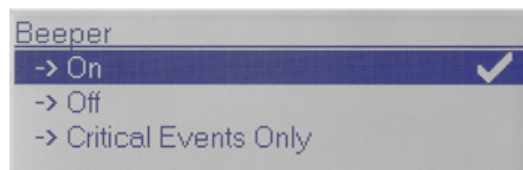

Figure 5-11: Beeper (R&S HMP2030)

"On"                   Beeps every time the key is pressed.

"Off"                   Does not beep on any occasion.

"Critical Events Only"  
                          Beeps when an error occurs.

Remote command:

`SYSTem:BEEPer[:IMMediate]` on page 105

#### 5.4.4 Information

Access:

1. Press the [Menu] key.
2. Select "Information" by pressing the [rotary knob].

This dialog displays instrument information such as instrument model, firmware version and version of the channel firmware.



Deviations of the firmware versions between the instrument firmware and the channel firmware require a firmware update.

#### 5.4.5 Reset device

Access:

1. Press the [Menu] key.
2. Select "Reset device" by pressing the [rotary knob].
3. Select "Yes" by pressing the [rotary knob].

##### **Reset Device**

Resets the instrument to factory state. This function overwrites all user-specific measurement and instrument settings.

**Note:** In remote control mode, the \*RST command sets the instrument to an initial state. It sets the measurement settings to a predefined default.

Basic instrument settings that do not refer to the selected operating mode and measurement are not affected by the \*RST.

Remote command:

\*RST on page 85

#### 5.4.6 Firmware update

You can update the software of the R&S HMP either over USB, or you can use the GPIB interface. Therefore, the instrument must be equipped with one of the following options:

- R&S HO732 dual Ethernet / USB interface  
**Note:** Firmware update over USB is only possible, when you use [CDC](#), the [VCP](#) Virtual COM Port protocol with the corresponding driver installed.
- R&S HO720 dual USB / RS232 interface, only with [USB CDC](#)
- R&S HO740 GPIB Interface IEEE-488

For information on how to update the firmware of the R&S HMP, refer to the release notes. The release notes describe in detail the requirements and the options for updating the firmware.

Useful links:

- [www.rohde-schwarz.com/firmware/hmp](http://www.rohde-schwarz.com/firmware/hmp), provides the latest firmware, with the most recent release notes included for download.
- [www.rohde-schwarz.com/driver/hmp](http://www.rohde-schwarz.com/driver/hmp), provides USB VCP driver
- <https://www.rohde-schwarz.com/>  
Rohde & Schwarz also provides an FAQ for instruments of the R&S HMP series for troubleshooting. For example, if you search for "HMP firmware update" on the Rohde & Schwarz homepage, you find useful information on issues related to the firmware update.

## 6 Application examples

### 6.1 Compensating voltage drops on the supply lines

With the two sense lines, you can compensate up to 1 V voltage drops on the supply lines to the load. Thus the voltage you have set in the R&S HMP applies to the DUT without losses. For the specified maximum sense compensation, see the specifications document.

#### Considerations for sense lines connection

Make sure, that you have no current flowing over the sense lines.

- Use two separate insulated cables that are identical in cross-section and length.
- Set up the connection with identical cable routing, e.g. when you connect the outputs in serial or parallel.

#### To set up the connection of sense lines

1. Connect each cable to the black Sense connectors of the corresponding channel.
2. Connect both cables to the DUT connectors of the source lines, as shown in [Figure 6-1](#)

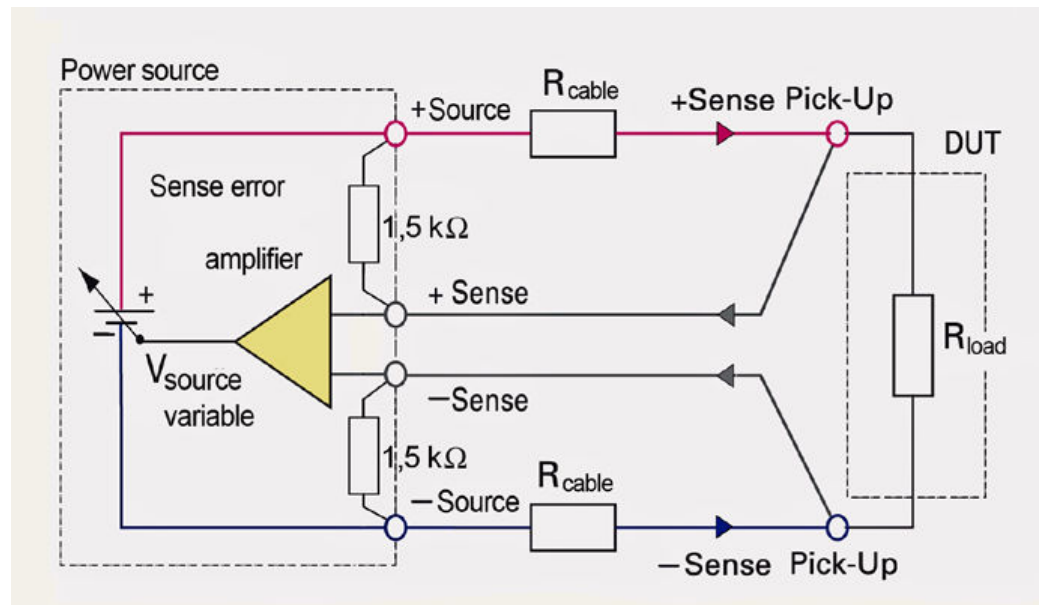

Figure 6-1: Circuit for compensating voltage drops

## 6.2 Operating in parallel and serial mode

Observe the safety information in "[Working with hazardous voltages](#)" on page 9.

Instruments of the R&S HMP series enable you to connect the output channels serially, e.g., to increase the output voltage. Accordingly, to increase the output current, you can connect channels in parallel.

### Considerations for serial and parallel operating modes

- As the output channels of the R&S HMP power supply series are electrically equivalent, only use instruments of the same type. The use of power supplies of different series can damage the instruments, e.g., caused by different overload proof, unevenly distributed currents or compensating current flows within the instruments.
- Output voltage  
The output voltage of the channels connected in serial must not exceed the maximum voltage to ground. Thus, the number of channels, you can connect depends on the maximum output voltage and the used R&S HMP instrument model. See the specifications document for information on the output voltage of each channel, and the maximum output voltage.
- Output power  
If the maximum total instrument power exceeds, the R&S HMP turns off the output automatically, and displays a warning notification. See the specifications document for the specified maximum output power.
- Connectors  
If possible, use the [rear panel connectors](#). The channel outputs at the [rear panel](#) provide lower connection resistance and thus better results.
- Cables  
Use cables with the maximum provided cross-section to minimize the conductor resistance. Make sure that the cables are of the same type and as short as possible.
  - For parallel mode, use cables to the DUT with identical cross-reference and especially the same length.
  - For serial mode, keep the cable connection between the channels as short as possible, to minimize the voltage drop.
- Sense lines  
The sense line connection compensates voltage drops on the supply lines and thus improves the accuracy of the voltage supplied for the DUT. Connect sense lines always the same way as the supply lines. See "[Considerations for sense lines connection](#)" on page 61.
- Switching on the output  
The interconnected output channels must be switched on simultaneously, in particular, if the DUT draws the full current immediately. If more than one instrument is connected, use an external suitable switch that activates the output to the DUT after all channels of the used power supplies are activated.
- Tracking mode

If you change the output voltage in tracking mode and the difference of the currents between the channels is too high, switch to manual mode. See [Section 5.2.2, "Using the tracking function"](#), on page 45.

### 6.2.1 Serial mode

To achieve higher voltages, you can connect the channels of the R&S HMP power supplies in series.

The following interconnection example adds the output voltages of the connected channels. The same current flows through all outputs.

See also ["Considerations for serial and parallel operating modes"](#) on page 62.

#### To set the voltages in the R&S HMP

It is assumed that you have not yet connected the DUT. The R&S HMP is connected to power, see [Section 3.1.7, "Connecting to power"](#), on page 23 and switched on, see [Section 3.1.10, "Switching on and off"](#), on page 26.

1. If activated, press the [Output] key to turn off the output at all channels.
2. Set the current limits for all output channels to the same value, to distribute the output voltage evenly.  
Proceed as described in ["Setting the current limit"](#) on page 34.
3. Set the output voltage for all channels to the same value.  
See ["Selecting the output voltage"](#) on page 34.
4. **NOTICE!** Risk of DUT damage. Exceeding output voltage can damage the connected load (DUT). If one of the outputs exceeds the current limit, the total voltage collapses.

Activate overvoltage protection for all connected channels, see [Section 5.3.2, "Overvoltage protection settings"](#), on page 49.

See the specifications document for information on the output current of each channel.

The R&S HMP turns off the output when the voltage exceeds the set  $U_{\max}$ .

#### To connect the output channels in series

This example shows all four output channels of an R&S HMP4040 power supply wired in series.

1. **WARNING!** Risk of electric shock. For the series connection of several output voltages, hazardous voltages can be applied at the output. Observe the safety information in ["Working with hazardous voltages"](#) on page 9.

Connect the [+] output connector of the first channel with the [-] output connector of the second channel, as shown in [Figure 6-2](#).

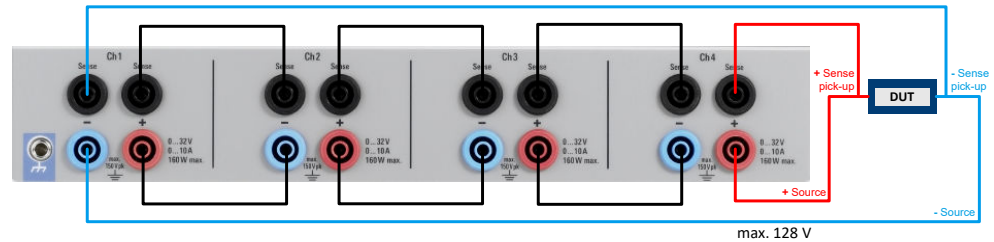

Figure 6-2: Example of a serial connection

2. Repeat [step 1](#) for all channels you want to connect in series.
3. Accordingly, connect the sense lines of the channels as shown in the figure.
4. Connect the cable for the DUT to the [-] output connector of the first channel.
5. Connect the second cable for the DUT to the [+] output connector of the last output channel.
6. Connect the sense line [-] of the last channel to the source [-] cable connector, and the sense [+] line of the first channel to the source [+] cable connector accordingly.
7. Connect both source line cables to the DUT.
8. **NOTICE!** Risk of instrument damage. The protective diodes of a connected but deactivated channel can be overloaded and damage the instrument. Especially, when you have connected a DUT with low resistance.  
Press the [Ch] keys of all connected channels.
9. Press the [Output] key to start the measurement.  
Green lit channel keys indicate the active channels providing power at the outputs in constant voltage mode.

## 6.2.2 Parallel mode

To achieve higher output current, you can connect the channels of the R&S HMP power supplies in parallel. The maximum total current is the sum of the individual currents of all sources connected in parallel.



Anti-parallel connection to supply the DUT with positive and negative voltage is not possible.

Contact the Rohde & Schwarz customer support center for expert help on specific applications.

See [Section 9.4, "Contacting customer support"](#), on page 110.

See also ["Considerations for serial and parallel operating modes"](#) on page 62.

### To set the output current in the R&S HMP

It is assumed that you have not yet connected the load. The R&S HMP is connected to power, see [Section 3.1.7, "Connecting to power"](#), on page 23 and switched on, see [Section 3.1.10, "Switching on and off"](#), on page 26.

1. If activated, press the [Output] key to turn off the output at all channels.
2. **NOTICE!** Risk of instrument damage. Overheating due to insufficient heat dissipation can damage the semiconductors. Observe the current limits in parallel operation as specified in the specifications document.  
Distribute the total current to the connected channels proportionally. To set the current limit, proceed as described in ["Setting the current limit"](#) on page 34.
3. Set the output voltage for all channels to the same value.  
See ["Selecting the output voltage"](#) on page 34.
4. **NOTICE!** Tolerances can cause voltage deviations. Due to tolerances, the voltages in the channels differ slightly.

To compensate the deviations, charge the first voltage output up to the current limit, i.e. to achieve the highest output voltage.

**Example:** If you increase the voltage of a channel by some mV, e.g., to compensate the voltage drop of a set of identical cables, this channel initially provides the current. The output channels connected in parallel supply the remaining current.

### To connect the output channels in parallel

This example shows all four output channels of an R&S HMP4040 power supply wired in parallel.

Always use insulated wires for connecting the channel outputs.

1. **WARNING!** Risk of electric shock. For the parallel connection of several output voltages, hazardous voltages can be applied at the output. Observe the safety information in ["Working with hazardous voltages"](#) on page 9.  
If activated, press the [Output] key to turn off the output at all channels.
2. As shown in [Figure 6-3](#), connect the [+] output connectors of all channels.

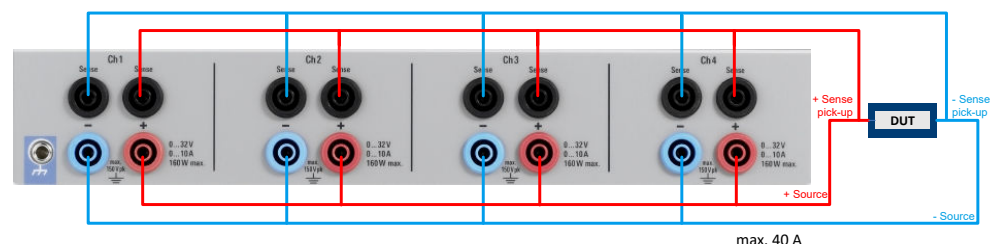

*Figure 6-3: Example of a parallel connection*

3. Connect the [-] output connectors the same way.
4. To compensate unwanted pumping or regulation effects, connect sense lines in your test setup.

- Similarly to the source lines, connect the sense lines to each channel in parallel, as shown in [Figure 6-3](#).

Make sure that no current flows over the sense line.

- Connect the sense [-] line to the source [-] cable connector, and the sense [+] line to the source [+] cable connector accordingly.
- Connect both source cable ends to the DUT.
- Press the [Ch] keys of all connected channels.
- Press the [Output] key to start the measurement.

Green lit channel keys indicate the active channels providing power at the outputs in constant voltage mode.

### 6.3 Multi-Quadrant operation

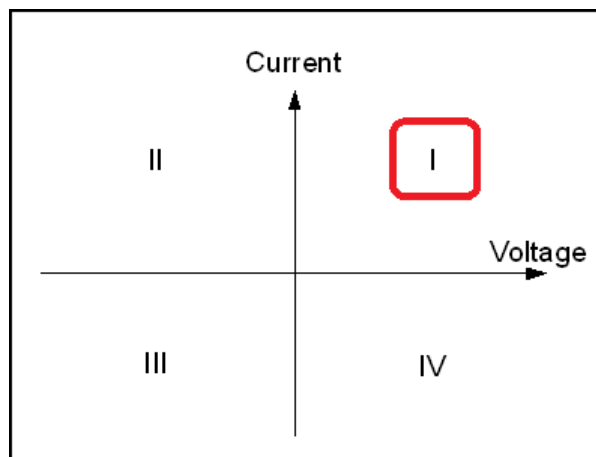

*Figure 6-4: Power supply quadrants diagram*

Operating in multi-quadrant mode requires a multi-quadrant power supply. The R&S HMP power supply is only a 1-quadrant power supply which is able to provide positive voltage or positive current (quadrant I).

But you can generate a negative voltage by connecting two channels with common GND as shown in [Figure 6-5](#). This setup achieves a voltage range between -32 V and +32 V. A negative current (current sink) is not possible.

#### To set up the R&S HMP for multi-quadrant operation

It is assumed that you have not yet connected the load. The R&S HMP is connected to power, see [Section 3.1.7, "Connecting to power"](#), on page 23 and switched on, see [Section 3.1.10, "Switching on and off"](#), on page 26.

Always use insulated cables for connection.

- If activated, press the [Output] key to turn off the output at all channels.

2. To ground the channels:
  - a) Connect the [+] output connector of the first channel with the [-] output connector of the second channel.
  - b) Connect the Sense [+] connector of the first channel to the connector of the [+] output cable.
  - c) Accordingly, connect the Sense [-] connector of the second channel to the connector of the [-] output cable.

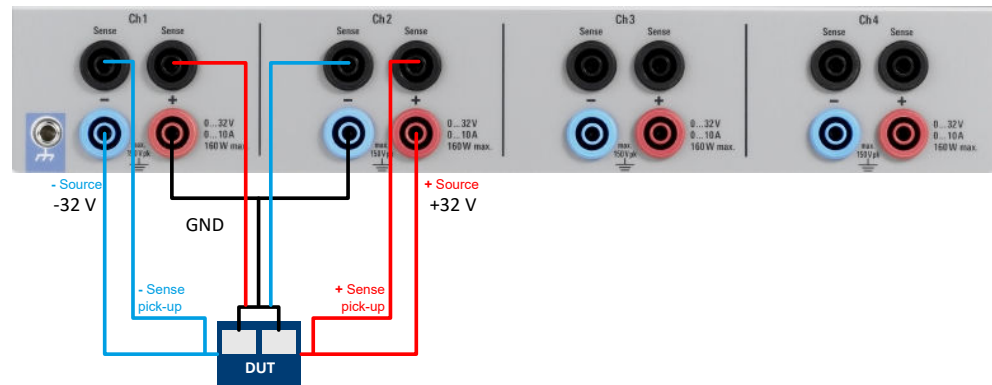

Figure 6-5: Example of a multi-quadrant connection

3. To set up the source line connection, also including sense lines:
  - a) Connect the cable for the DUT to the [-] output connector of the first channel.
  - b) Connect the second cable for the DUT to the [+] output connector of the second output channel.
  - c) Connect a cable to the [-] Sense connector of the first channel, and a second cable to the [+] Sense connector.
  - d) Connect the sense [-] line to the source [-] cable connector, and the sense [+] line to the source [+] cable connector accordingly.
4. To connect the DUT to the R&S HMP:
  - a) Connect both ground cables to the DUT, as shown in [Figure 6-5](#).
  - b) Connect both source line cables to the DUT.
5. When you have established the connection, set the output voltage in the R&S HMP.  
See "[Selecting the output voltage](#)" on page 34.
6. If necessary, activate the electronic fuses for the used channels as described in "[Activating the fuse](#)" on page 34.
7. Press the [Ch] keys of all connected channels.
8. Press the [Output] key to start the measurement.  
Green lit channel keys indicate the active channels providing power at the outputs in constant voltage mode.

## 7 Network operation and remote control

As an alternative to the interactive operation directly at the instrument, you can operate the R&S HMP also from a remote control location, for example a controller PC.

The various interfaces provide flexible access to the instrument. [Figure 7-1](#) shows the possibilities of the physical connection (interfaces) for remote access.



The following descriptions provide information required for operating the R&S HMP remotely. The information applies to all applications and operating modes supported by the instrument. Definitions specified in the SCPI standard are not provided.

For basic knowledge on remote control operation and additional information, see the documents available from the Rohde & Schwarz website:

- [Remote control via SCPI](#)
- [1MA171: How to use Rohde & Schwarz Instruments in MATLAB](#)
- [1SL374: How to communicate with R&S devices using VISA](#)
- [Rohde-Schwarz - Remote control examples](#)

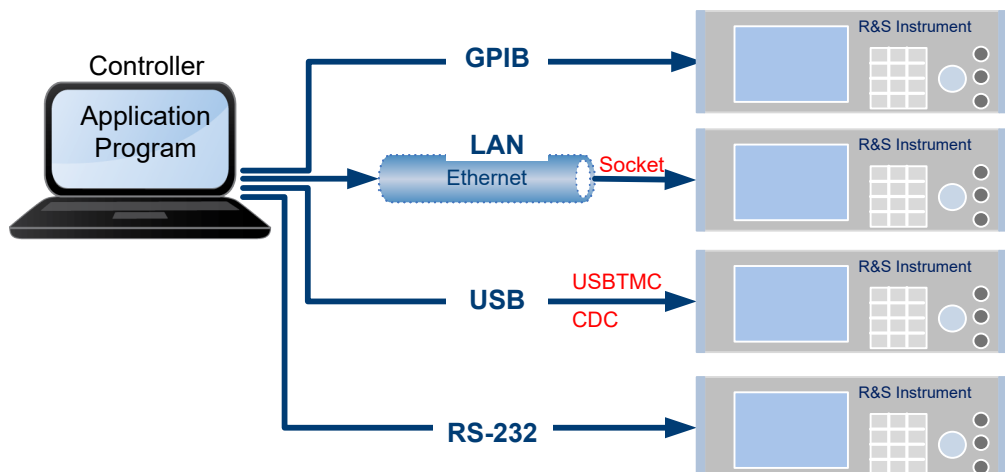

*Figure 7-1: Supported remote connections*

### 7.1 Remote control interfaces and protocols

For controlling the R&S HMP remotely, the R&S HMP must be equipped with one of the provided interfaces:

- Ethernet (LAN) / USB dual interface (optional R&S HO732)
- RS-232 / USB dual interface (optional R&S HO720)
- IEE-488 (GPIB) interface (optional R&S HO740)



A R&S HMP provides one slot for the interface modules, i.e. you can only have one of the modules installed.

You need a connection between the R&S HMP the instrument and the controller PC. An application software that supports communication over the used interface must be installed on the controller PC. [Table 7-1](#) gives an overview on the connectivity:

**Table 7-1: Remote control interfaces and protocols**

Interface	Protocols, VISA <sup>*)</sup> address string and library	Remarks
Local area network (LAN)	<ul style="list-style-type: none"> <li><b>Socket communication</b> (Raw socket) TCP/IP::host address[:: LAN device name]::&lt;port&gt;::SOCKET VISA or socket controller</li> </ul>	<p>The LAN connector is at the <a href="#">rear panel</a> of the instrument.</p> <p>The interface is based on TCP/IP, see <a href="#">Section 7.1.1, "LAN interface"</a>, on page 69 for details on the address information.</p>
USB	<ul style="list-style-type: none"> <li><b>USBTMC</b> USB::&lt;vendor ID&gt;::&lt;product ID&gt;:: &lt;serial number&gt;[:INSTR] VISA</li> <li><b>CDC</b> (communications device class, corresponds to VCP (virtual COM port))</li> </ul>	<p>The USB B connector is at the <a href="#">rear panel</a> of the instrument.</p> <p>For a description of the interface, see <a href="#">Section 7.1.2, "USB interface"</a>, on page 71</p>
GPIB (IEC/IEEE Bus Interface) (option R&S HO740)	<ul style="list-style-type: none"> <li>– GPIB::&lt;address&gt;[:INSTR] (no secondary address) VISA (optional)</li> </ul>	<p>The optional GPIB bus interface according to standard IEC 625.1/IEEE 488.1 is at the <a href="#">rear panel</a> of the instrument.</p> <p>For a description of the interface, see <a href="#">Section 7.1.4, "GPIB interface (IEC/IEEE bus interface)"</a>, on page 72.</p>

<sup>\*)</sup> VISA (Virtual Instrument Software Architecture) is a standardized software interface library providing input and output functions to communicate with instruments. A VISA installation on the controller is a prerequisite for remote control over LAN and USB interface. For remote control over socket communication VISA installation is optional. When using socket communication or the GPIB interface, VISA installation is optional. For basic information, see [Remote control via SCPI](#).



Rohde & Schwarz provides the standardized I/O software library R&S VISA for download at the Rohde & Schwarz website <http://www.rohde-schwarz.com/rsvisa>.

How to: see [Section 7.3, "Connecting the R&S HMP for remote control"](#), on page 77 and [Section 7.4, "Adjusting the interface addresses"](#), on page 78.

• <a href="#">LAN interface</a> .....	69
• <a href="#">USB interface</a> .....	71
• <a href="#">RS-232 interface</a> .....	72
• <a href="#">GPIB interface (IEC/IEEE bus interface)</a> .....	72
• <a href="#">Status reporting system</a> .....	73

### 7.1.1 LAN interface

Option: R&S HO732 dual Ethernet / USB interface

For remote control, the PC and the instrument must be connected over the LAN interface to a common network with TCP/IP network protocol. The instruments are connec-

ted with a commercial RJ45 cable (shielded or unshielded twisted-pair CAT5e), see [Section 3.1.8, "Connecting to LAN"](#), on page 24.

The TCP/IP network protocol and the supported network services are preconfigured on the instrument. Software for instrument control and (for specified protocols only) the VISA program library must be installed on the controller.



### Identifying instruments in a network

If several instruments are connected to the network, each instrument has its own IP address and associated resource string. The controller identifies these instruments by the resource string.

#### 7.1.1.1 VISA resource strings

The VISA resource string is required to establish a communication session between the controller and the instrument in the LAN. The resource string is a unique identifier, composed of the specific IP address of the instrument and some network and VISA-specific keywords.

##### IP address

TCPIP::[host address](#)::[port](#)::SOCKET

TCPIP	= Designates the network protocol
host address	= Designates the IP address or hostname of the instrument
port	= Determines the used port number
SOCKET	= Indicates the raw network socket resource class

The **IP address** (host address/hostname) is used by the programs to identify and control the instrument. It is automatically assigned by the DHCP server the first time the instrument is registered in the network.

The R&S HMP indicates the IP address in the [Section 7.2, "Remote access settings"](#), on page 75 dialog. You can also adjust the IP address manually, see [Section 7.4.1, "LAN interface"](#), on page 78.

Socket communication requires the specification of the port (commonly referred to as port number) and of "SOCKET" to complete the resource string.

The registered port for socket communication is port 5025.

##### Example:

```
TCPIP:::192.1.2.3:::5025:::SOCKET
```

To assign a user-specific port number, see [Section 7.4.1, "LAN interface"](#), on page 78.

For information on how to set up a network LAN connection, see [Section 3.1.8, "Connecting to LAN"](#), on page 24.

## 7.1.2 USB interface

Option:

- R&S HO732 dual Ethernet / USB interface or
- R&S HO720 dual USB / RS232 interface

For remote control using USB, the PC and the instrument must be connected over the USB B interface.

The USB B connector is at the [rear panel](#) of the instrument.

On the controller, you need to install an application for instrument control and, e.g. a VISA program library. VISA detects and configures the Rohde & Schwarz instrument automatically when the USB connection is established.

You can communicate with the instrument over the USB TMC class or the CDC class protocols:

- **USBTMC**  
(USB Test & Measurement Class Specification) is a protocol that is built on top of USB for communication with USB devices, like GPIB. It defines class code information of the instrument. The class code information identifies its functionality to load the respective device driver. Using VISA library, it supports service request trigger, and other specific operations, similar to GPIB.  
For control, you can use the SCPI terminal function of the R&S HMEplorer software. This software also provides logging of measurement values, or graphical display.
- **CDC**  
(Communications Device Class, also known as **VCP** Virtual COM Port) is a protocol used for emulating serial ports over USB. Using the CDC protocol, you have to install the "HO720 / HO730 Virtual COM Port" driver and activate it in the PC device explorer. The driver is available for download on the Rohde & Schwarz product page at [www.rohde-schwarz.com/driver/hmp/](http://www.rohde-schwarz.com/driver/hmp/).  
See [Section 7.4.2, "USB interface"](#), on page 81.

### USB resource string

The resource string represents an addressing scheme that is used to establish a communication session with the instrument. It is based on the instrument address and some instrument- and vendor-specific information.

The USB resource string syntax is as follows:

**USB::<vendor ID>::<product ID>::<serial number>[:INSTR]**

USB	= Denotes the used interface
<vendor ID>	= Manufacturer ID for Rohde & Schwarz
<product ID>	= Product identification of the instrument
<serial number>	= Individual serial number at the rear of the instrument
[:INSTR]	= Indicates the instrument resource class (optional)

**Example:**

```
USB::0x0AAD::0x01DD::100001
```

0x0AAD is the vendor ID for Rohde & Schwarz.

0x01DD is the product ID for the R&S HMP.

100001 is the serial number of the particular instrument.

### 7.1.3 RS-232 interface

Option: R&S HO720 dual USB / RS232 interface

If you use the classic RS-232 interface of the R&S HO720, you do not need any driver.

You have two options to communicate over RS-232 interface:

- Handshake enabled  
If you are working with interface handshake (set on both, the R&S HMP and PC), you do not need to insert delays.
- Handshake disabled  
Without handshake, the interface buffer can overflow (e.g. missing commands) and thus cause problems.  
Consider sufficient delays between the commands to make sure that all commands are executed correctly (approx. 50 ms to 100 ms).

To activate the handshake function, see [Section 7.4.3, "RS-232 interface"](#), on page 81.

### 7.1.4 GPIB interface (IEC/IEEE bus interface)

Option: R&S HO740 GPIB Interface IEEE-488

The R&S HMP is optionally available with an integrated GPIB interface. The GPIB interface is at the [rear panel](#).

To control the R&S HMP over the GPIB bus interface, the instrument and the controller must be connected with a GPIB bus cable. A GPIB bus card, the card drivers and the program libraries of the used programming language must be provided in the controller.



See [Remote control via SCPI](#) for additional information on the characteristics, control commands and messages of the GPIB interface.

#### GPIB address

The controller addresses the instrument over the GPIB bus channel. GPIB provides channel addresses from 0 to 30. The GPIB address is preset to 20 (factory-set), but you can adjust it according to your network environment, see [Section 7.4.4, "GPIB interface \(IEC/IEEE bus interface\)"](#), on page 82.

The GPIB resource string syntax is as follows:

`GPIB:://<channel>[:INSTR]`

GPIB = Denotes the used interface  
 <channel address> = The used channel  
 [:INSTR] = Indicates the instrument resource class (optional)



If the VISA implementation supports the GPIB interface, you can optionally define the VISA Instrument Control Resource (INSTR). It is used to define the basic operations and attributes for a device, such as reading, writing, or triggering.

**Example:**

`GPIB : : 28`

28 is the selected GPIB bus channel.

## 7.1.5 Status reporting system

The status reporting system saves all information on the current operating state of the instrument and errors which have occurred. This information is stored in the status registers and in the error queue.

### 7.1.5.1 Overview of the R&S HMP status registers

For an overview and general information on the status reporting system of Rohde & Schwarz instruments, refer to [Remote control via SCPI](#). The document describes the structure and contents of the status registers and applications of the status reporting system. See also the SCPI standard documentation for comprehensive information on the standard.

The following sections describe the instrument-specific bit assignments of the operation status and the questionable status registers.

You can query the status of the registers remotely, i.e. over the USB, RS-232, GPIB or LAN interfaces with the commands of the [STATUS subsystem](#).

### 7.1.5.2 Instrument-specific status operation register

The parts of the SCPI status register have different properties and functions.

The following two parts represent a subset of the register with an instrument-specific example. For information on all parts of the status register, see [Remote control via SCPI](#).

- **CONDition**

Queries currently executed actions, e.g. the current instrument status. The returned value is always a decimal number that represents the bit pattern of the queried register.

**Example:** Query the operating mode of the instrument:

`STATUS:QUESTIONABLE:INSTRUMENT:ISUMmary1:COND?`

Response: 1 // (1st bit set) constant current mode On the instrument, the [Ch1] lights red (CC mode)

Response: 2 // (2nd bit set) constant voltage mode E.g. the binary bit pattern of this decimal 2 is 000000000000010.

- **EVENT**

Queries actions and events that have been occurred since the last query. It is set to 1, and changes to 0 when queried.

### 7.1.5.3 Instrument-specific status questionable register

This status register covers information on questionable instrument states. Questionable states occur when the instrument is not operated in compliance with its specifications.

To read the register, use the query commands `STATus:QUESTionable:INSTrument:ISUMmary<ch>:CONDition?` on page 107 or `STATus:QUESTionable[:EVENT]?` on page 107. The remote commands for the operation status register are described in [STATus subsystem](#).

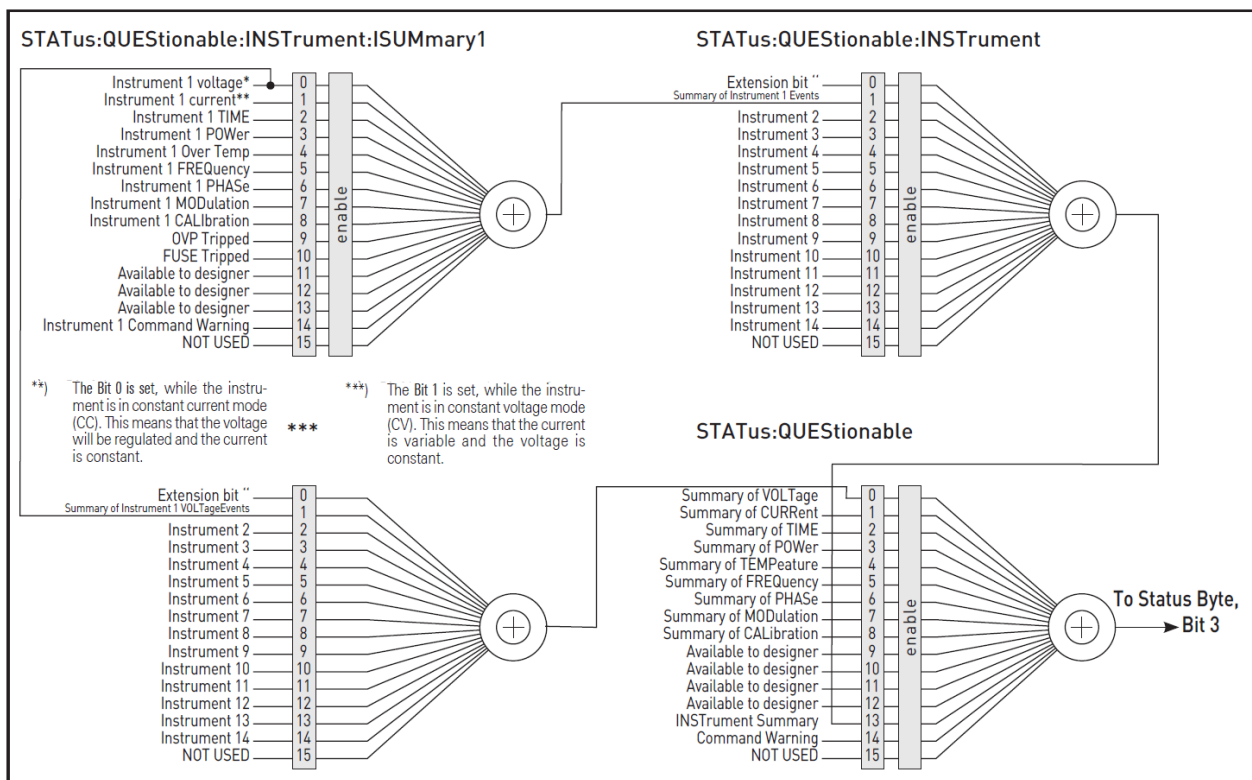

Figure 7-2: Structure of the status questionable register

Each channel of the power supply is considered as separate instrument. Therefore, the number of questionable status registers (`STATus:QUESTionable:INSTrument:ISUMmary<1-n>`) corresponds to the number of the instruments output channels.

**Example:**

The R&S HMP4030 with three 3 channels aligns 3 status registers, distinguished by the number `STATUS:QUESTIONABLE:INSTRUMENT:ISUMmary1` to `STATUS:QUESTIONABLE:INSTRUMENT:ISUMmary3`, as shown in [Figure 7-2](#).

**Table 7-2: Bits of the STATUS:QUESTIONABLE register**

Bit No.	Meaning
0	VOLTage This bit is set while the instrument is in constant current mode (CC). The voltage is regulated and the current is constant.
1	CURRent This bit is set while the instrument is in constant voltage mode (CV). The current is variable and the voltage is constant.
2	Not used
3	Not used
4	TEMPerature overrange This bit is set when a temperature overrange occurs.
5-8	Not used
9	OVP tripped This bit is set if the over voltage protection has tripped.
10	Fuse tripped This bit is set if the fuse protection has tripped.
11 to 15	Not used

## 7.2 Remote access settings

The "Interface" dialog provides access to the settings that address the instrument, including its specific identification parameters and parameters required for the corresponding interfaces.

Access:

1. Press the [Menu] key.
2. Select "Interface" with the [rotary knob]  
Press the [rotary knob] to open the interface dialog.  
In the dialog, the R&S HMP enables you to access the setting parameters of the interfaces the instrument is equipped with.
3. Select "Interface".
4. In the corresponding "Interface settings" dialog, select the interface.
5. To return to the dialog before, press the left key.

6. To select further provided settings, proceed the same way as described before.

IP Settings.....	76
Port Settings /DHCP.....	76
USB Class.....	76
RS-232.....	76
GPIB.....	77

### IP Settings

Option: R&S HO732

Sets the parameters for accessing the instrument remotely over LAN.

"IP Address"	Displays the IP address of the instrument in the network. By default, the R&S HMP is configured to use dynamic TCP/IP configuration and to obtain the whole address information automatically.
"Subnet Mask"	Displays the bit group of the subnet in the host identifier.
"Gateway"	Displays the gateway address. This address identifies the router on the same network as the instrument that is used to forward traffic to destinations beyond the local network.

### Port Settings /DHCP

Option: R&S HO732

Displays the parameters for accessing the instrument remotely over LAN, using the socket port address.

In this dialog, you can deactivate DHCP, if you need to adjust the LAN interface address manually.

"IP Port"	Displays the IP socket port address of the instrument in the network. By default, the IP port address is 5025.
"HTTP Port"	Displays the port address of the commonly used internet communication protocol ( <a href="#">HTTP</a> ).
"DCHP"	Deactivates the <a href="#">DHCP</a> (default setting "ON"). This protocol assigns the address information to the instrument that is connected in the local network automatically.

### USB Class

Option: R&S HO732, R&S HO720

Selects the USB class protocol required for remote control of the instrument over the USB interface.

See also [Section 7.1.2, "USB interface"](#), on page 71

"CDC"	Uses the protocol that emulates a serial port (virtual com port) over USB.
"TMC"	(option R&S HO732 only) Uses the USBTMC (test & measurement class) protocol for communication.

### RS-232

Option: R&S HO720

Sets the parameters for accessing the instrument remotely over the serial RS-232 interface.

"Baud Rate"	Sets the data transmission rate in seconds for the serial remote control interface.
"Number of Stop Bits"	Sets the number of stop bits for the serial remote control interface.
"Parity"	Sets the parity for the serial remote control interface.
"Handshake On/Off"	Activates handshaking for the serial remote control interface.

#### **GPIB**

Option: R&S HO740

Sets the GPIB channel address of the connected instrument.

## **7.3 Connecting the R&S HMP for remote control**

This section briefly explains how to set up the remote control connections for the interfaces provided by the R&S HMP.

### **Establishing a LAN connection**

As remote access over LAN is considered to be the most common connection, you can find the information on how to connect the R&S HMP in the "Getting started" section of this manual.

- ▶ See [Section 3.1.8, "Connecting to LAN"](#), on page 24.

### **To establish a USB remote control connection**

Option: R&S HO732 dual Ethernet / USB or R&S HO720 dual USB / RS232 interface

You can use the USB B interface for remote control from a controller PC. Remote control over USB requires the VISA library, or the corresponding TMC or CDC protocol drivers, see [Section 7.1.2, "USB interface"](#), on page 71. The controller PC and the instrument must be connected at the interface.

The USB B connector is at the [rear panel](#).

- ▶ Connect the USB B connector using a double-shielded USB cable to the controller PC.

VISA detects and configures the instrument automatically when the USB connection is established. You do not have to enter an address string.

### **To establish an RS-232 remote control connection**

Option: R&S HO720 dual USB / RS232

You can use the serial RS-232 interface to control the R&S HMP remotely and for data transfer.

The USB / RS232 connector is at the [rear panel](#). For information on the pin assignment, see [Section A.2, "RS-232"](#), on page 115.

- ▶ Connect the RS-232 (9-pin D-SUB) connector of the R&S HMP to the controller PC with a shielded cable (9 pin, 1:1 wired).

VISA detects and configures the instrument automatically when the USB connection is established. You do not have to enter an address string.

### To establish a GPIB remote control connection

Option: R&S HO720 dual USB / RS232 interface

You can use the GPIB Interface IEEE-488 bus interface to control the R&S HMP remotely.

The GPIB Interface IEEE-488 connector is at the [rear panel](#). For the pin assignment of the interface, see [Section A.1, "GPIB"](#), on page 114.

1. Connect the GPIB Interface IEEE-488 connector of the R&S HMP to the controller PC with a double-shielded GPIB bus interface cable.

The controller must address the instrument with the GPIB bus address, see [Section 7.1.4, "GPIB interface \(IEC/IEEE bus interface\)"](#), on page 72.

2. If necessary, adjust the channel address for remote control as described in [Section 7.4.4, "GPIB interface \(IEC/IEE bus interface\)"](#), on page 82.

## 7.4 Adjusting the interface addresses

For remote control, you can adjust the access for the individual interfaces according to your environment.



Resetting the R&S HMP manually sets the interface address to default factory state, see [Section 5.4.5, "Reset device"](#), on page 59.

In contrast, the `*RST` command and also restarting the instrument do not affect the modified interface address settings.

### 7.4.1 LAN interface

Depending on the network capabilities, the TCP/IP address information for the instrument can be obtained in different ways:

- If the network supports [DHCP](#), the DHCP server assigns the address information automatically. This mode enables you to establish a physical connection to the LAN without any additional instrument configuration. If necessary, you can also assign the address manually.
- If the network does not support DHCP, or if the instrument is set to use alternate TCP/IP configuration, you must set the addresses manually, see ["To assign the LAN interface address manually"](#) on page 79.

- **SCPI Raw Port**  
The raw TCP/IP connection uses sockets for sending raw SCPI commands to the instrument. To configure the connection, assign the port, and, if necessary, the host name of the instrument, see ["To assign the SCPI raw port address manually"](#) on page 80

### To access the LAN interface settings

It is assumed that you have connected controller PC and the instrument, see See [Section 3.1.8, "Connecting to LAN"](#), on page 24.

1. **NOTICE!** Risk of network failure. Connecting to the network can cause network failure. Errors can affect the entire network.

Consult your network administrator before performing the following tasks:

- Connecting the instrument to the network
- Configuring the network
- Changing IP addresses

2. Access:
  - a) Press the [Menu] key.
  - b) Select "Interface" with the [rotary knob].
  - c) Press the [rotary knob] to open the interface dialog.
  - d) Select "Select Interface".
  - e) Select "LAN".
  - f) Return with the [left] arrow key.



With DHCP, the IP address settings are read only (default setting). To adjust the LAN interface addresses manually, you must enable edit mode, i.e. turn off "DHCP".

### To enable edit mode

Adjusting the interface addresses manually requires that first you deactivate DHCP.

1. Access: see ["To access the LAN interface settings"](#) on page 79.
2. In the "Interface" dialog, select "Settings".  
The "Interface Settings HO732" dialog opens.
3. Select "Port Settings /DHCP".
4. Press the [rotary knob] until "DHCP" is selected.
5. Turn the [rotary knob] to set "DHCP > OFF".
6. Return with the [left] arrow key.

### To assign the LAN interface address manually

1. Access: see ["To access the LAN interface settings"](#) on page 79.
2. Disable DHCP, see ["To enable edit mode"](#) on page 79
3. In the "Interface Settings HO732" dialog, select "IP Settings".

4. Press the [rotary knob] to access the "IP Settings" dialog.  
When DHCP is deactivated, the instrument highlights the first block of the "IP Address" string for editing.  
**Tip:** To move to the next or previous parameter setting within the dialog, use the [up] and [down] arrow keys.
5. To set the highlighted address block, turn the [rotary knob] until this block of the string is selected.
6. Press the knob to confirm the setting.  
The instrument assigns the setting and steps to the next block of the address field.
7. Proceed the same way to complete the address string.  
When completed, the instrument steps to the first address block of the next parameter.
8. Repeat the steps until you have adjusted all settings.
9. To exit the dialog, press the [left] arrow key.  
The R&S HMP returns to the "Interface Settings HO732" dialog.

#### To assign the SCPI raw port address manually

1. Access: see ["To access the LAN interface settings"](#) on page 79.
2. Disable DHCP, see ["To enable edit mode"](#) on page 79.
3. In the "Interface Settings HO732" dialog, select "Port Settings /DHCP".
4. Press the [rotary knob] to access the "Port Settings /DHCP" dialog.  
When DHCP is deactivated, the instrument highlights address field of the "IP Port" for editing.  
**Tip:** To move to the next or previous parameter setting within the dialog, use the [up] and [down] arrow keys.
5. Set the port address, e.g. for the "IP Port", by turning the [rotary knob].
6. Press the knob to confirm the setting.  
The instrument assigns the setting and steps to the "HTTP Port".
7. Set the port address accordingly.
8. To exit the dialog, press the [left] arrow key.  
The R&S HMP returns to the "Interface Settings HO732" dialog.

#### To reset the LAN interface settings to default

If you need to preset the LAN interface settings, the R&S HMP enables you, to reset all LAN settings in one step:

1. Access: see ["To access the LAN interface settings"](#) on page 79.
2. In the "Interface" dialog, select "Settings".

3. In the "Interface Settings HO732" dialog, select "Load Defaults".
4. Press the [rotary knob] to start the reset process.  
The R&S HMP displays a message when the default settings are loaded.  
The "Load Defaults" resets all modified address strings and activates DHCP.
5. To exit the dialog, press the [left] arrow key.  
The R&S HMP returns to the "Interface Settings HO732" dialog.

## 7.4.2 USB interface

Option: R&S HO732, R&S HO720

### To activate the USB interface for remote control

It is assumed that you have connected the controller PC and the instrument over USB, see "[To establish a USB remote control connection](#)" on page 77.

1. Access:
  - a) Press the [Menu] key.
  - b) Select "Interface" with the [rotary knob].
  - c) Press the [rotary knob] to open the interface dialog.
  - d) Select "Select Interface".
  - e) Select "USB".
  - f) Return with the [left] arrow key.
2. In the "Interface" dialog, select "Settings".  
The "USB Class" dialog opens.
3. Select the USB class protocol, e.g. "CDC".  
**Note:** If you use the virtual COM port, you have to install the "HO720 / HO730 Virtual COM Port" driver, available for download on the product page at [www.rohde-schwarz.com/driver/hmp](http://www.rohde-schwarz.com/driver/hmp). Activate the virtual COM port (VCP) in the PC device explorer.
4. Return with the [left] arrow key.  
The USB interface does not need any further configuration. If necessary, you can adjust the USB resource string using VISA.

## 7.4.3 RS-232 interface

Option: R&S HO720 dual RS232 / USB interface

You can choose the menu item "Handshake" in the "Interface" settings. You can choose "NONE" or "CTS/RTS". "CTS/RTS" activates the interface handshake.

Consider to set the same settings also in the application program.



Using the RS-232 interface, we recommend that you activate handshake communication to avoid synchronization problems and delays.

#### To configure the RS-232 interface

It is assumed that you have connected the controller PC and the instrument over RS-232, see ["To establish an RS-232 remote control connection"](#) on page 77.

1. Press the [Menu] key.
2. Select "Interface" with the [rotary knob].
3. Press the knob to open the interface dialog.
4. Select "RS-232".
5. Return with the [left] arrow key.
6. Select "Settings" to access the parameters for configuring the interface.
7. In the "Interface Settings HO720" dialog, set e.g.:
  - a) "Baud rate": "9600"
  - b) "Stop Bits": "1"
  - c) "Parity": "None"
  - d) "Handshake": "On"

In handshake mode, the instrument activates the "CTS" and "RTS" control signals.

The settings of the RS-232 must match to the corresponding PC COM port.

### 7.4.4 GPIB interface (IEC/IEE bus interface)

Option: R&S HO740 GPIB Interface IEEE-488

The controller addresses the instrument within the GPIB bus channel, providing addresses from 0 to 30. The R&S HMP has the factory-set address 20, but you can adjust it manually according to your network environment.

#### To assign the GPIB bus address manually

It is assumed that you have connected the controller PC and the instrument over GPIB, see ["To establish a GPIB remote control connection"](#) on page 78.

1. Press the [Menu] key.
2. Select "Interface" with the [rotary knob].
3. Press the knob to open the interface dialog.
4. Select "Select Interface".
5. Select "GPIB".
6. Return with the [left] arrow key.
7. Select "Settings" to access the parameters for configuring the interface.

8. In the "Interface Settings HO740" dialog, set the "GPIB Address".
9. Press the knob to confirm the setting.  
The R&S HMP changes the GPIB address accordingly.
10. To exit the dialog, press the [left] arrow key.  
The R&S HMP returns to the "Interface Settings HO740" dialog.

## 7.5 Operating the instrument remotely

When you switch on the instrument, it is always in manual operation state (local state). You can operate it using the controls on the front panel. To operate the instrument from a remote location, see the following example for information on how control the instrument remotely over the Ethernet (LAN) interface using SCPI commands.

Prerequisites to proceed with the following instructions are:

- You have set up the connection between the R&S HMP and the controller, see [Section 3.1.8, "Connecting to LAN"](#), on page 24.
- The instrument and the controller are turned on and ready for operation.
- You have checked or if necessary assigned the correct interface address, see [Section 7.4.1, "LAN interface"](#), on page 78.

### To check the LAN connection

To verify that the LAN connection is established and works correctly, you can use the `ping` command.

- ▶ In the command prompt on the remote PC, enter `ping <ip_address>`

When the connection is working, the command returns the reply from the instrument.

### To control the instrument remotely

1. To switch to remote control, send any SCPI command from the controller PC to the R&S HMP.  
The instrument changes to remote control operating mode and blocks all front panel controls. The [Remote] key lights up.
2. Configure the settings.
3. To start a measurement, send the corresponding control commands.

### To return to manual control

- ▶ To return to local mode, press the [Remote] key.

## 8 Remote control commands

This section provides the description of all remote commands available for the R&S HMP series. The commands are sorted according to the menu structure of the instrument. A list of commands in alphabetical order is given in the "List of Commands" at the end of this documentation.



On the Rohde & Schwarz website <https://github.com/Rohde-Schwarz/Examples>, you can find ready-to-use programming examples also for power supplies.

### 8.1 Common commands

Common commands are described in the IEEE 488.2 (IEC 625-2) standard. These commands have the same effect and are employed in the same way on different devices. The headers of these commands consist of "\*" followed by three letters. Many common commands are related to the status reporting system.

*CLS.....	84
*ESE.....	84
*ESR?.....	85
*IDN?.....	85
*OPC.....	85
*RST.....	85
*SRE.....	85
*STB?.....	86
*TST?.....	86
*WAI.....	86
*SAV.....	86
*RCL.....	87

---

#### \*CLS

Clear status

Sets the status byte (STB), the standard event register (ESR) and the `EVENT` part of the `QUESTIONABLE` and the `OPERATION` registers to zero. The command does not alter the mask and transition parts of the registers. It clears the output buffer.

**Usage:**                      Setting only

---

#### \*ESE <Value>

Event status enable

Sets the event status enable register to the specified value. The query returns the contents of the event status enable register in decimal form.

**Parameters:**

<Value>                      Range:      0 to 255

---

**\*ESR?**

Event status read

Returns the contents of the event status register in decimal form and then sets the register to zero.

**Return values:**

<Contents>                      Range:      0 to 255

**Usage:**                      Query only

---

**\*IDN?**

Identification

Returns the instrument identification.

**Return values:**

<ID>                      "Rohde&Schwarz,<device type>,<part number>/<serial number>,<firmware version>"

**Usage:**                      Query only

---

**\*OPC**

Operation complete

Sets bit 0 in the event status register when all preceding commands have been executed. This bit can be used to initiate a service request. The query writes a "1" into the output buffer when all preceding commands have been executed, which is useful for command synchronization.

---

**\*RST**

Reset

Sets the instrument to a defined default status. The default settings are indicated in the description of commands.

**Usage:**                      Setting only

**Manual operation:**      See "[Reset Device](#)" on page 59

---

**\*SRE <Contents>**

Service request enable

Sets the service request enable register to the indicated value. This command determines under which conditions a service request is triggered.

**Parameters:**

<Contents> Contents of the service request enable register in decimal form.  
Bit 6 (MSS mask bit) is always 0.  
Range: 0 to 255

---

**\*STB?**

Status byte query

Reads the contents of the status byte in decimal form.

**Usage:** Query only

---

**\*TST?**

Self-test query

Initiates self-tests of the instrument and returns an error code.

**Return values:**

<ErrorCode> **integer > 0 (in decimal format)**  
An error occurred.  
**0**  
No errors occurred.

**Usage:** Query only

---

**\*WAI**

Wait to continue

Prevents servicing of the subsequent commands until all preceding commands have been executed and all signals have settled (see also command synchronization and [\\*OPC](#)).

**Usage:** Event

---

**\*SAV <Number>**

Save

Stores the current instrument settings under the specified number in an internal memory. The settings can be recalled using the command [\\*RCL](#) with the associated number.

**Parameters:**

<Number> Range: 0..9

**Manual operation:** See ["Store"](#) on page 47

---

**\*RCL** <Number>

Recall

Loads the instrument settings from an internal memory identified by the specified number. The instrument settings can be stored to this memory using the command **\*SAV** with the associated number.

**Parameters:**

<Number>                      Range:      0..9

**Manual operation:**    See "Recall" on page 47

## 8.2 INSTrument:SElect subsystem

The `INSTrument:SElect` subsystem contains the commands for selecting the output channels.

Each channel of the power supply is considered as separate "instrument", which is required by the SCPI standard. Therefore, the SCPI commands use the `INSTrument` node to select a channel.



You can only address the number of channels a device is equipped with, e.g. a maximum of three channels for the R&S HMP4030, or two channels for the R&S HMP2020.

**Example: Selecting a channel**

You can select a channel either with an `OUTput` parameter, or just by the channel number. This example lists all ways how you can select and query a selected channel.

```
// *****
// Select a channel
// *****
INST OUT1
// selects channel 1
INST?
// queries the channel selection
// response: "OUT1"

// *****
// Select a channel by its number
// *****
INST:NSEL 1
// selects channel number 1
INST:NSEL?
// queries number of the channel selection
// reponse: 1
```

<a href="#">INSTrument:NSElect</a> .....	88
<a href="#">INSTrument[:SElect]</a> .....	88

**INSTrument:NSElect** <Channel>

Selects a channel by number.

**Parameters:**

<Channel>            {1 | 2 | 3 | 4}

**Example:**            See [Example "Selecting a channel"](#) on page 88.

**Manual operation:**   See ["Select the channel"](#) on page 45

**INSTrument[:SElect]** <Channel>

Selects the channel.

**Parameters:**

<Channel>            OUTPut1 | OUTPut2 | OUTPut3 | OUTPut4 | OUTP1 | OUTP2 |  
OUTP3 | OUTP4 | OUT1 | OUT2 | OUT3 | OUT4

**OUTPut1 | OUTP1 | OUT1**

Channel 1 (Ch1)

**OUTPut2 | OUTP2 | OUT2**

Channel 2 (Ch2)

**OUTPut3 | OUTP3 | OUT3**

Channel 3 (Ch3), for R&S HMP2030 and R&S HMP40x0 instruments

**OUTPut4 |OUTP4 | OUT4**

Channel 4 (Ch4), for R&S HMP4040 instruments

**Example:** See [Example "Selecting a channel"](#) on page 88.

**Manual operation:** See ["Select the channel"](#) on page 45

## 8.3 SOURCE:VOLTage subsystem

The SOURCE:VOLTage subsystem contains the commands for setting the voltage of the output channels. The default unit is V.

**Example: Configuring the output voltage**

This example contains all commands to configure and query the output voltage.

```
// *****
// Set the voltage value
// *****
INST OUT1
VOLT 10
// selects a channel and sets the voltage

VOLT MAX
VOLT MIN
// sets the voltage to maximum or minimum respectively

VOLT?
// queries the output voltage of a channel
// response: "10.000"

// *****
// Query the range of the voltage values
// *****
VOLT? MIN
// response: "0.000"
VOLT? MAX
// queries the upper and lower limit of the output voltage
// response: "32.050"

// *****
// Increase or decrease the voltage stepwise
// *****
INST OUT1
VOLT:STEP 4
VOLT UP
// selects the output channel, sets the step width
// and increases the voltage in the selected channel
// by the set 4 Volts
VOLT DOWN
// decreases the voltage in the selected channel
// by the set 4 Volts
VOLT:STEP?
// queries the voltage step size
// response: "4.000"
```

<a href="#">[SOURCE:VOLTage[:LEVEL][:IMMEDIATE][:AMPLITUDE].....</a>	90
<a href="#">[SOURCE:VOLTage[:LEVEL]:STEP[:INCREMENT].....</a>	91

---

**[SOURCE:VOLTage[:LEVEL][:IMMEDIATE][:AMPLITUDE] <Voltage>**

Sets the voltage value of the selected channel.

**Parameters:**

<Voltage> MINimum | MAXimum | UP | DOWN

**<Voltage>**

Range: 0.000 to 32.050

Increment: 0.001

Default unit: V

**Example:** See [Example "Configuring the output voltage"](#) on page 90.

**Manual operation:** See ["Set the voltage"](#) on page 45

---

**[SOURce:]VOLTage[:LEVel]:STEP[:INCRement]**

Sets the voltage step size for the [VOLT UP](#) | [VOLT DOWN](#) command.

**Parameters:**

<Step> Range: 0.000 to 32.050

\*RST: 1.000

Default unit: V

**Example:** See [Example "Configuring the output voltage"](#) on page 90.

**Manual operation:** See ["Set the voltage"](#) on page 45

## 8.4 SOURce:CURRent subsystem

The SOURce:CURRent subsystem contains the commands for setting the current limit of the output channels. The default unit is A.

**Example: Configuring the current limit**

This example contains all commands to configure and query the output voltage.

```
// *****
// Set the voltage value
// *****
INST OUT1
CURR 2
// selects a channel and sets the current
CURR?
// queries the current of he selected channel
// response: 2.000

// *****
// Query the range of the current values
// *****
CURR? MIN
// reponse: 0.0005
CURR? MAX
// reponse: 5.000
// queries the upper and lower limit of the current

// *****
// Increase or decrease the current stepwise
// *****
INST OUT1
CURR:STEP 2
CURR DOWN
// selects the output channel, sets the step width
// and decreases the voltage in the selected channel
// by the set 2 Ampere
CURR UP
// increases the voltage in the selected channel
// by the set 2 Ampere
CURR:STEP?
// queries the current step size
// repsonse: 2.000
```

<a href="#">[SOURce:]CURRent[:LEVel][:IMMediate][:AMPLitude].....</a>	92
<a href="#">[SOURce:]CURRent[:LEVel]:STEP[:INCRement].....</a>	93

**[SOURce:]CURRent[:LEVel][:IMMediate][:AMPLitude] <Current>**

Sets the current value of the selected channel.

**Parameters:**

<Current>	<b>&lt;Current&gt;</b>
	Range: Depends on the instrument type, see the specifications document.
	Default unit: A

**Example:** See [Example "Configuring the current limit"](#) on page 92.

**Manual operation:** See ["Set the current limit"](#) on page 45

**[SOURce:]CURRent[:LEVel]:STEP[:INCRement] <Step>**

Sets the current step size for the [CURR UP](#) | [CURR DOWN](#) command.

**Parameters:**

<Step>                   Range:       0.005 / 0.001 to 10.0100A  
                           \*RST:        0.100 A  
                           Default unit: A

**Example:** See [Example "Configuring the current limit"](#) on page 92.

**Manual operation:** See ["Set the current limit"](#) on page 45

## 8.5 APPLy subsystem

The `APPLy` subsystem provides a command that enables you to set the current and voltage of a channel in one step.



The combined voltage and current setting command takes approximately 100 ms, i.e. longer than the setting of a single value.

[APPLy](#)..... 93

**APPLy <Voltage>, <Current>**

Sets the voltage and current value of the selected channel.

**Parameters:**

<Voltage>               {<Voltage> | DEF | MIN | MAX}  
                           Range:       0.000 to 32.050  
                           \*RST:        1.000  
                           Default unit: V

<Current>               {<Current> | DEF | MIN | MAX}  
                           Range:       depends on instrument type  
                           \*RST:        1.000  
                           Default unit: A

**Example:**

```
INST OUT1
APPL 6,2
// sets the output of channel 1 to 6 V and 2 A

APPL?
// queries the voltage and current the selected channel
// response: 6.000,2.000
```

## 8.6 OUTPut subsystem

The OUTPut subsystem contains the commands for activating the output channels.

### Example: Activating the channels

You can activate a selected channel and turn on or off the outputs either individually or all outputs simultaneously. This example lists all ways how you can activate and query the outputs.

```
// *****
// Activate a channel
// *****
INST OUT1
OUTP:SEL 1
// activates the selected channel

OUTP 1
// activates channel 1 and its output

OUTP?
// queries the output state
// response: 1

// *****
// Turn on all selected channels simultaneously
// *****
INST:OUT1
VOLT 12
CURR 0.1
OUTP:SEL 1

INST:OUT2
VOLT 12
CURR 0.2
OUTP:SEL 1
// selects channels 1 and 2
// sets the voltage and current values for both channels
// activates both channels

OUTP:GEN 1
// turns on the output of both channels
```

OUTPut:GENeral.....	94
OUTPut:SElect.....	95
OUTPut[:STATe].....	95

---

### OUTPut:GENeral <State>

Turns on all selected channels simultaneously.

**Parameters:**

<State> {OFF | ON | 0 | 1}  
\*RST: 0

**Example:** See [Example "Activating the channels"](#) on page 94.

**Usage:** Setting only

---

**OUTPut:SElect** <State>

Activates the selected channel.

**Parameters:**

<State> {OFF | ON | 0 | 1}  
\*RST: 0

**Example:** See [Example "Activating the channels"](#) on page 94.

**Usage:** Setting only

---

**OUTPut[:STATe]** <State>

Activates the selected channel and turns on the output.

**Parameters:**

<State> {OFF | ON | 0 | 1}  
\*RST: 0

**Example:** See [Example "Activating the channels"](#) on page 94.

**Manual operation:** See ["Activating the channel output"](#) on page 45

## 8.7 FUSE subsystem

The FUSE subsystem contains the commands for activating fuses and setting fuse parameters of the output channels.



The delay function of the fuses takes effect when the corresponding channel is activated (Output On).

**Example: Configuring fuses**

This example contains all commands to configure and query the fuse states and settings.

```
// *****
// Activate a fuse
// *****
INST OUT1
FUSE 1
// selects a channel and activates the fuse
FUSE?
// queries the state of the fuse in the selected channel
// response: 1

// *****
// Set a delay time for the fuse. The delay time
// takes effect when the channel output is turned on.
// *****
FUSE:DEL 50
// sets 50 ms delay for the fuse and
// turns on the output of the channel

FUSE:DEL?
// queries the currently set delay time of the fuse
// in the selected channel
// response: 50

FUSE:DEL MAX
FUSE:DEL MIN
// sets the delay time to maximum, minimum respectively

// *****
// Query the range of the fuse delay time
// *****
FUSE:DEL? MIN
// response: 0
FUSE:DEL? MAX
// queries the upper and lower limit of the
// fuse delay time in ms
// response: 250

// *****
// Link the electronic fuses of the channels logically
// *****
INST OUT1
FUSE:LINK 2
// links the fuse of channel 1 with channel 2

FUSE:LINK?2
// queries the combined fuses of the selected channel
```

```

// response: 1 when the fuse is linked
// response: 0 when the fuse is not linked

// *****
// Dissolve the link of the electronic fuses
// *****
INST OUT1
FUSE:LINK 2
FUSE:UNL 2
// links the fuse of channel 1 with channel2
// dissolves the fuse link

// *****
// Query a tripped fuse
// *****
INST OUT1
FUSE:TRIP?
// queries whether the fuse in channel 1 has tripped

```

<a href="#">FUSE:DElAy</a> .....	97
<a href="#">FUSE:LINK</a> .....	97
<a href="#">FUSE:TRIPped?</a> .....	98
<a href="#">FUSE:UNLink</a> .....	98
<a href="#">FUSE[:STATe]</a> .....	98

---

### **FUSE:DElAy** <Delay>

Sets a delay time for the fuse to take effect.

#### **Parameters:**

<Delay>                    {<Delay> | MIN | MAX}  
Range:                    0 to 250  
Increment:                10  
Default unit:              ms

**Example:**                See [Example "Configuring fuses"](#) on page 96.

**Manual operation:**    See ["Fuse delay"](#) on page 49

---

### **FUSE:LINK** <Channel>

Combines the fuses of several selected channels (fuse linking).

#### **Parameters:**

<Channel>                    {1 | 2 | 3 | 4}

**Example:**                See [Example "Configuring fuses"](#) on page 96.

**Manual operation:**    See ["Fuse Linking"](#) on page 48

---

**FUSE:TRIPped?**

Queries whether the fuse has tripped in the selected channel.

**Return values:**

<State>	{ON   OFF   0   1}
<b>1</b>	Fuse is tripped.
<b>0</b>	Fuse is not tripped.

**Example:** See [Example "Configuring fuses"](#) on page 96.

**Usage:** Query only

---

**FUSE:UNLink** <Channel>

Dissolves linked fuses.

**Parameters:**

<Channel> {1 | 2 | 3 | 4}

**Example:** See [Example "Configuring fuses"](#) on page 96.

**Usage:** Setting only

**Manual operation:** See ["Fuse Linking"](#) on page 48

---

**FUSE[:STATe]** <State>

Activates the fuse function in the selected channel.

**Parameters:**

<State>	{0   1   OFF   ON}
*RST:	0

**Example:** See [Example "Configuring fuses"](#) on page 96.

**Manual operation:** See ["Activate the fuse"](#) on page 45

---

## 8.8 VOLTage:PROTection subsystem

The VOLTage:PROTection subsystem contains the commands for setting the over-voltage protection parameters for the output channels. The default unit is V.

**Example: Configuring the overvoltage protection**

This example contains all commands to configure and query the protection of the output voltage.

```
// *****
// Set the overvoltage protection value
// *****
INST OUT1
VOLT:PROT 5
// selects a channel and sets the OVP
VOLT:PROT?
// queries the output overvoltage value of a channel
// response: 5

VOLT:PROT MAX
VOLT:PROT MIN
// sets the overvoltage protection to maximum,
// or minimum respectively

// *****
// Query the range of the overvoltage protection values
// *****
VOLT:PROT? MIN
// response: 0.100
VOLT:PROT? MAX
// queries the upper and lower limit
// response: 32.500

// *****
// Query a tripped overvoltage protection
// *****
INST OUT1
VOLT:PROT:TRIP?
// queries whether the OVP in channel 1 has tripped
// response: 1 OVP is tripped
// response: 0 OVP is not tripped
VOLT:PROT:CLEAr
// resets a tripped OVP in the selected channel

// *****
// Set the overvoltage protection mode
// *****
INST OUT1
VOLT:PROT:MODE PROT
// sets OVP protected mode for channel1

VOLT:PROT:MODE PROT?
// queries the OVP mode
// response: "protected"
```

VOLTage:PROTection[:LEVel].....	100
VOLTage:PROTection:CLEAr.....	100
[SOURce:]VOLTage:PROTection:MODE.....	100
VOLTage:PROTection:TRIPped?.....	100

---

### VOLTage:PROTection[:LEVel] <Voltage>

Sets the overvoltage protection value of the selected channel.

#### Parameters:

<Voltage>                    {<Voltage> | MIN | MAX}  
 Range:                    0.100 to 32.500  
 Increment:                0.100  
 Default unit:             V

**Example:**                See [Example "Configuring the overvoltage protection"](#) on page 99.

**Manual operation:**    See ["OVP Level"](#) on page 50

---

### VOLTage:PROTection:CLEAr

Resets the OVP state of the selected channel.

If an OVP event has occurred before, the reset also erases the message on the display.

**Example:**                See [Example "Configuring the overvoltage protection"](#) on page 99.

**Usage:**                    Setting only

---

### [SOURce:]VOLTage:PROTection:MODE <Mode>

Sets the OVP mode for the previously selected channel.

#### Parameters:

<Mode>                    MEASured | PROTeCted

#### **MEASured**

The OVP turns off if the measured value exceeds the threshold.

#### **PROTeCted**

If the adjusted threshold is exceeded, you cannot turn on the output of the instrument. In addition, the measured value is monitored.

**Manual operation:**    See ["OVP Mode"](#) on page 50

---

### VOLTage:PROTection:TRIPped?

Queries the OVP state of the selected channel.

<b>Return values:</b>	
<state>	{OFF   ON   0   1}
<b>Example:</b>	See <a href="#">Example "Configuring the overvoltage protection"</a> on page 99.
<b>Usage:</b>	Query only

## 8.9 MEASure subsystem

The MEASure subsystem provides commands to query the voltage and current values of a channel.

<a href="#">MEASure[:SCALar]:CURRent[:DC]?.....</a>	101
<a href="#">MEASure[:SCALar]:VOLTage[:DC].....</a>	101

---

### MEASure[:SCALar]:CURRent[:DC]?

Queries the current value of the selected channel.

<b>Return values:</b>	
<Current>	<b>&lt;numeric_value&gt;</b> Returns current reading. Default unit: A

**Example:**

```
INST OUT1
MEAS:CURR?
// response: 1.000
```

**Usage:** Query only

---

### MEASure[:SCALar]:VOLTage[:DC]

Queries the voltage value of the selected channel.

<b>Return values:</b>	
<Voltage>	<b>&lt;numeric_value&gt;</b> Returns voltage reading. Default unit: V

**Example:**

```
INST OUT1
MEAS:VOLT?
// response: 1.000
```

## 8.10 ARbitrary subsystem

The ARbitrary subsystem contains the commands for configuring an arbitrary sequence for the output channels.

**Example: Configuring an arbitrary sequence**

This programming example generates an arbitrary sequence for a selected channel. The sequence starts at 1 V and 1 A for 1 sec, and both values are incremented each second by 1. The generated arbitrary waveform is transferred to CH1. When activated, the R&S HMP provides the arbitrary waveform at the output of the selected channel, and repeats it 10 times.

```
// *****
// Define and start the arbitrary sequence
// *****
INST OUT1
ARB:DATA 1,1,1,2,2,1,3,3,1
// selects channel1
// defines the sequence, i.e. starting at 1V, 1A for 1sec,
// and increments the voltage and current each second by 1
ARB:REP 10
// sets the repetition rate
// ARB:REP? queries the set number of repetitions
ARB:TRAN 1
// transfers the arbitrary points to channel1
ARB:STAR 1
// starts the sequence
// ARB:STOP 1 stops the sequence in the selected channel
OUTP ON
// turns on the output

INST OUT1
ARB:CLEAR 1
// deletes the arbitrary waveform data of the selected channel

// *****
// Save and recall an arbitrary sequence
// *****
ARB:SAVE 1
// saves the sequence into the internal memory
ARB:REST
// loads a previously saved sequence from the internal memory
```

ARbitrary:Clear.....	102
ARbitrary:DATA.....	103
ARbitrary:REPetitions?.....	103
ARbitrary:REStore.....	103
ARbitrary:SAVE.....	104
ARbitrary:START.....	104
ARbitrary:STOP.....	104
ARbitrary:TRANsfer.....	104

**ARbitrary:Clear <Channel>**

Deletes the arbitrary waveform data of the selected channel.

**Parameters:**

&lt;Channel&gt; 1 | 2 | 3 | 4

**Example:**See [Example "Configuring an arbitrary sequence"](#) on page 102.**Usage:**

Setting only

**Manual operation:**See ["Clear Waveform"](#) on page 55**ARbitrary:DATA** <Data>

Defines the arbitrary voltage, current and time value points for the selected channel.

The dwell time between two arbitrary points is specified from 10 ms to 60 s.

**Parameters:**

&lt;Data&gt; &lt;Voltage1, Current1, Time1, Voltage2, Current2, Time2,..., Voltage128, Current128, Time128&gt;

**Voltage1 ... Voltage128**

Defines the arbitrary points of the voltage.

**Current1 ... Current128**

Defines the arbitrary points of the current.

**Time1 ... Time128**

Defines the arbitrary points of the time.

Range: Dwell time: 10 ms to 60 s; arbitrary points: 1 to 128

**Example:**See [Example "Configuring an arbitrary sequence"](#) on page 102.**Manual operation:**See ["Edit Waveform"](#) on page 54**ARbitrary:REPetitions?** <Channel>

Sets the repetition rate for the arbitrary waveform for the selected channel. If you set the rate to 0, the R&amp;S HMP repeats the waveform infinitely.

**Parameters:**

&lt;Channel&gt; 0 | 1 | 2 | ... | 255

**Example:**See [Example "Configuring an arbitrary sequence"](#) on page 102.**Usage:**

Query only

**ARbitrary:REStore** <Memory>

Loads a saved arbitrary waveform from the internal memory.

**Parameters:**

&lt;Memory&gt; 1 | 2 | 3

**Example:**See [Example "Configuring an arbitrary sequence"](#) on page 102.**Usage:**

Setting only

**Manual operation:**See ["Recall Waveform"](#) on page 55

---

**ARbitrary:SAVE** <Memory>

Saves the arbitrary waveform data in the internal memory. You can save up to three waveforms in the internal memory.

**Parameters:**

<Memory> 1 | 2 | 3

**Example:** See [Example "Configuring an arbitrary sequence"](#) on page 102.

**Usage:** Setting only

**Manual operation:** See ["Save Waveform"](#) on page 55

---

**ARbitrary:START** <Channel>

Starts the arbitrary sequence in the selected channel.

**Parameters:**

<Channel> 1 | 2 | 3 | 4

**Example:** See [Example "Configuring an arbitrary sequence"](#) on page 102.

**Usage:** Setting only

**Manual operation:** See ["Start Waveform"](#) on page 54

---

**ARbitrary:STOP** <Channel>

Stops the arbitrary sequence in the selected channel.

**Parameters:**

<Channel> 1 | 2 | 3 | 4

**Example:** See [Example "Configuring an arbitrary sequence"](#) on page 102.

**Usage:** Setting only

**Manual operation:** See ["Stop Waveform"](#) on page 54

---

**ARbitrary:TRANSfer** <Channel>

Transfers the defined arbitrary points to the selected channel.

**Parameters:**

<Channel> 1 | 2 | 3 | 4

**Example:** See [Example "Configuring an arbitrary sequence"](#) on page 102.

**Usage:** Setting only

**Manual operation:** See ["Transfer Waveform"](#) on page 54

## 8.11 SYSTem subsystem

The SYSTem subsystem contains the commands for general functions, which do not affect signal generation directly.

SYSTem:BEEPer[:IMMEDIATE].....	105
SYSTem:ERRor[:NEXT]?.....	105
SYSTem:LOCAl.....	105
SYSTem:MIX.....	106
SYSTem:REMote.....	106
SYSTem:RWLock.....	106
SYSTem:VERSion?.....	106

---

### SYSTem:BEEPer[:IMMEDIATE]

Returns a single beep immediately.

**Example:**               SYST:BEEP

**Usage:**                 Event

**Manual operation:**   See "Beeper" on page 58

---

### SYSTem:ERRor[:NEXT]?

Queries the error/event queue of the oldest item and removes it from the queue. The response is an error number and a short description of the error.

Positive error numbers are instrument-dependent. Negative error numbers are reserved by the SCPI standard. If the queue is empty the response is 0, "No error".

**Parameters:**

<error>	<b>0</b>
	No error
	<b>-100</b>
	Command error
	<b>-102</b>
	Syntax error
	<b>-350</b>
	Queue overflow

**Example:**               SYST:ERR?  
                               // queries the oldest entry in the error queue  
                               // Response: 0, "no error"

**Usage:**                 Query only

---

### SYSTem:LOCAl

Enables manual (front panel) control.

The command switches from remote control to manual control, and is required, when you have locked manual control before, see [SYSTem:RWLock](#) on page 106.

**Example:**            `SYST:LOC`  
                      `// returns from remote control to manual control`

**Usage:**            Event

---

### **SYSTem:MIX**

Enables remote control without locking manual control.

You can control the instrument in both modes simultaneously (mixed mode).

**Example:**            `SYST:MIX`

**Usage:**            Setting only

---

### **SYSTem:REMOte**

Sets the system to remote state.

The manual (front panel) control is locked.

To unlock manual control, press the Remote key.

**Example:**            `SYST:REM`

**Usage:**            Event

---

### **SYSTem:RWLock**

Locks the front panel (manual) control.

You can operate the instrument via remote control only. To return to manual control, use the command [SYSTem:LOCa1](#) on page 105. The Remote key is locked also.

**Example:**            `SYST:RWL`  
                      `// locks the control of all front panel elements,`  
                      `// including the Remote key`  
                      `SYST:LOC`  
                      `// unlocks front panel control`

**Usage:**            Event

---

### **SYSTem:VERSion?**

Queries the SCPI version the instrument's command set complies with.

**Example:**            `SYST:VERS?`  
                      `// queries the SCPI version`  
                      `// response: "1996"`

**Usage:**            Query only

---

## 8.12 STATus subsystem

The commands of the `STATus` subsystem control the status reporting structures of the `STATus:QUESTionable` registers.

See also:

- [Section 7.1.5.3, "Instrument-specific status questionable register"](#), on page 74
- [Section 7.1.5.3, "Instrument-specific status questionable register"](#), on page 74

<code>STATus:QUESTionable:ENABLE</code> .....	107
<code>STATus:QUESTionable:INSTrument:ENABLE</code> .....	107
<code>STATus:QUESTionable:INSTrument:ISUMmary&lt;ch&gt;:ENABLE</code> .....	107
<code>STATus:QUESTionable[:EVENT]?</code> .....	107
<code>STATus:QUESTionable:INSTrument[:EVENT]?</code> .....	107
<code>STATus:QUESTionable:INSTrument:ISUMmary&lt;ch&gt;[:EVENT]?</code> .....	107
<code>STATus:QUESTionable:INSTrument:ISUMmary&lt;ch&gt;:CONDition?</code> .....	107

---

### **STATus:QUESTionable:ENABLE**

### **STATus:QUESTionable:INSTrument:ENABLE**

### **STATus:QUESTionable:INSTrument:ISUMmary<ch>:ENABLE** <Enable\_Value>

Sets the enable mask that reports true conditions in the `EVENT` part in the summary bit.

If a bit in the `ENABLE` part is 1, and the corresponding `EVENT` bit is true, a positive transition occurs in the summary bit. This transition is reported to the next higher level.

The query of the `ENABLE` register returns a decimal value that corresponds to the binary weight sum.

#### **Parameters:**

<Enable\_Value>      Bit mask in decimal representation.  
                           Range:      0 to 65535

---

### **STATus:QUESTionable[:EVENT]?**

### **STATus:QUESTionable:INSTrument[:EVENT]?**

### **STATus:QUESTionable:INSTrument:ISUMmary<ch>[:EVENT]?** <Event>

Queries the `EVENT` part of the status register to check if an event has occurred since the last reading. Reading an `EVENT` register deletes its contents.

#### **Parameters:**

<Event>                Event bits in decimal representation.  
                           Range:      0 to 65535

**Usage:**                Query only

---

### **STATus:QUESTionable:INSTrument:ISUMmary<ch>:CONDition?** <Condition>

Queries the `CONDition` part of the status register to check the current instrument states. Reading the `CONDition` registers does not delete the contents.

**Return values:**

<Condition> Condition bits in decimal representation.

Range: 0 to 65535

**Usage:**

Query only

## 9 Troubleshooting

- [Displaying status information](#)..... 109
- [Problems during firmware update](#)..... 109
- [Problems with remote control over LAN](#)..... 109
- [Contacting customer support](#)..... 110

### 9.1 Displaying status information

The R&S HMP displays notifications to inform you on current settings and states. It distinguishes between status, information, and warning and error notifications.

Some information and messages are entered in the error/event queue of the status reporting system, see [Section 7.1.5, "Status reporting system"](#), on page 73.

### 9.2 Problems during firmware update

The firmware update is described in [Section 5.4.6, "Firmware update"](#), on page 59. In this section, you find useful links to solutions for potential problems that can occur during firmware update.

### 9.3 Problems with remote control over LAN

#### 9.3.1 Cannot establish a LAN connection

If you have problems to establish a LAN connection as described in [Section 3.1.8, "Connecting to LAN"](#), on page 24:

1. Check if the TCP/IP address information is valid.
2. Assign the IP address manually, e.g. if the network does not support DHCP configuration, see [Section 7.4, "Adjusting the interface addresses"](#), on page 78.

### 9.3.2 Cannot communicate over LAN

If you have problems to establish the LAN communication:

1. Refer to the application note [1SL374: How to communicate with R&S devices using VISA](#) that provides comprehensive information on configuring the interfaces, required drivers, and testing the communication.
2. If you still have problems, contact the customer support.

## 9.4 Contacting customer support

### Technical support – where and when you need it

For quick, expert help with any Rohde & Schwarz product, contact our customer support center. A team of highly qualified engineers provides support and works with you to find a solution to your query on any aspect of the operation, programming or applications of Rohde & Schwarz products.

### Contact information

Contact our customer support center at [www.rohde-schwarz.com/support](http://www.rohde-schwarz.com/support), or follow this QR code:



*Figure 9-1: QR code to the Rohde & Schwarz support page*

# 10 Transporting

## Lifting and carrying

See:

- ["Lifting and carrying the product"](#) on page 8
- [Section 3.1.1, "Lifting and carrying"](#), on page 17.

## Packing

Use the original packaging material. It consists of antistatic wrap for electrostatic protection and packing material designed for the product.

If you do not have the original packaging, use similar materials that provide the same level of protection. You can also contact your local Rohde & Schwarz service center for advice.

## Securing

When moving the R&S HMP in a vehicle or using transporting equipment, make sure that the R&S HMP is properly secured. Only use items intended for securing objects.

## Transport altitude

The maximum transport altitude without pressure compensation is specified in the specifications document.

# 11 Maintenance, storage and disposal

We advise to check the nominal data from time to time.

## 11.1 Cleaning

How to clean the product is described in "[Cleaning the product](#)" on page 11.

Do not use any liquids for cleaning. Cleaning agents, solvents, acids and bases can damage the front panel labeling, plastic parts and display.

## 11.2 Changing fuses

If the R&S HMP does not start, it is possible that a blown line fuse is the cause. Proceed as described in "[To change the fuses](#)" on page 22.

## 11.3 Storage

Protect the product against dust. Ensure that the environmental conditions, e.g. temperature range and climatic load, meet the values specified in the specifications document.

## 11.4 Disposal

Rohde & Schwarz is committed to making careful, ecologically sound use of natural resources and minimizing the environmental footprint of our products. Help us by disposing of waste in a way that causes minimum environmental impact.

### Disposing of electrical and electronic equipment

A product that is labeled as follows cannot be disposed of in normal household waste after it has come to the end of its life. Even disposal via the municipal collection points for waste electrical and electronic equipment is not permitted.



*Figure 11-1: Labeling in line with EU directive WEEE*

Rohde & Schwarz has developed a disposal concept for the eco-friendly disposal or recycling of waste material. As a manufacturer, Rohde & Schwarz completely fulfills its

obligation to take back and dispose of electrical and electronic waste. Contact your local service representative to dispose of the product.

# Annex

## A Hardware interfaces

This section covers hardware-related topics, like pin assignment of the IEC 625/IEEE 488 interface.

The remote control interfaces are described in details in [Section 7.1, "Remote control interfaces and protocols"](#), on page 68.

All other interfaces and connectors are described in [Section 3.2, "Instrument tour"](#), on page 26.

For specifications, refer to the specifications document.

### A.1 GPIB

#### Pin assignment

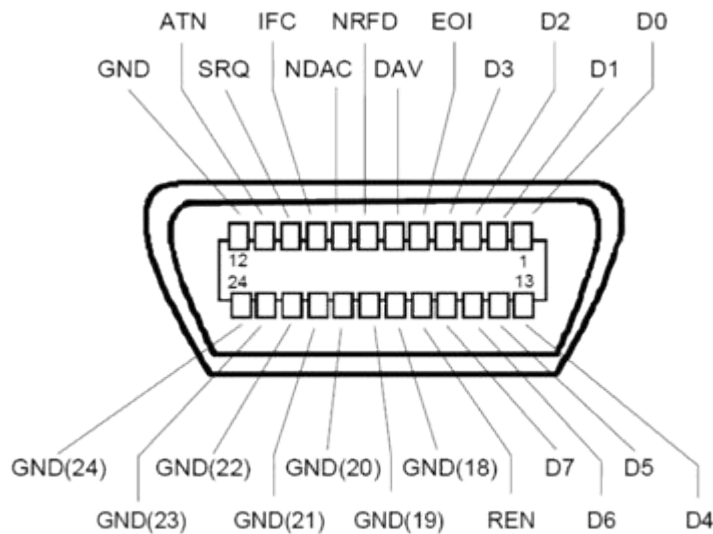

Figure A-1: Pin assignment of GPIB-bus (IEEE 488) interface

#### Bus lines

- Data bus with 8 lines D0 to D7:  
The transmission is bit-parallel and byte-serial in the ASCII/ISO code. D0 is the least significant bit, D7 the most significant bit.
- Control bus with five lines:

**IFC** (Interface Clear): active LOW resets the interfaces of the instruments connected to the default setting.

**ATN** (Attention): active LOW signals the transmission of interface messages, inactive HIGH signals the transmission of device messages.

**SRQ** (Service Request): active LOW enables the connected device to send a service request to the controller.

**REN** (Remote Enable): active LOW permits switchover to remote control.

**EOI** (End or Identify): has two functions in connection with ATN:

- ATN=HIGH active LOW marks the end of data transmission.
- ATN=LOW active LOW triggers a parallel poll.

- Handshake bus with three lines:

**DAV** (Data Valid): active LOW signals a valid data byte on the data bus.

**NRFD** (Not Ready For Data): active LOW signals that one of the connected devices is not ready for data transfer.

**NDAC** (Not Data Accepted): active LOW signals that the instrument connected is accepting the data on the data bus.

### Interface functions

Instruments which can be controlled via GPIB-bus interface can be equipped with different interface functions. [Table A-1](#) lists the interface functions for the R&S HMP.

**Table A-1: GPIB-bus interface functions**

Control character	Interface function
SH1	Handshake source function (source handshake), full capability
AH1	Handshake sink function (acceptor handshake), full capability
L4	Listener function, full capability, de-addressed by MTA.
T6	Talker function, full capability, ability to respond to serial poll, deaddressed by MLA
SR1	Service request function (Service Request), full capability
PP1	Parallel poll function, full capability
RL1	Remote/Local switch over function, full capability
DC1	Reset function (Device Clear), full capability
DT1	Trigger function (Device Trigger), full capability

## A.2 RS-232

The RS-232 interface is built with a 9-pin D-SUB connector. This bidirectional interface allows the transfer of setup parameters, data and screenshots from an external device (e.g. PC) to the power supply or vice versa.

It is possible to establish a direct connection from the PC (serial port) to the interface via 9-pin shielded cable (1:1 wired). The maximum length must not exceed 3 m.

### Pin Assignment



**Figure A-2: RS232 Pin Assignment**

- 1 = Unused
- 2 = Tx data (data from power supply to external device)
- 3 = Rx data (data from external device to power supply)
- 4 = Unused
- 5 = Ground (reference potential, connected with power supply (safety class II) and power cable to the grounding conductor)
- 6 = Unused
- 7 = CTS (Clear To Send)
- 8 = RTS (Request To Send)
- 9 = +5 V supply voltage for external devices (max. 400 mA)

The maximum voltage variation is  $\pm 12$  Volts at the Tx, Rx, RTS and CTS connections.

The RS-232 standard parameters for the interface are as follows:

- 8-N-1 (8 data bits, no parity bit, 1 stop bit)
- RTS/CTS hardware protocol: none

To set the parameters, see [Section 7.1.3, "RS-232 interface"](#), on page 72.

# Glossary: List of often used terms and abbreviations

## C

**CC:** Constant current output mode

**CDC:** Communications device class: protocol used for emulating serial ports over USB.

**Computer name:** An unambiguous indication of the instrument a LAN that uses a [DNS](#) server.

Synonym: [Hostname](#)

See [Serial number](#).

**CP:** Constant voltage output mode

## D

**DHCP:** Dynamic host configuration protocol

**DNS:** Domain name system: a service that translates domains names into IP addresses.

## G

**GPIB:** General purpose interface bus: digital interface system, used to control an instrument remotely or transfer data between two or more instruments.

**GUI:** Graphical user interface

## H

**Hostname:** [Computer name](#)

**HTTP:** Hypertext transfer protocol

## I

**IEC 625/IEEE 488:** [GPIB](#)

## O

**OSA:** Open source acknowledgment documentation embedded in the instrument firmware.

**OVP:** Overvoltage protection switches off the output when voltage exceeds the maximum value.

**P**

**PC:** Personal computer

**Product page:** A designation of the R&S HMP product page [www.rohde-schwarz.com/product/HMP.html](http://www.rohde-schwarz.com/product/HMP.html)

**R**

**Remote control:** The operation of the R&S HMP by remote control commands or programs to perform automated tests.

The instrument is connected to a system controller via LAN, GPIB or USB. The instrument is controlled directly or supported by instrument drivers.

**S**

**SCPI:** Standard commands for programmable instruments.

**Serial number:** Unique instrument identification, provided on the rear panel of the instrument and required to build the [Computer name](#).

The serial number are the last 6 digits in the string `<stock no.>-<serial number>`.

**T**

**TCP/IP:** Transmission Control Protocol / Internet Protocol. The network protocol defines the details of how data is sent and received through network adapters, hubs, switches, routers and other network communications hardware.

**U**

**URL:** Uniform resource locator: address string for unique identification of a device connected to a network.

**USB:** Universal bus interface

**USBTMC:** USB test & measurement class specification: a protocol that is built on top of USB for communication with USB devices.

**V**

**VCP:** Virtual COM port  
Synonym: [CDC](#)

**VISA:** Virtual instrument software architecture for communication over various interfaces, e.g. Ethernet, LAN or USB.

**VISA library:** Standardized I/O software interface library for communication of devices over TCP/IP protocols.

# List of commands

[SOURce:]CURRent[:LEVel]:STEP[:INCRement].....	93
[SOURce:]CURRent[:LEVel][:IMMediate][:AMPLitude].....	92
[SOURce:]VOLTage:PROTection:MODE.....	100
[SOURce:]VOLTage[:LEVel]:STEP[:INCRement].....	91
[SOURce:]VOLTage[:LEVel][:IMMediate][:AMPLitude].....	90
*CLS.....	84
*ESE.....	84
*ESR?.....	85
*IDN?.....	85
*OPC.....	85
*RCL.....	87
*RST.....	85
*SAV.....	86
*SRE.....	85
*STB?.....	86
*TST?.....	86
*WAI.....	86
APPLY.....	93
ARBitrary:Clear.....	102
ARBitrary:DATA.....	103
ARBitrary:REPetitions?.....	103
ARBitrary:REStore.....	103
ARBitrary:SAVE.....	104
ARBitrary:START.....	104
ARBitrary:STOP.....	104
ARBitrary:TRANsfer.....	104
FUSE:DELAy.....	97
FUSE:LINK.....	97
FUSE:TRIPped?.....	98
FUSE:UNLink.....	98
FUSE[:STATe].....	98
INSTRument:NSElect.....	88
INSTRument[:SElect].....	88
MEASure[:SCALar]:CURRent[:DC]?.....	101
MEASure[:SCALar]:VOLTage[:DC].....	101
OUTPut:GENeral.....	94
OUTPut:SElect.....	95
OUTPut[:STATe].....	95
STATus:QUEStionable:ENABle.....	107
STATus:QUEStionable:INSTRument:ENABle.....	107
STATus:QUEStionable:INSTRument:ISUMmary<ch>:CONDition?.....	107
STATus:QUEStionable:INSTRument:ISUMmary<ch>:ENABle.....	107
STATus:QUEStionable:INSTRument:ISUMmary<ch>[:EVENT]?.....	107
STATus:QUEStionable:INSTRument[:EVENT]?.....	107
STATus:QUEStionable[:EVENT]?.....	107
SYSTem:BEEPer[:IMMediate].....	105
SYSTem:ERRor[:NEXT]?.....	105

SYSTem:LOCal.....	105
SYSTem:MIX.....	106
SYSTem:REMOte.....	106
SYSTem:RWLock.....	106
SYSTem:VERSion?.....	106
VOLTage:PROTection:CLEar.....	100
VOLTage:PROTection:TRIPped?.....	100
VOLTage:PROTection[:LEVel].....	100

# Index

## A

AC power supply	
Rear panel .....	33
AC supply	
How to connect .....	23
Access	
Instrument .....	39
Activate output channel .....	45
Activating the fuse .....	34
Activating the output .....	35
Address	
GPIB settings .....	77
Advanced	
Instrument functions .....	47
Application cards .....	16
Application example	
Compensate voltage drops .....	61
Parallel mode .....	64
Serial mode .....	62, 63
Application examples .....	16, 61
Application notes .....	16
Apply settings commands .....	93
Arbitrary	
Setting .....	50
Arbitrary settings commands .....	101
Assigning a waveform .....	53
ATN .....	114
Attention .....	114

## B

Basic	
Instrument functions .....	45
Basic functions .....	45
Baudrate	
RS-232 .....	76
Beeper	
General instrument settings .....	58
Bench top, placing .....	18
Brochure .....	15

## C

Cable selection	
Test setup considerations .....	20
Calibration certificate .....	15
Carrying the instrument .....	17
CDC	
USB interface settings .....	76
Changing voltage or current values .....	46
Channel output	
Connector .....	30
Checking the instrument .....	17
Cleaning .....	112
Clear status	
Remote .....	84
Command sequence	
Remote .....	86
Common commands .....	84
Compensate voltage drops .....	61
Configure the GPIB interface	
Remote access .....	82

Configure the RS-232 interface	
Remote access .....	81
Configuring the USB interface	
Remote access .....	81
Connect to AC supply	
How to .....	23
Connect to ground	
How to .....	23
Connect to LAN	
How to .....	24
Connecting	
LAN .....	24
Power .....	23
Connector	
AC power supply .....	33
Channel output .....	30
GPIB .....	32
IEC/IEEE .....	32
LAN .....	32
RS-232 .....	32
Sense .....	30
USB B .....	32
Connectors	
Front panel .....	30
Rear panel .....	32
Considerations	
Setting up .....	20
Control bus .....	114
Creating a waveform .....	52
Current	
Setting .....	45
Current settings commands .....	91
Customer support .....	110

## D

Data	
Accessing .....	42
Handling .....	42
Retrieving .....	42
Data entry .....	40
Data sheet .....	15
Data valid .....	114
DAV .....	114
Default values	
Remote .....	85
DHCP	
How to: Switch off/on .....	79
DHCP state	
Port settings .....	76
Display	
Front panel .....	28
Display information .....	36
Disposal .....	112
Documentation overview .....	14
Drivers for remote control .....	16

## E

EOI .....	114
ESD	
Test setup considerations .....	20

Ethernet / USB interface		
R&S HO732	69	
Event status enable register (ESE)		
Remote	84	
Event status register (ESR)		
Remote	85	
<b>F</b>		
Firmware update		
General instrument settings	59	
Notifications	109	
Front panel		
Connectors	30	
Display	28	
HMP20x0	27	
HMP40x0	28	
Keys	29	
Overview	27	
Front panel keys		
Usage	36	
Function keys		
Overview	29	
Fuse		
Setting	47	
Fuse delay		
Setting	48	
Fuse holder		
AC power supply	33	
Fuse linking		
Setting	47	
Fuse parameters		
Setting	45	
Fuse settings commands	95	
Fuses		
How to replace the line fuse	22	
<b>G</b>		
Gateway		
IP settings	76	
General functions	55	
Beeper	58	
Firmware update	59	
Information	59	
Interface	56	
Key & display	57	
Reset device	59	
General instrument settings	55	
General system settings commands	105	
Getting started	14	
GPIB		
Characteristics	72	
How to: Adjust channel address	82	
GPIB address		
Remote access	77	
GPIB settings		
Address	77	
Ground		
How to connect	23	
<b>H</b>		
Handshake		
RS-232	76	
Hardware interfaces	114	
GPIB	114	
RS-232	115	
HO720 interface settings		
RS-232	76	
USB	76	
HO732 interface settings		
USB	76	
HO740 settings	77	
How to:		
Activate USB for remote control	81	
Adjust GPIB channel address	82	
Adjust interface address for remote access	78	
Assign IP address manually	78, 79	
Assign SCPI raw port address manually	80	
Check LAN connection	83	
Configure RS-232 interface	82	
Configure the GPIB interface	82	
Configure the RS-232 interface	81	
Configuring the USB interface	81	
Connect to AC supply	23	
Connect to ground	23	
Connecting to LAN	24	
Go to local	83	
Mount in a rack	19	
Replace the line fuse	22	
Reset LAN interface	80	
Select the supplied mains voltage	23	
Switch on/off DHCP	79	
Switch to remote control	83	
Unmount in a rack	20	
HTTP port		
Port settings	76	
<b>I</b>		
Identification		
Remote	85	
IFC	114	
Illuminated keys	27	
Information		
General instrument settings	59	
Interface settings	57	
Instrument		
Carrying	17	
Checking	17	
Lifting	17	
Operating site	17	
Setting up	18	
Unpacking	17	
Instrument control	35	
Manual operation	36	
Remote control	36	
Ways of operation	36	
Instrument functions		
Advanced	47	
Basic	45	
Instrument security procedures	15	
Instrument select commands	87	
Instrument tour	26	
Interface		
Functions (GPIB bus)	115	
General instrument settings	56	
GPIB	72	
LAN	69	
RS-232	72	
USB	71	

Interface address	
How to adjust manually .....	78
Interface clear .....	114
Interface settings	
Information .....	57
Select interface .....	56
Settings .....	56
Interfaces	
Remote control .....	68
IP address .....	70
How to: Assign address manually .....	78, 79
IP settings .....	76
IP port	
Port settings .....	76
IP settings	
Gateway .....	76
IP address .....	76
Subnet mask .....	76
<b>K</b>	
Key	
arrow .....	29
Ch x .....	29
Current .....	29
Fuse .....	29
Menu .....	29, 30
Output .....	29
Power .....	28
Recall .....	29, 30
Remote .....	29, 30
rotary knob .....	29
Store .....	29, 30
Track .....	29
Voltage .....	29
Key & display	
General instrument settings .....	57
Key features .....	13
Keys	
Front panel .....	29
<b>L</b>	
Lan	
Interface .....	69
LAN	
Connecting .....	24
Environment .....	24
How to connect .....	24
How to: Assign IP address manually .....	78, 79
How to: Assign SCPI raw port address manually .....	80
How to: Reset interface settings .....	80
How to: Switch on/off DHCP .....	79
IP address .....	70
LAN communication	
Problems .....	110
LAN connection	
Problems .....	109
Lifting and carrying .....	111
Lifting the instrument .....	17
Local mode	
How to .....	83
<b>M</b>	
Mains voltage	
How to select the supplied mains voltage .....	23
Preparing .....	21
Maintenance .....	112
Cleaning .....	112
Disposal .....	112
Fuses .....	112
Storing and packing .....	112
Manual interaction .....	36
Manual operation .....	36
Measurement controls .....	29
Measurement settings commands .....	101
Mounting in a rack .....	19
Multi-Quadrant operation .....	66
<b>N</b>	
Navigation controls .....	38
Front panel tour .....	29
NDAC .....	114
Network	
Environment .....	24
Non-operational data .....	42
NRFD .....	114
Numeric data entry .....	40
<b>O</b>	
Open source acknowledgment (OSA) .....	16
Operating mode	
Parallel .....	62
Serial .....	62
Operating site	
Choosing .....	17
Operation	
Manually .....	36
Remotely .....	40
Operation complete	
Remote .....	85
Operation status register .....	73
Operational data .....	42
Output	
Activate .....	45
Output connector	
Rear panel .....	32
Output settings commands .....	94
Overview	
Front panel .....	27
Overvoltage protection	
Setting .....	49
Overvoltage settings commands .....	98
<b>P</b>	
Packing .....	112
Parallel mode .....	62
How to set up .....	64
Parity	
RS-232 .....	76
Pin assignment	
GPIB .....	114
RS-232 .....	115
Ping .....	83
Placing, on a bench top .....	18

Port settings			
DHCP state	76		
HTTP port	76		
IP address	76		
IP port	76		
Power			
Connecting the instrument	23		
Power on			
Key	28		
Power states	25, 26		
Power supply			
Connector	33		
Fuse holder	33		
Voltage selector	33		
Preparing for use	17		
Product introduction	13		
Protective conductor terminal	30		
Protocols			
Remote control	68		
<b>Q</b>			
Questionable status register	74		
<b>R</b>			
R&SHO732			
Ethernet / USB	69		
Rack mounting	19		
How to mount the product	19		
How to unmount the product	20		
RC commands	84		
Apply voltage and current command	93		
Arbitrary settings	101		
Common	84		
Current settings	91		
Fuse settings	95		
Instrument select	87		
Measurement settings	101		
Output settings	94		
Overvoltage protection settings	98		
Status reporting	107		
System settings	105		
Voltage settings	89		
Rear panel			
AC power supply	33		
Connectors	32		
HMP20x0	30		
HMP40x0	30		
Rear panel connector block	32		
Recalling instrument settings	35		
Release notes	16		
Remote access	77		
Configure the GPIB interface	82		
Configure the RS-232 interface	81		
Configuring the USB interface	81		
GPIB address	77		
Interface settings	75		
Port settings	76		
RS-232	76		
Subnet mask setting	76		
USB	76		
Remote control	36, 40, 68		
Connecting	77		
Drivers	16		
GPIB interface	72		
How to activate	83		
How to check the LAN connection	83		
How to return to manual operation	83		
Interfaces	40, 68		
LAN interface	69		
Protocols	68		
Start	83		
Stop	83		
USB interface	71		
Remote control commands	84		
APPLY subsystem	93		
ARbitrary subsystem	101		
Common	84		
CURREnt subsystem	91		
FUSE subsystem	95		
INSTrument:SELEct subsystem	87		
MEASure subsystem	101		
OUTput subsystem	94		
STATus subsystem	107		
SYStem subsystem	105		
VOLTage subsystem	89		
VOLTage:PROTEction subsystem	98		
Remote operation			
VNC	77		
REN	114		
Replace the line fuse			
How to:	22		
Reset device			
General instrument settings	59		
Reset values			
Remote	85		
Resource string			
VISA	70		
RS-232			
Characteristics	72		
Connector	32		
How to: Configure interface settings	82		
Pin assignment	115		
RS-232 settings			
Baudrate	76		
Handshake	76		
Parity	76		
Stop bits	76		
<b>S</b>			
Safety information	7		
Safety instructions	7, 15		
Save / recall	47		
Saving instrument settings	35		
SCPI			
Apply voltage and current	93		
Arbitrary settings	101		
Common	84		
Current settings	91		
Fuse settings	95		
Instrument select	87		
Measurement settings	101		
Output settings	94		
Overvoltage protection settings	98		
Status reporting	107		
System settings	105		
Voltage settings	89		
SCPI programmers manual	14		
Securing	111		
Security procedures	15		
Select interface			
Interface settings	56		

Select the supplied mains voltage		
How to:	23	
Selecting a channel	34	
Selecting the current limit	34	
Selecting the output voltage	34	
Self-test		
Remote	86	
Sense		
Connector	30	
Serial interface		
Settings	76	
Serial mode	62	
How to set up	63	
Service manual	15	
Service request enable register (SRE)		
Remote	85	
Setting		
Arbitrary	50	
Current	45	
Fuse	47	
Fuse delay	48	
Fuse linking	47	
Fuse parameters	45	
Overvoltage protection	49	
Voltage	45	
Setting up the instrument		
Considerations	20	
Placing	18	
Setting voltage or current values	46	
Settings		
Interface	75	
Interface settings	56	
Settings controls	39	
Settings controls information	37	
Signal words	12	
Specifications	15	
SRQ	114	
Status byte		
Remote	84, 86	
Status information		
Notifications	109	
Status reporting commands	107	
Status reporting system	73	
Hierarchy of status registers	73	
Stop bits		
Baudrate	76	
Storing	112	
Subnet mask		
IP settings	76	
Switch to remote control		
How to	83	
Switching		
Off	26	
On	26	
Switching on and off	26	
Switching on or off	25	
System keys		
Overview	29	
<b>T</b>		
Test setup considerations		
Cable selection	20	
ESD	20	
Voltage in/out	20	
TMC		
USB interface settings	76	
Tracking function	45	
Transporting	111	
Lifting and carrying	111	
Securing	111	
Troubleshooting	109	
Firmware update notifications	109	
LAN communication problems	110	
LAN connection problems	109	
Status notifications	109	
Trying out	33	
Activating the fuse	34	
Activating the output	35	
Prerequisites	33	
Recalling instrument settings	35	
Saving instrument settings	35	
Selecting a channel	34	
Selecting the current limit	34	
Selecting the output voltage	34	
<b>U</b>		
Unpacking the instrument	17	
USB		
Characteristics	71	
How to: Activate for remote control	81	
USB B		
Connector	32	
USB class		
CDC	76	
TMC	76	
USB settings		
USB class	76	
User manual	14	
Using the front panel keys	36	
Utility controls	29, 30	
<b>V</b>		
VISA	69	
Resource string	70	
Voltage		
Setting	45	
Voltage drops		
Compensate	61	
Voltage in/out		
Test setup considerations	20	
Voltage selector		
AC power supply	33	
Voltage settings commands	89	
<b>W</b>		
Wait		
Remote	86	
Warning messages		
Signal words	12	
Ways of operation	36	
What's new	14	
White papers	16	