



Mess- und Prüftechnik. Die Experten.

Ihr Ansprechpartner / **dataTec AG**  
 Your Partner: E-Mail: [info@datatec.eu](mailto:info@datatec.eu)  
[datatec.eu](http://datatec.eu)



## IR lens, f=17 mm (24°) with case

### P/N: T199589

#### Copyright

© 2023, FLIR Systems, Inc.

All rights reserved worldwide. Names and marks appearing herein are either registered trademarks or trademarks of FLIR Systems and/or its subsidiaries. All other trademarks, trade names or company names referenced herein are used for identification only and are the property of their respective owners.

#### Document identity

Publ. No.: T199589  
 Commit: 73243  
 Language:  
 Modified: 2021-01-27  
 Formatted: 2023-11-01

#### Website

<http://www.flir.com>

#### Customer support

<http://support.flir.com>

#### Disclaimer

Specifications subject to change without further notice. Camera models and accessories subject to regional market considerations. License procedures may apply. Products described herein may be subject to US Export Regulations. Please refer to [exportquestions@flir.com](mailto:exportquestions@flir.com) with any questions.



Imaging and optical data	
Field of view (FOV)	24° × 18°
Minimum focus distance	0.15 m (0.49 ft.)
Minimum focus distance with MSX	0.5 m (1.64 ft.)
Focal length	17 mm (0.67 in.)
Spatial resolution (IFOV)	Dependent on the IR resolution of the camera: <ul style="list-style-type: none"> <li>• 320 × 240 pixels: 1.31 mrad/pixel</li> <li>• 464 × 348 pixels: 0.90 mrad/pixel</li> <li>• 640 × 480 pixels: 0.66 mrad/pixel</li> </ul>
Lens identification	Yes, AutoCal
F-number	1.3
Measurement	
Accuracy	±3°C (±5.4°F) or ±3% of reading, for ambient temperature 15–35°C (59–95°F) and object temperature above 0°C (32°F).
Physical data	
Weight	0.140 kg (0.31 lb.)
Size (L × D)	45.4 × 72 mm (1.79 × 2.83 in.)
Shipping information	
Packaging, type	Cardboard box
List of contents	<ul style="list-style-type: none"> <li>• Lens</li> <li>• Lens case</li> </ul>
Packaging, weight	0.410 kg (0.90 lb.)
Packaging, size	151 × 125 × 125 mm (5.9 × 4.9 × 4.9 in.)
EAN-13	4743254003125
UPC-12	845188014520
Country of origin	Sweden and/or Estonia

#### Compatible with the following products:

- 79301-0101; FLIR T530 14°
- 79302-0101; FLIR T530 24°
- 79304-0101; FLIR T530 24° + 14°
- 79306-0101; FLIR T530 24° + 14° & 42°
- 79305-0101; FLIR T530 24° + 42°

# IR lens, f=17 mm (24°) with case

P/N: T199589

© 2023, FLIR Systems, Inc.

#T199589; r. 73243;

- 79303-0101; FLIR T530 42°
- 79307-0101; FLIR T530 42° + 14°
- 79308-0101; FLIR T530 Dual FOV 14° + 24°
- 79301-0201; FLIR T540 14°
- 79302-0201; FLIR T540 24°
- 79304-0201; FLIR T540 24° + 14°
- 79306-0201; FLIR T540 24° + 14° & 42°
- 79305-0201; FLIR T540 24° + 42°
- 79303-0201; FLIR T540 42°
- 79307-0201; FLIR T540 42° + 14°
- 79308-0201; FLIR T540 Dual FOV 14° + 24°
- 89001-0101; FLIR T560 14°
- 89002-0101; FLIR T560 24°
- 89004-0101; FLIR T560 24° + 14°
- 89006-0101; FLIR T560 24° + 14° & 42°
- 89005-0101; FLIR T560 24° + 42°
- 89003-0101; FLIR T560 42°
- 89007-0101; FLIR T560 42° + 14°
- 89009-0101; FLIR T560 Dual FOV 14° + 24°
- 79309-0101; FLIR T530 80°
- 79309-0201; FLIR T540 80°
- 89010-0101; FLIR T560 80°
- 82501-0201; FLIR T840 14°
- 82502-0201; FLIR T840 24°
- 82504-0201; FLIR T840 24° + 14°
- 82506-0201; FLIR T840 24° + 14° & 42°
- 82509-0201; FLIR T840 24° + 14° & 6°
- 82505-0201; FLIR T840 24° + 42°
- 82508-0201; FLIR T840 24° + 6°
- 82503-0201; FLIR T840 42°
- 82507-0201; FLIR T840 42° + 14°
- 82510-0201; FLIR T840 Dual FOV 14° + 24°
- 89201-0101; FLIR T860 14°
- 89202-0101; FLIR T860 24°
- 89204-0101; FLIR T860 24° + 14°
- 89206-0101; FLIR T860 24° + 14° & 42°
- 89211-0101; FLIR T860 24° + 14° & 6°
- 89205-0101; FLIR T860 24° + 42°
- 89210-0101; FLIR T860 24° + 6°
- 89203-0101; FLIR T860 42°
- 89207-0101; FLIR T860 42° + 14°
- 89212-0101; FLIR T860 Dual FOV 14° + 24°
- 89201-0201; FLIR T865 14°
- 89202-0201; FLIR T865 24°
- 89204-0201; FLIR T865 24° + 14°
- 89206-0201; FLIR T865 24° + 14° & 42°
- 89213-0201; FLIR T865 24° + 14° & 6°
- 89205-0201; FLIR T865 24° + 42°
- 89212-0201; FLIR T865 24° + 6°
- 89203-0201; FLIR T865 42°
- 89207-0201; FLIR T865 42° + 14°
- 89214-0201; FLIR T865 Dual FOV 14° + 24°
- 82511-0201; FLIR T840 80°
- 89215-0201; FLIR T865 80°
- 78511-1101; FLIR E76 14°
- 78512-1101; FLIR E76 24°
- 78514-1101; FLIR E76 24° + 14°
- 78516-1101; FLIR E76 24° + 14° & 42°
- 78515-1101; FLIR E76 24° + 42°



Mess- und Prüftechnik. Die Experten.

Ihr Ansprechpartner / **dataTec AG**  
Your Partner: E-Mail: [info@datatec.eu](mailto:info@datatec.eu)  
[datatec.eu](http://datatec.eu)



---

## IR lens, f=17 mm (24°) with case

---

**P/N: T199589**

© 2023, FLIR Systems, Inc.

#T199589; r. 73243;

- 78513-1101; FLIR E76 42°
- 78517-1101; FLIR E76 42° + 14°
- 78518-1101; FLIR E76 Dual FOV 14° + 24°
- 78511-1301; FLIR E86 14°
- 78512-1301; FLIR E86 24°
- 78514-1301; FLIR E86 24° + 14°
- 78516-1301; FLIR E86 24° + 14° & 42°
- 78515-1301; FLIR E86 24° + 42°
- 78513-1301; FLIR E86 42°
- 78517-1301; FLIR E86 42° + 14°
- 78518-1301; FLIR E86 Dual FOV 14° + 24°
- 90201-0101; FLIR E96 14°
- 90202-0101; FLIR E96 24°
- 90204-0101; FLIR E96 24° + 14°
- 90206-0101; FLIR E96 24° + 14° & 42°
- 90205-0101; FLIR E96 24° + 42°
- 90203-0101; FLIR E96 42°
- 90207-0101; FLIR E96 42° + 14°
- 90208-0101; FLIR E96 Dual FOV 14° + 24°
- 78519-1101; FLIR E76 80°
- 78519-1301; FLIR E86 80°
- 90209-0101; FLIR E96 80°

© 2016, FLIR Systems, Inc. All rights reserved worldwide. No part of this drawing may be reproduced, stored in a retrieval system, or transmitted in any form, or by any means, electronic, mechanical, photocopying, recording, or otherwise, without written permission from FLIR Systems, Inc. Specifications subject to change without further notice. Dimensional data is based on nominal values. Products may be subject to regional market considerations. License procedures may apply. Product may be subject to US Export Regulations. Please refer to exportquestions@flir.com with any questions. Diversion contrary to US law is prohibited.



Lens IR f=10mm (42°)

Lens IR f=17mm (24°)

Lens IR f=29mm (14°)

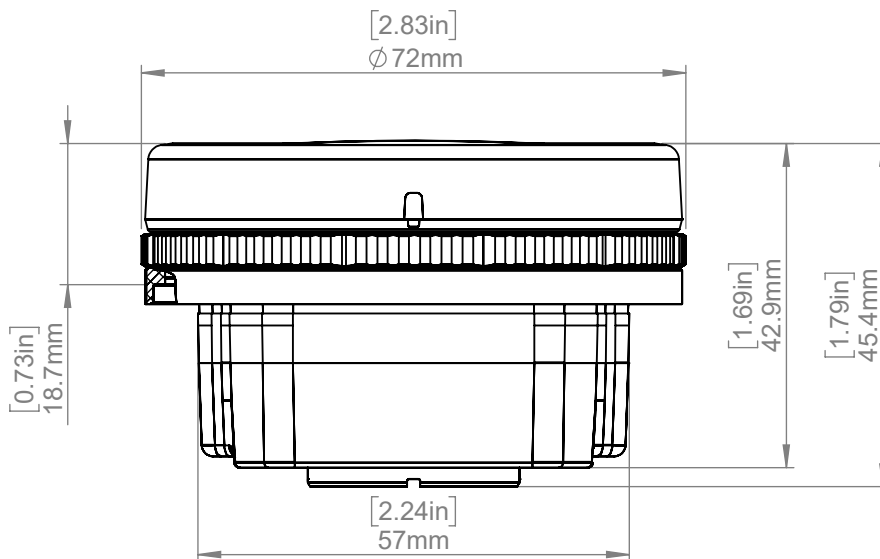
Lens IR Close-Up (2x) 



Modified 2019-09-30	Check JOHE	Drawn by R&D Instruments			
Denomination				Size A4	
Basic dimensions for lenses T199104, T199105, T199106, T199598			Scale 1:1		Sheet 1(1)
			Drawing No. T130322		Rev B