

Keysight 1147B 50 MHz Current Probe

User's Guide



Distributed by:

Sie haben Fragen oder wünschen eine Beratung? Angebotsanfrage unter **07121 / 51 50 50** oder über info@datatec.de

datatec

Notices

© Keysight Technologies, Inc. 2000- 2016, 2018, 2020

No part of this manual may be reproduced in any form or by any means (including electronic storage and retrieval or translation into a foreign language) without prior agreement and written consent from Keysight Technologies, Inc. as governed by United States and international copyright laws.

Manual Part Number

01147-97002

December 2020

Published in USA

Published by:
Keysight Technologies, Inc.
1400 Fountaingrove Parkway
Santa Rosa, CA, 95403

Warranty

The material contained in this document is provided “as is,” and is subject to being changed, without notice, in future editions. Further, to the maximum extent permitted by applicable law, Keysight disclaims all warranties, either express or implied, with regard to this manual and any information contained herein, including but not limited to the implied warranties of merchantability and fitness for a particular purpose. Keysight shall not be liable for errors or for incidental or consequential damages in connection with the furnishing, use, or performance of this document or of any information contained herein. Should Keysight and the user have a separate written agreement with warranty terms covering the material in this document that conflict with these terms, the warranty terms in the separate agreement shall control.

Technology Licenses

The hardware and/or software described in this document are furnished under a license and may be used or copied only in accordance with the terms of such license.

Restricted Rights Legend

If software is for use in the performance of a U.S. Government prime contract or subcontract, Software is delivered and licensed as “Commercial computer software” as defined in DFAR 252.227-7014 (June 1995), or as a “commercial item” as defined in FAR

2.101(a) or as “Restricted computer software” as defined in FAR 52.227-19 (June 1987) or any equivalent agency regulation or contract clause. Use, duplication or disclosure of Software is subject to Keysight Technologies’ standard commercial license terms, and non-DOD Departments and Agencies of the U.S. Government will receive no greater than Restricted Rights as defined in FAR 52.227-19(c)(1-2) (June 1987). U.S. Government users will receive no greater than Limited Rights as defined in FAR 52.227-14 (June 1987) or DFAR 252.227-7015 (b)(2) (November 1995), as applicable in any technical data.

Safety Notices

CAUTION

A **CAUTION** notice denotes a hazard. It calls attention to an operating procedure, practice, or the like that, if not correctly performed or adhered to, could result in damage to the product or loss of important data. Do not proceed beyond a **CAUTION** notice until the indicated conditions are fully understood and met.

WARNING

A **WARNING** notice denotes a hazard. It calls attention to an operating procedure, practice, or the like that, if not correctly performed or adhered to, could result in personal injury or death. Do not proceed beyond a **WARNING** notice until the indicated conditions are fully understood and met.

Contents

Introduction	/	5
Safety	/	6
Description of Parts	/	11
Using the Probe	/	13
Performance Verification for 1147B Probe	/	17
Characteristics and Specifications	/	21
Product Markings and Labels	/	25
Service Strategy	/	26

Introduction

The 1147B is a wide-band, DC to 50 MHz, active current probe. The probe features low noise and low circuit insertion loss. The intelligent interface makes the probe ideal for use with the InfiniiVision and Infiniium products using the AutoProbe interface. This unique probe interface makes current measurements as simple as those made with the active voltage probes.

The 1147B has two operating regions that provide a wide, flat frequency response. In the DC to low frequency AC region, the probe operation is based on the negative feedback of the amplifier system that includes the thin film Hall element as a detector. In the high frequency region, the probe operates as a current transformer.

The 1147B is ideal for acquiring high transient time signals such as those found in motor controllers, in switching power supplies, and in current amplifiers driving inductive loads.

In order to use this product effectively and to ensure a long operational life, read this user's guide carefully and retain it for future reference.

Features

- Highly accurate current detection
- Split-core construction allows easy circuit connection
- Broadband frequency characteristics DC to 50 MHz
- Connects directly to InfiniiVision and Infiniium scope with 1 M Ω AutoProbe interface
- Easy to degauss and offset zero calibration
- Easy protect function at excessive input
- Carrying case

Inspection

When the unit is delivered, check and make sure that it has not been damaged in transit. If the unit is damaged, or fails to operate according to the specifications, contact your dealer or Keysight representative.

Safety

This manual provides information and warnings essential for operating this equipment in a safe manner and for maintaining it in safe operating condition. Before using this equipment, be sure to carefully read the following warnings, cautions, and notes.

NOTE

This equipment is designed according to IEC 61010-1 Safety Standards, and has been tested for safety prior to shipment. Incorrect measurement procedures could result in injury or death, as well as damage to the equipment. Please read this manual carefully and be sure that you understand its contents before using the equipment. The manufacturer disclaims all responsibility for any accident or injury except that resulting due to defect in its product.

WARNING

Only trained service personnel who are aware of the hazard involved (for example, fire and electric shock) should perform maintenance on the instrument. When maintenance can be performed without power applied, the power cord must be disconnected from the instrument.

WARNING

To avoid short circuits and accidents that could result in injury or death, use the 1147B only with power lines carrying 300V or less.

WARNING

When conductors being measured carry in excess of the safe voltage level (SELV-E) and not more than 300V, to prevent short circuits and electric shock while the core section is open, make sure that conductors to be measured are insulated with material conforming to (1) Overvoltage Category I, (2) Basic Insulation Requirements for Working Voltages of 300 V, and (3) Pollution Degree 2. Never use this sensor on bare conductors, the core and shield case are not insulated. If a bare conductor is inevitable to be measured, make sure that the power to the wire must be turned off, when opening the jaws of the probe to insert or remove the bare wire so that 300V Mains Isolated is always satisfied.

WARNING

Avoid damaging the cable insulation surfaces while taking measurements.

WARNING

This instrument is only made for use with the Infiniium. Do not plug the probe into any interface other than the AutoProbe interface, of which Infiniium has a protective earthing with double-insulation construction.

WARNING

Take the following precautions to ensure that the Infiniium does not form a bridge between the probe and any hazardous live part:

- Isolate the AutoProbe interface to which the probe is connected from other AutoProbe interfaces using basic insulation conforming to the overvoltage category, working voltage, and pollution degree requirements of the circuit being tested.
- If basic insulation requirements cannot be met between the AutoProbe interface to which this unit is connected and other AutoProbe interfaces of the measuring instrument, make sure that the voltage input to the AutoProbe interfaces does not exceed the safe voltage level (SELV-E).
- Read and observe all warnings and precautions relating to electrical safety for the Infiniium.

WARNING

Refer to the following standards regarding the meanings of underlined terms: IEC61010-1, IEC61010-2-031, and IEC61010-2-032.

WARNING

To prevent electric shock, do not allow the unit to become wet and do not use the unit when your hands are wet.

WARNING

The maximum continuous input range is based on heat that is internally generated during measurement. Never input current in excess of this level. Exceeding the rated level may result in damage to the probe.

WARNING

The maximum continuous input range varies according to the frequency of the current being measured. See [Figure 10 on page 24](#) in “Characteristics and Specifications”.

WARNING

If excess current is input, generated heat activates a built-in safety function that blocks normal output. If this happens, remove the input immediately (unclamp the sensor from the conductor being measured or reduce the input current to zero). Wait until the sensor has had sufficient time to cool before resuming operation.

WARNING

Even if the input current does not exceed the rated continuous maximum, continuous input for an extended period of time may result in activation of the safety circuit to prevent damage resulting from heating of the sensor.

WARNING

At high ambient temperatures, the built-in safety circuit may activate at current input levels below the rated continuous maximum.

WARNING

Continuous input of current exceeding the rated maximum or repeated activation of the safety function may result in damage to the unit.

WARNING

Do NOT measure current such that the total probe current consumption exceeds the allowable AutoProbe interface current consumption. The excess current consumption causes a temporary shutdown of the Infiniium power supply for safety. Quit the measurement and cycle the power of the Infiniium, if the shutdown occurs. The typical probe current consumption from the AutoProbe interface is shown in [Figure 1 on page 9](#).

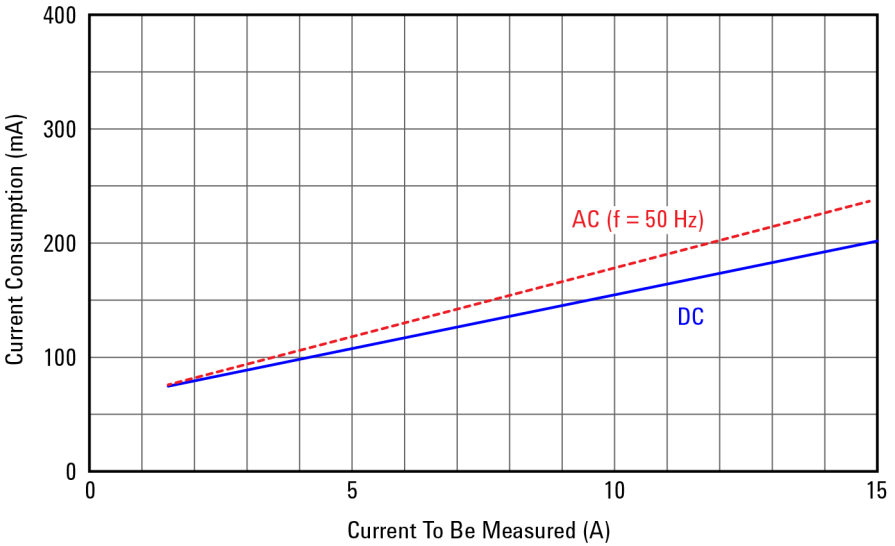

Figure 1 Typical Probe Consumption

CAUTION

Do not subject the unit to vibrations or shocks during transport or handling. Be especially careful to avoid dropping the unit.

CAUTION

Do not store the unit where it will be exposed to direct sunlight, high temperature, high humidity, or condensation. If exposed to such conditions, the unit may be damaged, the insulation may deteriorate, and the unit may no longer satisfy its specifications.

CAUTION

Before using the unit, inspect it and check the operation to make sure that the unit was not damaged due to poor storage or transport conditions. If damage is found, contact your dealer or Keysight representative.

CAUTION

This unit is not constructed to be waterproof or dustproof, so do not use it in a very dusty environment or in one where it will get wet.

CAUTION

The sensor head is a precision assembly including a molded component, a ferrite core, and a Hall effect element. It may be damaged if subjected to sudden changes in ambient temperature, or mechanical strain or shock, and therefore great care should be exercised in handling it.

CAUTION

The matching surfaces of the sensor head are precision ground, and should be treated with care. If these surfaces are scratched, performance may be impaired.

CAUTION

Do not bend or pull the sensor cable and power supply cable in order to avoid damaging the sensor cables.

CAUTION

Gently wipe dirt from the surface of the unit with a soft cloth moistened with a small amount of water or mild detergent. Do not try to clean the unit using cleaners containing organic solvents such as benzine, alcohol, acetone, ether, ketones, thinners, or gasoline. They may cause discoloration or damage.

CAUTION

To avoid scratching the surfaces of the Hall effect elements, keep the core section of the sensor closed, except when clamping it around the conductor to be measured.

NOTE

Accurate measurement may be impossible in locations subject to strong external magnetic fields, such as transformers and high-current conductors, or in locations subject to strong external electric fields, such as radio transmission equipment.

Description of Parts

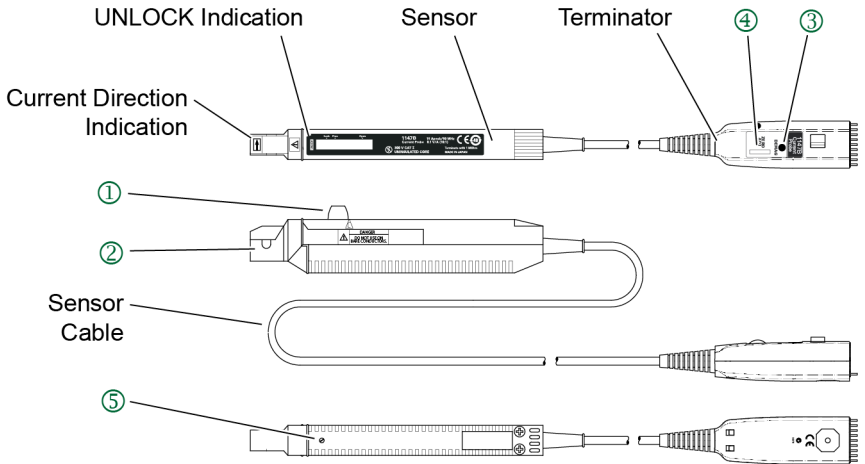

Figure 2 Probe Parts Identification

① Opening Lever

Operating lever for opening the sensor head. Always use this lever to open the sensor head.

② Sensor Head

This clamps the conductor being measured, and carries out the actual current measurement. It is a precision assembly including a molded component, a ferrite core, and a Hall effect element. It may be damaged if subjected to sudden changes in ambient temperature, or mechanical strain or shock. Care should be exercised when handling the sensor head.

③ Demagnetizing Switch (DEMAG)

This demagnetizes the core if it has been magnetized by switching the power on and off, or by an excessive input. Always carry out demagnetizing before measurement. The demagnetizing process takes about one second. During demagnetizing, a demagnetizing waveform is output. Refer to “Demagnetization and Zero Adjustment” on page 16.

④ Zero Adjustment Dial (ZERO ADJ)

Use the zero adjustment dial to correct for the effect of a voltage offset or temperature drift on the unit. The probe should be always be zeroed after demagnetization. Refer to “Demagnetization and Zero Adjustment” on page 16.

⑤ Coarse Adjustment Trimmer

This adjustment should only be carried out if the probe offset is outside the range of the zero adjustment dial.

NOTE

The output of this unit is terminated internally. The high-impedance such as $1\text{ M}\Omega$ input impedance will be automatically selected on the Infiniium, as the Terminator is plugged into the AutoProbe interface. With an input impedance of $50\ \Omega$, accurate measurement is not possible.

NOTE

The probe output sensitivity 0.1 V/A will be automatically selected, as the Terminator is plugged into the AutoProbe interface. With an different output sensitivity, accurate measurement is not possible.

Using the Probe

WARNING

Ensure all safety warnings and precautions are followed. Before using the probe, study the warning and precautions in "Safety" on page 6.

NOTE

This probe is NOT compatible with 50 Ω only Infiniium oscilloscopes (for example, the DSO80000 or 90000 series oscilloscopes). The input coupling is automatically selected to DC, as the Terminator is plugged into the AutoProbe interface.

NOTE

Immediately after powering on, this probe may be subject to an appreciable offset drift due to the effect of self-heating. To counteract this, allow the probe to warm up for about 30 minutes before carrying out measurement.

Making Measurements

- 1 Power on the oscilloscope.
- 2 Connect the probe terminator to one of the scope channels.

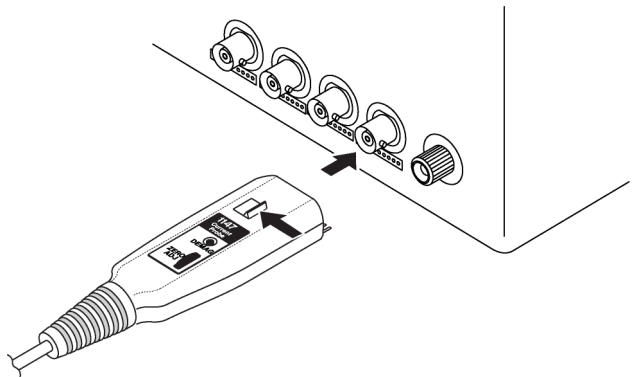

Figure 3 Connecting the Probe to the Oscilloscope

NOTE

When the probe is connected to a scope channel, the AutoProbe interface recognizes the probe as an 1147B and automatically sets the channel to 1 M Ω input resistance with DC input coupling.

- 3 Perform the steps in “Demagnetization and Zero Adjustment” on page 16.
- 4 Using the probe’s opening lever, clamp the sensor head around the conductor to be measured as shown in Figure 4 on page 14.

CAUTION

Always use the opening lever when opening the probe’s sensor head. If an upper core is forced to open when the sensor head is locked, the open-close mechanism can be damaged.

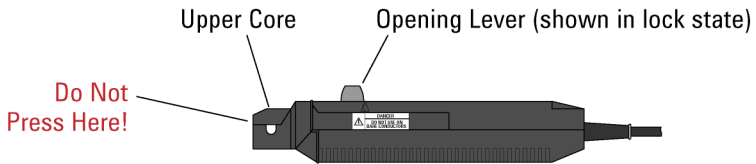

Figure 4 Use the Opening Lever

- 5 To obtain the best accuracy, ensure that:
 - The current direction indicator on the sensor aligns with actual current direction in the conductor.
 - The sensor opening lever is in the Locked position
 - The cable is centered in the sensor head.
- 6 At high frequencies, common mode noise may affect measurements taken on the high voltage side of circuits. If this occurs, reduce the frequency range of the measuring instrument or clamp onto the low-voltage side of the circuit (as shown in Figure 5 on page 15), as appropriate.

NOTE

When performing continuous measurements, it is necessary to be aware that the zero offset voltage will drift if the ambient temperature changes.

NOTE

Under certain circumstances, oscillation may occur if the probe is connected to the AutoProbe interface while the Infiniium is on. This does not indicate a malfunction. Oscillation can be stopped and operation restored to normal by opening and closing the sensor head.

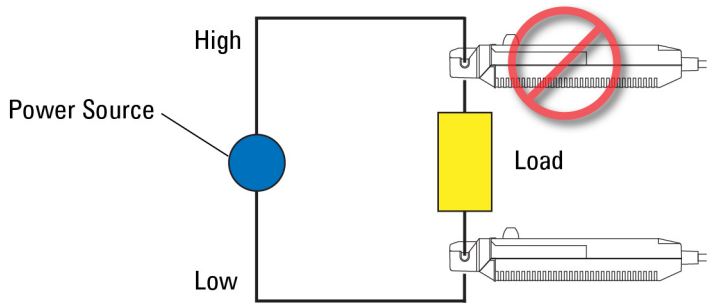

Figure 5 Clamp Onto the Low-Voltage Side of Circuit

NOTE

At some frequencies, some sound may be produced by resonance, this has no effect on measurements.

NOTE

Measurement accuracy is affected by the position of the conductor being measured within the clamp aperture. The conductor should be in the center of the clamp aperture.

NOTE

Before making a measurement, press the opening lever until the "UNLOCK" indication disappears and check that the sensor head is properly closed. If the sensor head is not properly closed, accurate measurement will not be possible.

NOTE

Accurate measurement may be impossible in locations subject to strong external magnetic fields, such as transformers and high-current conductors, or in locations subject to strong external electric fields, such as radio transmission equipment.

Demagnetization and Zero Adjustment

- 1 Allow both the Infiniium oscilloscope and the probe to warm up for at least 30 minutes before making these adjustments.
- 2 Ensure that the channel offset is set to 0V on the oscilloscope channel to which the probe is connected.
- 3 Ensure that the probe sensor is NOT clamped around any conductors.
- 4 Slide the probe sensor Opening Lever into the Locked position. Refer to [Figure 4 on page 14](#) for the location of the lever.
- 5 Press the **DEMAG** button on the terminator. A demagnetization waveform will be displayed for a short time on the channel to which the probe is connected. Wait until this waveform is no longer displayed.
- 6 When the demagnetization waveform is no longer displayed, adjust the **ZERO ADJ** control on the probe terminator to move the trace for the channel to which the probe is connected as close as possible to the 0V position. If the **ZERO ADJ** control cannot center the trace adequately, then do the following:
 - a Move the **ZERO ADJ** control to a midrange position.
 - b Carefully adjust the Coarse Adjustment Trimmer on the probe sensor to move the trace on the channel to which the probe is connected as close as possible to the 0V position.
 - c Adjust the **ZERO ADJ** control on the probe terminator to move the trace for the channel to which the probe is connected as close as possible to the 0V position.

Performance Verification for 1147B Probe

Use the following procedure to test the warranted Accuracy specifications (as listed on [page 21](#)) for the 1147B probe. The recommended test interval to warrant performance of this probe is once a year. However, you can also test the probe's performance as and when required using the recommended test equipment and by following the procedure documented in this chapter.

Table 1 Required Test Equipment

Description	Minimum Requirements	Recommended Test Equipment
Oscilloscope	Bandwidth ≥ 250 MHz Amplitude accuracy: $\leq 0.4\%$	Infiniium oscilloscope with 1 M Ω input
Two Digital Multimeters	-	Keysight U1251B Handheld Digital Multimeter or equivalent DVM/DMM
AC Current Generator	AC 10 A _{rms} , 50 Hz, sine wave Amplitude accuracy: $\leq 0.3\%$	Keysight AC6800 or Wavetek 9100
Probe Adapter	-	Keysight N1022B Probe Adapter
Power Supply	-	Keysight 1143A Probe Offset Control and Power Module
Test Cables (with banana jacks)	-	-
BNC Cable	-	-
BNC (F) to Banana Adapter	-	-
NMD 3.5mm (M) to 3.5mm (F) adapter	-	-
3.5mm (M) to BNC (F) adapter	-	-

Procedure

- 1 To provide power to the probe, connect the power cord of the N1022B probe adapter to the Power connector on the front panel of the 1143A power module. Then connect the 1147B probe's output to the N1022B probe adapter's input.

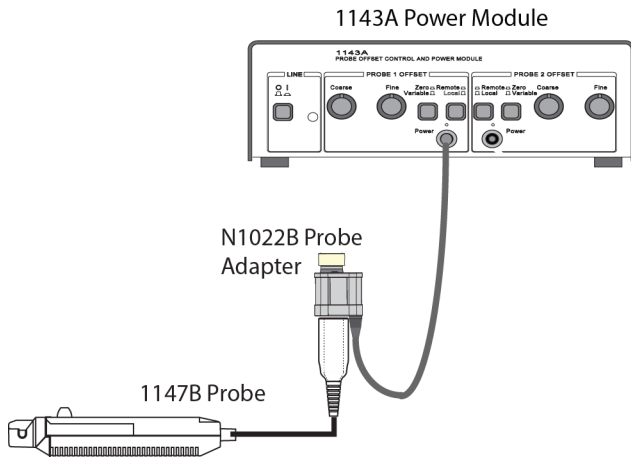

Figure 6 Providing power to the 1147B probe

- 2 Turn on the equipment.
- 3 Wait for 20 minutes to allow the probe to warm up.
- 4 Connect the test setup as shown in [Figure 7 on page 19](#) as per the following substeps.
 - a Clamp the 1147B probe around the test cable <1> and lock the sensor head of the probe.
 - b Press the **DEMAG** button on the probe.
 - c Set the digital multimeter (DMM <1>) to A_{rms} mode.
 - d Connect the test cable <1> to the positive terminal of the AC current generator's OUTPUT terminal block and to the current input of the DMM <1>.
 - e Connect the test cable <2> to the negative terminal of the AC current generator's OUTPUT terminal block and to negative input of the DMM <1>.
 - f Using the DMM <1>, set the output current of AC current generator to $6A_{rms}$.

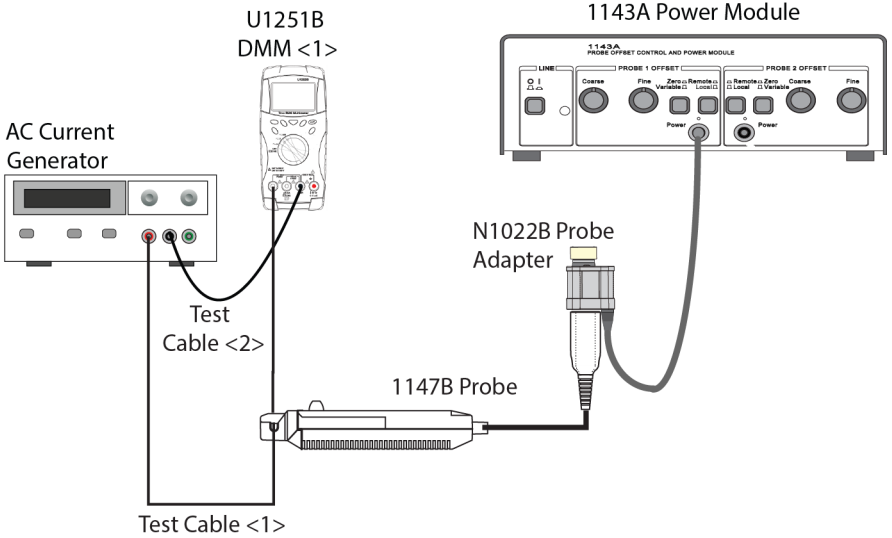

Figure 7 Setting up AC Current Generator

- 5 Set the DMM <2> to V_{rms} mode.
- 6 As displayed in [Figure 8 on page 20](#), connect a BNC cable to the:
 - a N1022B adapter's output using the NMD 3.5mm (M) to 3.5mm (F) adapter and 3.5mm (M) to BNC (F) adapter.
 - b DMM <2> using a BNC (F)-to-banana adapter.

This completes the test setup.

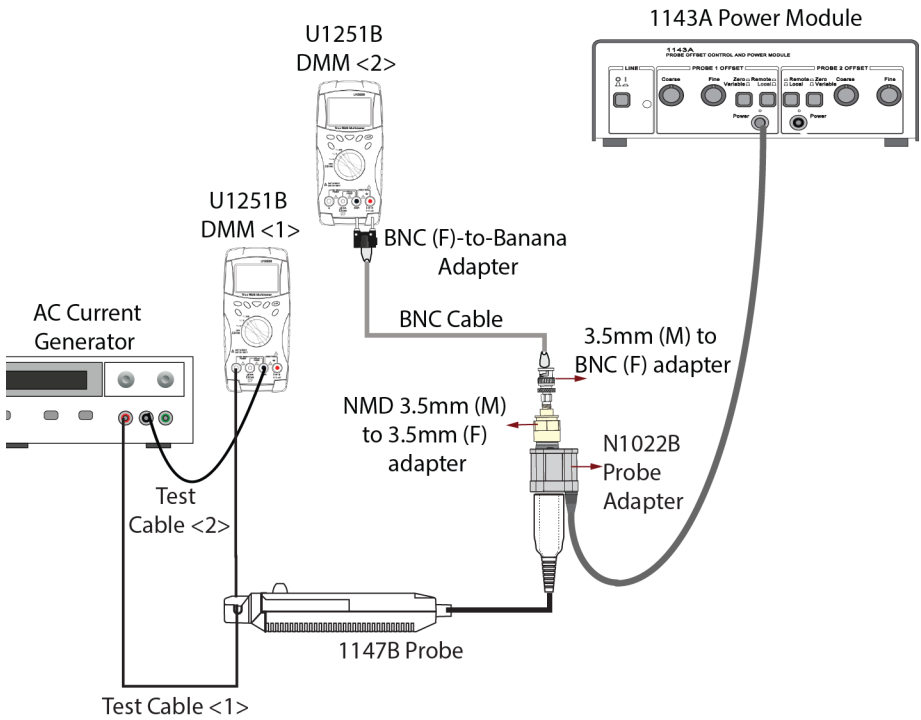

Figure 8 Complete Test Setup

- 7 Measure the current and record V_{rms} output of the probe as displayed on the DMM <2>.
- 8 Calculate gain as follows:

$$\text{Gain} = V_{rms} / A_{rms}$$

Gain should be between 0.99 and 1.01 (+/-1% gain accuracy).

- 9 Remove the test cable and AC current generator from the 1147B probe.

Characteristics and Specifications

Table 2 Measurement Characteristics

Item	Characteristic ^a
Probe Bandwidth	DC to 50 MHz (-3 dB)
Accuracy (Probe Only) ^b	±1% of reading ±1mV (DC or 45 Hz to 66 Hz)
Risetime ^c	≤ 7ns
Maximum current	<p>With InfiniiVision 3000X/T, 5000/6000/7000 Series: 15A peak(DC+AC peak), 15A_{DC}, 10A_{rms} continuous Max. peak: 30A peak non-continuous (when upto two probes are used) 30A peak(DC+AC peak), 30 A_{DC}, 24A_{rms} continuous Max. peak: 32A peak non-continuous (when one probe is used)</p> <p>With Infiniium or InfiniiVision 4000X, 6000X Series: 15A peak, 15A_{DC}, 10A_{rms} continuous, 30A peak non-continuous (per each channel) (Refer to frequency derating curve, Figure 10 on page 24)</p> <p>With MXR/EXR oscilloscope main channels (channel 1 to 4) DC: 30Adc, Continuous AC: 30Arms, 42Apeak Non-continuous AC: 50 Apk</p> <p>With MXR/EXR oscilloscope secondary channels (channel 5 to 8) DC: 15Adc, Continuous AC: 10Arms, 15Apeak Non-continuous AC: 30 Apk</p>
Maximum peak current	50A (for Pulse Widths ≤ 10μs)
Probe sensitivity	0.1V/A
Noise	≤ 2.5 mA _{rms} (with 20 MHz Bandwidth limiting)
Insertion impedance	Refer to Figure 11 on page 24 .
Temperature coefficient	≤ ±2% (0°C to 40°C)
Effect of external magnetic fields	Equivalent to ≤ 20 mA (for a 400 A/m magnetic field, DC to 60 Hz)

Table 2 Measurement Characteristics

Item	Characteristic ^a
Maximum circuit voltage	300V Mains Isolated (refer to safety considerations and product compliances)

- a.Requires 1M Ω termination. Valid for 23°C \pm 3°C (73°F \pm 5°F), at least 30 minutes after power on.
- b.This is a specification and is guaranteed at 23°C \pm 3°C (73°F \pm 5°F).
- c.Rise time is calculated as: Tr = 0.35/Bandwidth.

Table 3 Power Supply Characteristics

Item	Characteristics
DC supply voltage requirements	\pm 12Vdc \pm 1V
Probe power consumption	Increases with measured current. 3 VA when measuring 15A

Table 4 Mechanical Characteristics

Item	Characteristics
Maximum cable diameter	5 mm (0.2 inch)
Sensor cable length	1.5 m (59 inches)
Power cable length	1 m (39 inches)
Dimensions (Sensor)	175 mm x 18 mm x 40 mm 6.89 in. x 0.71 in. x 1.6 in.
Dimensions (Terminator)	28 mm x 81 mm x 24 mm 1.1 in. x 3.2 in. x 0.94 in
Weight	210 g (7.4 oz.)
Accessories supplied	Storage case, calibration certificate

Table 5 Environmental Characteristics

Item	Characteristics
Use	Indoor
Operating temperature range	0°C to 40°C (32°F to 104°F)
Storage temperature range	-10°C to 50°C (14°F to 122°F)

Table 5 Environmental Characteristics

Item	Characteristics
Maximum relative humidity (operating or storage)	80% (no condensation)
Vibration (10 to 55 Hz)	30 min/axis 10 octave/min Amplitude 0.3 mm
Vibration (55 Hz)	30 min/axis Amplitude 0.3 mm Acceleration 17.91 m/s ²
Maximum Altitude	2000m

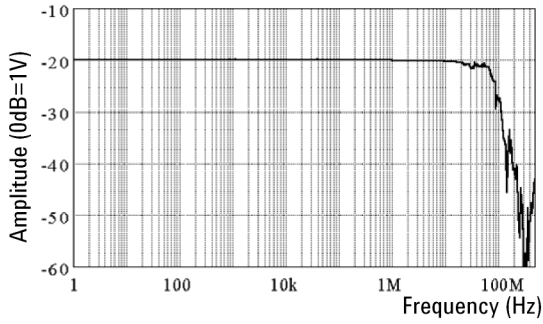

Figure 9 Frequency Characteristic

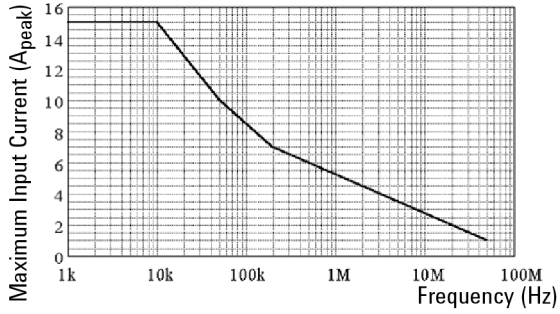

Figure 10 Derating According to Frequency

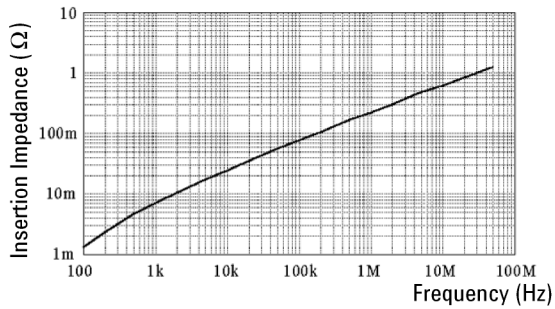







Figure 11 Insertion Impedance

Product Markings and Labels

Table 6 Instrument Markings

Marking	Description
 300 V CAT I UNINSULATED CORE	Indicates the maximum circuit voltage and product compliance.
	This symbol indicates the Environmental Protection Use Period (EPUP) for the product's toxic substances for the China RoHS requirements.
	The CE symbol indicates the European Community.
	CAUTION. Risk of Danger. Refer to this manual for more information.
	This mark indicates the Australian Spectrum Management Agency.
	WEEE Directive notice. This marking is on a notice sticker and is not actually fixed to the product.

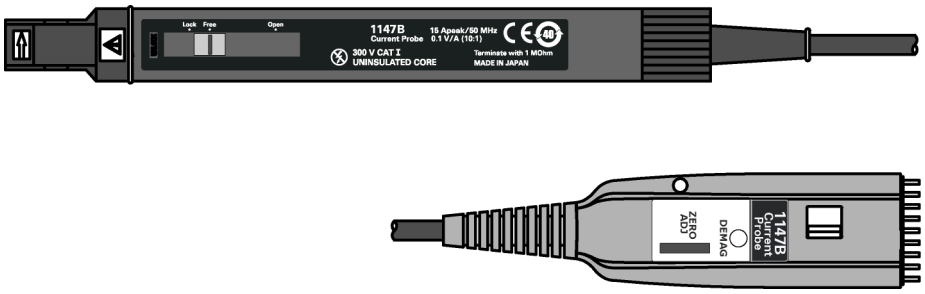

Figure 12 Product Labels

Service Strategy

For repair and calibration testing, return the 1147B probe to a Keysight Service Center. If the probe is under warranty, normal warranty services apply. If the probe is not under warranty, repair costs will be applied.

To return the Probe to Keysight Technologies, Inc. for Service

Call (800) 829-4444 for further details and the location of your nearest Keysight Technologies, Inc. Service Office or go to www.keysight.com/find/assist for contact information.

- 1 Write the following information on a tag and attach it to the probe.
 - Name and address of the owner
 - Probe model number
 - Description of service required or failure indications
- 2 Retain all accessories.
- 3 Return the probe in its case or pack the probe in foam or other shock-absorbing material and place it in a strong shipping container. You can use the original shipping materials or order materials from a Keysight Technologies, Inc. Sales Office. If neither are available, place 3 to 4 inches of shock-absorbing material around the instrument and place it in a box that does not allow movement during shipping.
- 4 Seal the shipping container securely.
- 5 Mark the shipping container as FRAGILE. In all correspondence, refer to the instrument by model number and full serial number.

Index

- A**
AC accuracy 18
accuracy 21
AutoProbe 13
- B**
built-in safety circuit 8
- C**
cable diameter 22
CE symbol 25
characteristics and specifications 21
China RoHS requirements 25
cleaning 10
coarse adjustment trimmer 12
current direction indicator 14
- D**
DC supply voltage requirements 22
DEMAG 11, 16
demagnetization and zero adjustment 16
demagnetizing switch 11
derating according to frequency 24
dimensions (sensor) 22
dimensions (terminator) 22
- E**
external magnetic fields 15, 21
- F**
Frequency Characteristic 24
- H**
high frequencies 14
high transient time signals 5
- I**
IEC 61010-1 Safety Standards 6
impedance, insertion 21
insertion impedance 21, 24
inspection 5
instrument markings 25
ISM1-A 25
- L**
labels 25
- M**
maximum altitude 23
maximum cable diameter 22
maximum circuit voltage 22
maximum current 21
maximum peak current 21
maximum relative humidity 23
measurement procedure 13
- N**
noise 21
- O**
opening lever 11
opening sensor head 14
operating temperature range 22
Overvoltage Category I 6
- P**
power cable length 22
probe bandwidth 21
probe parts identification 11
probe power consumption 22
probe sensitivity 21

R

risetime 21

S

safety warnings 6

SELV-E 6

sensitivity 21

sensor cable length 22

sensor head 11

service 26

sound 15

storage temperature range 22

T

temperature coefficient 21

temperature range 22

U

use 22

using 14

V

vibration 23

W

weight 22

Z

ZERO ADJ 12, 16

zero adjustment dial 12