



PXIE-SCP5104 Bundle

Expandable PXI bundle based on PXIe-5172
Oscilloscope, 100 MHz, 14 bits, 8 Channels, 1.5 GB

Specifications

PXIE-1083 and PXIE-5172



Ihr Ansprechpartner /
Your Partner:

dataTec AG
E-Mail: info@datatec.eu
>>> www.datatec.eu

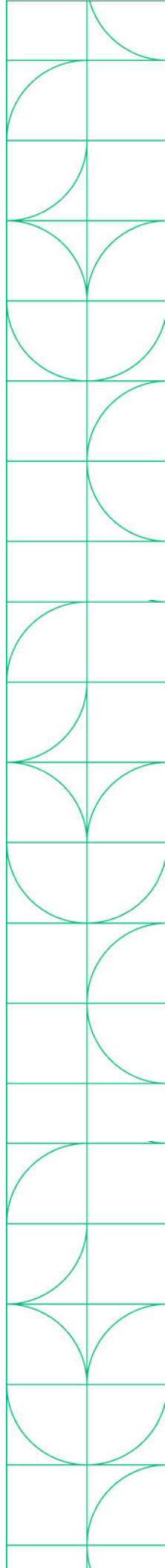

PXI Oscilloscope Bundle

In the Box

PXIe-SCP5104 Bundle Bundle P/N: 867014-01



PXIe-5172
(Oscilloscope)



PXIe-1083
(5-Slot PXIe Chassis)

Accessories:

- SMB Female to Mini-Alligator Clips (x2)
- Thunderbolt cable
- Power cable, US

Recommended Software

Test Workflow P/N: 788509-35



Test Workflow is a bundle of select NI software featuring engineering-specific tools that help test professionals accomplish anything from their day-to-day work to overcoming their most challenging obstacles.

Test Workflow includes:

- **LabVIEW** - a graphical programming environment engineers use to develop automated research, validation, and production test systems.
- **InstrumentStudio** - an application software that provides an integrated approach to interactive PXI measurements.
- **TestStand** - a test executive software that accelerates system development and deployment for engineers in validation and production.
- And more NI Software!

Table of Contents

This document combines the PDFs of this bundle together. The page numbers in the table of contents correspond to the page number of PDF the component's documentation begins.

PXIe-1083 Specifications.....	3
PXIe-5172 Specifications.....	16



PXle-1083 Specifications



PXIe-1083 Specifications

This document contains specifications for the PXIe-1083 chassis.

Electrical

The following section provides information about the PXIe-1083 AC input and DC output.

AC Input

Input rating	100 VAC to 240 VAC, 50 Hz/60 Hz, 6 A to 3 A
Operating voltage range ¹	90 VAC to 264 VAC
Nominal input frequency	50 Hz/60 Hz
Operating frequency range ¹	47 Hz to 63 Hz
Efficiency	78% typical
Over-current protection	Internal fuse in line
Main power disconnect	The AC power cable provides main power disconnect. Do not position the equipment so that it is difficult to disconnect the power cord. The front-panel power switch causes the internal chassis power supply to provide DC power to the PXI Express backplane.



Caution Disconnect power cord to completely remove power.

DC Output

DC output characteristics of the PXIe-1083.

Voltage Rail	Maximum Current	Load Regulation	Maximum Ripple and Noise (20 MHz BW)
+5V_AUX	1.0 A	±5%	50 mVpp
+12 V	30.1 A	±5%	120 mVpp
+5 V	25.1 A	±5%	50 mVpp
+3.3 V	30.7 A	±5%	50 mVpp
-12 V	0.75 A	±5%	120 mVpp

Maximum total available power for the PXIe-1083 is 293 W.

The maximum combined power available on +3.3 V and +5 V is 180 W.

The maximum power available for each Thunderbolt port is 15 W (5 V/3 A).

Table 1. Backplane Slot Current Capacity

Slot	+5 V	V (I/O)	+3.3 V	+12 V	-12 V	5 V _{AUX}
Hybrid Peripheral Slot with PXI-5 Peripheral	-	-	3 A	6 A	-	1 A
Hybrid Peripheral Slot with PXI-1 Peripheral	6 A	5 A	6 A	1 A	1 A	-



Note PCI V(I/O) pins in Hybrid Peripheral Slots are connected to +5 V.



Note The maximum power dissipated in a peripheral slot should not exceed 58 W. Refer to the **Operating Environment** section for ambient temperature considerations at 58 W.

Over-current protection	All outputs are protected from short circuit and overload, they recover and return to regulation when the overload is removed and the power is cycled.
Over-voltage protection	+3.3 V clamped at 3.7 V to 4.3 V, +5 V clamped at 5.7 V to 6.5 V, +12 V clamped at 13.4 V to 15.6 V

Chassis Cooling

Module cooling	Forced air circulation (positive pressurization) through one 150 CFM fan
Module slot airflow direction	Bottom of module to top of module
Module intake	Bottom of chassis
Module exhaust	Top, right side of chassis
Slot cooling capacity	58 W; slot 6 supports 58 W cooling with high fan mode
Power supply cooling	Forced air circulation through integrated fans
Power supply intake	Front and left side chassis
Power supply exhaust	Rear of chassis
Minimum chassis cooling clearances	
Above	44.45 mm (1.75 in.)
Rear	44.45 mm (1.75 in.)
Sides	44.45 mm (1.75 in.)
Below	
Rack	44.45 mm (1.75 in.)
Desktop	25.4 mm (1.00 in.)

Environmental

Maximum altitude	2,000 m (6,560 ft.), 800 mbar (at 25 °C ambient, high fan mode)
Pollution Degree	2

Indoor use only.

Operating Environment

<p>Ambient temperature range</p> <p>When all peripheral modules require ≤ 38 W cooling capacity per slot</p> <p>0 °C to 50 °C (IEC 60068-2-1 and IEC 60068-2-2.)² Meets MIL-PRF-28800F Class 3 low temperature limit and high temperature limit.</p> <p>When any peripheral module requires > 38 W cooling capacity per slot</p> <p>0 °C to 40 °C (IEC 60068-2-1 and IEC 60068-2-2.)² Meets MIL-PRF-28800F Class 3 low temperature limit and MIL-PRF-28800F Class 4 high temperature limit.</p>	
Relative humidity range	20% to 80%, noncondensing

Storage Environment

Ambient temperature range	-40 °C to 71 °C (IEC-60068-2-1 and IEC-60068-2-2.) ^[3] Meets MIL-PRF-28800F Class 3 limits.
Relative humidity range	10% to 95%, noncondensing

Shock and Vibration

Operational shock	30 g peak, half-sine, 11 ms pulse (IEC-60068-2-27.) ³ Meets MIL-PRF-28800F Class 2 limits.
Operational random vibration	5 to 500 Hz, 0.3 g _{rms}
Non-operating vibration	5 to 500 Hz, 2.4 g _{rms} (IEC 60068-2-64.) ³ Non-operating test profile exceeds the requirements of MIL-PRF-28800F, Class 3.

Acoustic Emissions

Sound Pressure Level (at Operator Position)

(Tested in accordance with ISO 7779. Meets MIL-PRF-28800F requirements.)

38 W Profile

Auto fan (up to 30 °C ambient)	33.7 dBA
High fan	50.8 dBA

58 W Profile

Auto fan (up to 30 °C ambient)	54.7 dBA
High fan	55.3 dBA

Sound Power Level

38 W Profile

Auto fan (up to 30 °C ambient)	44.9 dBA
High fan	60.3 dBA

58 W Profile	
Auto fan (up to 30 °C ambient)	63.4 dBA
High fan	64.2 dBA



Note The protection provided by the PXIe-1083 can be impaired if it is used in a manner not described in this document.

Safety Compliance Standards

This product is designed to meet the requirements of the following electrical equipment safety standards for measurement, control, and laboratory use:

- IEC 61010-1, EN 61010-1
- UL 61010-1, CSA C22.2 No. 61010-1



Note For safety certifications, refer to the product label or the [Product Certifications and Declarations](#) section.

EMC Guidelines

This product was tested and complies with the regulatory requirements and limits for electromagnetic compatibility (EMC) stated in the product specifications. These requirements and limits provide reasonable protection against harmful interference when the product is operated in the intended operational electromagnetic environment.

This product is intended for use in industrial locations. However, harmful interference may occur in some installations, when the product is connected to a peripheral device or test object, or if the product is used in residential areas. To minimize interference with radio and television reception and prevent unacceptable performance degradation, install and use this product in strict accordance with the instructions in the product documentation.

Furthermore, any changes or modifications to the product not expressly approved by NI could void your authority to operate it under your local regulatory rules.

EMC Notices

Refer to the following notices for cables, accessories, and prevention measures necessary to ensure the specified EMC performance.



Notice

For EMC declarations and certifications, and additional information, refer to the [Product Certifications and Declarations](#) section.



Notice Changes or modifications to the product not expressly approved by NI could void your authority to operate the product under your local regulatory rules.



Notice Operate this product only with shielded cables and accessories.

Electromagnetic Compatibility Standards

This product meets the requirements of the following EMC standards for electrical equipment for measurement, control, and laboratory use:

- EN 61326-1 (IEC 61326-1): Class A emissions; Basic immunity
- EN 55011 (CISPR 11): Group 1, Class A emissions

- AS/NZS CISPR 11: Group 1, Class A emissions



Note Group 1 equipment (per CISPR 11) is any industrial, scientific, or medical equipment that does not intentionally generate radio frequency energy for the treatment of material or inspection/analysis purposes.



Note In Europe, Canada, Australia, and New Zealand (per CISPR 11) Class A equipment is intended for use in nonresidential locations.

CE Compliance

This product meets the essential requirements of applicable European Directives, as follows:

- 2014/35/EU; Low-Voltage Directive (safety)
- 2014/30/EU; Electromagnetic Compatibility Directive (EMC)
- 2011/65/EU; Restriction of Hazardous Substances (RoHS)

Product Certifications and Declarations

Refer to the product Declaration of Conformity (DoC) for additional regulatory compliance information. To obtain product certifications and the DoC for NI products, visit ni.com/product-certifications, search by model number, and click the appropriate link.

Environmental Management

NI is committed to designing and manufacturing products in an environmentally responsible manner. NI recognizes that eliminating certain hazardous substances from our products is beneficial to the environment and to NI customers.

For additional environmental information, refer to the **Engineering a Healthy Planet** web page at ni.com/environment. This page contains the environmental

regulations and directives with which NI complies, as well as other environmental information not included in this document.

EU and UK Customers

-  Waste Electrical and Electronic Equipment (WEEE)—At the end of the product life cycle, all NI products must be disposed of according to local laws and regulations. For more information about how to recycle NI products in your region, visit ni.com/environment/weee.

电子信息产品污染控制管理办法 (中国 RoHS)

-  中国 RoHS— NI 符合中国电子信息产品中限制使用某些有害物质指令(RoHS)。关于 NI 中国 RoHS 合规性信息，请登录 ni.com/environment/rohs_china。(For information about China RoHS compliance, go to ni.com/environment/rohs_china.)

Backplane

Size	3U-sized; 5 peripheral slots. Compliant with IEEE 1101.10 mechanical packaging. PXI Express Specification compliant. Accepts both PXI Express and CompactPCI (PICMG 2.0 R 3.0) 3U modules.
Backplane bare-board material	UL 94 V-0 Recognized
Backplane connectors	Conforms to IEC 917 and IEC 1076-4-101, UL 94 V-0 rated

System Synchronization Clocks

10 MHz System Reference Clock: PXI_CLK10

Maximum slot-to-slot skew	250 ps
Accuracy	± 25 ppm max (guaranteed over the operating temperature range)
Maximum jitter	5 ps RMS phase-jitter (10 Hz–1 MHz range)
Duty-factor	45% to 55%
Unloaded signal swing	3.3 V \pm 0.3 V



Note For other specifications, refer to the **PXI-1 Hardware Specification**.

100 MHz System Reference Clock: PXIe_CLK100 and PXIe_SYNC100

Maximum slot-to-slot skew	100 ps
Accuracy	± 25 ppm max (guaranteed over the operating temperature range)
Maximum jitter	3 ps RMS phase-jitter (10 Hz to 12 kHz range), 2 ps RMS phase-jitter (12 kHz to 20 MHz range)
Duty-factor for PXIe_CLK100	45% to 55%
Absolute differential voltage (When terminated with a 50 Ω load to 1.30 V or Thévenin equivalent)	400 mV to 1000 mV



Note For other specifications, refer to the **PXI-5 PXI Express Hardware Specification**.

Mechanical

Standard chassis dimensions	
Height	177.1 mm (6.97 in.)
Width	257.1 mm (10.12 in.)
Depth	214.2 mm (8.43 in.)
Weight	6.7 kg (14.8 lb)
Chassis materials	Extruded Aluminum (6063-T5, 6060-T6), Cold Rolled Steel/Stainless Steel, Santoprene, Urethane Foam, PC-ABS, Nylon, Polyethylene
Finish	Conductive Clear Iridite on Aluminum, Electroplated Nickel on Cold Rolled Steel, Electroplated Zinc on Cold Rolled Steel

The following figures show the PXIe-1083 chassis dimensions. The holes shown are for installing the optional rack mount kits.

Figure 1. PXIe-1083 Chassis Dimensions (Front)

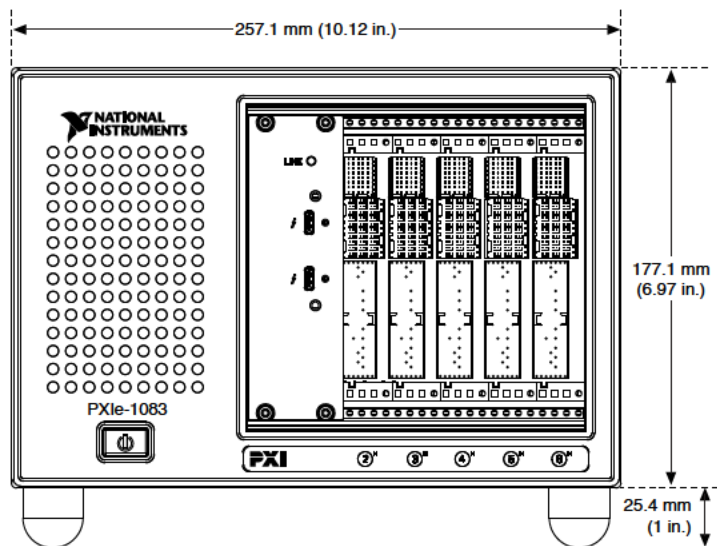

Figure 2. PXIe-1083 Chassis Dimensions (Side)

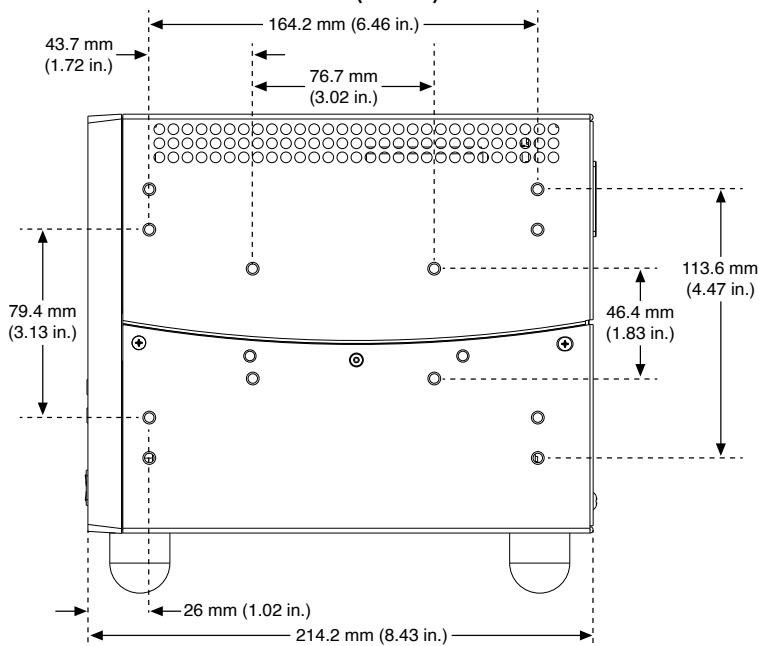
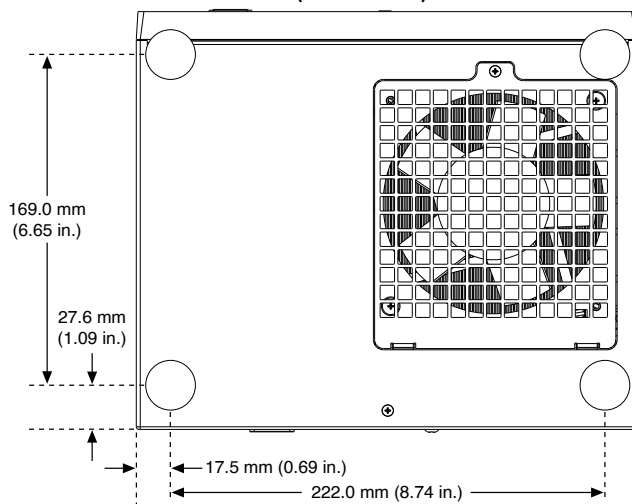

Figure 3. PXIe-1083 Chassis Dimensions (Bottom)



¹ The operating range is guaranteed by design.

² This product meets the requirements of the environmental standards for electrical equipment for measurement, control, and laboratory use.

³ This product meets the requirements of the environmental standards for electrical equipment for measurement, control, and laboratory use.

PXle-5172

Specifications

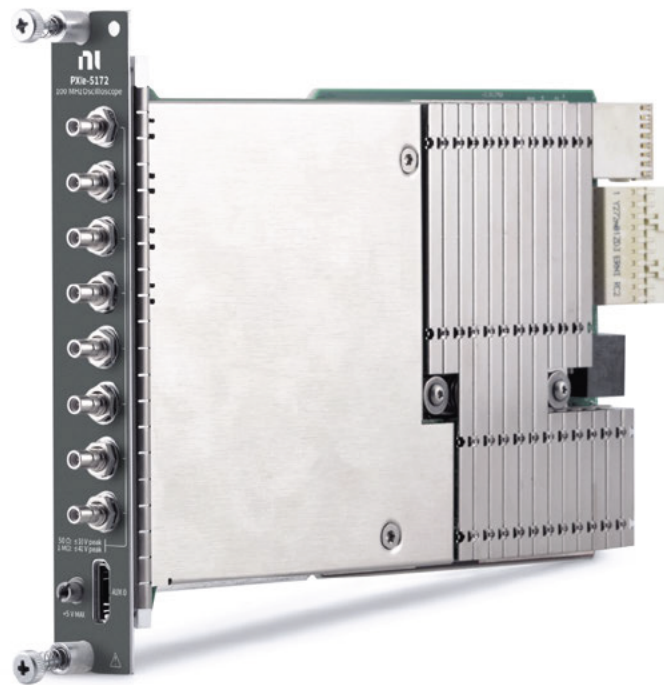

PXIe-5172 Specifications

These specifications apply to the PXIe-5172 with 4 channels and the PXIe-5172 with 8 channels.

Definitions

Warranted specifications describe the performance of a model under stated operating conditions and are covered by the model warranty. Warranted specifications account for measurement uncertainties, temperature drift, and aging. Warranted specifications are ensured by design or verified during production and calibration.

Characteristics describe values that are relevant to the use of the model under stated operating conditions but are not covered by the model warranty.

- **Typical** specifications describe the performance met by a majority of models.
- **Nominal** specifications describe an attribute that is based on design, conformance testing, or supplemental testing.
- **Measured** specifications describe the measured performance of a representative model.

Specifications are **Nominal** unless otherwise noted.

Conditions

Specifications are valid under the following conditions unless otherwise noted.

- All vertical ranges
- All bandwidths and bandwidth limiting filters
- Sample rate set to 250 MS/s
- Onboard sample clock locked to onboard reference clock

- PXIe-5172 module warmed up for 15 minutes at ambient temperature.^[1]
- Calibration IP used properly when using LabVIEW Instrument Design Libraries for Reconfigurable Oscilloscopes (instrument design libraries) to create FPGA bitfiles. Refer to the **NI Reconfigurable Oscilloscopes Help** for more information about the calibration API.

Warranted specifications are valid under the following conditions unless otherwise noted.

- Ambient temperature range of 0 °C to 45 °C
- Chassis configured:^[2]
 - PXI Express chassis fan speed set to HIGH
 - Foam fan filters removed if present
 - Empty slots contain PXI chassis slot blockers and filler panels
- External calibration cycle maintained
- External calibration performed at 23 °C±3 °C

Typical specifications are valid under the following conditions unless otherwise noted.

- Ambient temperature range of 0 °C to 45 °C

Nominal and Measured specifications are valid under the following conditions unless otherwise noted.

- Room temperature, approximately 23 °C

Vertical

Analog Input

Number of channels

PXIe-5172 (4 CH)

Four (simultaneously sampled)

PXIe-5172 (8 CH)	Eight (simultaneously sampled)
Input type	Referenced single-ended
Connectors	SMB, ground referenced

Impedance and Coupling

Input impedance	50 Ω \pm 1.5%, typical 1 M Ω \pm 0.5%, typical
Input capacitance (1 M Ω)	16 pF \pm 1.2 pF, typical
Input coupling	AC DC

Figure 1. 50 Ω Voltage Standing Wave Ratio (VSWR), Measured

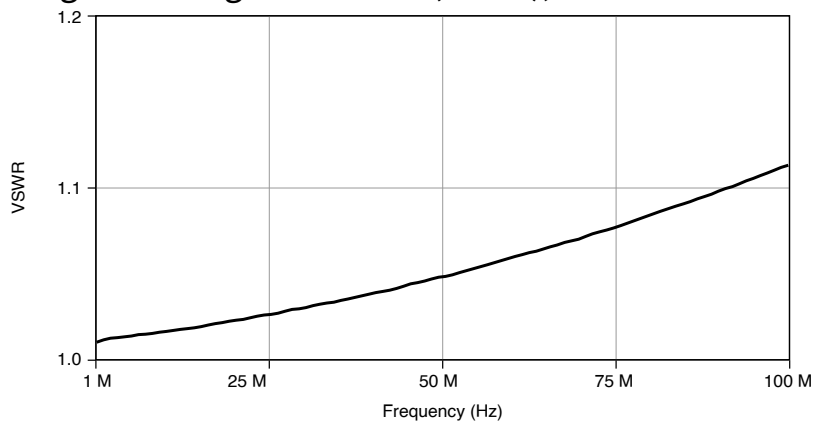
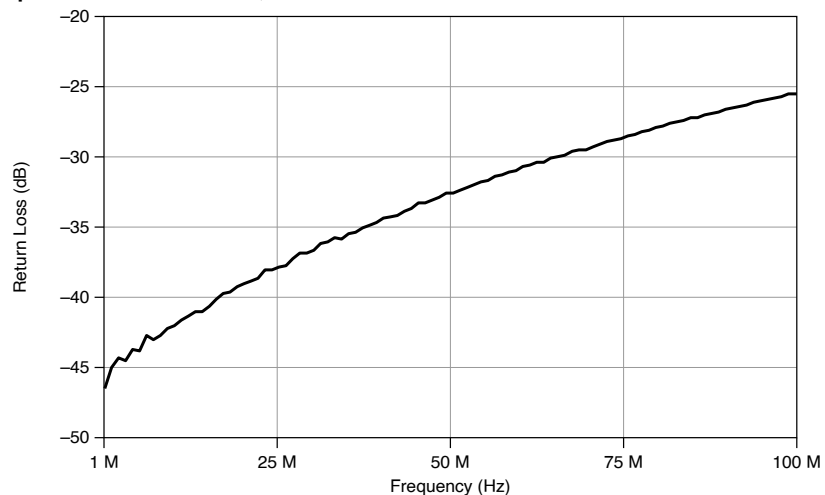

Figure 2. 50 Ω Input Return Loss, Measured

Voltage Levels

Table 1. 50 Ω FS Input Range and Vertical Offset Range

Input Range (V_{pk-pk})	Vertical Offset Range (V)
0.2 V	± 0.5
0.7 V	± 0.5
1.4 V	± 0.5
5 V	± 2.5
10 V ^[3]	0

Table 2. 1 M Ω FS Input Range and Vertical Offset Range

Input Range (V_{pk-pk})	Vertical Offset Range (V)
0.2 V	± 0.5
0.7 V	± 0.5
1.4 V	± 0.5
5 V	± 4.5
10 V	± 4.5
40 V	± 20
80 V	0

Maximum input overload

50 Ω	7 V RMS with Peaks \leq 10 V
-------------	----------------------------------

1 M Ω	Peaks \leq 42 V
--------------	--------------------



Notice Signals exceeding the maximum input overload may cause damage to the device.

Accuracy

Resolution	14 bits
DC accuracy^[4]	
50 Ω	$\pm[(0.45\% \times \mathbf{Reading} - \mathbf{Vertical\ Offset}) + (0.4\% \times \mathbf{Vertical\ Offset}) + (0.05\% \text{ of FS}) + 0.4 \text{ mV}]$, warranted
1 M Ω , 40 V _{pk-pk} range	$\pm[(0.45\% \times \mathbf{Reading} - \mathbf{Vertical\ Offset}) + (0.5\% \times \mathbf{Vertical\ Offset}) + (0.05\% \text{ of FS}) + 0.4 \text{ mV}]$, warranted
1 M Ω , all other ranges	$\pm[(0.45\% \times \mathbf{Reading} - \mathbf{Vertical\ Offset}) + (0.4\% \times \mathbf{Vertical\ Offset}) + (0.05\% \text{ of FS}) + 0.4 \text{ mV}]$, warranted
DC drift ^[5]	$\pm[(0.010\% \times \mathbf{Reading} - \mathbf{Vertical\ Offset}) + (0.003\% \times \mathbf{Vertical\ Offset}) + (0.006\% \text{ of FS})]$ per $^{\circ}\text{C}$
AC amplitude accuracy^[4]	
50 Ω	$\pm 0.15 \text{ dB}$ at 50 kHz, warranted
1 M Ω , 40 V _{pk-pk} and 80 V _{pk-pk} ranges	$\pm 0.25 \text{ dB}$ at 50 kHz, warranted
1 M Ω , all other ranges	$\pm 0.15 \text{ dB}$ at 50 kHz, warranted

Conversion error rate ^[6]	
250 MS/sec	$<1 \times 10^{-10}$
200 MS/sec	$<1 \times 10^{-15}$
150 MS/sec	$<1 \times 10^{-20}$

Table 3. Crosstalk^[7]

Frequency	Level		
	50 Ω	1 M Ω , 0.2 V _{pk-pk} to 10 V _{pk-pk} Range	1 M Ω , 40 V _{pk-pk} Range
1 MHz	-75 dB	-75 dB	-65 dB
50 MHz	-75 dB	-75 dB	
100 MHz	-70 dB	-70 dB	



Notice This device may experience increased peak to peak noise when connected cables are routed in an environment with radiated or conducted electromagnetic interference. To limit the effects of this interference and to ensure that this device functions within specifications, take precautions when designing, selecting, and installing measurement probes and cables.

Bandwidth and Transient Response

Table 4. Bandwidth (-3 dB), Warranted^[8]

Input Impedance	Input Range (V _{pk-pk})	Bandwidth
50 Ω	0.2 V	99 MHz
	All other input ranges	100 MHz
1 M Ω ^[9]	All input ranges	98 MHz
Bandwidth-limiting filters (digital FIR) ^{[8],[10]}		20 MHz noise filter

	40 MHz noise filter 80 MHz noise filter ^[11]
AC-coupling cutoff (-3 dB) ^[12]	16.50 Hz
Rise/fall time^[13]	
50 Ω	5.15 ns
1 M Ω	5.25 ns

Figure 3. 50 Ω Full Bandwidth Frequency Response, 1.4 V_{pk-pk}, Measured

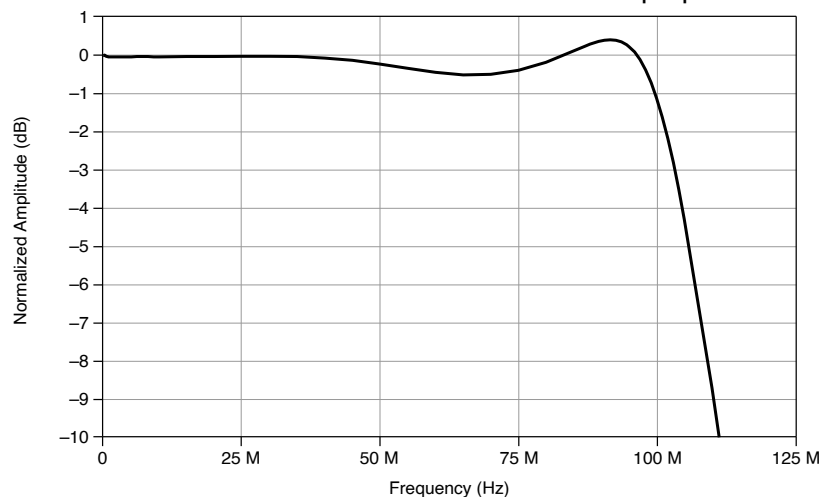

Spectral Characteristics^[14]

Table 5. Spurious-Free Dynamic Range (SFDR), 50 Ω and 1 M Ω ^[15]

Input Range (V _{pk-pk})	Full Bandwidth, Input Frequency \leq 30 MHz
0.2 V	-70 dBc
0.7 V	-78 dBc
1.4 V	-71 dBc
5 V	-80 dBc

Table 6. Total Harmonic Distortion (THD), 50 Ω and 1 M Ω ^[16]

Input Range (V_{pk-pk})	Full Bandwidth, Input Frequency ≤ 30 MHz
0.2 V	-74 dBc
0.7 V	-77 dBc
1.4 V	-70 dBc
5 V	-77 dBc

Table 7. Effective Number of Bits (ENOB), 50 Ω and 1 M Ω ^[15]

Input Range (V_{pk-pk})	20 MHz Filter Enabled, Input Frequency ≤ 10 MHz	Full Bandwidth, Input Frequency > 10 MHz, ≤ 30 MHz
0.2 V	9.8	9.5
0.7 V	11.4	10.8
1.4 V	11.9	10.8
5 V	11.8	11.0

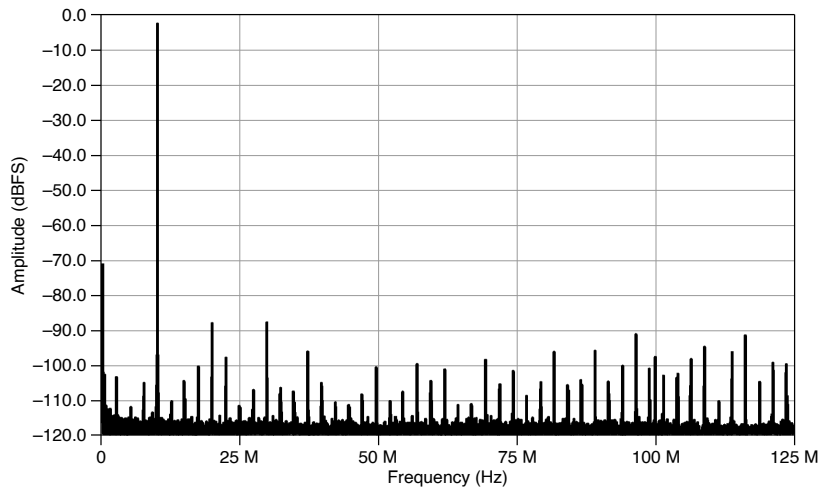
Figure 4. 50 Ω Single-Tone Spectrum, 1.4 V_{pk-pk} Input Range, Full Bandwidth, 9.9 MHz Input Tone at -1 dBFS, Measured

Noise^[17]

Table 8. RMS Noise, 50 Ω and 1 M Ω , Warranted

Input Range (V_{pk-pk})	RMS Noise (% of Full Scale)
0.2 V	0.045
All other input ranges	0.018

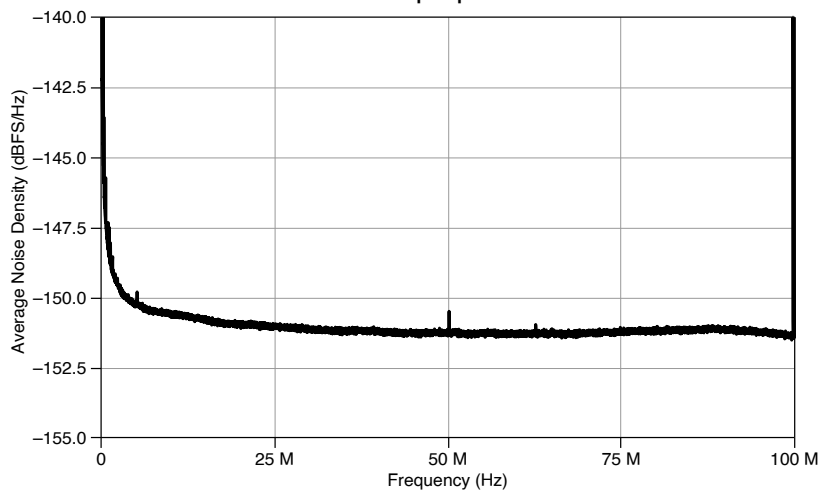
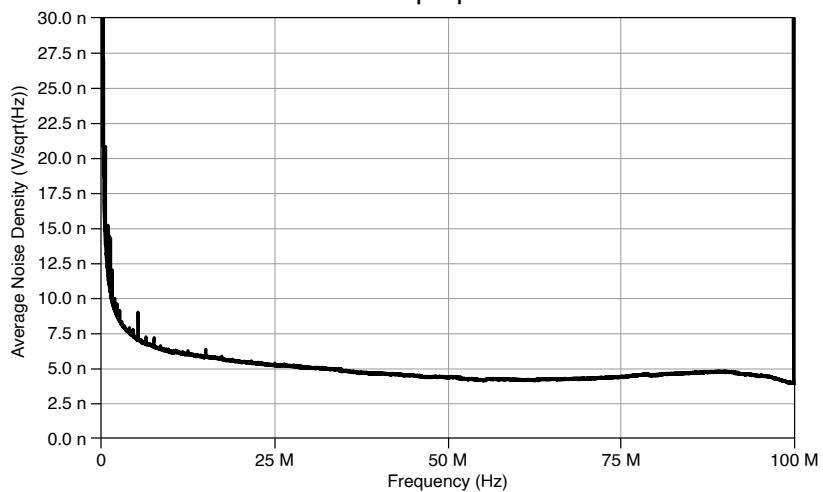
Figure 5. 50 Ω Average Noise Density, 1.4 V_{pk-pk} Range, MeasuredFigure 6. 50 Ω Average Noise Density, 0.2 V_{pk-pk} Range, Measured

Skew

Channel-to-channel skew ^[18]	<120 ps
---	---------

Horizontal

Sample Clock

Sources

Internal	Onboard clock (internal VCXO)	
External	AUX 0 CLK IN (front panel MHDMR connector) PXIe_DStarA (backplane connector)	
Sample rate range, real-time ^[19]		3.815 kS/s to 250 MS/s
Sample clock jitter ^[20]		700 fs RMS
Timebase frequency		
Internal (software-selectable)		250 MHz
		200 MHz
		150 MHz
External		150 MHz to 250 MHz
Timebase accuracy		
Phase-locked to onboard clock		±25 ppm, warranted
Phase-locked to external clock		Equal to the external clock accuracy
DC accuracy sampling drift, ±(% of Reading) per MHz from 250 MHz ^[21]		±0.0127
Duty cycle tolerance		45% to 55%

Phase-Locked Loop (PLL) Reference Clock

Sources

Internal	None (internal VCXO)
	Onboard clock (internal VCXO)
	PXI_Clk10 (backplane connector)
External (10 MHz) ^[22]	AUX 0 CLK IN (front panel MHDMM connector)
Duty cycle tolerance	45% to 55%

External Sample Clock

Source	AUX 0 CLK IN (front panel MHDMM connector)	
Impedance	50 Ω	
Coupling	AC	
Input voltage range		
As a 250 MHz sine wave	1 dBm through 18 dBm	
As a fast slew rate input (square wave, V_{pk-pk})	0.4 V to 5 V	
Maximum input overload		
As a 250 MHz sine wave	20 dBm	
As a fast slew rate input (square wave, V_{pk-pk})	6 V	

External Reference Clock In

Source	AUX 0 CLK IN (front panel MHDMR connector)	
Impedance	50 Ω	
Coupling	AC	
Frequency ^[23]	10 MHz	
Input voltage range		
As a 250 MHz sine wave	1 dBm through 18 dBm	
As a fast slew rate input (square wave, V_{pk-pk})	6 V	
Duty cycle tolerance	45% to 55%	

Reference Clock Out

Source	PXI_Clk10 (backplane connector)
Destination	AUX 0 CLK OUT
Output impedance	50 Ω
Logic type	3.3 V LVCMOS
Maximum current drive	± 8 mA

PXIe_DStarA

Source	System timing slot
Destinations	Onboard clock (internal VCXO) FPGA

PXI_Clk10

Source	PXI backplane
Destination	Reference clock

PXI_Clk100

Source	PXI backplane
Destination	FPGA

Trigger^[24]

Supported triggers	Reference (stop) trigger Reference (arm) trigger Start trigger Advance trigger
Trigger types	Edge

	Hysteresis Window Digital Immediate Software
Dead time	Sample clock period × 10
Holdoff	From Dead time to $[(2^{64} - 1) \times \text{Sample clock period}]$
Delay	From 0 to $[(2^{51} - 1) \times \text{Sample clock period}]$

Analog Trigger

Sources	
PXIe-5172 (4 CH)	CH <0..3>
PXIe-5172 (8 CH)	CH <0..7>

Table 9. Analog Trigger Time Resolution and Rearm Time

Interpolator Status	Time Resolution	Rearm Time
Enabled	Sample clock period / 1024	Sample clock period × 124
Disabled	Sample clock period	Sample clock period × 84

Trigger accuracy ^[25]	
Input range (V_{pk-pk}): 0.2 V	0.75% of FS

Input range (V_{pk-pk}): 0.7 V, 1.4 V, 5 V	0.5% of FS
Trigger jitter ^[25]	15 ps RMS
Minimum threshold duration ^[26]	Sample clock period

Digital Trigger

Sources	AUX 0 PFI <0..7> PXI_Trig <0..6>
Time resolution	Sample clock period × 2
Rearm time	Sample clock period × 84

Software Trigger

Destinations	Reference (stop) trigger Reference (arm) trigger Start trigger Advance trigger
Time resolution	Sample clock period × 2
Rearm time	Sample clock period × 84

Programmable Function Interface

Connector	AUX 0 PFI <0..7> (front panel MHDMR connector)
Direction	Bidirectional per channel
Direction control latency	125 ns
As an input (trigger)	
Destinations	<p>FPGA diagram</p> <p>Start trigger (acquisition arm)</p> <p>Reference (stop) trigger</p> <p>Arm Reference trigger</p> <p>Advance trigger</p>
Input impedance	49.9 k Ω
V_{IH}	2 V
V_{IL}	0.8 V
Maximum input overload	0 V to 3.3 V (5 V tolerant)
Minimum pulse width	10 ns
As an output (event)	
Sources	<p>FPGA diagram</p> <p>Ready for Start</p>

	Start trigger (acquisition arm)
	Ready for Reference
	Reference (stop) trigger
	End of Record
	Ready for Advance
	Advance trigger
	Done (End of Acquisition)
Output impedance	50 Ω
Logic type	3.3 V CMOS
Maximum current drive	12 mA
Minimum pulse width	10 ns

Power Output (+3.3 V)

Connector	AUX 0 +3.3 V (front panel MHDMMR connector)
Voltage output	3.3 V \pm 10%
Maximum current drive	200 mA
Output impedance	<1 Ω

Waveform

Onboard memory size^[27]	
PXIe-5172 (4 CH)	
PXIe-5172 (8 CH)	1.5 GB
Minimum record length	1 sample
Number of pretrigger samples	Zero up to (Record length - 1)
Number of posttrigger samples	Zero up to Record length
Maximum number of records in onboard memory	Total onboard memory / 48 × Number of channels , where number of channels is the number of channels enabled rounded up to the nearest power of two

Figure 7. Allocated Onboard Memory Per Record

$$\text{Roundup}\left(\text{Roundup}\left(\frac{\text{Coerced number of samples} + \text{Number of samples per sample word}}{\text{Number of samples per memory word}}\right) \times \text{Number of samples per memory word} + 3 \times \text{Number of samples per memory word}\right) \times \text{Bytes per sample} \times \text{Number of channels}$$

where

- **Number of samples per sample word** = 16 samples / **number of channels**
- **Number of samples per memory word** = 48 samples / **number of channels**
- **Coerced number of samples** is the number of pretrigger samples rounded up to the next multiple of **Number of samples per sample word** + the number of posttrigger samples rounded up to the next multiple of **number of samples per sample word**

- **Number of channels** is the number of channels enabled rounded up to the nearest power of two

Memory Sanitization

For information about memory sanitization, refer to the letter of volatility for your device, which is available at ni.com/manuals.

FPGA

FPGA support	
PXIe-5172 (4 CH)	Xilinx Kintex-7 XC7K325T FPGA
PXIe-5172 (8 CH)	Xilinx Kintex-7 XC7K325T FPGA
	Xilinx Kintex-7 XC7K410T FPGA

Table 10. FPGA Resources

Resource Type	Xilinx Kintex-7 XC7K325T	Xilinx Kintex-7 XC7K410T
Slice registers	407,600	508,400
Slice look-up tables (LUT)	203,800	254,200
DSPs	840	1,540
18 Kb block RAMs	890	1,590



Note Some of these FPGA resources are consumed by the logic necessary to operate the device and integrate with software and are thus out of the control of users.

Calibration

External Calibration

External calibration yields the following benefits:

- Corrects for gain and offset errors of the onboard references used in self-calibration.
- Adjusts timebase accuracy.
- Compensates the 1 M Ω ranges.

All calibration constants are stored in nonvolatile memory.

Self-Calibration

Self-calibration is done on software command. The calibration corrects for the following aspects:

- Gain
- Offset
- Intermodule synchronization errors

Refer to the **NI High-Speed Digitizers Help** for information about when to self-calibrate the device.

Calibration Specifications

Interval for external calibration	2 years
Warm-up time ^[28]	15 minutes

Software

Driver Software

This device was first supported in NI-SCOPE17.1 and LabVIEW Instrument Design Libraries for Reconfigurable Oscilloscopes17.1. LabVIEW Instrument Design Libraries for Reconfigurable Oscilloscopes is an IVI-compliant driver that allows you to configure, control, and calibrate the device. NI-SCOPE provides application programming interfaces for many development environments.

Application Software

NI-SCOPE provides programming interfaces, documentation, and examples for the following application development environments:

- LabVIEW
- LabWindows™/CVI™
- Measurement Studio
- Microsoft Visual C/C++
- .NET (C# and VB.NET)

Interactive Soft Front Panel and Configuration

When you install NI-SCOPE on a 64-bit system, you can monitor, control, and record measurements from the PXIe-5172 using InstrumentStudio.

InstrumentStudio is a software-based front panel application that allows you to perform interactive measurements on several different device types in a single program.



Note InstrumentStudio is supported only on 64-bit systems. If you are using a 32-bit system, use the NI-SCOPE-specific soft front panel instead of InstrumentStudio.

Interactive control of the PXIe-5172 was first available via InstrumentStudio in NI-SCOPE18.1 and via the NI-SCOPE SFP in NI-SCOPE17.1. InstrumentStudio and the NI-SCOPE SFP are included on the NI-SCOPE media.

NI Measurement & Automation Explorer (MAX) also provides interactive configuration and test tools for the PXIe-5172. MAX is included on the driver media.

TClk Specifications

You can use the NI TClk synchronization method and the NI-TClk driver to align the Sample clocks on any number of supported devices, in one or more chassis. For more information about TClk synchronization, refer to the **NI-TClk Synchronization**

Help, which is located within the **NI High-Speed Digitizers Help**. For other configurations, including multichassis systems, contact NI Technical Support at ni.com/support.

Intermodule Synchronization Using NI-TClk for Identical Modules

Synchronization specifications are valid under the following conditions:

- All modules are installed in one PXI Express chassis.
- The NI-TClk driver is used to align the Sample clocks of each module.
- All parameters are set to identical values for each SMC-based module.
- Modules are synchronized without using an external Sample clock.
- Self-calibration is completed.



Note Although you can use NI-TClk to synchronize non-identical modules, these specifications apply only to synchronizing identical modules.

Skew ^[29]	300 ps
Skew after manual adjustment	≤10 ps
Sample clock delay/adjustment resolution	3.5 ps

Power



Note Power consumed depends on the FPGA image and driver software used. Specifications for instrument design libraries reflect the performance of a device using the FPGA image from the Multirecord Acquisition sample project. Maximum power consumption occurs at the highest operating temperature.

PXIe-5172 (4 CH) power consumption

+3.3 V DC	6.5 W, typical
+12 V DC	13.75 W, typical
Total power	20.25 W, typical
PXIe-5172 (8 CH) power consumption	
+3.3 V DC	8.5 W, typical
+12 V DC	18 W, typical
Total power	26.5 W, typical
Total maximum power allowed	38.25 W

Physical

Dimensions	3U, one-slot, PXI Express Gen 2 x8 Module 18.5 cm × 2.0 cm × 13.0 cm (7.3 in × 0.8 in × 5.1 in)
Weight	
PXIe-5172 (4 CH)	449 g (15.8 oz)
PXIe-5172 (8 CH)	461 g (16.3 oz)

Environment

Maximum altitude	2,000 m (800 mbar) (at 25 °C ambient temperature)
Pollution Degree	2

Indoor use only.

Operating Environment

Ambient temperature range	0 °C to 45 °C
Relative humidity range	10% to 90%, noncondensing

Storage Environment

Ambient temperature range	-40 °C to 71 °C
Relative humidity range	5% to 95%, noncondensing

Shock and Vibration

Operating shock	30 g peak, half-sine, 11 ms pulse
Random vibration	
Operating	5 Hz to 500 Hz, 0.3 grms
Nonoperating	5 Hz to 500 Hz, 2.4 grms

Compliance and Certifications

Safety Compliance Standards

This product is designed to meet the requirements of the following electrical equipment safety standards for measurement, control, and laboratory use:

- IEC 61010-1, EN 61010-1
- UL 61010-1, CSA C22.2 No. 61010-1



Note For UL and other safety certifications, refer to the product label or the [Product Certifications and Declarations](#) section.

Electromagnetic Compatibility

This product meets the requirements of the following EMC standards for electrical equipment for measurement, control, and laboratory use:

- EN 61326-1 (IEC 61326-1): Class A emissions; Basic immunity
- EN 55011 (CISPR 11): Group 1, Class A emissions
- EN 55022 (CISPR 22): Class A emissions
- EN 55024 (CISPR 24): Immunity
- AS/NZS CISPR 11: Group 1, Class A emissions
- AS/NZS CISPR 22: Class A emissions
- FCC 47 CFR Part 15B: Class A emissions
- ICES-001: Class A emissions



Note In the United States (per FCC 47 CFR), Class A equipment is intended for use in commercial, light-industrial, and heavy-industrial locations. In Europe, Canada, Australia, and New Zealand (per CISPR 11), Class A equipment is intended for use only in heavy-industrial locations.



Note Group 1 equipment (per CISPR 11) is any industrial, scientific, or medical equipment that does not intentionally generate radio frequency energy for the treatment of material or inspection/analysis purposes.



Note For EMC declarations, certifications, and additional information, refer to the [Product Certifications and Declarations](#) section.

CE Compliance

This product meets the essential requirements of applicable European Directives, as follows:

- 2014/35/EU; Low-Voltage Directive (safety)
- 2014/30/EU; Electromagnetic Compatibility Directive (EMC)
- 2011/65/EU; Restriction of Hazardous Substances (RoHS)

Product Certifications and Declarations

Refer to the product Declaration of Conformity (DoC) for additional regulatory compliance information. To obtain product certifications and the DoC for NI products, visit ni.com/product-certifications, search by model number, and click the appropriate link.

Environmental Management

NI is committed to designing and manufacturing products in an environmentally responsible manner. NI recognizes that eliminating certain hazardous substances from our products is beneficial to the environment and to NI customers.

For additional environmental information, refer to the **Engineering a Healthy Planet** web page at ni.com/environment. This page contains the environmental regulations and directives with which NI complies, as well as other environmental information not included in this document.

EU and UK Customers

-  Waste Electrical and Electronic Equipment (WEEE)—At the end of the product life cycle, all NI products must be disposed of according to local laws and regulations. For more information about how to recycle NI products in your region, visit ni.com/environment/weee.

电子信息产品污染控制管理办法 (中国 RoHS)

-  中国 RoHS— NI 符合中国电子信息产品中限制使用某些有害物质指令(RoHS)。关于 NI 中国 RoHS 合规性信息，请登录 ni.com/environment/rohs_china。(For information about China RoHS compliance, go to ni.com/environment/rohs_china.)

¹ Warm-up begins after the chassis and controller or PC is powered, the PXIe-5172 is recognized by the host, and the PXIe-5172 is configured using the instrument design libraries or NI-SCOPE. In some RIO applications, the power consumed by the PXIe-5172 can be significantly higher than the default image for the module. In these cases, you can improve performance by loading your image and configuring the device before warm-up time begins. Self-calibration is recommended following the specified warm-up time.

² For more information about cooling, refer to the **Maintain Forced-Air Cooling Note to Users** available at ni.com/manuals.

³ Derated to $5 V_{pk-pk}$ for periodic waveforms with frequencies below 100 kHz.

⁴ Within $\pm 5^\circ\text{C}$ of self-calibration temperature. Accuracy is warranted only when using DC input coupling.

⁵ Used to calculate errors when onboard temperature changes more than $\pm 5^\circ\text{C}$ from the self-calibration temperature.

⁶ A **conversion error** is defined as deviation greater than 0.6% of full scale.

7 Measured on one channel with test signal applied to another channel, with the same range setting on both channels.

8 Normalized to 50 kHz.

9 Verified using a 50 Ω source and 50 Ω feedthrough terminator.

10 Only available using NI-SCOPE.

11 Available at sample rates ≥ 200 MS/s.

12 Verified using a 50 Ω source.

13 50% FS input pulse.

14 For 1 M Ω , verified using a 50 Ω source and 50 Ω feedthrough terminator.

15 -1 dBFS input signal corrected to FS. 358 Hz resolution bandwidth.

16 -1 dBFS input signal corrected to FS. Includes the 2nd through the 5th harmonics.

17 Verified using a 50 Ω terminator connected to input.

18 For input frequencies <90 MHz.

19 Divide by **n** decimation from 250 MS/s. For more information about the sample clock and decimation, refer to the **NI Reconfigurable Oscilloscopes Help** at ni.com/manuals.

20 Integrated from 100 Hz to 10 MHz. Includes the effects of the converter aperture uncertainty and the clock circuitry jitter.

21 Used to calculate additional DC accuracy error when using a base sample clock that is less than 250 MHz. To calculate the additional error, take the difference of the base sample clock rate from 250 MHz, divide by 1,000,000, and multiply by the DC accuracy sampling drift.

22 The PLL reference clock must be accurate to ± 25 ppm.

23 The PLL reference clock must be accurate to ± 25 ppm.

24 Trigger specifications are always valid when programming with NI-SCOPE. When programming with the instrument design libraries, trigger specifications are valid only if the design of the custom triggers, as implemented in an FPGA bitfile, is sufficient to meet the specifications.

25 For input frequencies < 90 MHz.

26 Data must exceed each corresponding trigger threshold for at least the minimum duration to ensure analog triggering.

27 Onboard memory is shared among all enabled channels.

28 Warm-up begins after the chassis and controller or PC is powered, the PXIe-5172 is recognized by the host, and the PXIe-5172 is configured using the instrument design libraries or NI-SCOPE. In some RIO applications, the power consumed by the PXIe-5172 can be significantly higher than the default image for the module. In these cases, you can improve performance by loading your image and configuring the device before warm-up time begins. Self-calibration is recommended following the specified warm-up time.

29 Caused by clock and analog path delay differences. No manual adjustment performed. Tested with a PXIe-1082 chassis with a maximum slot-to-slot skew of 100 ps. Valid within ± 1 °C of self-calibration.



Ihr Ansprechpartner /
Your Partner:

dataTec AG
E-Mail: info@datatec.eu
>>> www.datatec.eu

